



**HAL**  
open science

# Villermoux–Dushman Test of Micromixing Characterization Revisited: Kinetic Effects of Acid Choice and Ionic Strength

Pierrette Guichardon, Carlos Baqueiro, Nelson Ibaseta

## ► To cite this version:

Pierrette Guichardon, Carlos Baqueiro, Nelson Ibaseta. Villermoux–Dushman Test of Micromixing Characterization Revisited: Kinetic Effects of Acid Choice and Ionic Strength. *Industrial and engineering chemistry research*, 2021, 60 (50), pp.18268-18282. <10.1021/acs.iecr.1c03208>. <hal-03597451>

**HAL Id: hal-03597451**

**<https://hal.science/hal-03597451v1>**

Submitted on 4 Mar 2022

**HAL** is a multi-disciplinary open access archive for the deposit and dissemination of scientific research documents, whether they are published or not. The documents may come from teaching and research institutions in France or abroad, or from public or private research centers.

L'archive ouverte pluridisciplinaire **HAL**, est destinée au dépôt et à la diffusion de documents scientifiques de niveau recherche, publiés ou non, émanant des établissements d'enseignement et de recherche français ou étrangers, des laboratoires publics ou privés.



HAL Authorization

# Villiermaux–Dushman Test of Micromixing Characterization Revisited: Kinetic Effects of Acid Choice and Ionic Strength

Pierrette Guichardon,\* Carlos Baqueiro, and Nelson Ibaseta

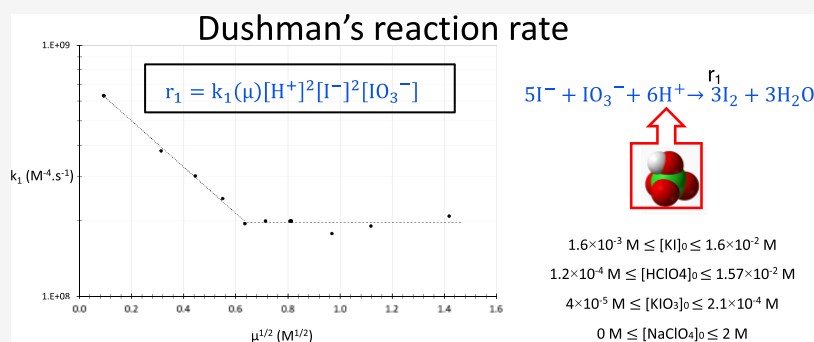

**ABSTRACT:** The well-known Villiermaux–Dushman system is nowadays widely used for examining the micromixing efficiency either in batch or continuous intensified reactors. However, a bibliographic review shows that kinetic data are too scattered for a reliable determination of the micromixing times. The Dushman reaction kinetics is then reexamined with the use of sulfuric and perchloric acids. The results confirm the fifth-order rate law. More precisely, the  $\text{I}^-$ ,  $\text{H}^+$ , and  $\text{IO}_3^-$  dependence orders on the rate law are, respectively, 2, 2, and 1, under any condition. To be more consistent with the reactant concentrations used in the Villiermaux–Dushman test, we extend their studied range, namely,  $1.6 \times 10^{-3} \text{ M} \leq [\text{I}^-]_0 \leq 1.6 \times 10^{-2} \text{ M}$ ,  $1.2 \times 10^{-4} \text{ M} \leq [\text{H}^+]_0 \leq 1.57 \times 10^{-2} \text{ M}$ , and  $4 \times 10^{-5} \text{ M} \leq [\text{IO}_3^-]_0 \leq 2.1 \times 10^{-4} \text{ M}$ . The ionic strength varies up to 2 M. The experimental results show that the rate constant is still ionic-strength-dependent. The results obtained with sulfuric and perchloric acids are found to be consistent and in relatively good agreement at small ionic strengths ( $\mu \leq 0.1 \text{ M}$ ) only. At a higher ionic strength, the use of sulfuric acid requires sustained attention to the constant of the second dissociation equilibrium. The nonideal solution behavior raising at a high ionic strength makes its estimation deeply sensitive.

## 1. INTRODUCTION AND BIBLIOGRAPHIC REVIEW

The so-called Dushman reaction is involved in the Villiermaux–Dushman system, composed of rapid multiple reactions, which has a product distribution particularly sensitive to the micromixing (mixing at the molecular scale).

This peculiar system is nowadays widely used for examining the micromixing efficiency either in batch reactors or continuous mixers. It was developed in the 1990s by Villiermaux's team in Nancy.<sup>1–4</sup> The Dushman [reaction r1](#) generally linked with [equilibrium r2](#) according to

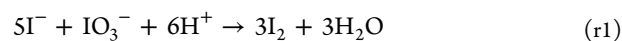

is then coupled with a neutralization reaction to form a competitive-parallel reactions system. When aiming to determine the micromixing times with this tool, it is needed to analyze the experimental results in the light of the micromixing models, where the kinetic data are incorporated. The micromixing times thus determined are to a large extent

sensitive to the reaction rate, the reliability of which is of the utmost importance.

The first kinetic investigation of [reaction r1](#) has been carried out by Dushman.<sup>5</sup> Ever since, various contributions have proposed numerous scattered kinetic data, and the confusion surrounding this venerable reaction is still current. The different rate laws for  $r_1$ , the Dushman reaction rate, as proposed in the literature are summarized in [Table 1](#).

Note that some of the data are directly extracted from the first proposed exhaustive draft drawn up by Cantrel.<sup>6</sup> In [Table 1](#), particular attention has been given to recall the main operating conditions such as the kind of acid used and the concentration range of the reagents. The proposed rates were

**Table 1. Different Kinds of Rate Laws Proposed in the Literature since 1904<sup>b</sup>**

rate law	rate law number	reference	pH	main reagents	[I <sup>-</sup> ] (M)	[IO <sub>3</sub> <sup>-</sup> ] (M)	μ (M) <sup>a</sup>
Form 1: The fourth-order laws							
405 [IO <sub>3</sub> <sup>-</sup> ] [I <sup>-</sup> ][H <sup>+</sup> ] <sup>2</sup>	(1.1)	Abel and Hilferding, <sup>7</sup> 1928	<1	AgI, AgIO <sub>3</sub> , H <sub>2</sub> SO <sub>4</sub>	10 <sup>-10</sup> to 2 × 10 <sup>-9</sup>	0.5–1.2	
1831 [IO <sub>3</sub> <sup>-</sup> ] [I <sup>-</sup> ][H <sup>+</sup> ] <sup>2</sup> T = 25 °C	(1.2)	Furuchi et al., <sup>8</sup> 1972		HClO <sub>4</sub> , AgI, AgIO <sub>3</sub> , HIO <sub>3</sub>	10 <sup>-7</sup>		
1432 [IO <sub>3</sub> <sup>-</sup> ] [I <sup>-</sup> ][H <sup>+</sup> ] <sup>2</sup> T = 25 °C	(1.3)	Furuchi and Liebafsky, <sup>9</sup> 1975		AgI, AgNO <sub>3</sub> , HIO <sub>3</sub> , LiClO <sub>4</sub>	10 <sup>-9</sup>	5 × 10 <sup>-3</sup>	0.09–0.33
negative effect of ionic strength							
Form 2: The fifth-order laws							
9 × 10 <sup>8</sup> [IO <sub>3</sub> <sup>-</sup> ] [I <sup>-</sup> ] <sup>2</sup> [H <sup>+</sup> ] <sup>2</sup>	(2.1)	Sand and Kaestle, <sup>10</sup> 1907	4	CH <sub>3</sub> COOH	0.1–0.3	0.01–0.5	
k <sub>1</sub> (μ) [IO <sub>3</sub> <sup>-</sup> ] [I <sup>-</sup> ] <sup>2</sup> [H <sup>+</sup> ] <sup>2</sup>	(2.2)	Indelli, <sup>11</sup> 1960	3–3.6	HNO <sub>3</sub> NaNO <sub>3</sub> , KCl, KNO <sub>3</sub> , KClO <sub>4</sub> , Na <sub>2</sub> SO <sub>4</sub> , K <sub>2</sub> SO <sub>4</sub> , Ca(NO <sub>3</sub> ) <sub>2</sub> , etc.	(2–7.5) × 10 <sup>-4</sup>	(4–8) × 10 <sup>-3</sup>	0.00096–0.04
low negative effect of ionic strength							
8.9 × 10 <sup>8</sup> [IO <sub>3</sub> <sup>-</sup> ] [I <sup>-</sup> ] <sup>2</sup> [H <sup>+</sup> ] <sup>2</sup>	(2.3)	Haberland and Landsberg, <sup>12</sup>					
6.5 × 10 <sup>8</sup> [IO <sub>3</sub> <sup>-</sup> ] [I <sup>-</sup> ] <sup>2</sup> [H <sup>+</sup> ] <sup>2</sup>	(2.4)	Hasty, <sup>13</sup> 1973	2	H <sub>2</sub> SO <sub>4</sub> , K <sub>2</sub> SO <sub>4</sub>	(1–100) × 10 <sup>-6</sup>	5 × 10 <sup>-3</sup>	0.12
6.3 × 10 <sup>9</sup> [IO <sub>3</sub> <sup>-</sup> ] [I <sup>-</sup> ] <sup>2</sup> [H <sup>+</sup> ] <sup>2</sup> T = 25 °C	(2.5)	Nokolelis et al., <sup>14</sup> 1977	2.3	H <sub>2</sub> SO <sub>4</sub> , Na <sub>2</sub> SO <sub>4</sub> , NaClO <sub>4</sub>	higher than 10 <sup>-4</sup> M	0.05	1
positive effect of ionic strength							
2.62 × 10 <sup>8</sup> [IO <sub>3</sub> <sup>-</sup> ] [I <sup>-</sup> ] <sup>2</sup> [H <sup>+</sup> ] <sup>2</sup>	(2.6)	Palmer and Lyons, <sup>15</sup> 1988					0.1
4.27 × 10 <sup>8</sup> [IO <sub>3</sub> <sup>-</sup> ] [I <sup>-</sup> ] <sup>2</sup> [H <sup>+</sup> ] <sup>2</sup>	(2.7)	Guichardon <sup>3</sup> Guichardon and Falk, <sup>16</sup> 2000	1–2	H <sub>2</sub> SO <sub>4</sub> , Na <sub>2</sub> SO <sub>4</sub> , K <sub>2</sub> SO <sub>4</sub> , KI, KIO <sub>3</sub>	(8–20) × 10 <sup>-4</sup>	(1–7) × 10 <sup>-5</sup>	0.016–2
for μ < 0.016 M log <sub>10</sub> k <sub>1</sub> = 9.281–3.664√μ							
for μ > 0.016 M log <sub>10</sub> k <sub>1</sub> = 8.383 – 1.511√μ + 0.237μ							
2.8 × 10 <sup>8</sup> [IO <sub>3</sub> <sup>-</sup> ] [I <sup>-</sup> ] <sup>2</sup> [H <sup>+</sup> ] <sup>2</sup>	(2.8)	Xie et al., <sup>17</sup> 1999	0.7–2	HClO <sub>4</sub> , NaClO <sub>4</sub> , NaI, NaIO <sub>3</sub> ,	(3–50) × 10 <sup>-2</sup>	5.3 × 10 <sup>-5</sup>	0.5
log <sub>10</sub> k <sub>1</sub> = log <sub>10</sub> (1.17 × 10 <sup>9</sup> ) – 4 $\frac{0.51 \sqrt{\mu}}{1 + 1.49 \sqrt{\mu}}$		Schmitz et al., <sup>18</sup> 2018		KI, KIO <sub>3</sub> , HClO <sub>4</sub>	higher than 10 <sup>-6</sup> M		0–0.2
1.12 × 10 <sup>9</sup> γ <sup>4</sup> [IO <sub>3</sub> <sup>-</sup> ] [I <sup>-</sup> ] <sup>2</sup> [H <sup>+</sup> ] <sup>2</sup>	(2.9)	Manzano Martinez et al., <sup>19</sup> 2020	0–4.6	KI, KIO <sub>3</sub> , HClO <sub>4</sub> , NaClO <sub>4</sub>	2.5 × 10 <sup>-4</sup> to 1	4 × 10 <sup>-6</sup> to 1	2.5 × 10 <sup>-5</sup> to 1
log <sub>10</sub> (γ) = –0.51 $\frac{\sqrt{\mu}}{1 + \sqrt{\mu}}$ + $\frac{(0.06 + 0.6 \times 0.01347\mu)}{(1 + 1.54\mu)}$ + 0.01347μ							
log <sub>10</sub> k <sub>1</sub> = 9.03(±0.017) – 1.43(±0.058)√μ + 0.90(±0.042)μ		Arian et al., <sup>20</sup> 2021	2.5–3	KI, KIO <sub>3</sub> , HClO <sub>4</sub> , NaClO <sub>4</sub>	(8.3–2.5) × 10 <sup>-4</sup>	(1–2.5) × 10 <sup>-4</sup>	2.5 × 10 <sup>-3</sup> to 1.6
Form 3: The sixth-order laws							
1.3 × 10 <sup>9</sup> [IO <sub>3</sub> <sup>-</sup> ] [I <sup>-</sup> ][H <sup>+</sup> ] <sup>3</sup> [Cl <sup>-</sup> ]	(3.1)	Wronska and Banas, <sup>21</sup> 1965		HCl–KCl			0.3–0.7
positive effect of ionic strength							
1.7 × 10 <sup>9</sup> [IO <sub>3</sub> <sup>-</sup> ] [I <sup>-</sup> ] <sup>2</sup> [H <sup>+</sup> ] <sup>3</sup>	(3.2)	Beran and Bruckenstein, <sup>22</sup> 1968	1–1.3	HCl–ICl	10 <sup>-2</sup> to 10 <sup>-1</sup>	10 <sup>-3</sup>	
Form 4: The two-term rate laws							
4.2 × 10 <sup>8</sup> [IO <sub>3</sub> <sup>-</sup> ] [I <sup>-</sup> ] <sup>1.9</sup> [H <sup>+</sup> ] <sup>2</sup> + 2.8 × 10 <sup>8</sup> [IO <sub>3</sub> <sup>-</sup> ] [I <sup>-</sup> ][H <sup>+</sup> ] <sup>2</sup> [I <sub>3</sub> <sup>-</sup> ]	(4.1)	Dushman, <sup>5</sup> 1904	3–5	CH <sub>3</sub> COOH, CH <sub>3</sub> COONa	(2–20) × 10 <sup>-4</sup>	(2–20) × 10 <sup>-5</sup>	<0.02
1.4 × 10 <sup>8</sup> [IO <sub>3</sub> <sup>-</sup> ] [I <sup>-</sup> ] <sup>1.9</sup> [H <sup>+</sup> ] <sup>3</sup> + 0.5 × 10 <sup>8</sup> [IO <sub>3</sub> <sup>-</sup> ] [I <sup>-</sup> ][H <sup>+</sup> ] <sup>2</sup> [I <sub>3</sub> <sup>-</sup> ]	(4.2)		3–5	HI–HIO <sub>3</sub>			
12.7 × 10 <sup>8</sup> [IO <sub>3</sub> <sup>-</sup> ] [I <sup>-</sup> ] <sup>2</sup> [H <sup>+</sup> ] <sup>2</sup> + 9.2 × 10 <sup>8</sup> [IO <sub>3</sub> <sup>-</sup> ] [I <sup>-</sup> ][H <sup>+</sup> ] <sup>2</sup> [I <sub>3</sub> <sup>-</sup> ]	(4.3)	Abel and Staedler, <sup>23</sup> 1926	1–5	HIO <sub>3</sub> , HI, H <sub>2</sub> SO <sub>4</sub> , K <sub>2</sub> SO <sub>4</sub>	(2–3) × 10 <sup>-3</sup>	(4.7–6.4) × 10 <sup>-4</sup>	0–2

**Table 1. continued**

rate law	rate law number	reference	pH	main reagents	[I <sup>-</sup> ] (M)	[IO <sub>3</sub> <sup>-</sup> ] (M)	μ (M) <sup>a</sup>
Form 4: The two-term rate laws							
$4.2 \times 10^8 [\text{IO}_3^-] [\text{I}^-]^{1.9} [\text{H}^+]^2 + 2.8 \times 10^8 [\text{IO}_3^-] [\text{I}^-] \frac{[\text{H}^+]^2 [\text{I}_3^-]}{[\text{H}^+]^2 [\text{I}_3^-]}$	(4.4)		1–5	acetic acid, sodium acetate			
$5.7 \times 10^6 [\text{IO}_3^-]^2 [\text{I}^-] [\text{H}^+]^3 + 0.11 \times 10^6 [\text{IO}_3^-]^2 [\text{I}^-] \frac{[\text{H}^+]^3 [\text{ClO}_4^-]}{[\text{H}^+]^3 [\text{ClO}_4^-]}$	(4.5)	Myers and Kennedy, <sup>24</sup> 1950	1–2	HIO <sub>3</sub> –HClO <sub>4</sub>			0.001–1
$5.1 \times 10^9 [\text{IO}_3^-] [\text{I}^-]^2 [\text{H}^+]^2 + 4 \times 10^5 [\text{IO}_3^-] [\text{I}^-] [\text{H}^+]^2$	(4.6)	Beran and Bruckenstein, <sup>22</sup> 1968	1–1.3	HClO <sub>4</sub> , ICl, I <sub>2</sub>		$(1-100) \times 10^{-4}$	0.5
$3 \times 10^8 [\text{IO}_3^-] [\text{I}^-]^2 [\text{H}^+]^2 + k[\text{B}^-] [\text{IO}_3^-] [\text{I}^-]^2 [\text{H}^+]^2 / [1 + k[\text{I}^-]]$	(4.7.1)	Barton and Wright, <sup>25</sup> 1968	2.2–6.3	HClO <sub>4</sub> , carboxylate and phosphate ions	$(2-500) \times 10^{-4}$	$(4-300) \times 10^{-5}$	1
$\text{B}^- = \text{H}_2\text{PO}_4^-$ $k = 1.7 \times 10^9$ $k' = 0$	(4.7.2)						
$\text{B}^- = \text{HPO}_4^{2-}$ $k = 0.4 \times 10^9$ $k' = 0$	(4.7.3)						
$\text{B}^- = \text{CH}_3\text{CO}_2^-$ $k = 6.1 \times 10^9$ $k' = 54$							
Positive effect of ionic strength							
$3 \times 10^8 [\text{IO}_3^-] [\text{I}^-]^2 [\text{H}^+]^2 + 8 \times 10^{10} [\text{IO}_3^-]^2 [\text{I}^-]^4 [\text{H}^+]$	(4.9)	Schilderout and Fortuno, <sup>27</sup> 1975	4–5.2	acetic acid, potassium acetate	$3 \times 10^{-3}$ to $2 \times 10^{-4}$ – $10^{-2}$	$2 \times 10^{-3}$ – $10^{-3}$	
$4.2 \times 10^8 [\text{IO}_3^-] [\text{I}^-]^2 [\text{H}^+]^2 + 2.5 \times 10^6 [\text{IO}_3^-] [\text{I}^-] [\text{H}^+]^2$	(4.10)	Cantrel, <sup>6</sup> 1997	1	H <sub>2</sub> SO <sub>4</sub> , KI, KIO <sub>3</sub>	$6.3 \times 10^{-7}$ – $3.8 \times 10^{-5}$	$10^{-4}$ to $5 \times 10^{-2}$	0.12
$4.1 \times 10^8 [\text{IO}_3^-] [\text{I}^-]^2 [\text{H}^+]^2 + 661 [\text{IO}_3^-] [\text{I}^-] [\text{H}^+]^2$	(4.11)	Schmitz, <sup>28</sup> 1999		Schilderout's results	$3 \times 10^{-3}$ – $2 \times 10^{-2}$		0.2
$3.2 \times 10^8 [\text{IO}_3^-] [\text{I}^-]^2 [\text{H}^+]^2 + k[\text{B}^-] [\text{IO}_3^-] [\text{I}^-]^2 [\text{H}^+]^2 / [1 + k[\text{I}^-]]$	(4.12)	Schmitz, <sup>29</sup> 2000	1–2	acetic acid, potassium acetate	$(2-560) \times 10^{-8}$	$(5.2-29) \times 10^{-3}$	0.2
$T = 25^\circ\text{C}$ $\text{B}^- = \text{CH}_3\text{CO}_2^-$ $k = 7.3 \times 10^9$ $k' = 360$				HClO <sub>4</sub> , KClO <sub>4</sub> , KI, KIO <sub>3</sub>			
$4.2 \times 10^8 [\text{IO}_3^-] [\text{I}^-]^2 [\text{H}^+]^2 + 1200 [\text{IO}_3^-] [\text{I}^-] [\text{H}^+]^2$	(4.13)	Agreda, <sup>30</sup> 2000	0.3–1	HClO <sub>4</sub> , KI, KIO <sub>3</sub> , HIO <sub>3</sub>	$5.8 \times 10^{-5}$	$(2.1-45) \times 10^{-4}$	
$1.6 \times 10^8 \frac{[\text{HClO}_3]_0 [\text{HClO}_3]_0 [\text{I}^-]^2}{[\text{HClO}_3]_0^2} + 990 [\text{HClO}_3]_0$	(4.14)	Valkai and Horvath, <sup>31</sup> 2016	0.3–1.3	HClO <sub>4</sub> , NaClO <sub>4</sub> , Na <sub>2</sub> SO <sub>4</sub> , NaI, NaIO <sub>3</sub> , I <sub>2</sub>	$(16-87.5) \times 10^{-6}$	$(0.5-2) \times 10^{-3}$	0.68
$k_1 [\text{IO}_3^-] [\text{I}^-]^2 [\text{H}^+]^2 + k_2 [\text{IO}_3^-] [\text{I}^-] [\text{H}^+]^2$	(5.1)	Kölbl et al., <sup>32</sup> 2012		HClO <sub>4</sub> , H <sub>2</sub> SO <sub>4</sub> , KI, KIO <sub>3</sub> , NaH <sub>2</sub> BO <sub>3</sub> , NaOH, BaNIO <sub>3</sub> , NaNIO <sub>3</sub> , NaClO <sub>4</sub> , Na <sub>2</sub> SO <sub>4</sub>	$(1-8) \times 10^{-2}$	$2 \times 10^{-3}$	0.1
$0.77 \times 10^8 < k_1 < 2.18 \times 10^8$ $2230 < k_2 < 2420$	(5.2)	Kölbl et al., <sup>33</sup> 2013		HClO <sub>4</sub> , H <sub>2</sub> SO <sub>4</sub> , KI, KIO <sub>3</sub> , NaH <sub>2</sub> BO <sub>3</sub> , NaOH, Na <sub>2</sub> SO <sub>4</sub> , NaNIO <sub>3</sub>	$4 \times 10^{-2}$	$8 \times 10^{-3}$	0.25–2.25
Form 5: Other kinds of rate law							
$k [\text{IO}_3^-]^{10.6} [\text{I}^-]^{1.4} [\text{H}^+]^{0.62}$							
no $k$ value was proposed, no influence of ionic strength							
$k [\text{IO}_3^-] [\text{I}^-]^2 [\text{H}^+]^{1.3}$							
no $k$ value was proposed, no influence of ionic strength							

<sup>a</sup>μ is the ionic strength defined as:  $\mu = 1/2 \sum z_i^2 C_i$ . <sup>b</sup>Where  $z_i$  and  $C_i$  are the charge and concentration of ion  $i$ , respectively.

put away into five different kinds of kinetic laws. Forms 1, 2, 3, and 5 gather the one-term rate laws, while form 4 concerns the two-term rate laws.

Dushman's reaction story started in 1904, and the confusion has raised because the reaction involves different reactive intermediate species, which were identified only belatedly. In addition, the literature reports a lot of data on different reagents that have been used in concentration ranges that are too scattered to be compared. This situation is obviously due to the complexity of the chemical system and the difficulty of the experimental investigation in this case of a very fast reaction. Fortunately, many pieces of the puzzle are now about to find their place.

Regarding the partial kinetic orders, certain marginal results<sup>21,22,32–34</sup> were published. It is worth noting that the approach of determining partial kinetic orders from micromixing experiments seems questionable. All kinetic results obtained by this way<sup>32–34</sup> seem rather marginal in comparison with all others published. Each paper led to different partial orders. For instance, according to Kölbl's studies, the partial order related to  $H^+$  is 0.6 for a stirred tank reactor and becomes 1.3 for a microstructured mixer, whereas Wenzel found 2.68 in a stirred reactor. Not only this high variation range seems deeply questionable but also kinetics appears to be reactor-type-dependent. The determination of kinetic data through micromixing experiments needs to be carefully checked because they may be mixing-condition-dependent.

Apart from these studies, all investigations agree that  $H^+$  and  $IO_3^-$  dependences on rate law are, respectively, 2 and 1, under all conditions. The iodide dependence was the subject of a long controversy, but most of the studies provided experimental evidence that the rate order only depends on the iodide concentration range. The order is 1 at a small iodide concentration<sup>6–9,24,27,29,31</sup> (i.e., less than  $5 \times 10^{-7}$  M), while it becomes 2 at concentrations between  $5 \times 10^{-6}$  M and  $10^{-3}$  M.<sup>5,6,10–17,22–24,27,28,31</sup> At a much higher concentration,<sup>29</sup> it may be less than 2. All of these results are consistent with the fully accepted mechanism, which highlights the importance of the intermediate species  $I_2O_2$  or its equivalent hydrated form  $H_2I_2O_3$ , as written by the following mechanism<sup>31</sup>

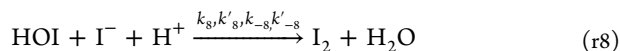
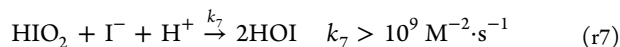
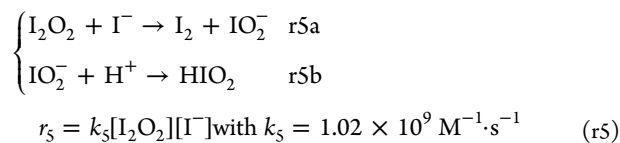
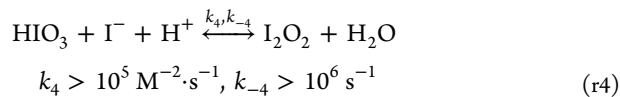
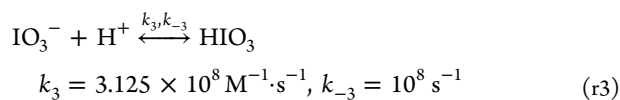

With

$$r_8 = k_8[HOI][I^-] + k'_8[HOI][I^-][H^+] - k_8[I_2]/[H^+] - k'_{-8}[I_2]$$

$$k_8 = 3.67 \times 10^9 \text{ M}^{-1} \cdot \text{s}^{-1}, k'_8 = 1.023 \times 10^{11}$$

$$\text{M}^{-2} \cdot \text{s}^{-1}, k_{-8} = 0.00198 \text{ M}^{-1} \cdot \text{s}^{-1}, k'_{-8} = 0.0552 \text{ s}^{-1}$$

The first step, which involves the dissociation equilibrium of iodic acid {eq r3}, has been early proposed<sup>24,35</sup> with the suggestion that the electron-deficient iodyl cation  $IO_2^+$  is an intermediate species. Later, Barton and Wright<sup>25</sup> dismissed this assumption after finding that it was inconsistent with the experimentally revealed catalytic effect of the nucleophiles on the reaction rate and they hence imagined  $I_2O_2$  as an intermediate instead of  $IO_2^+$ . One can note that the role of  $I_2O_2$  in the mechanism was first proposed by Bray in 1930.<sup>36</sup> In 1975, a first mechanism underlining the important role of  $I_2O_2$  was developed by Schildcrout and Barton<sup>26,27</sup> and later completed by Schmitz and Valkai.<sup>29,31</sup>  $I_2O_2$  has since been considered as a well-identified intermediate species, and not as an activated complex.

On the other side, Schmitz<sup>29</sup> pointed out that the rate constants of both steps r5 and r6 depend on the buffer concentration and on the nature of medium.

From mechanism r3–r8 and after some algebraic manipulations along with certain simplifications ( $k_4 \gg k_5[I^-]$  and  $k_4 \gg k_6[H^+]$ ), Valkai<sup>31</sup> arrived at the following equation for reaction rate  $r_1$

$$r_1 = \left( \frac{k_4 k_5 [I^-]}{k_{-4}} + \frac{k_4 k_6}{k_{-4}} \right) [I^-][H^+][HIO_3] \quad (1)$$

It is also worth noting that the idea consisting in adding the contribution from  $I_3^-$  in the reaction rate at high concentrations<sup>5,23</sup> has eventually been given up over the years.

Another manner to act on kinetics has been pointed out: a catalytic effect of carboxylate and phosphate ions such as  $H_2PO_4^-$ ,  $HPO_4^{2-}$ ,  $CH_3CO_2^-$ , and other ions has been found to occur.<sup>25</sup>

The ionic strength ( $\mu$ ) has also a marked effect on the reaction rate, but the overall opinion has not yet converged toward a shared consensus. The effect of salt on the reaction was first studied by Wronska<sup>21</sup> when adding KCl: an increase in the rate with the ionic strength was found. However, these results must be taken with certain precautions because acetate and phosphate buffers and HCl were used: for these ions, we actually know that acetate and phosphate ions can catalyze the reaction<sup>25</sup> and that  $Cl^-$  may enhance iodate reduction reaction.<sup>14,22</sup> On the contrary, most of the works observed that an increase in  $\mu$  led to a decrease in rate. The effect of 12 different salts has been investigated by Indelli.<sup>11</sup> For the univalent and divalent anions and cations, the study showed a low effect with a closer conformity to the Brönsted–Debye equation. A larger decrease in rate was also reported when adding sulfate ions and explained by the possible formation of  $HSO_4^-$ . A rather low decrease in the rate was also reported when adding  $LiClO_4$ <sup>9</sup> and confirmed later by Guichardon.<sup>3,4</sup> At a small ionic strength ( $\mu < 0.1$  M), this experiment shows that the logarithm of the rate constant decreases linearly with the square root of ionic strength. Increasing  $\mu$  from 1 to 1.1 M causes a reduction of about 11% of the rate. Finally, it is however useful to cite Kölbl's investigations,<sup>32,33</sup> where no significant influence of the ionic strength was found.

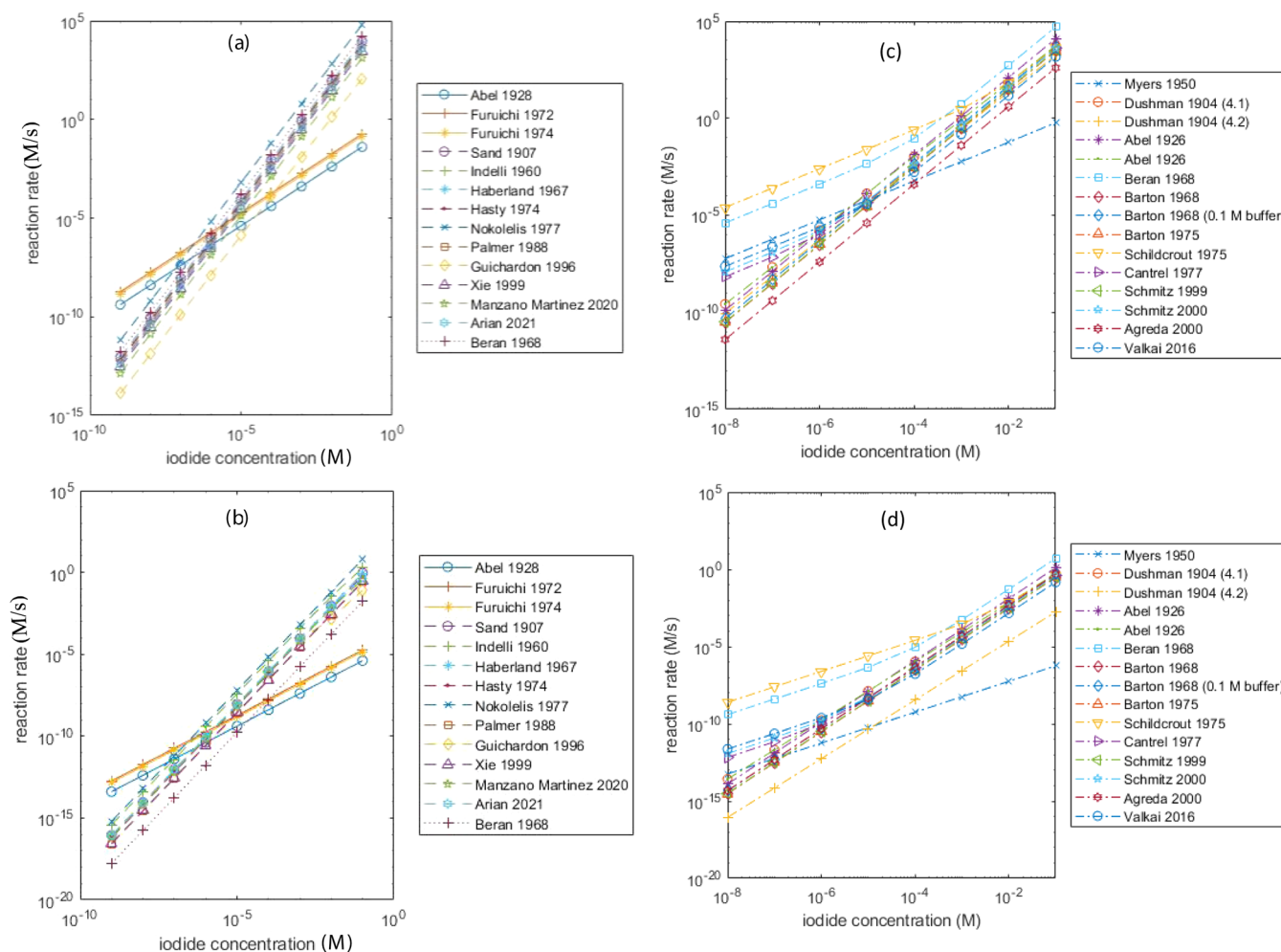

**Figure 1.** Influence of iodide concentration on rate laws (a) forms 1, 2, and 3:  $[\text{IO}_3^-] = 10^{-3} \text{ M}$ ;  $[\text{H}^+] = 1 \text{ M}$ ; (b) forms 1, 2, and 3:  $[\text{IO}_3^-] = 10^{-3} \text{ M}$ ;  $[\text{H}^+] = 0.01 \text{ M}$ ; (c) form 4:  $[\text{IO}_3^-] = 10^{-3} \text{ M}$ ;  $[\text{H}^+] = 1 \text{ M}$ ; and (d) form 4:  $[\text{IO}_3^-] = 10^{-3} \text{ M}$ ;  $[\text{H}^+] = 0.01 \text{ M}$ .

Most of the debate on the types of reagents mainly concerns the choice of the acid. It is important to reject chloride acid and nitrite acid.  $\text{Cl}^-$  ion may have a catalytic effect as previously reported,<sup>14,22,34</sup> and  $\text{NO}_3^-$  ion may be involved in a redox reaction. As the redox potential of the oxidant is of the same order as the one of  $\text{IO}_3^-$  ions,  $\text{NO}_3^-$  may be reduced into NO by the  $\text{I}^-$  ion in an acid medium. Among all of the acids widely used, perchloric acid appears as the most suitable candidate. Perchloric acid is so strong that complete ionization may be assumed ( $\text{p}K_a = -9$ ), while sulfuric acid might not be fully ionized ( $\text{p}K_{a1} = -3$ ,  $\text{p}K_{a2} = 1.99$ ) and its ionization equilibria should be considered. This point is of particular importance when sulfate salt has been added for controlling the ionic strength. If the role of sulfate as a base was neglected,  $[\text{H}^+]$  would be overestimated, and the rate constant thus calculated would be too low. In Dushman's reaction case, where the reaction rate varies with  $[\text{H}^+]$  squared, this effect is of particular importance on the calculated value of the rate constant.

Aiming to compare all of the different forms of kinetic laws, as summarized in Table 1, the present study now calculates and compares the reaction rates as a function of the iodide concentration, which ranges from  $10^{-8}$  to  $10^{-2} \text{ M}$ . We observe that the iodate concentration has no influence on the relative position of these numerous laws and iodate concentration was

then set to  $10^{-3} \text{ M}$ . Two different  $[\text{H}^+]$  were investigated. The main results are presented in Figure 1a,b.

We can easily observe the influence of iodide concentration on the rate law order, thanks to the curve slopes which are 1 and 2 for form 1 and forms 3–4, respectively. The forms of type 1, which have been established for working at a low iodide concentration, give higher reaction rates than forms 3 and 4, when iodide concentration is lower than  $5 \times 10^{-7} \text{ M}$ . This trend is reversed as iodide concentration becomes greater than  $10^{-5} \text{ M}$ . In the intermediate domain ( $5 \times 10^{-7} \text{ M} < [\text{I}^-] < 10^{-5} \text{ M}$ ), all of the reaction rates are of the same order of magnitude. The influence of the  $\text{H}^+$  concentration on the relative position of the various rates is only noticeable in two types of reaction rate laws:

- Guichardon:<sup>3</sup> the higher the  $\text{H}^+$  concentration, the lower the reaction rate as a result of an increase in ionic strength. Note a wrong estimate of  $\text{H}^+$  concentration, as discussed in the rest of the paper.
- Beran and Bruckenstein:<sup>22</sup> a higher  $\text{H}^+$  concentration produces a greater reaction rate, as a result of an order 3 in  $\text{H}^+$  dependence.

Comparing the different forms of type 2 and type 3, a factor of 1000 is obtained between the highest and lowest reaction rates proposed by Nikolelis law and Guichardon or Beran laws, respectively.

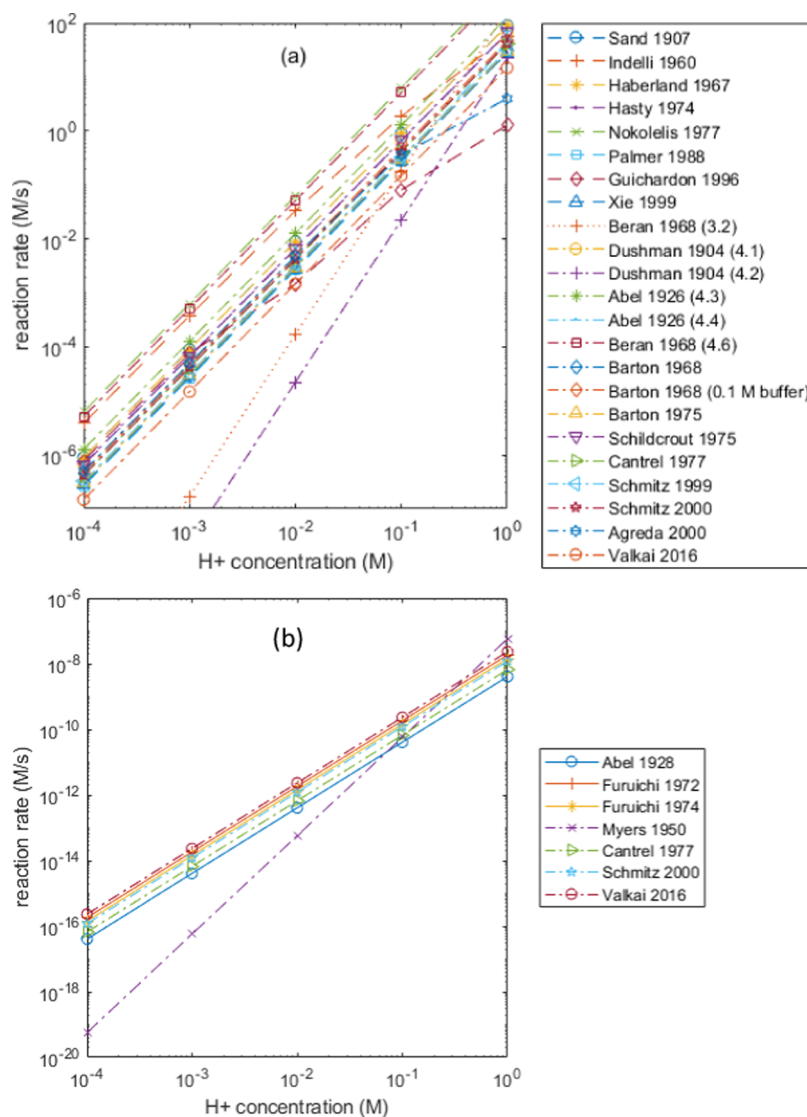

**Figure 2.** Influence of  $H^+$  concentration on rate laws: (a)  $[IO_3^-] = 10^{-5} \text{ M}$ ;  $[I^-] = 0.01 \text{ M}$ ; (b)  $[IO_3^-] = 10^{-5} \text{ M}$ ;  $[I^-] = 10^{-8} \text{ M}$ .

Figure 1c,d concerns the two-term rate laws (form 4) where different iodide dependences on reaction rate are highlighted:

- some reaction rates follow a single-order iodide dependence at any iodide concentration: Myers,<sup>24</sup> Schildcrout,<sup>27</sup> and Beran<sup>22</sup>
- some reaction rates follow a two-order iodide dependence at any iodide concentration: Dushman,<sup>5</sup> Abel,<sup>23</sup> Barton,<sup>25</sup> Barton,<sup>26</sup> Schmitz,<sup>28</sup> and Agrega<sup>30</sup>
- some reaction rates follow a one- or two-order iodide dependence according to whether iodide concentration is low or high: Cantrel,<sup>6</sup> Schmitz,<sup>29</sup> and Valkai<sup>31</sup>

For the sake of clarity, we separately compare—for two different  $H^+$  concentrations—the reaction laws adapted to high iodide concentrations (see Figure 2a) and those specifically developed for smaller iodide concentrations (see Figure 2b).

At a high iodide concentration, the results can be classified into three different classes:

- rate laws offering marginal reaction rate changes: Beran 1968 (3.2), Dushman 1904 (4.2)
- rate laws providing the greatest reaction rate: Beran 1968 (4.6), Nokolelis 1977, Indelli 1960

- all of the other rate laws providing a reaction rate that varies by a factor of less than 10.

At a low iodide concentration, a good agreement between all reaction laws is obtained excluding Meyer's law. A factor of 10 is nevertheless obtained on the reaction rate with respect to all other reaction laws.

Considering all of the published results, disparate values of the reaction rate can be calculated. Nonetheless, it is possible to obtain a good agreement between well-chosen studies:

- some accurate rate laws at a low iodide concentration: Abel 1928, Furuichi 1972, Furuichi 1974, Cantrel 1977, Schmitz 2000, Valkai 2016
- some well-correlated rate laws at a high iodide concentration: Barton 1975, Guichardon 1996, Xie 1999, Schmitz 1999, Agrega 2000, Valkai 2016.

The agreement observed at a low iodide concentration is of poor interest in the context of the Villermaux–Dushman system because the latter method requires high iodide concentrations.

As for the high iodide concentrations, we can consider that a consensus on kinetics data is now available. But this consensus

mostly ignores the effect of the ionic strength. The latter point is an open question. Another reason for the dispersion of results in the literature could be related to the choice of acid. As mentioned above, numerous acids must be rejected because of their catalytic or redox effects. Furthermore, in most of the studies with H<sub>2</sub>SO<sub>4</sub>, the possible partial dissociation was neglected.

The effect of the acid choice is also an important parameter, while we find in the literature studies involving the perchloric acid in the micromixing characterization with the Villermaux–Dushman test.<sup>37,38</sup> Any doubt concerning the kinetics has to be removed to estimate reliable micromixing times via micro-mixing models.

The present investigation aims at studying the influence of acid choice and ionic strength on the kinetics of the Dushman reaction. The current kinetic investigation relies on our previous study using sulfuric acid<sup>16</sup> and on new experiments carried out with perchloric acid as a strong acid. The article is organized as follows. Section 2 is devoted to the revision of prior data, taking carefully into account the partial dissociation of sulfuric acid. Section 3 presents the experimental setup, details the data treatment, and presents all of the results obtained with perchloric acid. In Section 4, the results provided with perchloric acid and sulfuric acid are compared and discussed. The effect of ionic strength and acid kind is then commented. Conclusions and perspectives concern Section 5.

## 2. KINETIC INVESTIGATION WITH THE USE OF SULFURIC ACID

This part concerns our previous kinetic study of the Dushman reaction.<sup>3,16</sup> Those results are here reexamined with the aim of establishing a single-term semiempirical reaction rate law.

In those prior studies, the fifth-order rate law was confirmed, and the rate law has been shown to be written as

$$r_1 = k_1(\mu) [I^-]^2 [H^+]^2 [IO_3^-] \quad (2)$$

where rate constant  $k_1$  was dependent on ionic strength  $\mu$  as follows:

$$\log_{10} k_1 = \begin{cases} 9.2810 - 3.664\sqrt{\mu} & \mu \leq 0.16 \text{ M} \\ 8.383 - 1.5112\sqrt{\mu} + 0.2368\mu & \mu > 0.16 \text{ M} \end{cases} \quad (3)$$

Diluted sulfuric acid, KI, and KIO<sub>3</sub> solutions were used with various concentrations ranging as follows

$$8 \times 10^{-4} \text{ M} \leq [I^-]_0 \leq 2 \times 10^{-3} \text{ M}$$

$$10^{-2} \text{ M} \leq [H^+]_0 \leq 8 \times 10^{-2} \text{ M}$$

$$10^{-5} \text{ M} \leq [IO_3^-]_0 \leq 7 \times 10^{-5} \text{ M}$$

$$0 \text{ M} \leq [K_2SO_4]_0 \leq 0.574 \text{ M}$$

The ionic strength was varied from 0 to 2 M by adding a controlled amount of K<sub>2</sub>SO<sub>4</sub> (note that this parameter remained constant during the experiment).

At a high ionic strength, the influence of activity coefficients on equilibrium 2 may be put in debate. Then, the equilibrium constant  $K_2$  is written as

$$K_2 = \frac{\gamma_{I_3^-} [I_3^-]}{\gamma_{I_1^-} \gamma_{I_2^-} [I_2^-] [I^-]} \quad (4)$$

where  $\gamma_{I_3^-}$ ,  $\gamma_{I_2^-}$  and  $\gamma_{I^-}$  are activity coefficients of I<sub>3</sub><sup>-</sup>, I<sub>2</sub><sup>-</sup>, and I<sup>-</sup>, respectively.

The activity coefficients values have been reported by Palmer<sup>39</sup> at an ionic strength ranging from 0.02 to 6.61 M. The ratio  $\frac{\gamma_{I_3^-}}{\gamma_{I_2^-} \gamma_{I^-}}$  varied from 1.030 to 0.997, which indicates no significant effect of ionic strength on the equilibrium constant  $K_2$ . It seems then reasonable to consider as negligible the influence of activity coefficients on equilibrium 2.

As mentioned above, this result can be criticized insofar as sulfuric acid was considered a strong acid. The partial dissociation of sulfuric acid and the role of sulfate ion as a base were neglected. Not only is this consideration inconsistent with the value of the second acidity constant ( $pK_{a2} = 1.99$ ) but this effect is also increasing with the amount of sulfate salt added, as was observed and underlined by many investigators.<sup>11,32,33</sup>

**2.1. Partial Ionization of Sulfuric Acid.** Regarding the sulfuric acid  $pK_a$  values relevant to the first and second dissociation equilibria ( $pK_{a1} = -3$ ,  $pK_{a2} = 1.99$ ), it seems reasonable to consider that H<sub>2</sub>SO<sub>4</sub> completely ionizes into HSO<sub>4</sub><sup>-</sup>, the latter itself participating in equilibrium r10



$$K_{a2} = \frac{[H^+][SO_4^{2-}]}{[HSO_4^-]} = 0.01023 \quad (5)$$

It is worth underlining that eq 5 is only valid at a small ionic strength, where the ideal behavior of the solution is well verified. In the case of a great ionic strength, the ideal behavior of a solution has to be challenged and a particular attention should be paid to the activity coefficients. Let us now consider the influence of the activity coefficient on the second ionization constant of sulfuric acid. Eq 5 is then transformed into the following expression:

$$K_{a2} = 0.01023 = \frac{\gamma_{H^+} \gamma_{SO_4^{2-}} [H^+][SO_4^{2-}]}{\gamma_{HSO_4^-} [HSO_4^-]} \quad (6)$$

As classically, this allows us to determine the other pseudo-constant  $K'_{a2}$  as follows

$$\frac{[H^+][SO_4^{2-}]}{[HSO_4^-]} = \frac{0.01023}{\frac{\gamma_{H^+} \gamma_{SO_4^{2-}}}{\gamma_{HSO_4^-}}} = K'_{a2} \quad (7)$$

We follow three different ways to calculate the activity coefficients. Two of them are based on the Debye–Hückel theories.<sup>40</sup>

First of all, let us start with the classical Debye–Hückel relation, which is widely accepted at a low ionic strength ( $\mu < 0.1 \text{ M}$ ). It reads

$$\log_{10} \gamma_j = -0.5115 z_j^2 \sqrt{\mu} \text{ then } \log_{10} \frac{(\gamma_{H^+} + \gamma_{SO_4^{2-}})}{(\gamma_{HSO_4^-})} = -4 \times 0.5115 \sqrt{\mu} \quad (8)$$

and

$$\log_{10} K'_{a2} = \log_{10} 0.01023 + 2.046 \sqrt{\mu} \quad (9)$$

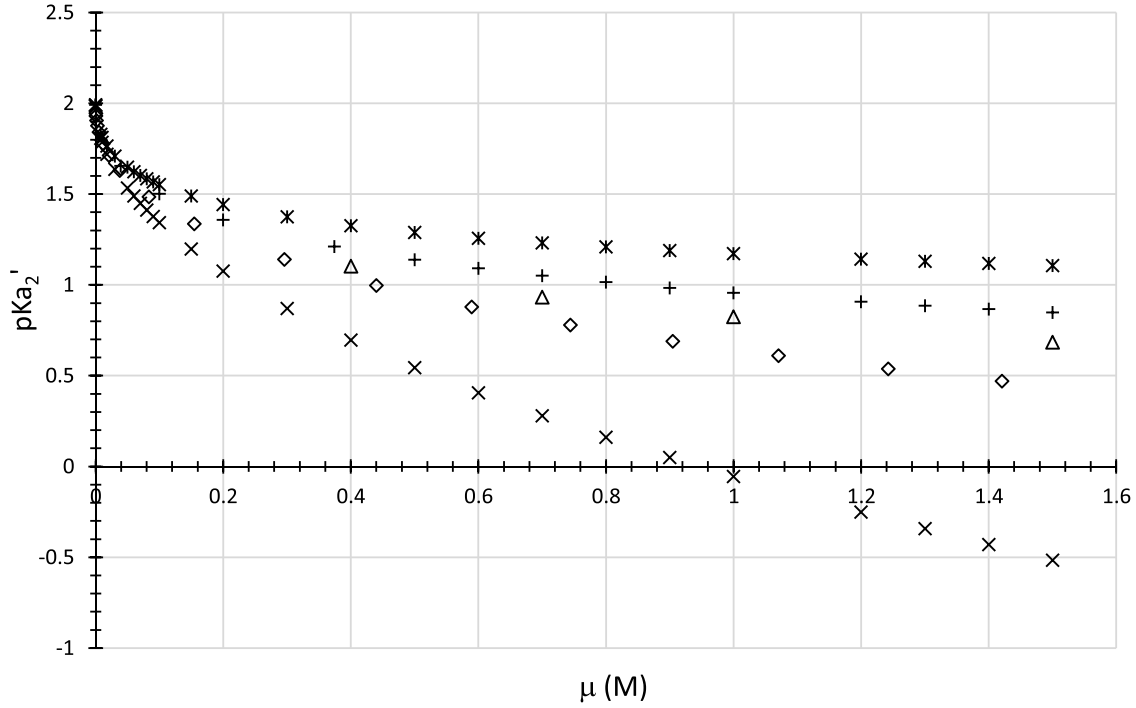

**Figure 3.** Influence of ionic strength on the second ionization constant of sulfuric acid  $K'_{a2}$ .  $\times$ : classic Debye–Hückel relation;  $\bar{x}$ : extended Debye–Hückel relation;  $\Delta$ : Baes's values for  $\frac{[\text{H}_2\text{SO}_4]}{[\text{H}_2\text{SO}_4] + [\text{Na}_2\text{SO}_4]} = 0.25$ ;  $+$ : Marshall's values;  $\diamond$ : Clegg's values.

Second, we use the extended Debye–Hückel relation, which is generally accepted for an ionic strength ranging up to 0.2 M

$$\begin{aligned} \log_{10} \gamma_j &= -\frac{0.5115 z_j^2 \sqrt{\mu}}{1 + 1.5\sqrt{\mu}} \text{ then } \log_{10} \frac{\gamma_{\text{H}} + \gamma_{\text{SO}_4^{2-}}}{\gamma_{\text{HSO}_4^-}} \\ &= -\frac{4 \times 0.5115 \sqrt{\mu}}{1 + 1.5\sqrt{\mu}} \end{aligned} \quad (10)$$

And

$$\log_{10} K'_{a2} = \log_{10} 0.01023 + \frac{2.046 \sqrt{\mu}}{1 + 1.5\sqrt{\mu}} \quad (11)$$

Finally, we estimate  $K'_{a2}$  using the data provided at 25 °C by Baes,<sup>41</sup> Marshall,<sup>42</sup> and Clegg.<sup>43</sup> Baes proposed values of the second ionization constant as a function of ionic strength, in the case of adding  $\text{Na}_2\text{SO}_4$  in acid solution. Baes's data are summarized in Table S1 available online as the Supporting Information.  $K'_{a2}$  is not only ionic-strength-dependent, but it also varies up to a factor of 2.8 depending on the composition (i.e., the different amounts of  $\text{Na}_2\text{SO}_4$ ). Ratio  $\frac{[\text{H}_2\text{SO}_4]}{[\text{H}_2\text{SO}_4] + [\text{Na}_2\text{SO}_4]}$  equals 0 or 1 in the case of a pure  $\text{Na}_2\text{SO}_4$  or  $\text{H}_2\text{SO}_4$  solution, respectively.

We found in Marshall's paper additional  $K'_{a2}$  values, which were evaluated from solubilities of calcium sulfate in aqueous sulfuric acid solution. Other  $K'_{a2}$  values are also calculated from degrees of dissociation of the  $\text{HSO}_4^-$  ion in aqueous  $\text{H}_2\text{SO}_4$  from 0 to 6.1 mL  $\text{kg}^{-1}$ , which were published by Clegg.

Considering eqs 8 and 10 and the values proposed by Baes, Marshall, and Clegg,  $\text{p}K'_{a2}$  values versus ionic strength are calculated and presented in Figure 3. It clearly demonstrates the well-accepted trend of an increase in acid dissociation constant as ionic strength increases. In other words, the higher the ionic strength, the stronger the acid. In the case of eq 10,

$\text{p}K'_{a2}$  decreases from 1.99 to 1.26 when  $\mu$  ranges from 0 to 0.6 M. As the ionic strength is smaller than 0.1 M, all  $\text{p}K'_{a2}$  values obtained by either eq 8 or 10 or proposed by Baes, Marshall, and Clegg are of the same order of magnitude. It confirms the fact that at a small ionic strength, both classic and extended Debye–Hückel relations are accurate independently of the solution composition (pure sulfuric acid or sulfuric acid-sodium sulfate solutions). Quite the opposite, at a higher ionic strength, we can observe a significant growing discrepancy between the  $\text{p}K'_{a2}$  values obtained with both Debye–Hückel relations. The  $\text{p}K'_{a2}$  values proposed by Baes, Marshall, and Clegg are intermediate and a bit smaller than the values calculated with the extended Debye–Hückel relation. Baes values are framed by the Clegg and Marshall values, the latter being somewhat smaller than the values calculated with the extended Debye–Hückel relation. Baes and Marshall data are both in relatively good agreement.

Regarding the  $K'_{a2}$  values thus obtained, the ionic strength has a considerable influence on the dissociation of  $\text{HSO}_4^-$  into  $\text{SO}_4^{2-}$ . At a high ionic strength, the different methods involved for its estimation seem rather divergent.

**2.2. Data Treatment.** Our previous experimental results<sup>16</sup> have been revisited in the light of the newly calculated equilibrium constant  $K'_{a2}$ . A mass balance can be expressed yielding an equation system for the respective extents  $X_1$ ,  $X_2$ , and  $X_a$  of reactions r1, r2, and r10

$$[\text{I}^-] = [\text{I}^-]_0 - 5C'_0X_1 - C'_0X_2 \quad (12)$$

$$[\text{H}^+] = [\text{H}^+]_0 - 6C'_0X_1 + C'_0X_a \quad (13)$$

$$[\text{IO}_3^-] = [\text{IO}_3^-]_0 - C'_0X_1 \quad (14)$$

$$[\text{I}_2] = 3C'_0X_1 - C'_0X_2 \quad (15)$$

$$[\text{I}_3^-] = C'_0X_2 \quad (16)$$

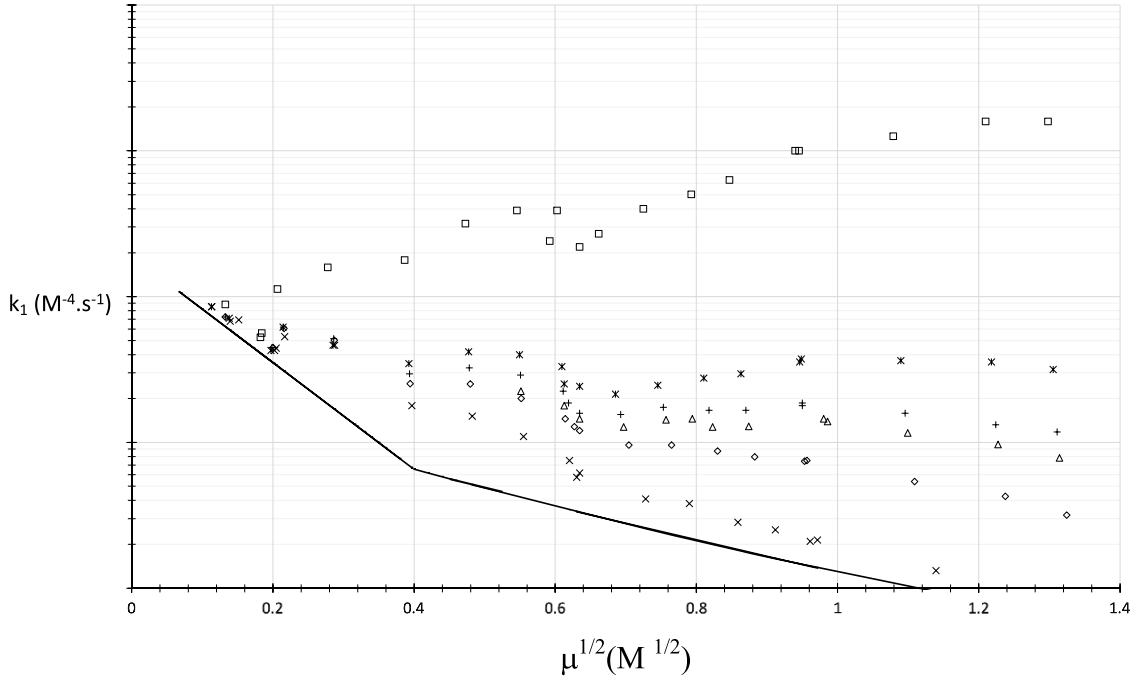

**Figure 4.** Evolution of the kinetic constant  $k_1$  vs square root of the ionic strength in the case of using sulfuric acid;  $-$ : Guichardon's study;<sup>16</sup>  $\square$ :  $K'_{a2} = 0.01023$ ;  $\times$ : Classic Debye–Hückel relation;  $\ast$ : extended Debye–Hückel relation;  $\triangle$ : Baes values;  $+$ : Marshall's values;  $\diamond$ : Clegg's values.

$$[\text{HSO}_4^-] = [\text{HSO}_4^-]_0 - C'_0 X_a \quad (17)$$

$$[\text{SO}_4^{2-}] = [\text{SO}_4^{2-}]_0 + C'_0 X_a \quad (18)$$

where

$$C'_0 = [\text{I}^-]_0 + [\text{H}^+]_0 + [\text{IO}_3^-]_0 + [\text{HSO}_4^-]_0 + [\text{SO}_4^{2-}]_0$$

The rate law may be linked to the  $\text{IO}_3^-$  concentration through the differential equation below:

$$r_1 = \frac{-d[\text{IO}_3^-]}{dt} = k_1 [\text{I}^-]^2 [\text{H}^+]^2 [\text{IO}_3^-] \quad (19)$$

Introducing the extents of reaction in eq 20, the differential equation can be written as

$$\frac{d(X_1)}{dt} = k_1 C_0'^4 (y_{\text{I}^-} - 5X_1 - X_2)^2 (y_{\text{H}^+} - 6X_1 + X_a)^2 (y_{\text{IO}_3^-} - X_1) \quad (20)$$

where

$$y_{\text{I}^-} = \frac{[\text{I}^-]_0}{C'_0} y_{\text{H}^+} = \frac{[\text{H}^+]_0}{C'_0} y_{\text{IO}_3^-} = \frac{[\text{IO}_3^-]_0}{C'_0}$$

where  $X_2$  is calculated with the equation deduced from equilibrium 2, which may be written as the quadratic following expression:

$$X_2^2 + \left( 2X_1 - y_{\text{I}^-} - \frac{1}{K_2 C'_0} \right) X_2 - 15X_1^2 + 3y_{\text{I}^-} X_1 = 0 \quad (21)$$

where  $X_a$  is also obtained from the equilibrium eq 5, written as the quadratic expression

$$\begin{aligned} X_a^2 + \left( y_{\text{H}^+} + y_{\text{SO}_4^{2-}} - 6X_1 + \frac{K'_{a2}}{C'_0} \right) X_a \\ + (y_{\text{H}^+} - 6X_1) y_{\text{SO}_4^{2-}} - K_{a2} y_{\text{HSO}_4^-} \\ = 0 \end{aligned} \quad (22)$$

where

$$y_{\text{HSO}_4^-} = \frac{[\text{HSO}_4^-]_0}{C'_0}$$

For a given value of  $k_1$ , the extents of reaction  $X_{1,c}(t)$ ,  $X_{2,c}(t)$ , and  $X_{a,c}(t)$  are calculated by numerically integrating eq 20 with MATLAB (ODE45). Note that eq 20 is coupled with eqs 21 and 22. An optimization method was then applied via MATLAB to minimize the objective function  $F$  defined as

$$F = \sum_{t_0}^{t_f} (X_{1,c}(t) - X_{1,\text{exp}}(t))^2 \quad (23)$$

**2.3. Results.** Including the partial ionization of sulfuric acid and ionic strength contribution, the constant rate  $k_1$  has been calculated in accordance with eq 2 from the experimental triiodide concentration versus time curve extracted from Guichardon's study.<sup>16</sup>

Figure 4 shows the evolution of the newly calculated kinetic constants versus ionic strength (including different modes of  $K'_{a2}$  estimation), which are compared with the previously published rate law.

As expected, the  $K'_{a2}$  value has a considerable effect on the determined constant rate  $k_1$ . In all cases, the newly determined  $k_1$  values are always higher than those previously proposed by Guichardon.<sup>16</sup> This is mainly due to the impact of  $K'_{a2}$  on the calculated  $\text{H}^+$  concentration in the solution. As illustrated in Figure 4, considering sulfuric acid as a weak acid results in a decrease in  $\text{H}^+$  concentration in comparison with the case of a

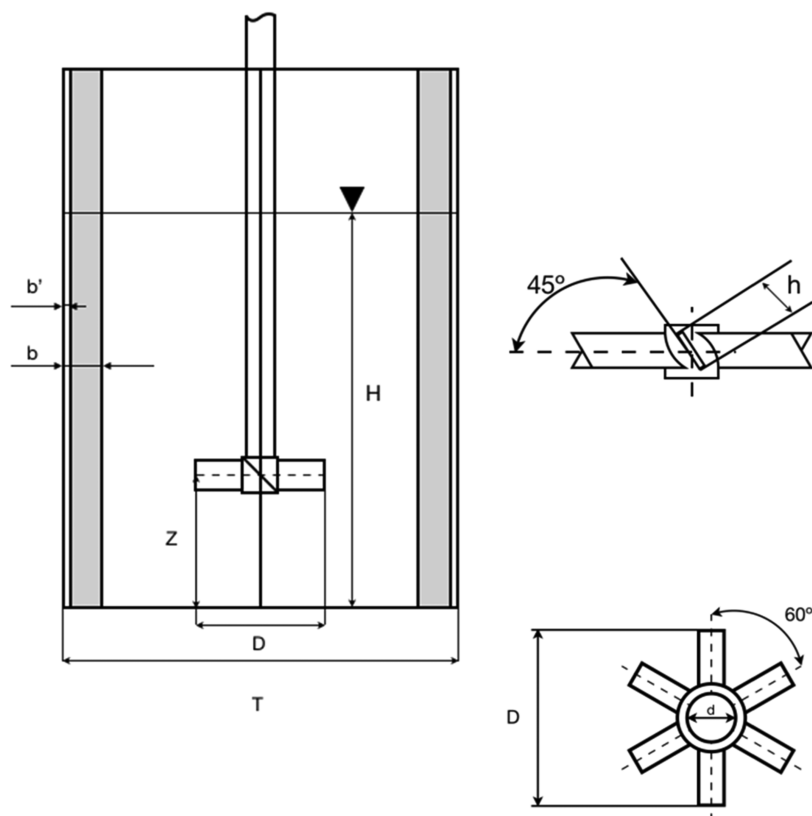

**Figure 5.** Experimental setup:  $T = H = 0.110$  m,  $D = T/3$ ,  $d = 0.1$  m,  $h = D/5$ ,  $b = H/10$ ,  $b' = H/50$ .

strong acid. For instance, when considering  $K'_{a2}$  as a constant ( $K'_{a2} = 0.01023$ ) with  $[\text{H}_2\text{SO}_4]_0 = 10^{-2}$  M,  $\text{H}^+$  concentration equals  $1.41 \times 10^{-2}$  M instead of  $2 \times 10^{-2}$  in the case of fully ionized sulfuric acid. This effect on  $k_1$  is all the more marked as  $r_1$  varies as a function of the square of the  $\text{H}^+$  concentration. It is worth underlining that considering  $K'_{a2}$  as independent of the ionic strength is not convenient when ionic strength is increased. If we remove this case, the former tendency describing a decrease of reaction rate with increasing ionic strength seems to be confirmed. The remarkable finding is the increasing gap observed between all values when increasing the ionic strength. Due to an inaccurate estimation of  $K'_{a2}$  versus ionic strength, it is really difficult to establish a reliable kinetic law when using sulfuric acid. This point strongly supports the idea that it is essential to carry out new experiments using a strong acid to get rid of the  $K'_{a2}$  estimation, which is deeply problematic at a high ionic strength. In this context, we decided to reinvestigate the Dushman reaction rate with perchloric acid instead of sulfuric acid. Ionic strength will be controlled by adding  $\text{NaClO}_4$ . This study is detailed in the next paragraph.

### 3. KINETIC INVESTIGATION WITH THE USE OF PERCHLORIC ACID

**3.1. Experimental Setup.** Diluted solutions are prepared from strong solutions obtained with concentrated perchloric acid and dried powders of KI and  $\text{KIO}_3$ . The ionic strength control is ensured by adding  $\text{NaClO}_4$  up to 0.65 M. All solutions are prepared with distilled water. Concentrations range as follows

$$1.6 \times 10^{-3} \text{ M} \leq [\text{I}^-]_0 \leq 1.6 \times 10^{-2} \text{ M}$$

$$1.2 \times 10^{-4} \text{ M} \leq [\text{H}^+]_0 \leq 1.57 \times 10^{-2} \text{ M}$$

$$4 \times 10^{-5} \text{ M} \leq [\text{IO}_3^-]_0 \leq 2.1 \times 10^{-4} \text{ M}$$

$$0 \text{ M} \leq [\text{NaClO}_4]_0 \leq 2 \text{ M}$$

In the case of a strong acid as perchloric acid, ionic strength has no influence on the acid dissociation and  $\gamma_{\text{H}^+}$  remains constant.<sup>44</sup>

Kinetic experiments were directly carried out in a 1 L standard stirred tank reactor equipped with four baffles and a jacket ensuring temperature control. The stirrer is a six-inclined-blade turbine in a standard configuration (Figure 5).

At a fixed stirring speed  $N = 1200$  rpm, the experimental procedure consists in adding 0.1 L of a solution containing the reagent in stoichiometric defect to the bulk (0.9 L), which contains the other premixed reagents. The  $\text{I}_3^-$  concentration is monitored on-line as a function of time with an optical spectrophotometric probe (reference: FDP 7UV200-2-5-HT 120-3/37) from Avantes offering a 0.01 m optical path length. In relation to the maximum light absorption located at 353 nm, the Beer–Lambert law, verified beforehand, is applied to calculate the  $\text{I}_3^-$  concentration. The absorbance varies linearly versus  $\text{I}_3^-$  concentration up to  $5 \times 10^{-5}$  M. The molar extinction coefficient  $\epsilon$  of  $\text{I}_3^-$  at 353 nm is then determined to be  $2465 \text{ m}^2 \text{ mol}^{-1}$ .

**3.2. Data Treatment.** **3.2.1. Rough Experimental Data Treatment.** According to the Beer–Lambert law, the  $\text{I}_3^-$  concentration is calculated from the experimentally measured light absorption.  $X_2$ , the extent of reaction  $r_2$ , is then easily deduced by

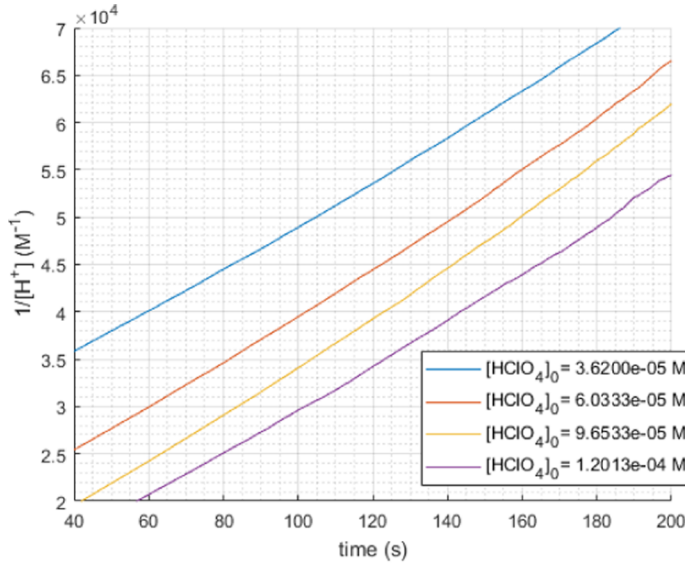

(a)

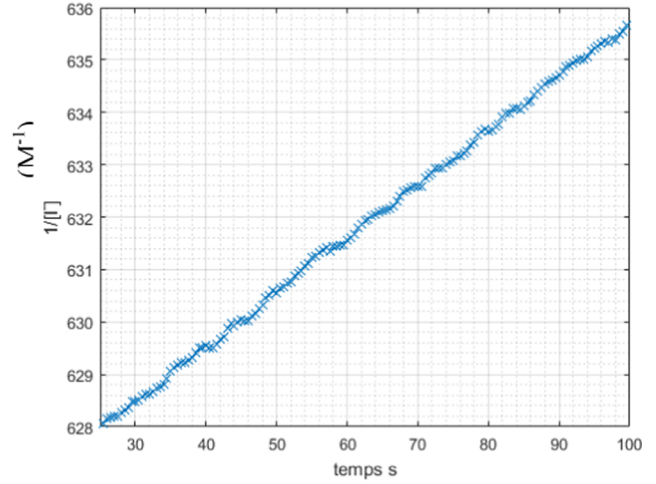

(b)

**Figure 6.** Evolution of  $\frac{1}{[Z]}$  versus time: (a)  $Z = \text{H}^+$ ,  $[\text{I}^-]_0 = 1.6 \times 10^{-2} \text{ M}$ ;  $3.6 \times 10^{-5} < [\text{H}^+]_0 < 12 \times 10^{-5} \text{ M}$ ;  $[\text{IO}_3^-]_0 = 2.1 \times 10^{-4} \text{ M}$ ; (b)  $Z = \text{I}^-$ ,  $[\text{I}^-]_0 = 1.6 \times 10^{-3} \text{ M}$ ;  $[\text{H}^+]_0 = 1.2 \times 10^{-4} \text{ M}$ ;  $[\text{IO}_3^-]_0 = 2 \times 10^{-4} \text{ M}$ .

$$[\text{I}_3^-] = C_0 X_2 \quad (24)$$

where

$$C_0 = [\text{I}^-]_0 + [\text{H}^+]_0 + [\text{IO}_3^-]_0 \quad (25)$$

Experimental extents of reaction  $X_1$  and  $X_2$  are obtained thanks to eq 24 and 21.

### 3.2.2. Optimization Method for Kinetic Determination.

The same data treatment as the one developed in the previous paragraph is used. In that case, the mass balance can be expressed yielding a system of equations for the respective extents  $X_1$  and  $X_2$  of reactions r1 and r2

$$[\text{I}^-] = [\text{I}^-]_0 - 5C_0 X_1 - C_0 X_2 \quad (26)$$

$$[\text{H}^+] = [\text{H}^+]_0 - 6C_0 X_1 \quad (27)$$

$$[\text{IO}_3^-] = [\text{IO}_3^-]_0 - C_0 X_1 \quad (28)$$

$$[\text{I}_2] = 3C_0 X_1 - C_0 X_2 \quad (29)$$

$$[\text{I}_3^-] = C_0 X_2 \quad (30)$$

After checking (as explained later in Section 3.3.2) that  $\text{H}^+$ ,  $\text{I}^-$ , and  $\text{IO}_3^-$  dependences on the reaction rate remain two, two, and one, respectively, eq 20 is transformed into eq 32

$$\frac{d(X_1)}{dt} = k_1 C_0^4 (y_{\text{I}^-} - 5X_1 - X_2)^2 (y_{\text{H}^+} - 6X_1)^2 (y_{\text{IO}_3^-} - X_1) \quad (31)$$

where

$$y_{\text{I}^-} = \frac{[\text{I}^-]_0}{C_0} y_{\text{H}^+} = \frac{[\text{H}^+]_0}{C_0} y_{\text{IO}_3^-} = \frac{[\text{IO}_3^-]_0}{C_0}$$

As previously detailed, for a given value of  $k_1$ , the extents of reaction  $X_{1c}(t)$ ,  $X_{2c}(t)$  are calculated by numerically integrating eq 31 with MATLAB (ODE45). Note that eq 31 is coupled

with eq 21, where  $C_0'$  is replaced by  $C_0$ . The same optimization method is applied aiming to minimize the objective function  $F$  [i.e., eq 23].

### 3.3. Results. 3.3.1. Mixing and Kinetic Measurements.

First of all, a rapid check of hydrodynamics and mixing efficiency offered by our tank reactor is carried out. Indeed, it is of the utmost importance that the macromixing is reached quickly and that the mixing effects do not affect the quality of the kinetic results. At  $N = 600 \text{ rpm}$ , 0.1 L of a blue-colored water solution is fed into the vessel containing 0.9 L of water. The distinctive absorbance of the blue food dye is monitored at 635 nm as a function of time. The experimentally determined macromixing time is found to be less than 4 s. Compared with the average consumption time of reagents, as observed during the kinetic investigation (greater than 700 s), we can reasonably consider that the iodine yield obtained during the macromixing step is negligible.

**3.3.2. Partial Reaction Orders.** Despite the current (low) uncertainty on the reaction orders, we determine them according to  $\text{H}^+$  and  $\text{IO}_3^-$  under our new conditions. The dependence of reagent  $Z$  on the rate law is investigated by varying the concentration of  $Z$ , while the other reagent concentrations are chosen high enough to be considered invariable during the reaction.

In the case of  $Z = \text{H}^+$ , let us remind the main equation:

$$r_1 = -\frac{1}{6} \frac{d[\text{H}^+]}{dt} = k_1 (\mu) [\text{H}^+]^p [\text{I}^-]^n [\text{IO}_3^-]^m = A [\text{H}^+]^p \quad (32)$$

where  $A = k_1 [\text{IO}_3^-]_0^m [\text{I}^-]_0^n = \text{constant}$   
Rewritten as

$$\frac{d[\text{H}^+]}{[\text{H}^+]^p} = -6A dt \quad (33)$$

For the expected  $p$  value ( $p = 2$ ), the integration of eq 33 leads to a linear variation of  $\frac{1}{[H^+]}$  versus time as:

$$\frac{1}{[H^+]} = \frac{1}{[H^+]_0} + 6At \quad (34)$$

The study of iodide dependence is a little more complicated because of the simultaneous involvement of iodide in reactions r1 and r2. The following equations that govern the iodide and iodine concentrations can be written

$$-\frac{d[I^-]}{dt} = 5r_1 + r_2 = 5A''[I^-]^n + k_2[I^-][I_2] - k_{-2}[I_3^-] \quad (35)$$

$$\frac{d[I_2]}{dt} = 3r_1 - r_2 = 3A''[I^-]^n - k_2[I^-][I_2] + k_{-2}[I_3^-] \quad (36)$$

We can then deduce from the sum of eqs 35 and 36

$$-\frac{d([I^-] - [I_2])}{dt} = 8A''[I^-]^n \quad (37)$$

For  $n = 2$ , eq 37 can easily be integrated in the same form as eq 34 if the formed iodine concentration can be neglected in relation to the iodide concentration. We can then obtain

$$\frac{1}{[I^-]} = \frac{1}{[I^-]_0} + 8A''t \quad (38)$$

Figure 6 presents the experimentally measured evolution of  $\frac{1}{[H^+]}$  versus time for different initial  $H^+$  concentrations, and the experimentally measured evolution of  $\frac{1}{[I^-]}$  versus time in the case of a low iodine concentration. At  $t = 100$  s (Figure 6b), the iodide and iodine concentrations are  $1.57 \times 10^{-3}$  and  $5.55 \times 10^{-6}$  M, respectively. It seems then realistic to consider the formed iodine concentration as negligible, in comparison with the iodide concentration (higher than  $10^{-3}$  M).

In all cases, a remarkable linearity is obtained, attesting to the second-order dependence of  $H^+$  and  $I^-$  in the rate law.

In the case of  $Z = IO_3^-$ , we expect to find a one-order rate law. Equations 32–34 turn into

$$r_1 = -\frac{d[IO_3^-]}{dt} = A'[IO_3^-]^m \quad (39)$$

where we suppose  $A' = [H^+]_0^p [I^-]_0^n = \text{constant}$

$$\frac{d[IO_3^-]}{[IO_3^-]} = -A'dt \quad (40)$$

$$-\ln[IO_3^-] = -\ln[IO_3^-]_0 + A't \quad (41)$$

As illustrated in Figure 7, the representation of  $-\ln[IO_3^-]$  versus time shows a perfect linear variation corroborating the single-order dependence of iodate ion in the rate law.

All of the results confirm the fifth-order rate law, where the  $H^+$ ,  $I^-$ , and  $IO_3^-$  dependences are, respectively, 2, 2, and 1, under any condition.

**3.3.3. Constant Rate.** As detailed in Section 3.2.2, the constant rate  $k_1$  is estimated via an optimization method minimizing the gap between  $X_{\text{exp}}$  and  $X_{\text{cal}}$  in the experimental and calculated reaction extents of reaction r1, respectively. In Figure 8, the calculated kinetic constant  $k_1$  is plotted versus ionic strength ranging from 0 to 2 M.

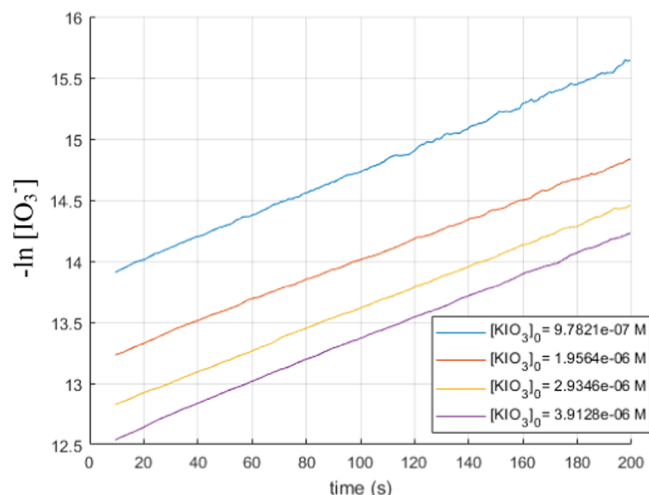

Figure 7. Evolution of  $-\log_{10}[IO_3^-]$  versus time:  $[I^-]_0 = 6.4 \times 10^{-3}$  M;  $[H^+]_0 = 4.8 \times 10^{-4}$  M;  $9.8 \times 10^{-7} < [IO_3^-]_0 < 3.9 \times 10^{-6}$  M.

At small ionic strengths ( $\mu \leq 0.4$  M), the experimental results are consistent with the Debye–Hückel theory. An increase of ionic strength causes a decrease of the rate constant, which is fitted by the following linear relation

$$\log_{10} k_1 = 8.884 \pm 0.009 - (0.921 \pm 0.0211)\sqrt{\mu} \quad (42)$$

At a higher ionic strength,  $k_1$  remains almost constant around the following value

$$k_1 = (1.96 \pm 0.09) \times 10^8 \text{ M}^{-4} \cdot \text{s}^{-1} \quad (43)$$

## 4. DISCUSSION

Let us now compare the results obtained with sulfuric acid to those carried out with perchloric acid. All of the rate constants obtained are presented versus ionic strength in Figure 9.

All of the results are consistent at a small ionic strength ( $\mu \leq 0.1$  M); the acid choice just has a small effect on the different kinetic constants found experimentally, all of them being of the same order of magnitude. On the contrary, at a higher ionic strength range (say,  $\mu \geq 0.2$  M), the results obtained with sulfuric acid are very different according to the manner of calculating  $K'_{a2}$ . The kinetic constants obtained with the use of the classical Debye–Hückel relation are profoundly underestimated, confirming their unavailability in this range of ionic strength. Better agreement is observed with Debye–Hückel's extended relationship and Baes' data, which offer slight over- and underestimates, respectively. The best accordance is obtained with Marshall's values, which provide very close data for ionic strength up to 1 M. It is worth pointing out that the nonideal behavior of sulfuric acid is still not precisely described to date.

In Figure 10, the values of  $k_1$ , as now determined in accordance with eqs 42 and 43, are compared with the most recent fifth-order rate laws from the literature.<sup>18–20</sup> Not all results are the same, but the agreement is relatively good for small ionic strength.

First, it can be noted that Arian's results overestimate the rate constant  $k_1$ , which does not vary monotonically with ionic strength: a decrease of  $k_1$  is found with ionic strength up to 0.6 M, while beyond this value  $k_1$  increases. A good agreement between Schmitz's data, Manzano Martinez's data, and our results is obtained. It is unfortunate that Schmitz did not

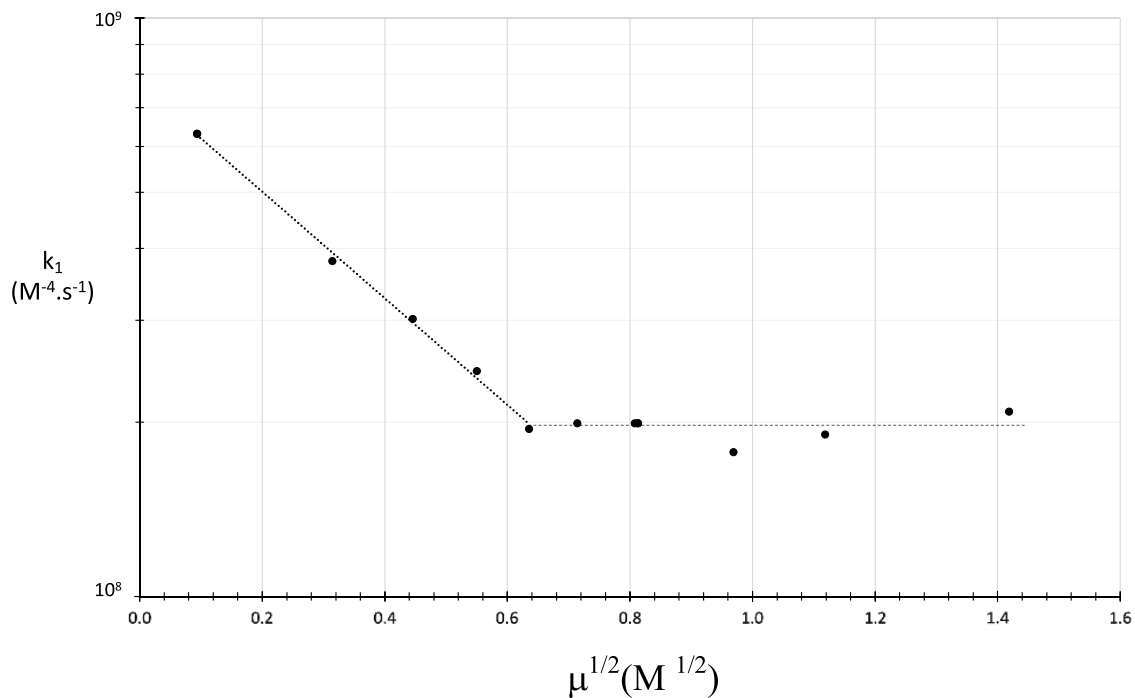

Figure 8. Dependence of kinetic constant  $k_1$  on ionic strength.

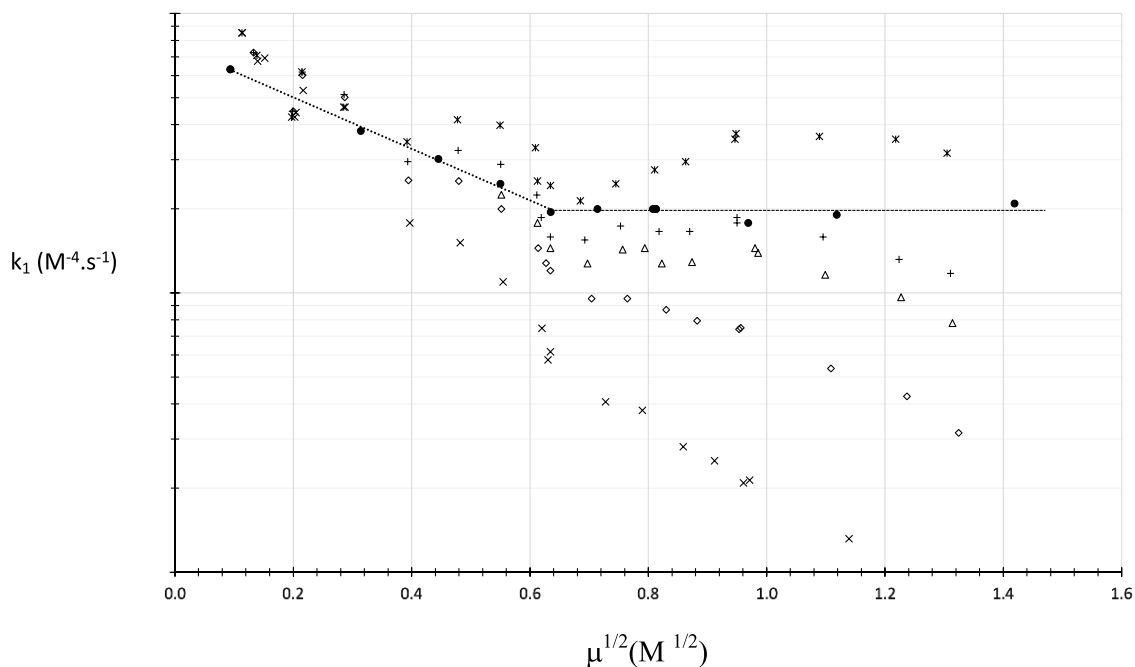
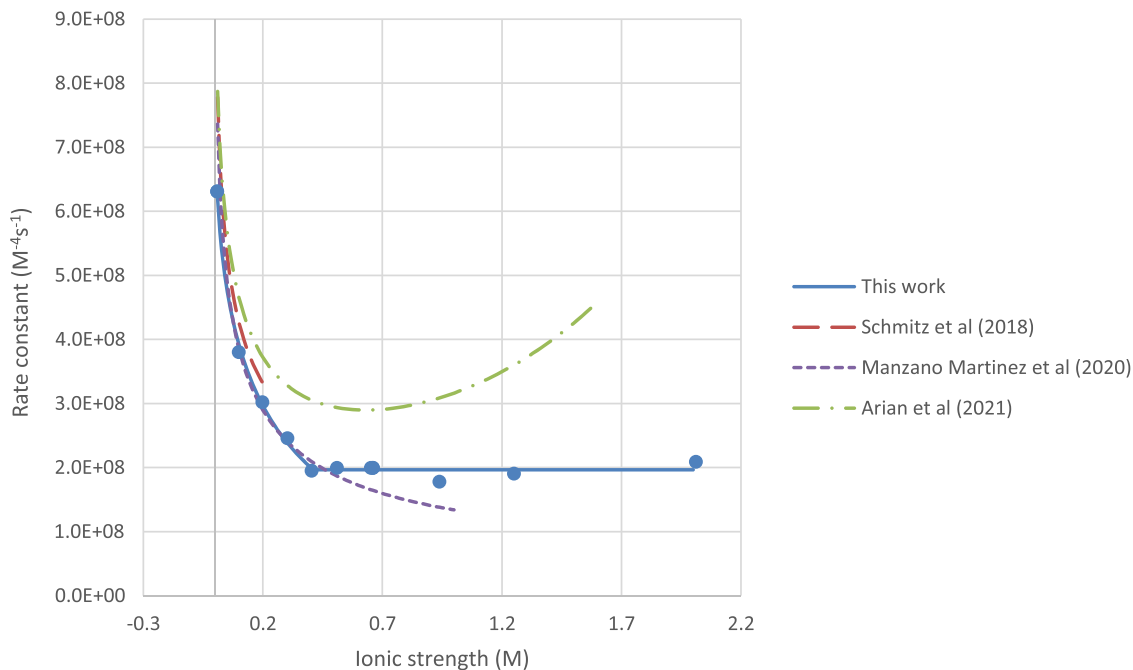

Figure 9. Evolution of the kinetic constant  $k_1$  as a function of ionic strength, considering the effect of the ionic strength on the activity coefficients and sulfuric acid dissociation. ●:  $\text{HClO}_4$ ; x:  $\text{H}_2\text{SO}_4$ , classic Debye–Hückel relation;  $\Delta$ :  $\text{H}_2\text{SO}_4$ , Baes values;  $\boxtimes$ :  $\text{H}_2\text{SO}_4$ , extended Debye–Hückel relation; +: Marshall's values;  $\diamond$ : Clegg's values.

provide results for ionic strength higher than 0.2 M. It can be also seen that our results overlap exactly with the results of Manzano Martinez. The agreement is perfect for ionic strength up to 0.5 M, and the relative error between the  $k_1$  values is about 42% at  $\mu = 1$  M. It seems very promising compared to the factor of 10 found between the various other published rate laws as shown in Section 1. This result may be a validation of both studies.

## 5. CONCLUSIONS

First of all, this study confirms the fifth-order rate law, which has widely been reported in published works. Considering the whole complexity of the kinetics, this paper presents coherent results in a range of parameters, which is relevant to the micromixing studies. More precisely, the kinetic results that we have obtained are reliable for any concentrations. Note that the studied  $\text{I}^-$  concentration range covers the usual operating conditions used in micromixing test, while the  $\text{H}^+$  and  $\text{IO}_3^-$



**Figure 10.** Comparison of our results with the most recent data.

concentrations upper bound are still a little low in the context of the Villiermaux–Dushman test.

This weak point of our experimental kinetics validation should not be of importance because the second order in the partial rate law for  $\text{H}^+$  and the first order for  $\text{IO}_3^-$  have never given rise to serious controversy. Clearly, they are, respectively, 2 and 1, under any condition.

The experimentally determined rate constant is written as follows

fitted by the following linear relation

$$\begin{cases} \log_{10} k_1 = 8.884 \pm 0.009 & \mu \leq 0.4 \text{ M} \\ \quad - (0.921 \pm 0.0211) \sqrt{\mu} \\ k_1 = (1.96 \pm 0.09) \times 10^8 \text{ M}^{-4} \cdot \text{s}^{-1} & \mu \geq 0.4 \text{ M} \end{cases} \quad (44)$$

The results obtained with the use of sulfuric and perchloric acids are in relatively good agreement, as long as the ionic strength is smaller than 0.1 M. In the case of a higher ionic strength, the estimation of an accurate  $K'_{a2}$  value as a function of the solution composition remains a difficult task. Concerning the debate about the kind of reagents used, it is important to reject chloride acid and nitrite acid. When using sulfuric acid, particular attention has to be paid to the actual dissociation equilibria and to the behavior of nonideal solutions requiring the involvement of activity coefficients. These last two points have a considerable impact on the concentration  $[\text{H}^+]$  in solution, which implies a major effect on the accuracy of the calculated rate constant. It is then preferable to choose perchloric acid rather than sulfuric acid, which is frequently used. Precise kinetic data on Dushman's reaction are now available. With these results, the consolidation of the Villiermaux–Dushman test merits a more in-depth sensitivity study of the kinetic data on the determination of the micromixing time by modeling from the experimental results obtained with perchloric acid, especially for ionic strength higher than 0.5 M. This is the scope of a forthcoming paper.

## ■ REFERENCES

- (1) Fournier, M. C. Caractérisation de l'efficacité de micromélange par une nouvelle réaction chimique test. PhD. Thesis, INPL Nancy, 1994.
- (2) Fournier, M. C.; Falk, L.; Villermaux, J. A new parallel competing reaction system for assessing micromixing efficiency. Experimental approach. *Chem. Eng. Sci.* **1996**, *51*, 5053–5064.
- (3) Guichardon, P. Caractérisation chimique du micromélange par la réaction iodure-iodate. PhD. Thesis, INPL Nancy, 1996.
- (4) Guichardon, P.; Falk, L. Characterisation of micromixing efficiency by the iodide iodate reaction system. Part I: experimental procedure. *Chem. Eng. Sci.* **2000**, *55*, 4233–4243.
- (5) Dushman, S. The rate of the reaction between iodic and hydriodic acids. *J. Phys. Chem. A* **1904**, *8*, 453–482.
- (6) Cantrel, L. Caractérisation de l'acide hypoiodéux, réactions d'oxydation de l'iode. PhD. Thesis, Aix Marseille 3, 1997.
- (7) Abel, E.; Hilferding, K. Revision der Kinetik der HI<sub>3</sub>-HI Reaktion. II. *Z. Phys. Chem.* **1928**, *A135*, 186–194.
- (8) Furuichi, R.; Matsuzaki, I.; Simic, R.; Liebhafsky, H. A. Rate of the Dushman reaction at low iodide concentrations. Experimental method and temperature coefficient. *Inorg. Chem.* **1972**, *11*, 952–955.
- (9) Furuichi, R.; Liebhafsky, H. A. Rate of the Dushman reaction in iodic acid at low iodide concentration. Complexity of iodic acid. *Bull. Chem. Soc. Jpn.* **1975**, *48*, 745–750.
- (10) Sand, J.; Kaestle, K. Dichromat and Chromat. *Z. Anorg. Chem.* **1907**, *52*, 101–123.
- (11) Indelli, A. Salt effects in the reactions between iodate and iodide. *J. Phys. Chem. B* **1961**, *65*, 240–242.
- (12) Haberland, D.; Landsberg, R. Zur Anwendung der rotierenden Scheibenelektrode beim Studium nachgelagerter quasiautokatalytischer Reaktionen zweiter Ordnung. *Ber. Bunsengesellschaft Phys. Chem.* **1967**, *71*, 219–221.
- (13) Hasty, R. A. Reduction of iodate by hydrazine: application of the iodide ion selective electrode to the uncatalyzed reaction. *Mikrochim. Acta* **1973**, 925–933.
- (14) Nikolelis, D. P.; Karayannis, M. I.; Hadjhoannou, T. P. Kinetic study of the iodate-iodide and chlorate-iodide reactions in acidic solutions and a method for the microdetermination of bromide. *Anal. Chim. Acta* **1977**, *94*, 415–420.
- (15) Palmer, D. A.; Lyons, L. J. *Kinetics of Iodine Hydrolysis in Unbuffered Solutions*, Proceedings of the second CSNI workshop on iodine chemistry in reactor safety, Vikis, A. C., Eds.; Toronto, Canada, 1988.
- (16) Guichardon, P.; Falk, L.; Villermaux, J. Characterisation of micromixing efficiency by the iodide-iodate reaction system. Part II: kinetic study. *Chem. Eng. Sci.* **2000**, *55*, 4245–4253.
- (17) Xie, Y.; MacDonald, M. R.; Margerum, D. W. Mechanism of the reaction between iodate and iodide ions in acid solutions (Dushman reaction). *Inorg. Chem.* **1999**, *38*, 3938–3940.
- (18) Schmitz, G.; Bourceanu, G.; Ungureanu, I. Effects of Ce(III) and Mn(II) on the Dushman reaction and simulations of the Briggs-Rauscher reaction. *React. Kinet., Mech. Catal.* **2018**, *123*, 81–92.
- (19) Manzano Martínez, A. N.; Sander Haase, A.; Assirelli, M.; Van der Schaaf, J. Alternative Kinetic Model of Iodide-Iodate Reaction for Its Use in Micromixing Investigations. *Ind. Eng. Chem. Res.* **2020**, *59*, 21359–21370.
- (20) Arian, E.; Pauer, W. Contributions to the kinetics of the iodide-iodate test reaction for micromixing time calculation with extended incorporation models. *Chem. Eng. Sci.* **2021**, *237*, No. 116549.
- (21) Wronska, M.; Banas, B. Kinetic investigations on the oxidation of iodide with iodate. *Bulletin de l'Académie Polonaise de Sciences, Série des sciences chimiques* **1965**, *13*, 5.
- (22) Beran, P.; Bruckenstein, S. A rotating disk electrode study of the catalytic wave produced by the reduction of iodine in the presence of iodate. *J. Phys. Chem. C* **1968**, 3630–3635.
- (23) Abel, E.; Staedler, F. Revision der Kinetik der HIO<sub>3</sub>-HI Reaktion. *Z. Phys. Chem.* **1926**, *122*, 49–79.
- (24) Myers, O. E.; Kennedy, J. W. The kinetics of the iodine-iodate isotopic exchange reaction. *J. Am. Chem. Soc.* **1950**, *72*, 897–906.
- (25) Barton, A. F.; Wright, G. A. Kinetics of iodate-iodide reaction: Catalysis by carboxylate and phosphate ions. *J. Chem. Soc. A* **1968**, *12*, 2096–2103.
- (26) Barton, A. F.; Cheong, H. N.; Smidt, R. E. Kinetics of the bromate-iodide and iodate-iodide reactions by pH-Stat Techniques. *J. Chem. Soc., Faraday Trans.* **1975**, *1*, 568–574.
- (27) Schildcrout, S. M.; Fortuno, F. A. A spectrometric study of the rate of the aqueous iodate-iodide reaction. *J. Phys. Chem. D* **1975**, *79*, 31–34.
- (28) Schmitz, G. Kinetics and mechanism of the iodate-iodide reaction and other related reactions. *Phys. Chem. Chem. Phys.* **1999**, *1*, 1909–1914.
- (29) Schmitz, G. Kinetics of the Dushman reaction at low I- concentrations. *Phys. Chem. Chem. Phys.* **2000**, *2*, 4041–4044.
- (30) Agreda B, J. A.; et al. Kinetic evidence for accumulation of stoichiometrically significant amounts of H<sub>2</sub>I<sub>2</sub>O<sub>3</sub> during the reaction of I<sup>-</sup> with IO<sub>3</sub><sup>-</sup>. *J. Phys. Chem. A* **2000**, *104*, 5269–5274.
- (31) Valkai, L.; Horvath, A. K. Compatible mechanism for a simultaneous description of the Roebuck, Dushman and iodate-arsenous acid reactions in an acidic medium. *Inorg. Chem.* **2016**, *55*, 1595–1603.
- (32) Kölbl, A.; Desplantes, V.; Grundemann, L.; Scholl, S. Kinetic investigation of the Dushman reaction at concentrations relevant to mixing studies in stirred tank reactors. *Chem. Eng. Sci.* **2013**, *93*, 47–54.
- (33) Kölbl, A.; Kraut, M.; Dittmeyer, R. Kinetic investigation of the Dushman reaction at concentrations relevant to mixing studies in microstructured cyclone type mixers. *Chem. Eng. Sci.* **2013**, *101*, 454–460.
- (34) Wenzel, D.; Assirelli, M.; Rossen, H.; Lopattchenko, M.; Gorak, A. On the reactant concentration and the reaction kinetics in the villermaux Dushman protocol. *Chem. Eng. Process.* **2018**, *130*, 332–341.
- (35) Morgan, K. J. Some reactions of inorganic iodine compounds. *Hinshelwood J.* **1947**, *694*, 123–146.
- (36) Bray, W. K. An oxide of iodine I<sub>2</sub>O<sub>2</sub>. An intermediate compound. *J. Am. Chem. Soc.* **1930**, *52*, 3580–3586.
- (37) Kölbl, A.; Schmidt-Lehr, S. The iodide iodate reaction method: the choice of the acid. *Chem. Eng. Sci.* **2010**, *65*, 1897–1901.
- (38) Baqueiro, C.; Ibaseta, N.; Guichardon, P.; Falk, L. Influence of reagents choice (buffer, acid and inert salt) on triiodide production in the Villermaux-Dushman method applied to a stirred vessel. *Chem. Eng. Res. Des.* **2018**, *136*, 25–31.
- (39) Palmer, D. A.; Ramette, R. W.; Mesmer, R. E. Triiodide ions formation equilibrium and activity coefficients in aqueous solution. *J. Solution Chem.* **1984**, *13*, 673–683.
- (40) Burgot, J. L. *Chimie analytique et équilibres ioniques*, Editions Tech&Doc, Lavoisier, Paris, 2011.
- (41) Baes, C. F. The estimation of bisulfate ion dissociation in sulfuric acid-sodium sulfate solutions. *J. Am. Chem. Soc.* **1957**, *79*, 5611–5616.
- (42) Marshall, W. L.; Jones, E. V. Second dissociation constant of sulfuric acid from 25 to 350° Evaluated from solubilities of Calcium Sulfate in Sulfuric Acid Solutions. *J. Phys. Chem. E* **1966**, *70*, 4028–4040.
- (43) Clegg, S. L.; Rard, J. A.; Pitzer, K. S. Thermodynamic Properties of 0-6 mol.kg<sup>-1</sup> Aqueous Sulfuric Acid from 273.15 to 328.15 K. *J. Chem. Soc., Faraday Trans.* **1994**, *90*, 1875–1894.
- (44) Haynes, W. M.; Lide, D. R.; Brunot, T. J. *Handbook of Chemistry and Physics*, 97th ed.; US: CRC Press: Taylor & Francis Group: Boca Raton, 2016–2017.