



HAL
open science

Existence, uniqueness and ergodicity for the centered Fleming-Viot process

Vincent Hass, Nicolas Champagnat

► **To cite this version:**

Vincent Hass, Nicolas Champagnat. Existence, uniqueness and ergodicity for the centered Fleming-Viot process. 2022. hal-03596777v1

HAL Id: hal-03596777

<https://hal.science/hal-03596777v1>

Preprint submitted on 3 Mar 2022 (v1), last revised 13 Jul 2023 (v4)

HAL is a multi-disciplinary open access archive for the deposit and dissemination of scientific research documents, whether they are published or not. The documents may come from teaching and research institutions in France or abroad, or from public or private research centers.

L'archive ouverte pluridisciplinaire **HAL**, est destinée au dépôt et à la diffusion de documents scientifiques de niveau recherche, publiés ou non, émanant des établissements d'enseignement et de recherche français ou étrangers, des laboratoires publics ou privés.



Distributed under a Creative Commons Attribution 4.0 International License

Existence, uniqueness and ergodicity for the centered Fleming-Viot process

NICOLAS CHAMPAGNAT*, VINCENT HASS*¹

MARCH 3, 2022

* *Université de Lorraine, CNRS, Inria, IECL, F-54000 Nancy, France*

Abstract. Motivated by questions of ergodicity for shift invariant FLEMING-VIOT process, we consider the centered FLEMING-VIOT process $(Z_t)_{t \geq 0}$ defined by $Z_t := \tau_{-(\text{id}, Y_t)} \# Y_t$, where $(Y_t)_{t \geq 0}$ is the original FLEMING-VIOT process. Our goal is to characterise the centered FLEMING-VIOT process with a martingale problem. To establish the existence of a solution to this martingale problem, we exploit the original FLEMING-VIOT martingale problem and asymptotic expansions. The proof of uniqueness is based on a weakened version of the duality method, allowing us to prove uniqueness for initial conditions admitting finite moments. We also provide counter examples showing that our approach based on the duality method cannot be expected to give uniqueness for more general initial conditions. Finally, we establish ergodicity properties with exponential convergence in total variation for the centered FLEMING-VIOT process and characterise the invariant measure.

Keywords. Measure-valued diffusion processes, FLEMING-VIOT process, Martingale problems, Duality method, Exponential ergodicity in total variation, DONNELLY-KURTZ's modified look-down.

MSC subject classification. Primary 37A25, 37A30, 60G44, 60J60, 60J68; Secondary 60B10, 60G09, 60J76, 60J90, 92D10.

1 Introduction

FLEMING and VIOT have introduced in [26] a probability-measure-valued stochastic process modeling the dynamics of the distribution of allelic frequencies in a *selectively neutral* genetic population as influenced by mutation and random genetic drift: the original FLEMING-VIOT process. The initial model of [26] was progressively enriched with further mechanisms of Darwinian evolution: selection [26, 20, 22, 8, 17], recombination [24, 22] or the effect of an environment [27]. FLEMING and VIOT characterise in [26] the law of their process as a solution

¹Corresponding author at: IECL - Site de Nancy Faculté des Sciences et Technologies Campus, Boulevard des Aiguillettes 54506 Vandœuvre-lès-Nancy, Cedex, France.

E-mail addresses: nicolas.champagnat@inria.fr (Nicolas Champagnat), vincent.hass@inria.fr (Vincent Hass).

of a STROOCK-VARADHAN measure-valued martingale problem [50] both in the selective neutral case and the case with selection. To obtain the existence of such solution on a compact metric space, their method is based on discretization of the mutation operator and tightness arguments. An alternative approach is used, in the studies [39, 40, 31, 30, 49] based on the OHTA-KIMURA model [41, 42] and in the references [26, 9, 22, 16] based on its continuous-time version: the MORAN model (also called *continuous-state stepwise mutation model*). If we denote by N the population size, these authors construct a particle process whose limiting behavior is analysed under the assumptions that the mutation step is proportional to $1/\sqrt{N}$ and on the time scale $(Nt)_{t \geq 0}$. In [27], another particle process, based on the lockdown construction [13] is used to show the existence of the FLEMING-VIOT process in a random environment. This lockdown construction also allows to analyse sample path properties of the process and has been used in numerous references since then, such as [14] [16, Chapter 5].

In [26], uniqueness of the solution to the FLEMING-VIOT martingale problem in the selective neutral case, is proved using uniqueness of moments of certain finite-dimensional distributions and arguments on semigroup. However, in the case where natural selection acts, the previous method fails, but the result can be obtained from a version of the CAMERON-MARTIN-GIRSANOV formula [8, Chapter 10] [7, Theorem 5.1]. See also [23] for an application of this method in the case of unbounded selection function. In most references such as [16, 9, 19, 20, 22, 23], under a variety of assumptions, the *duality method* [25, Proposition 4.4.7] is used to prove the uniqueness of the FLEMING-VIOT process. The idea is to relate the distribution of the original process with that of a simple process, called *dual process*. This leads to a duality relation which ensures that two solutions to the martingale problem have the same 1-dimensional marginal laws. Uniqueness of the solution to the martingale problem then follows from MARKOV's property [25, Theorem 4.4.2]. Other methods are used in some references: [10] makes use of resolvent estimates; [44, 43] prove existence and uniqueness of FLEMING-VIOT processes with *unbounded selection* intensity functions by using DIRICHLET's forms.

Questions of ergodicity of the FLEMING-VIOT process were also the subject of many works. Let E be a Polish space and $\mathcal{B}(E)$ the BOREL σ -field on E . Let us recall that an E -valued MARKOV process $(Z_t)_{t \geq 0}$ is *weakly ergodic* if for all continuous functions f on E

$$\lim_{t \rightarrow +\infty} \mathbb{E}_{\nu_0} (f(Z_t)) = \int_E f(x) \nu_0(dx)$$

for every initial condition ν_0 and *strongly ergodic* if

$$\lim_{t \rightarrow +\infty} \sup_{B \in \mathcal{B}(E)} |\mathbb{P}_x(Z_t \in B) - \nu_0(B)| = 0, \quad x \in E.$$

If E is compact, for mutation operators A whose closure generates a FELLER semigroup on the space of continuous functions and such that there is a unique probability measure ν_0 on E satisfying $\int_E Af(x) \nu_0(dx) = 0$, some ergodicity results for the FLEMING-VIOT process are obtained in [22]. More precisely, in the selectively neutral case and without recombination, a simple proof of weak ergodicity of the FLEMING-VIOT process is given using duality arguments whereas coupling arguments provide an approach to strong ergodicity. These results were extended in [21] to models with recombination and in [23] to models with unbounded selection,

with the additional tool of DAWSON's GIRSANOV-type formula for strong ergodicity. In the special case where the mutation operator of the FLEMING-VIOT process has the form

$$Af(x) = \frac{\theta}{2} \int_E (f(y) - f(x)) P(x, dy), \quad \theta \in \mathbb{R}_+^*, f \in \mathcal{D}(A), \quad (1)$$

it is proved in [22] that the FLEMING-VIOT process has a reversible stationary distribution if $P(x, dy) = \nu(dy)$ (see [34] for a converse result). For the mutation operator (1), it is proved in [19, 20] and [8, Theorem 8.2.1] that the FLEMING-VIOT process is purely atomic for every time, in other words the solutions of the martingale problem take values in the set of purely atomic probability measures. In [24], the ergodicity result of [21] was extended to the weak atomic topology.

However, if we consider the case where the mutation operator is the Laplacian on \mathbb{R}^d , there exists no stationary distribution [22, 34], [25, Problem 11 p.450]. Instead the process exhibits a wandering phenomenon [9]. Nevertheless, [49, 22] considered the FLEMING-VIOT process shifted by minus its empirical mean and established existence of a unique invariant measure and weak ergodicity for this process using moment and duality arguments. More precisely in [22], thanks to some estimates of the original FLEMING-VIOT dual process and the finiteness of all moments of the FLEMING-VIOT process shifted by minus its empirical mean for any time t , the authors obtain an expression for these in the asymptotic $t \rightarrow +\infty$. Then, by tension arguments and characterisation of the limit, the result follows. In [49], an analogous approach is used for the continuous-state stepwise mutation model.

In this paper we are interested in the FLEMING-VIOT process shifted by minus its empirical mean, which we call *centered FLEMING-VIOT process*. As in previous works it is natural to ask questions of existence, uniqueness and ergodicity. Moreover, the study of this process was motivated by biological questions in adaptive dynamics. The theory of adaptive dynamics [38] is based on biological assumptions of *rare* and *small mutations* and of *large population* under which an ODE approximating the population evolutionary dynamics, the *Canonical Equation of Adaptive Dynamics* (CEAD) was proposed [11]. Two mathematical approaches were developed to give a proper mathematical justification of this theory: a *deterministic* one [12, 46, 37], and a *stochastic* one [3, 6, 5]. Despite their success, the proposed approaches are criticised by biologists [51, 47]. Among the biological assumptions of adaptive dynamics, the assumption of rare mutations is the most criticised as unrealistic. In order to solve this problem, we propose to apply an asymptotic of small mutations and large population, but *frequent mutations*. After conveniently scaling the population state, this leads to a *slow-fast dynamics* [45, 33], where the fast dynamic appears to be given by a discrete version of the centered FLEMING-VIOT process [4]. This explains why we are interested in ergodicity properties of such processes.

To establish the existence of the centered FLEMING-VIOT process, we characterise it as a solution of a measure-valued martingale problem and that we called the *centered FLEMING-VIOT martingale problem*. Our method is to exploit the original FLEMING-VIOT martingale problem and asymptotic expansions. An additional difficulty occurs in our case since we need to apply the original FLEMING-VIOT martingale problem to *predictable test functions*. This requires to extend the martingale problem to such test functions using *regular conditional probabilities*. The proof of uniqueness of the solution of the centered FLEMING-VIOT martingale problem is based on duality method as in the previous works. However, additional difficulties occur in our case since bounds on the dual process are much harder to obtain and the duality identity

can only be proved in a weakened version. In particular, our uniqueness result only holds for initial conditions admitting finite moments. We also provide a counter example showing that our uniqueness result is optimal in the sense we cannot expect to obtain uniqueness for more general initial conditions using the duality approach. Finally, we obtain strong ergodicity properties of the centered FLEMING-VIOT process that extend the weak ergodicity results obtained in [49, 22]. To this aim, we construct the centered version of the MORAN process and we prove that converges in law to the centered FLEMING-VIOT process. Exploiting relationship between the MORAN model and the KINGMAN coalescent, we obtain a result of exponential ergodicity in total variation for the centered MORAN model uniform in the number of particles. This result is propagated to the centered FLEMING-VIOT process by coupling arguments. Using another strategy proposed by [49, 22], based on the DONNELLY-KURTZ modified look-down [14] we give a characterisation of the unique invariant measure of the centered FLEMING-VIOT process.

This paper is organized as follows. In Section 2 we define the martingale problem for the centered FLEMING-VIOT process and establish an existence result. We give also some equivalent extensions to the centered FLEMING-VIOT martingale problem and some properties of the centered FLEMING-VIOT process. In Section 3 we prove uniqueness to the centered FLEMING-VIOT martingale problem for initial conditions admitting finite moments and we discuss this assumption. In Section 4, we establish exponential convergence in total variation for the centered FLEMING-VIOT process to its unique invariant measure and provide a characterisation of this measure based on the DONNELLY-KURTZ modified look-down. Finally in Sections 5 and 6, we prove respectively the main results of existence and uniqueness of the solution of the centered FLEMING-VIOT martingale problem. The paper ends with an appendix gathering technical lemmas for the existence proof.

2 Existence for the centered Fleming-Viot process

In this section, our aim is to define the martingale problem for the centered FLEMING-VIOT process and to establish an existence result. This result is stated in Subsection 2.1. Then, we give in Subsection 2.2, the framework and ideas of the proof. In Subsection 2.3, we give some equivalent extensions to the centered FLEMING-VIOT martingale problem with different sets of test functions. We end this section by giving some interesting results about the centered FLEMING-VIOT process: it satisfies the MARKOV property (Subsubsection 2.4.1), admits moments finite (Subsubsection 2.4.2) and has compact support (Subsubsection 2.4.3).

2.1 Centered Fleming-Viot martingale problem and main result

The original FLEMING-VIOT process is a measure-valued diffusion in $\mathcal{M}_1(\mathbb{R})$, the set of probability measures on \mathbb{R} , which is endowed with the topology of weak convergence making it a Polish space [2]. If \mathcal{I} is an interval of \mathbb{R} , then for all $\ell \in \mathbb{N}$, we denote by $\mathcal{C}^\ell(\mathcal{I}, \mathbb{R})$ the space of functions of class \mathcal{C}^ℓ from \mathcal{I} to \mathbb{R} . For $\ell \in \mathbb{N}$, we denote by $\mathcal{C}_b^\ell(\mathbb{R}, \mathbb{R})$ the space of real bounded functions of class $\mathcal{C}^\ell(\mathbb{R}, \mathbb{R})$ with bounded derivatives. We consider the filtered probability space $(\Omega, \mathcal{F}, (\mathcal{F}_t)_{t \geq 0})$ where

$$\Omega := \mathcal{C}^0([0, +\infty), \mathcal{M}_1(\mathbb{R}))$$

is endowed with the SKOROHOD topology, \mathcal{F} is the associated BOREL σ -field and $(\mathcal{F}_t)_{t \geq 0}$ is the canonical filtration. The centered FLEMING-VIOT process is a measure-valued diffusion in

$$\mathcal{M}_1^{c,2}(\mathbb{R}) := \left\{ \mu \in \mathcal{M}_1(\mathbb{R}) \mid \int_{\mathbb{R}} |x|^2 \mu(dx) < \infty, \int_{\mathbb{R}} x \mu(dx) = 0 \right\}$$

which is endowed with the trace of the topology of weak convergence on $\mathcal{M}_1(\mathbb{R})$. We consider the filtered probability space $(\tilde{\Omega}, \tilde{\mathcal{F}}, (\tilde{\mathcal{F}}_t)_{t \geq 0})$ where

$$\tilde{\Omega} := \left\{ X \in \mathcal{C}^0([0, +\infty), \mathcal{M}_1^{c,2}(\mathbb{R})) \mid \forall T > 0, \sup_{0 \leq t \leq T} \int_{\mathbb{R}} |x|^2 X_t(dx) < \infty \right\}$$

is endowed with the trace of the SKOROHOD topology on Ω , $\tilde{\mathcal{F}}$ is the trace of the σ -field \mathcal{F} and $(\tilde{\mathcal{F}}_t)_{t \geq 0}$ is the trace of the filtration $(\mathcal{F}_t)_{t \geq 0}$. We introduce several notations that we use repeatedly in the sequel. For a measurable real bounded function f and a measure $\nu \in \mathcal{M}_1(\mathbb{R})$, we denote $\langle f, \nu \rangle := \int_{\mathbb{R}} f(x) \nu(dx)$. We denote by id the identity function. We denote $\mathbb{N} := \{0, 1, 2, \dots\}$ and $\mathbb{N}^* := \mathbb{N} \setminus \{0\}$. For all $k \in \mathbb{N}$ and for all $\nu \in \mathcal{M}_1(\mathbb{R})$, we also denote

$$M_k(\nu) := \int_{\mathbb{R}} |x - \langle \text{id}, \nu \rangle|^k \nu(dx).$$

In particular, for all $k \in \mathbb{N}$ and for all $\mu \in \mathcal{M}_1^{c,2}(\mathbb{R})$, $M_k(\mu) = \langle |\text{id}|^k, \mu \rangle$.

Definition 2.1. A probability measure $\mathbb{P}_\mu \in \mathcal{M}_1(\tilde{\Omega})$ is said to solve the centered FLEMING-VIOT martingale problem with initial condition $\mu \in \mathcal{M}_1^{c,2}(\mathbb{R})$, if the canonical process $(X_t)_{t \geq 0}$ on $\tilde{\Omega}$ satisfies $\mathbb{P}_\mu(X_0 = \mu) = 1$ and for each $F \in \mathcal{C}^2(\mathbb{R}, \mathbb{R})$ and $g \in \mathcal{C}_b^2(\mathbb{R}, \mathbb{R})$,

$$\begin{aligned} \widehat{M}_t^F(g) &:= F(\langle g, X_t \rangle) - F(\langle g, X_0 \rangle) - \int_0^t F'(\langle g, X_s \rangle) \left(\left\langle \frac{g''}{2}, X_s \right\rangle \right. \\ &\quad \left. + \gamma [\langle g'', X_s \rangle M_2(X_s) - 2 \langle g' \times \text{id}, X_s \rangle] \right) ds \\ &\quad - \gamma \int_0^t F''(\langle g, X_s \rangle) [\langle g^2, X_s \rangle - \langle g, X_s \rangle^2 \\ &\quad + \langle g', X_s \rangle^2 M_2(X_s) - 2 \langle g', X_s \rangle \langle g \times \text{id}, X_s \rangle] ds \end{aligned} \tag{2}$$

is a continuous \mathbb{P}_μ -martingale in $L^2(\tilde{\Omega})$ with quadratic variation process

$$\begin{aligned} \langle \widehat{M}^F(g) \rangle_t &= 2\gamma \int_0^t [F'(\langle g, X_s \rangle)]^2 [\langle g^2, X_s \rangle - \langle g, X_s \rangle^2 \\ &\quad + \langle g', X_s \rangle^2 M_2(X_s) - 2 \langle g', X_s \rangle \langle g \times \text{id}, X_s \rangle] ds. \end{aligned} \tag{3}$$

We recall that the probability measure $\mathbb{P}_\nu^{FV} \in \mathcal{M}_1(\Omega)$ is said to solve the *original FLEMING-VIOT martingale problem* with initial condition $\nu \in \mathcal{M}_1(\mathbb{R})$ if the canonical process $(Y_t)_{t \geq 0}$ on

Ω satisfies $\mathbb{P}_\nu^{FV}(Y_0 = \nu) = 1$ and for each $F \in \mathcal{C}^2(\mathbb{R}, \mathbb{R})$ and $g \in \mathcal{C}_b^2(\mathbb{R}, \mathbb{R})$,

$$\begin{aligned} M_t^F(g) &:= F(\langle g, Y_t \rangle) - F(\langle g, Y_0 \rangle) - \int_0^t F'(\langle g, Y_s \rangle) \left\langle \frac{g''}{2}, Y_s \right\rangle ds \\ &\quad - \gamma \int_0^t F''(\langle g, Y_s \rangle) [\langle g^2, Y_s \rangle - \langle g, Y_s \rangle^2] ds \end{aligned} \quad (4)$$

is a square integrable \mathbb{P}_ν^{FV} -martingale whose martingale bracket satisfies for all $G, H \in \mathcal{C}^2(\mathbb{R}, \mathbb{R})$ and for all $g, h \in \mathcal{C}_b^2(\mathbb{R}, \mathbb{R})$,

$$\langle M^G(g), M^H(h) \rangle_t = 2\gamma \int_0^t G'(\langle g, Y_s \rangle) H'(\langle h, Y_s \rangle) [\langle gh, Y_s \rangle - \langle g, Y_s \rangle \langle h, Y_s \rangle] ds. \quad (5)$$

In the population genetics literature, the terms involving the first order derivative F' describe the effect of the mutation whereas the one involving the second order derivative F'' describe the effect of the random genetic drift. It is well-known that, for all $\nu \in \mathcal{M}_1(\mathbb{R})$, there exists a unique probability measure $\mathbb{P}_\nu^{FV} \in \mathcal{M}_1(\Omega)$ satisfying the previous martingale problem (4) [26, Theorem 3].

Remark 2.2. *The additional terms in the martingale problem (2) with respect to the martingale problem (4) describe the impact of centering and ensure that at all times the centered FLEMING-VIOT process remains $\mathcal{M}_1^{c,2}(\mathbb{R})$ -valued.*

The main result of this subsection is the following:

Theorem 2.3. *For all $\mu \in \mathcal{M}_1^{c,2}(\mathbb{R})$, there exists a probability measure $\mathbb{P}_\mu \in \mathcal{M}_1(\tilde{\Omega})$ satisfying the martingale problem of Definition 2.1, given by the law of the process $(Z_t)_{t \geq 0}$ defined by*

$$Z_t := \tau_{-\langle \text{id}, Y_t \rangle} \sharp Y_t := Y_t(\cdot + \langle \text{id}, Y_t \rangle), \quad t \geq 0 \quad (6)$$

where $(Y_t)_{t \geq 0}$ is the original FLEMING-VIOT process.

2.2 Sketch of proof of Theorem 2.3

The proof is based on the original FLEMING-VIOT martingale problem (4).

2.2.1 Framework and objective of the proof

For all $k \in \mathbb{N}$, we denote

$$\mathcal{M}_1^k(\mathbb{R}) := \left\{ \nu \in \mathcal{M}_1(\mathbb{R}) \left| \langle |\text{id}|^k, \nu \rangle < \infty \right. \right\}.$$

Let $\nu \in \mathcal{M}_1^2(\mathbb{R})$ and \mathbb{P}_ν^{FV} the unique solution to the original FLEMING-VIOT martingale problem (4). As the support of the original FLEMING-VIOT process is compact at all positive times \mathbb{P}_ν^{FV} -a.s. [36], $\mathbb{P}_\nu^{FV}(\mathcal{C}^0([0, +\infty), \mathcal{M}_1^2(\mathbb{R}))) = 1$. Moreover, as $t \mapsto \langle \text{id}, Y_t \rangle$ is continuous \mathbb{P}_ν^{FV} -a.s. (Lemma 5.1 (2)), we deduce that, for all $t \geq 0$, Z_t given by (6), is well defined and is a random variable on $\tilde{\Omega}$.

When the dependency of Y and Z on the initial condition ν of Y is important, we shall use the notation $(Y_t^\nu)_{t \geq 0}$ and $(Z_t^\nu)_{t \geq 0}$ instead of $(Y_t)_{t \geq 0}$ and $(Z_t)_{t \geq 0}$. Our goal is to prove that the law of the process $(Z_t)_{t \geq 0}$ denoted by $\mathbb{P}_{\tau_{-(\text{id}, \nu)}^\# \nu}^{FVc}$ solves the martingale problem of Definition 2.1 with initial condition $\tau_{-(\text{id}, \nu)}^\# \nu$. Note that the notation $\mathbb{P}_{\tau_{-(\text{id}, \nu)}^\# \nu}^{FVc}$ is justified because the original FLEMING-VIOT process is invariant by translation:

Proposition 2.4. *Let $\nu \in \mathcal{M}_1^+(\mathbb{R})$ and $a \in \mathbb{R}$. Then, the law of Z_t^ν is the same as the law of $Z_t^{\tau_a^\# \nu}$.*

Proof. By translation invariance of the original FLEMING-VIOT process, the process $(\tau_{-a}^\# Y_t^{\tau_a^\# \nu})_{t \geq 0}$ has the same law as the process $(Y_t^\nu)_{t \geq 0}$. Now,

$$Z_t^{\tau_a^\# \nu} = \tau_{-\langle \text{id}, Y_t^{\tau_a^\# \nu} \rangle^\#} Y_t^{\tau_a^\# \nu} = \tau_{-\langle \text{id}, \tau_{-a}^\# Y_t^{\tau_a^\# \nu} \rangle^\#} (\tau_{-a}^\# Y_t^{\tau_a^\# \nu}).$$

Thus, $(Z_t^{\tau_a^\# \nu})_{t \geq 0}$ has the same law as $(\tau_{-\langle \text{id}, Y_t^\nu \rangle^\#} Y_t^\nu)_{t \geq 0} = (Z_t^\nu)_{t \geq 0}$. \square

2.2.2 Outline of the proof

We restrict to the time interval $[0, T]$ for $T > 0$ arbitrary. By standard arguments, it is sufficient to prove that, for all $F \in \mathcal{C}^2(\mathbb{R}, \mathbb{R})$ and $g \in \mathcal{C}_b^2(\mathbb{R}, \mathbb{R})$,

$$\begin{aligned} F(\langle g, Z_t \rangle) - F(\langle g, Z_0 \rangle) - \int_0^t F'(\langle g, Z_s \rangle) \left(\left\langle \frac{g''}{2}, Z_s \right\rangle \right. \\ \left. + \gamma [\langle g'', Z_s \rangle M_2(Z_s) - 2 \langle g' \times \text{id}, Z_s \rangle] \right) ds \\ - \gamma \int_0^t F''(\langle g, Z_s \rangle) [\langle g^2, Z_s \rangle - \langle g, Z_s \rangle^2 \\ + \langle g', Z_s \rangle^2 M_2(Z_s) - 2 \langle g', Z_s \rangle \langle g \times \text{id}, Z_s \rangle] ds \end{aligned} \quad (7)$$

is a \mathbb{P}_ν^{FV} -martingale, $\nu \in \mathcal{M}_1^+(\mathbb{R})$. We start by assuming $F, g \in \mathcal{C}_b^4(\mathbb{R}, \mathbb{R})$ and we seek for the DOOB's semi-martingale decomposition of

$$F_g(Z_t) := F(\langle g, Z_t \rangle) = F(\langle g \circ \tau_{-(\text{id}, Y_t)}, Y_t \rangle),$$

using the original FLEMING-VIOT martingale problem (4). However, $F(\langle g \circ \tau_{-(\text{id}, Y_t)}, Y_t \rangle)$ does not take the form $H(\langle h, Y_t \rangle)$ with *deterministic* h . Therefore, we cannot apply (4) directly. To get over this difficulty, we consider for $t \in [0, T]$, an increasing sequence $0 = t_0^n < t_1^n < \dots < t_{p_n}^n = T$ of subdivisions of $[0, T]$ whose mesh tends to 0. We can observe that

$$\begin{aligned} F_g(Z_t) - F_g(Z_0) &= \sum_{i=0}^{p_n-1} \{F_g(Z_{t_{i+1}^n \wedge t}) - F_g(Z_{t_i^n \wedge t})\} \\ &= \sum_{i=1}^{p_n-1} \left\{ F \left(\left\langle g \circ \tau_{-\langle \text{id}, Y_{t_{i+1}^n \wedge t} \rangle}, Y_{t_{i+1}^n \wedge t} \right\rangle \right) - F \left(\left\langle g \circ \tau_{-\langle \text{id}, Y_{t_i^n \wedge t} \rangle}, Y_{t_i^n \wedge t} \right\rangle \right) \right\}. \end{aligned}$$

Using asymptotic expansions (see Lemma A.1 with $p = 1$) of the terms in the previous sum, we prove that

$$F_g(Z_t) - F_g(Z_0) = \sum_{i=0}^{p_n-1} \left\{ (\mathbf{A})_i + (\mathbf{B})_i + O\left(\left|\langle \text{id}, Y_{t_{i+1}^n \wedge t} - Y_{t_i^n \wedge t} \rangle\right|^3\right) \right. \\ \left. + O\left(\sum_{k=0}^2 \left|\langle g^{(k)} \circ \tau_{-\langle \text{id}, Y_{t_i^n \wedge t} \rangle}, Y_{t_{i+1}^n \wedge t} - Y_{t_i^n \wedge t} \rangle\right|^3\right) \right\}, \quad (8)$$

where

$$(\mathbf{A})_i = F' \left(\langle g \circ \tau_{-\langle \text{id}, Y_{t_i^n \wedge t} \rangle}, Y_{t_i^n \wedge t} \rangle \right) \left\{ \langle g \circ \tau_{-\langle \text{id}, Y_{t_i^n \wedge t} \rangle}, Y_{t_{i+1}^n \wedge t} - Y_{t_i^n \wedge t} \rangle \right. \\ \left. - \langle \text{id}, Y_{t_{i+1}^n \wedge t} - Y_{t_i^n \wedge t} \rangle \left[\langle g' \circ \tau_{-\langle \text{id}, Y_{t_i^n \wedge t} \rangle}, Y_{t_i^n \wedge t} \rangle + \langle g' \circ \tau_{-\langle \text{id}, Y_{t_i^n \wedge t} \rangle}, Y_{t_{i+1}^n \wedge t} - Y_{t_i^n \wedge t} \rangle \right] \right. \\ \left. + \frac{1}{2} \langle \text{id}, Y_{t_{i+1}^n \wedge t} - Y_{t_i^n \wedge t} \rangle^2 \langle g'' \circ \tau_{-\langle \text{id}, Y_{t_i^n \wedge t} \rangle}, Y_{t_i^n \wedge t} \rangle \right\}, \quad (9)$$

$$(\mathbf{B})_i = \frac{F'' \left(\langle g \circ \tau_{-\langle \text{id}, Y_{t_i^n \wedge t} \rangle}, Y_{t_i^n \wedge t} \rangle \right)}{2} \left\{ \langle g \circ \tau_{-\langle \text{id}, Y_{t_i^n \wedge t} \rangle}, Y_{t_{i+1}^n \wedge t} - Y_{t_i^n \wedge t} \rangle^2 \right. \\ \left. + \langle \text{id}, Y_{t_{i+1}^n \wedge t} - Y_{t_i^n \wedge t} \rangle^2 \langle g' \circ \tau_{-\langle \text{id}, Y_{t_i^n \wedge t} \rangle}, Y_{t_i^n \wedge t} \rangle^2 \right. \\ \left. - 2 \langle g \circ \tau_{-\langle \text{id}, Y_{t_i^n \wedge t} \rangle}, Y_{t_{i+1}^n \wedge t} - Y_{t_i^n \wedge t} \rangle \langle \text{id}, Y_{t_{i+1}^n \wedge t} - Y_{t_i^n \wedge t} \rangle \langle g' \circ \tau_{-\langle \text{id}, Y_{t_i^n \wedge t} \rangle}, Y_{t_i^n \wedge t} \rangle \right\}, \quad (10)$$

and where $g^{(j)}$, $j \in \{0, 1, 2\}$, denotes the j^{th} derivative of g . Several steps are described in Section 5 to obtain the semi-martingale decomposition of each term of the previous sum. By making the step of the subdivision tend towards 0, we obtain the expected result. By density arguments, the martingale problem (4) satisfied by $F, g \in \mathcal{C}_b^4(\mathbb{R}, \mathbb{R})$ is extended, in Subsection 5.6, to the case where $F \in \mathcal{C}^2(\mathbb{R}, \mathbb{R})$ and $g \in \mathcal{C}_b^2(\mathbb{R}, \mathbb{R})$. Once we have proved that $\widehat{M}^F(g)$ is a martingale, using Itô's formula and the martingale problem (2) with localization sequence, we deduce the value of $\langle \widehat{M}^F(g) \rangle_t$ and by FATOU's lemma that $\widehat{M}_t^F(g) \in L^2(\widetilde{\Omega})$.

2.3 Some extensions to the centered Fleming-Viot martingale problem

Our goal is now to give some extensions to the martingale problem (2) which will be useful to compute the martingale bracket between two martingales of the form (2) and prove uniqueness of the solution of the martingale problem of the centered FLEMING-VIOT in Section 3.

2.3.1 Extensions to multiple variables

We firstly introduce the version of the centered FLEMING-VIOT martingale problem with $p \in \mathbb{N}^*$ variables.

Definition 2.5. The probability measure $\mathbb{P}_\mu \in \mathcal{M}_1(\tilde{\Omega})$ is said to solve the centered FLEMING-VIOT martingale problem with p variables and with initial condition $\mu \in \mathcal{M}_1^{c,2}(\mathbb{R})$, if the canonical process $(X_t)_{t \geq 0}$ on $\tilde{\Omega}$ satisfies $\mathbb{P}_\mu(X_0 = \mu) = 1$ and for each $F \in \mathcal{C}^2(\mathbb{R}^p, \mathbb{R})$ and $g = (g_1, \dots, g_p) \in \mathcal{C}_b^2(\mathbb{R}^p, \mathbb{R})$,

$$\begin{aligned}
\widehat{M}_t^F(g) &:= F(\langle g_1, X_t \rangle, \dots, \langle g_p, X_t \rangle) - F(\langle g_1, X_0 \rangle, \dots, \langle g_p, X_0 \rangle) \\
&\quad - \int_0^t \sum_{k=1}^p \partial_k F(\langle g_1, X_s \rangle, \dots, \langle g_p, X_s \rangle) \times \\
&\quad \quad \left[\left\langle \frac{g_k''}{2}, X_s \right\rangle + \gamma(\langle g_k'', X_s \rangle M_2(X_s) - 2\langle g_k' \times \text{id}, X_s \rangle) \right] ds \\
&\quad - \gamma \int_0^t \sum_{i,j=1}^p \partial_{ij}^2 F(\langle g_1, X_s \rangle, \dots, \langle g_p, X_s \rangle) \times \\
&\quad \quad \left[\langle g_i g_j, X_s \rangle - \langle g_i, X_s \rangle \langle g_j, X_s \rangle + \langle g_i', X_s \rangle \langle g_j', X_s \rangle M_2(X_s) \right. \\
&\quad \quad \left. - \langle g_i', X_s \rangle \langle g_j \times \text{id}, X_s \rangle - \langle g_j', X_s \rangle \langle g_i \times \text{id}, X_s \rangle \right] ds
\end{aligned} \tag{11}$$

is a continuous \mathbb{P}_μ -martingale in $L^2(\tilde{\Omega})$.

We will see in Section 3 that this martingale problem admits a unique solution which is the same as the solution of the martingale problem (2) if the initial condition has all its moments finite. For the moment, we can prove:

Theorem 2.6. For all $\mu \in \mathcal{M}_1^{c,2}(\mathbb{R})$, the probability measure \mathbb{P}_μ constructed in Theorem 2.3, satisfies the martingale problem of Definition 2.5.

Proof. We can deduce the result from the original FLEMING-VIOT martingale problem with p variables [9] given by (12) below, following exactly the same method as for the proof of Theorem 2.3. We recall that, the probability measure $\mathbb{P}_\nu^{FV} \in \mathcal{M}_1(\Omega)$ is said to solve the *original FLEMING-VIOT martingale problem* with p variables and with initial condition $\nu \in \mathcal{M}_1(\mathbb{R})$, if the canonical process $(Y_t)_{t \geq 0}$ on Ω satisfies $\mathbb{P}_\nu^{FV}(Y_0 = \nu) = 1$ and for each $F \in \mathcal{C}^2(\mathbb{R}^p, \mathbb{R})$ and $g = (g_1, \dots, g_p) \in \mathcal{C}_b^2(\mathbb{R}^p, \mathbb{R})$,

$$\begin{aligned}
M_t^F(g) &:= F(\langle g_1, Y_t \rangle, \dots, \langle g_p, Y_t \rangle) - F(\langle g_1, Y_0 \rangle, \dots, \langle g_p, Y_0 \rangle) \\
&\quad - \int_0^t \sum_{k=1}^p \partial_k F(\langle g_1, Y_s \rangle, \dots, \langle g_p, Y_s \rangle) \left\langle \frac{g_k''}{2}, Y_s \right\rangle ds \\
&\quad - \gamma \int_0^t \sum_{i,j=1}^p \partial_{ij}^2 F(\langle g_1, Y_s \rangle, \dots, \langle g_p, Y_s \rangle) [\langle g_i g_j, Y_s \rangle - \langle g_i, Y_s \rangle \langle g_j, Y_s \rangle] ds
\end{aligned} \tag{12}$$

is a \mathbb{P}_ν^{FV} -martingale. As mentionned in [9, Theorem 5.1], the solution \mathbb{P}_ν^{FV} of the martingale problem (4) is the unique solution to the previous martingale problem (12). Here, (8) has to be replaced by the general version of Lemma A.1. \square

This version allows us to compute the martingale bracket $\langle \widehat{M}_t^G(g), \widehat{M}_t^H(h) \rangle_t$ in a similar form as (5).

Corollary 2.7. *Let $G, H \in \mathcal{C}^2(\mathbb{R}, \mathbb{R})$ and $g, h \in \mathcal{C}_b^2(\mathbb{R}, \mathbb{R})$. Then,*

$$\begin{aligned} \langle \widehat{M}^G(g), \widehat{M}^H(h) \rangle_t &= 2\gamma \int_0^t G'(\langle g, X_s \rangle) H'(\langle h, X_s \rangle) \left[\langle gh, X_s \rangle \right. \\ &\quad - \langle g, X_s \rangle \langle h, X_s \rangle + \langle g', X_s \rangle \langle h', X_s \rangle M_2(X_s) \\ &\quad \left. - \langle g', X_s \rangle \langle h \times \text{id}, X_s \rangle - \langle h', X_s \rangle \langle g \times \text{id}, X_s \rangle \right] ds. \end{aligned}$$

Proof. Using the relation (2) for $\widehat{M}_t^G(g)$ and $\widehat{M}_t^H(h)$, we obtain that

$$\begin{aligned} \widehat{M}_t^G(g) \widehat{M}_t^H(h) &= G(\langle g, X_t \rangle) H(\langle h, X_t \rangle) - G(\langle g, X_0 \rangle) H(\langle h, X_0 \rangle) \\ &\quad - G(\langle g, X_t \rangle) \int_0^t \mathcal{L}_{FVc} H_h(X_s) ds - H(\langle h, X_t \rangle) \int_0^t \mathcal{L}_{FVc} G_g(X_s) ds \\ &\quad + \int_0^t \mathcal{L}_{FVc} G_g(X_s) ds \int_0^t \mathcal{L}_{FVc} H_h(X_s) ds \\ &\quad - G(\langle g, X_0 \rangle) \widehat{M}_t^H(h) - H(\langle h, X_0 \rangle) \widehat{M}_t^G(g). \end{aligned} \tag{13}$$

where \mathcal{L}_{FVc} denotes the generator of the centered FLEMING-VIOT process. From the martingale problem (11) with $p = 2$, $F(x, y) = G(x)H(y)$ and $f = (g, h)$, we deduce that

$$\begin{aligned} &G(\langle g, X_t \rangle) H(\langle h, X_t \rangle) - G(\langle g, X_0 \rangle) H(\langle h, X_0 \rangle) \\ &= \int_0^t G(\langle g, X_s \rangle) \mathcal{L}_{FVc} H_h(X_s) ds + \int_0^t H(\langle h, X_s \rangle) \mathcal{L}_{FVc} G_g(X_s) ds \\ &\quad + \widehat{M}_t^F(f) + 2\gamma \int_0^t G'(\langle g, X_s \rangle) H'(\langle h, X_s \rangle) \left[\langle gh, X_s \rangle - \langle g, X_s \rangle \langle h, X_s \rangle \right. \\ &\quad \left. + \langle g', X_s \rangle \langle h', X_s \rangle M_2(X_s) - \langle g', X_s \rangle \langle h \times \text{id}, X_s \rangle - \langle h', X_s \rangle \langle g \times \text{id}, X_s \rangle \right] ds, \end{aligned}$$

where $(\widehat{M}_t^F(f))_{t \geq 0}$ is a \mathbb{P}_μ -martingale. Using ITÔ's formula for the third and fourth term of the right hand side (13) and noting that

$$\begin{aligned} \int_0^t \mathcal{L}_{FVc} G_g(X_s) ds \int_0^t \mathcal{L}_{FVc} H_h(X_s) ds &= \int_0^t \left[\mathcal{L}_{FVc} G_g(X_s) \left(\int_0^s \mathcal{L}_{FVc} H_h(X_r) dr \right) \right] ds \\ &\quad + \int_0^t \left[\mathcal{L}_{FVc} H_h(X_s) \left(\int_0^s \mathcal{L}_{FVc} G_g(X_r) dr \right) \right] ds, \end{aligned}$$

we deduce the DOOB-MEYER decomposition of $\widehat{M}_t^G(g) \widehat{M}_t^H(h)$:

$$\begin{aligned} \widehat{M}_t^G(g) \widehat{M}_t^H(h) &= \widehat{M}_t^F(f) + 2\gamma \int_0^t G'(\langle g, X_s \rangle) H'(\langle h, X_s \rangle) \left[\langle gh, X_s \rangle - \langle g, X_s \rangle \langle h, X_s \rangle \right. \\ &\quad \left. + \langle g', X_s \rangle \langle h', X_s \rangle M_2(X_s) - \langle g', X_s \rangle \langle h \times \text{id}, X_s \rangle - \langle h', X_s \rangle \langle g \times \text{id}, X_s \rangle \right] ds \\ &\quad - \int_0^t \left(\int_0^s \mathcal{L}_{FVc} H_h(X_r) dr \right) d\widehat{M}_s^G(g) - \int_0^t \left(\int_0^s \mathcal{L}_{FVc} G_g(X_r) dr \right) d\widehat{M}_s^H(h) \\ &\quad - G(\langle g, X_0 \rangle) \widehat{M}_t^H(h) - H(\langle h, X_0 \rangle) \widehat{M}_t^G(g). \end{aligned}$$

The result follows. \square

2.3.2 Extension to product measures

Our goal here is to study the DOOB semi-martingale decomposition of functions of the centered FLEMING-VIOT process of the form

$$\langle f, \mu^n \rangle := \int_{\mathbb{R}} \cdots \int_{\mathbb{R}} f(x_1, \dots, x_n) \mu(dx_1) \cdots \mu(dx_n)$$

with $n \in \mathbb{N}^*$, $\mu \in \mathcal{M}_1^{c,2}(\mathbb{R})$ and $f \in \mathcal{C}_b^2(\mathbb{R}^n, \mathbb{R})$ and μ^n is the n -fold product measure of μ . The previous martingale problem (11) gives heuristics for this issue: for the choice of $F(x_1, \dots, x_n) = \prod_{i=1}^n x_i$, we deduce that for all $\mu \in \mathcal{M}_1^{c,2}(\mathbb{R})$,

$$\begin{aligned} \mathcal{L}_{FVc} \left(\prod_{i=1}^n \langle g_i, \mu \rangle \right) &= \sum_{i=1}^n \left(\left\langle \frac{g_i''}{2}, \mu \right\rangle + \gamma \left[\langle g_i'', \mu \rangle M_2(\mu) - 2 \langle g_i' \times \text{id}, \mu \rangle \right] \right) \prod_{\substack{j=1 \\ j \neq i}}^n \langle g_j, \mu \rangle \\ &\quad + \gamma \sum_{i=1}^n \sum_{\substack{j=1 \\ j \neq i}}^n \left[\langle g_i g_j, \mu \rangle - \langle g_i, \mu \rangle \langle g_j, \mu \rangle + \langle g_i', \mu \rangle \langle g_j', \mu \rangle M_2(\mu) \right. \\ &\quad \left. - \langle g_i', \mu \rangle \langle g_j \times \text{id}, \mu \rangle - \langle g_j', \mu \rangle \langle g_i \times \text{id}, \mu \rangle \right] \prod_{\substack{k=1 \\ k \neq i,j}}^n \langle g_k, \mu \rangle. \end{aligned}$$

We denote by $\mathbf{1} \in \mathbb{R}^n$, the vector whose coordinates are all 1 and by Δ the Laplacian operator on \mathbb{R}^n . The previous relation leads us to introduce, for each $n \in \mathbb{N}^*$ and for all $f \in \mathcal{C}_b^2(\mathbb{R}^n, \mathbb{R})$, the operator $B^{(n)}$ defined by

$$B^{(n)} f(x) := \frac{1}{2} \Delta f(x) - 2\gamma (\nabla f(x) \cdot \mathbf{1})(x \cdot \mathbf{1}), \quad x \in \mathbb{R}^n. \quad (14)$$

Indeed, for the choice $f(x_1, \dots, x_n) = \prod_{i=1}^n g_i(x_i)$ with $g_i \in \mathcal{C}_b^2(\mathbb{R}, \mathbb{R})$, $i \in \{1, \dots, n\}$, we obtain

$$\begin{aligned} B^{(n)} f(x_1, \dots, x_n) &= \sum_{i=1}^n \left[\frac{g_i''(x_i)}{2} - 2\gamma x_i g_i'(x_i) \right] \prod_{\substack{j=1 \\ j \neq i}}^n g_j(x_j) \\ &\quad - \gamma \sum_{i=1}^n \sum_{\substack{j=1 \\ j \neq i}}^n \left[x_j g_j(x_j) g_i'(x_i) + x_i g_i(x_i) g_j'(x_j) \right] \prod_{\substack{k=1 \\ k \neq i,j}}^n g_k(x_k). \end{aligned}$$

Note that,

$$\begin{aligned} \mathcal{L}_{FVc} \left(\prod_{i=1}^n \langle g_i, \mu \rangle \right) &= \langle B^{(n)} f, \mu^n \rangle + \sum_{i=1}^n \gamma \langle g_i'', \mu \rangle M_2(\mu) \prod_{\substack{j=1 \\ j \neq i}}^n \langle g_j, \mu \rangle \\ &\quad + \gamma \sum_{i=1}^n \sum_{\substack{j=1 \\ j \neq i}}^n \left[\langle g_i g_j, \mu \rangle - \langle g_i, \mu \rangle \langle g_j, \mu \rangle + \langle g_i', \mu \rangle \langle g_j', \mu \rangle M_2(\mu) \right] \prod_{\substack{k=1 \\ k \neq i,j}}^n \langle g_k, \mu \rangle. \end{aligned}$$

This leads us to introduce another extension of the martingale problem (2) which will be useful in Section 3 to prove uniqueness.

Definition 2.8. The probability measure $\mathbb{P}_\mu \in \mathcal{M}_1(\tilde{\Omega})$ is said to solve the centered FLEMING-VIOT martingale problem for product measures with initial condition $\mu \in \mathcal{M}_1^{c,2}(\mathbb{R})$, if the canonical process $(X_t)_{t \geq 0}$ on $\tilde{\Omega}$ satisfies $\mathbb{P}_\mu(X_0 = \mu) = 1$, for all $n \in \mathbb{N}^*$, and for each $f \in \mathcal{C}_b^2(\mathbb{R}^n, \mathbb{R})$,

$$\widehat{M}_t^{(n)}(f) := \langle f, X_t^n \rangle - \langle f, X_0^n \rangle - \int_0^t \mathcal{L}_{FVc} \langle f, X_s^n \rangle ds \quad (15)$$

with for all $\mu \in \mathcal{M}_1^{c,2}(\mathbb{R})$ and $f \in \mathcal{C}_b^2(\mathbb{R}^n, \mathbb{R})$,

$$\begin{aligned} \mathcal{L}_{FVc} \langle f, \mu^n \rangle &:= \langle B^{(n)} f, \mu^n \rangle + \gamma \sum_{i=1}^n \sum_{\substack{j=1 \\ j \neq i}}^n [\langle \Phi_{i,j} f, \mu^{n-1} \rangle - \langle f, \mu^n \rangle] \\ &+ \gamma \sum_{i=1}^n \sum_{j=1}^n \langle K_{i,j} f, \mu^{n+1} \rangle \end{aligned} \quad (16)$$

is a continuous \mathbb{P}_μ -martingale in $L^2(\tilde{\Omega})$ where, for all $1 \leq i \leq j \leq n$,

- $\Phi_{i,j} : \mathcal{C}_b^2(\mathbb{R}^n, \mathbb{R}) \rightarrow \mathcal{C}_b^2(\mathbb{R}^{n-1}, \mathbb{R})$ is the function obtained from f by inserting the variable x_i between x_{j-1} and x_j :

$$\Phi_{i,j} f(x_1, \dots, x_{n-1}) = f(x_1, \dots, x_{j-1}, x_i, x_j, x_{j+1}, \dots, x_{n-1}) \quad (17)$$

- $K_{i,j} : \mathcal{C}_b^2(\mathbb{R}^n, \mathbb{R}) \rightarrow \mathcal{C}_b^2(\mathbb{R}^{n+1}, \mathbb{R})$ is defined as

$$K_{i,j} f(x_1, \dots, x_n, x_{n+1}) := \partial_{ij}^2 f(x_1, \dots, x_n) x_{n+1}^2. \quad (18)$$

We will see in Section 3 that this martingale problem admits the same unique solution as the martingale problem (2) if the initial condition has all its moments finite. For the moment, we can prove:

Theorem 2.9. For all $\mu \in \mathcal{M}_1^{c,2}(\mathbb{R})$, the probability measure \mathbb{P}_μ constructed in Theorem 2.3, satisfies the martingale problem of Definition 2.8.

Proof. We can deduce the result from the original FLEMING-VIOT martingale problem for product measures [22] given by (19) below, following exactly the same arguments than for the proof of Theorem 2.3. The probability measure $\mathbb{P}_\nu^{FV} \in \mathcal{M}_1(\Omega)$ is said to solve the *original FLEMING-VIOT martingale problem for product measures* with initial condition $\nu \in \mathcal{M}_1(\mathbb{R})$, if the canonical process $(Y_t)_{t \geq 0}$ on Ω satisfies $\mathbb{P}_\nu^{FV}(Y_0 = \nu) = 1$, for all $n \in \mathbb{N}^*$, and for each $f \in \mathcal{C}_b^2(\mathbb{R}^n, \mathbb{R})$,

$$M_t^{(n)}(f) := \langle f, Y_t^n \rangle - \langle f, Y_0^n \rangle - \int_0^t \mathcal{L}_{FV} \langle f, Y_s^n \rangle ds \quad (19)$$

with for all $\nu \in \mathcal{M}_1(\mathbb{R})$

$$\mathcal{L}_{FV} \langle f, \nu^n \rangle = \left\langle \frac{1}{2} \Delta f, \nu^n \right\rangle + \gamma \sum_{i=1}^n \sum_{\substack{j=1 \\ j \neq i}}^n (\langle \Phi_{i,j} f, \nu^n \rangle - \langle f, \nu^n \rangle)$$

is a \mathbb{P}_ν^{FV} -martingale. By [22, Theorem 3.2], the solution \mathbb{P}_ν^{FV} of the martingale problem (4) is the unique solution to the previous martingale problem (19). \square

2.4 Some properties of the centered Fleming-Viot process

2.4.1 Markov's property

Due to the invariance by translation property of the original FLEMING-VIOT process, we can prove that the centered FLEMING-VIOT process is homogeneous MARKOV.

Proposition 2.10. *The centered FLEMING-VIOT process $(Z_t)_{t \geq 0}$ defined by (6) satisfies the homogeneous MARKOV property: for all measurable bounded function f ,*

$$\forall \mu \in \mathcal{M}_1^{c,2}(\mathbb{R}), \quad \forall t, s > 0, \quad \mathbb{E}_\mu \left(f(Z_{t+s}) \middle| \mathcal{F}_t \right) = \mathbb{E}_{Z_t} (f(Z_s)) \quad \mathbb{P}_\mu\text{-a.s.}$$

Proof. Let $\mu \in \mathcal{M}_1^{c,2}(\mathbb{R})$ and f a measurable bounded function. Let $t, s > 0$. Using the MARKOV property of the original FLEMING-VIOT process $(Y_t)_{t \geq 0}$ we obtain \mathbb{P}_μ -a.s.,

$$\mathbb{E}_\mu \left(f(Z_{t+s}) \middle| \mathcal{F}_t \right) = \mathbb{E}_\mu \left(f(\tau_{-(\text{id}, Y_{t+s})} \# Y_{t+s}) \middle| \mathcal{F}_t \right) = \mathbb{E}_\mu \left(g(Y_{t+s}) \middle| \mathcal{F}_t \right) = \mathbb{E}_{Y_t} (g(Y_s))$$

where the bounded measurable map g is defined on $\mathcal{M}_1^1(\mathbb{R})$ by $g(\nu) := f(\tau_{-(\text{id}, \nu)} \# \nu)$. By invariance by translation of the original FLEMING-VIOT process $(Y_t)_{t \geq 0}$ we obtain under the distribution \mathbb{P}_μ :

$$\begin{aligned} \mathbb{E}_{Y_t} (g(Y_s)) &= \mathbb{E}_{\tau_{-(\text{id}, Y_t)} \# Y_t} (g(\tau_{(\text{id}, Y_t)} \# Y_s)) = \mathbb{E}_{\tau_{-(\text{id}, Y_t)} \# Y_t} (g(Y_s)) = \mathbb{E}_{Z_t} (g(Y_s)) \\ &= \mathbb{E}_{Z_t} (f(Z_s)). \end{aligned} \quad \square$$

2.4.2 Moments and some martingales

Proposition 2.11. *Let $\mu \in \mathcal{M}_1^{c,2}(\mathbb{R})$, possibly random and let \mathbb{P}_μ be a distribution on $\tilde{\Omega}$ satisfying (2) and such that X_0 is equal in law to μ . Let $T > 0$ and $k \in \mathbb{N} \setminus \{0, 1\}$ fixed.*

(1) *If $\mathbb{E}(\langle |\text{id}|^k, \mu \rangle) < \infty$, there exist two constants $C_{k,T}, \tilde{C}_{k,T} > 0$, such that any stochastic process $(X_t)_{0 \leq t \leq T}$ whose law \mathbb{P}_μ satisfies*

$$(a) \quad \sup_{t \in [0, T]} \mathbb{E}(\langle |\text{id}|^k, X_t \rangle) \leq C_{k,T} (1 + \mathbb{E}(\langle |\text{id}|^k, \mu \rangle)), \quad (20)$$

$$(b) \quad \forall \alpha > 0, \quad \mathbb{P}_\mu \left(\sup_{t \in [0, T]} \langle |\text{id}|^k, X_t \rangle \geq \alpha \right) \leq \frac{\tilde{C}_{k,T} (1 + \mathbb{E}(\langle |\text{id}|^k, \mu \rangle))}{\alpha}.$$

(2) *If $\mathbb{E}(\langle |\text{id}|^k, \mu \rangle) < \infty$, respectively $\mathbb{E}(\langle |\text{id}|^{k+1}, \mu \rangle) < \infty$, the process $(\widehat{M}_t^{\text{id}}(\text{id}^k))_{0 \leq t \leq T}$ defined by*

$$\begin{aligned} \widehat{M}_t^{\text{id}}(\text{id}^k) &:= \langle \text{id}^k, X_t \rangle - \langle \text{id}^k, X_0 \rangle - \int_0^t \left\langle \frac{k(k-1)}{2} \text{id}^{k-2}, X_s \right\rangle ds \\ &\quad - \gamma \int_0^t \left[\langle k(k-1) \text{id}^{k-2}, X_s \rangle M_2(X_s) - 2k \langle \text{id}^k, X_s \rangle \right] ds \end{aligned}$$

is a continuous \mathbb{P}_μ -local martingale, respectively a continuous \mathbb{P}_μ -martingale. Moreover, if $\mathbb{E}(\langle |\text{id}|^{2k}, \mu \rangle) < \infty$, $(\widehat{M}^{\text{id}}(\text{id}^k))_{0 \leq t \leq T}$ is a martingale in $L^2(\widetilde{\Omega})$ whose quadratic variation is given by

$$\begin{aligned} \langle M^{\text{id}}(\text{id}^k) \rangle_t &= 2\gamma \int_0^t \left[\langle \text{id}^{2k}, X_s \rangle - \langle \text{id}^k, X_s \rangle^2 + k \langle \text{id}^{k-1}, X_s \rangle^2 M_2(X_s) \right. \\ &\quad \left. - 2k \langle \text{id}^{k-1}, X_s \rangle \langle \text{id}^{k+1}, X_s \rangle \right] ds. \end{aligned}$$

Proof. Step 1. Proof of (1)(a). We prove only the case $k \geq 3$: the case $k = 2$, which is simpler because some terms disappear, is treated in the same way. Let $t \in [0, T]$. We consider a sequence of functions $(g_n)_{n \in \mathbb{N}}$ of class $\mathcal{C}^2(\mathbb{R}, \mathbb{R})$ with compact support satisfying:

- (i) for all $n \in \mathbb{N}$, $|g_n| \leq |\text{id}|$,
- (ii) $\lim_{n \rightarrow +\infty} \|g_n''\|_\infty = 0$,
- (iii) $g_n = \text{id}$ on $[-n, n]$,
- (iv) g_n' is uniformly bounded on \mathbb{R} .

We consider the sequence of functions $(h_n)_{n \in \mathbb{N}}$ defined by $h_n := \sqrt{1 + g_n^2}$ and we deduce from the properties of g_n that for all $n \in \mathbb{N}$, h_n is a non-negative function with compact support, that for all $k \in \mathbb{N}$,

$$(h_n^k)' = k g_n g_n' h_n^{k-2} \quad \text{and} \quad (h_n^k)'' = k (g_n')^2 h_n^{k-4} (h_n^2 + (k-2)g_n^2) + k g_n g_n'' h_n^{k-2},$$

$h_n = h := \sqrt{1 + \text{id}^2}$ on the compact set $[-n, n]$ and $h_n \leq h$ on \mathbb{R} . We consider for all $A \in \mathbb{N}$ and $\ell \in \mathbb{N}$, the stopping time $\tau_{A, \ell} := \inf \{ t \geq 0 \mid \langle |\text{id}|^\ell, X_t \rangle \geq A \}$. Noting that for all $t \in [0, T]$, $n \in \mathbb{N}$ and $k \geq 3$, $\langle h_n^{k-2}, X_t \rangle \leq \langle h_n^k, X_t \rangle^{\frac{k-2}{k}} \leq \langle h^k, X_t \rangle$ and $\langle h_n^{k-2}, X_t \rangle \langle \text{id}^2, X_t \rangle \leq \langle h^k, X_t \rangle$ from HÖLDER's inequality, we deduce from the martingale problem (2) that there exists constants $C_1(k), C_2(k, A) > 0$ such that

$$\begin{aligned} \mathbb{E}(\langle h_n^k, X_{t \wedge \tau_{A, k}} \rangle) &= \mathbb{E}(\langle h_n^k, X_0 \rangle) + \mathbb{E} \left(\int_0^{t \wedge \tau_{A, k}} \left\langle \frac{(h_n^k)''}{2}, X_s \right\rangle ds \right) \\ &\quad + \gamma \mathbb{E} \left(\int_0^{t \wedge \tau_{A, k}} \langle (h_n^k)'', X_s \rangle M_2(X_s) ds \right) - 2\gamma \mathbb{E} \left(\int_0^{t \wedge \tau_{A, k}} \langle (h_n^k)' \times \text{id}, X_s \rangle ds \right) \\ &\leq \mathbb{E}(\langle h_n^k, X_0 \rangle) + k(k-1) \|g_n'\|_\infty^2 \mathbb{E} \left(\int_0^{t \wedge \tau_{A, k}} \left[\frac{1}{2} + \gamma \langle \text{id}^2, X_s \rangle \right] \langle h_n^{k-2}, X_s \rangle ds \right) \\ &\quad + k \|g_n''\|_\infty \mathbb{E} \left(\int_0^{t \wedge \tau_{A, k}} \left[\frac{1}{2} + \gamma \langle \text{id}^2, X_s \rangle \right] \langle h_n^{k-1}, X_s \rangle ds \right) \\ &\quad + 2\gamma k \|g_n'\|_\infty \mathbb{E} \left(\int_0^{t \wedge \tau_{A, k}} \langle h_n^{k-1} \times |\text{id}|, X_s \rangle ds \right) \\ &\leq \mathbb{E}(\langle h^k, X_0 \rangle) + C_1(k) \mathbb{E} \left(\int_0^{t \wedge \tau_{A, k}} \langle h^k, X_s \rangle ds \right) + C_2(k, A) \|g_n''\|_\infty. \end{aligned}$$

By FATOU's lemma we obtain when $n \rightarrow +\infty$,

$$\mathbb{E}(\langle h^k, X_{t \wedge \tau_{A, k}} \rangle) \leq \mathbb{E}(\langle h^k, X_0 \rangle) + C_1(k) \mathbb{E} \left(\int_0^{t \wedge \tau_{A, k}} \langle h^k, X_s \rangle ds \right).$$

By GRONWALL's lemma, we deduce that

$$\mathbb{E} \left(\langle |\text{id}|^k, X_{t \wedge \tau_{A,k}} \rangle \right) \leq \mathbb{E} \left(\langle h^k, X_{t \wedge \tau_{A,k}} \rangle \right) \leq \mathbb{E} \left(\langle h^k, X_0 \rangle \right) \exp(C_1(k)t). \quad (21)$$

In particular, this implies that the sequence $(\tau_{A,k})_{A \in \mathbb{N}}$ converges \mathbb{P}_μ -a.s. to infinity. Indeed, for all $\tilde{T} > 0$, we have

$$\mathbb{P}_\mu \left(\sup_{A \in \mathbb{N}} \tau_{A,k} < \tilde{T} \right) \leq \frac{\sup_{t \in [0, \tilde{T}]} \mathbb{E} \left(\langle |\text{id}|^k, X_{t \wedge \tilde{T} \wedge \tau_{A,k}} \rangle \right)}{A}$$

which tends to 0 when $A \rightarrow +\infty$. We deduce by FATOU's lemma, when $A \rightarrow +\infty$, the first announced result.

Step 2. Proof of (1)(b). Let $\alpha > 0$. From the martingale problem (2), we deduce that

$$\begin{aligned} \mathbb{P}_\mu \left(\sup_{t \in [0, T \wedge \tau_{A,k}]} \langle h_n^k, X_t \rangle \geq \alpha \right) &\leq \mathbb{P}_\mu \left(\langle h_n^k, X_0 \rangle \geq \frac{\alpha}{5} \right) + \mathbb{P}_\mu \left(\int_0^{T \wedge \tau_{A,k}} \left\langle \frac{(h_n^k)''}{2}, X_s \right\rangle ds \geq \frac{\alpha}{5} \right) \\ &\quad + \mathbb{P}_\mu \left(\gamma \int_0^{T \wedge \tau_{A,k}} \left\langle (h_n^k)''', X_s \right\rangle M_2(X_s) ds \geq \frac{\alpha}{5} \right) \\ &\quad + \mathbb{P}_\mu \left(2\gamma \int_0^{T \wedge \tau_{A,k}} \left\langle (h_n^k)' \times \text{id}, X_s \right\rangle M_2(X_s) ds \geq \frac{\alpha}{5} \right) \\ &\quad + \mathbb{P}_\mu \left(\sup_{t \in [0, T \wedge \tau_{A,k}]} \left| \widehat{M}_t^{\text{id}}(h_n^k) \right| \geq \frac{\alpha}{5} \right) \end{aligned}$$

The DOOB maximal inequality allows us to write

$$\mathbb{P}_\mu \left(\sup_{t \in [0, T \wedge \tau_{A,k}]} \left| \widehat{M}_t^{\text{id}}(h_n^k) \right| \geq \frac{\alpha}{5} \right) \leq \frac{5\mathbb{E} \left(\left(\widehat{M}_{T \wedge \tau_{A,k}}^{\text{id}}(h_n^k) \right)_+ \right)}{\alpha}.$$

From the martingale problem (2) and the computations of Step 1, we deduce that

$$\begin{aligned} \mathbb{E} \left(\left| \widehat{M}_{T \wedge \tau_{A,k}}^{\text{id}}(h_n^k) \right| \right) &\leq 2\mathbb{E} \left(\langle h^k, X_0 \rangle \right) + 2C_1(k)\mathbb{E} \left(\int_0^{T \wedge \tau_{A,k}} \langle h^k, X_s \rangle ds \right) + 2C_2(k, A) \|g_n''\|_\infty \\ &\leq 2\mathbb{E} \left(\langle h^k, X_0 \rangle \right) [1 + \exp(C_1(k)T)] + 2C_2(k, A) \|g_n''\|_\infty, \end{aligned}$$

where we use the FUBINI-TONELLI theorem and the relation (21). It follows, from MARKOV's inequality, that there exists a constant $C_k > 0$ such that

$$\mathbb{P}_\mu \left(\sup_{t \in [0, T \wedge \tau_{A,k}]} \langle h_n^k, X_t \rangle \geq \alpha \right) \leq \frac{C_k}{\alpha} \left[\mathbb{E} \left(\langle h^k, X_0 \rangle \right) [1 + \exp(C_1(k)T)] + C_2(k, A) \|g_n''\|_\infty \right].$$

By applying the dominated convergence theorem twice, successively when $n \rightarrow +\infty$ then when $A \rightarrow +\infty$, there exists a constant $\widetilde{C}_{k,T} > 0$ such that

$$\mathbb{P}_\mu \left(\sup_{t \in [0, T]} \langle h^k, X_t \rangle \geq \alpha \right) \leq \frac{\widetilde{C}_{k,T} \mathbb{E}(\langle h^k, X_0 \rangle)}{\alpha},$$

and thus the announced result.

Step 3. $\widehat{M}^{\text{id}}(\text{id}^k)$ is a continuous local martingale. From the properties of $(g_n)_{n \in \mathbb{N}}$, note that there exists a constant $\widehat{C}_k > 0$ such that for all $n \in \mathbb{N}$, $|g_n^k| \leq |\text{id}^k$ and $|(g_n^k)''| \leq \widehat{C}_k (1 + |\text{id}^{k-1})$. It follows from the martingale problem (2), the properties of $(g_n)_{n \in \mathbb{N}}$ and the dominated convergence theorem for conditional expectation that

$$\begin{aligned} \widehat{M}_{t \wedge \tau_{A,2}}^{\text{id}}(\text{id}^k) &:= \lim_{n \rightarrow +\infty} \widehat{M}_{t \wedge \tau_{A,2}}^{\text{id}}(g_n^k) \\ &= \langle \text{id}^k, X_{t \wedge \tau_{A,2}} \rangle - \langle \text{id}^k, X_0 \rangle - \int_0^{t \wedge \tau_{A,2}} \frac{k(k-1)}{2} \langle \text{id}^{k-2}, X_s \rangle ds \\ &\quad - \gamma \int_0^{t \wedge \tau_{A,2}} \left[k(k-1) \langle \text{id}^{k-2}, X_s \rangle M_2(X_s) - 2k \langle \text{id}^k, X_s \rangle \right] ds \end{aligned}$$

is a continuous \mathbb{P}_μ -martingale and thus $(\widehat{M}^{\text{id}}(\text{id}^k))_{0 \leq t \leq T}$ is a continuous \mathbb{P}_μ -local martingale. When $\mathbb{E}(\langle |\text{id}^{k+1}, \mu \rangle) < \infty$, using the inequality for all $t \in [0, T]$,

$$\langle |\text{id}^{k-1}, X_t \rangle \langle \text{id}^2, X_t \rangle \leq \langle |\text{id}^{k+1}, X_t \rangle,$$

the same computation applies replacing $t \wedge \tau_{A,2}$ by t to obtain that $(\widehat{M}^{\text{id}}(\text{id}^k))_{0 \leq t \leq T}$ is a continuous \mathbb{P}_μ -martingale.

Step 4. L^2 -martingale and quadratic variation. As soon as $\mathbb{E}(\langle |\text{id}^{k+1}, \mu \rangle) < \infty$, $\widehat{M}^{\text{id}}(\text{id}^k) \in L^2(\widetilde{\Omega})$ as a straightforward consequence of HÖLDER's inequality. It follows from (3) that for all $n \in \mathbb{N}$, for all $t \in [0, T]$,

$$\begin{aligned} \langle \widehat{M}^{\text{id}}(g_n^k) \rangle_t &= 2\gamma \int_0^t \left(\langle g_n^{2k}, X_s \rangle - \langle g_n^k, X_s \rangle^2 + \langle (g_n^k)', X_s \rangle^2 M_2(X_s) \right. \\ &\quad \left. - 2 \langle (g_n^k)', X_s \rangle \langle g_n^k \times \text{id}, X_s \rangle \right) ds. \end{aligned}$$

For all $n \in \mathbb{N}$, the process

$$N_{t,n} := \left[\widehat{M}_t^{\text{id}}(g_n^k) \right]^2 - \langle \widehat{M}^{\text{id}}(g_n^k) \rangle_t$$

is a \mathbb{P}_μ -local martingale. As $\widehat{M}^{\text{id}}(\text{id}^k)$ is bounded on $[0, T \wedge \tau_{A,2k}]$ for all $A \in \mathbb{N}$, then for all $n \in \mathbb{N}$, $(N_{t \wedge \tau_{A,2k}, n})$ is a martingale. From the relation (20) with $2k$, the dominated convergence

theorem for conditional expectation implies as above that \mathbb{P}_μ -a.s.

$$\begin{aligned} \lim_{n \rightarrow +\infty} N_{t \wedge \tau_{A,2k},n} &= \left[\widehat{M}_{t \wedge \tau_{A,2k}}^{\text{id}}(\text{id}^k) \right]^2 - 2\gamma \int_0^{t \wedge \tau_{A,2k}} \left(\langle \text{id}^{2k}, X_s \rangle - \langle \text{id}^k, X_s \rangle^2 \right. \\ &\quad \left. + k \langle \text{id}^{k-1}, X_s \rangle^2 M_2(X_s) - 2k \langle \text{id}^{k-1}, X_s \rangle \langle \text{id}^{k+1}, X_s \rangle \right) ds \end{aligned}$$

is a \mathbb{P}_μ -martingale and we deduce the quadratic variation announced. \square

2.4.3 Compact support

Proposition 2.12. *For all $\mu \in \mathcal{M}_1^{c,2}(\mathbb{R})$, for all $\varepsilon > 0$, $\bigcup_{\varepsilon \leq s \leq t} \text{Supp} Z_s$ is compact \mathbb{P}_μ -a.s. where $\text{Supp} Z_s$ is the support of Z_s . Further, if $\text{Supp} Z_0$ is compact, then $\overline{\bigcup_{0 \leq s \leq t} \text{Supp} Z_s}$ is compact for all $t > 0$, \mathbb{P}_μ -a.s.*

Proof. It is proved in [36] that the support of the Λ -FLEMING-VIOT process associated to a Λ -coalescent which comes down from infinity, is compact at all positive times. Our case corresponds to KINGMAN's coalescent. In addition, they prove that, given that the initial condition ν has compact support,

$$\overline{\bigcup_{0 \leq s < t} \text{Supp} Y_s}$$

is compact for all $t > 0$, \mathbb{P}_ν^{FV} -a.s. MARKOV's property then entails that, if $\nu \in \mathcal{M}_1^{c,2}(\mathbb{R})$, $\bigcup_{\varepsilon \leq s \leq t} \text{Supp} Y_s$ is compact for all $0 < \varepsilon < t$, \mathbb{P}_ν^{FV} -a.s. Hence, the same is true for $Z_t = \tau_{-(\text{id}, Y_t)} \# Y_t$. \square

3 Uniqueness for the centered Fleming-Viot process

As for the original FLEMING-VIOT martingale problem, we will prove uniqueness to the martingale problem (2) by relying on the *duality method* [17, 8, 20, 22]. Additional difficulties occur in our case since bounds on the dual process are much harder to obtain and the duality identity cannot be proved in its usual form. In particular, we can prove uniqueness only for initial conditions admitting finite moments.

3.1 Main result

Theorem 3.1. *The centered FLEMING-VIOT martingale problem (2) has an unique solution if the initial condition has all its moments finite.*

The reason why we need to assume finite initial moment will be explained at the end of Subsection 3.2. In particular, we will see in Remark 6.5 that we cannot hope to prove uniqueness for more general initial conditions using our duality method.

Corollary 3.2. *Existence and uniqueness hold for all the martingale problems of Definitions 2.1, 2.5 and 2.8 and they all admit the same solution if the initial condition has all its moments finite.*

Proof of Corollary 3.2. We proved in Subsection 2.3 that \mathbb{P}_μ solves the martingale problems of Definitions 2.5 and 2.8. Since a solution to these martingale problems is of course also solution to Definition 2.1, uniqueness for Definition 2.1 implies uniqueness for the other martingale problems. \square

3.2 Notations and outline of the uniqueness proof

Our proof of Theorem 3.1 is based on the *duality method* as proposed in [20, 22]. We denote, for all $n \in \mathbb{N}^*$, $\mu \in \mathcal{M}_1(\mathbb{R})$ and $f \in \mathcal{C}_b^2(\mathbb{R}^n, \mathbb{R})$

$$F(f, \mu) := \langle f, \mu^n \rangle = \int_{\mathbb{R}} \cdots \int_{\mathbb{R}} f(x_1, \dots, x_n) \mu(dx_1) \cdots \mu(dx_n).$$

From (16), the operator \mathcal{L}_{FVc} applied on the function $\mu \mapsto F(f, \mu)$ with fixed f , satisfies the following identity:

$$\begin{aligned} \mathcal{L}_{FVc} F(f, \mu) &= \langle B^{(n)} f, \mu^n \rangle + \gamma \sum_{i=1}^n \sum_{\substack{j=1 \\ j \neq i}}^n [\langle \Phi_{i,j} f, \mu^{n-1} \rangle - \langle f, \mu^n \rangle] \\ &\quad + \gamma \sum_{i=1}^n \sum_{j=1}^n [\langle K_{i,j} f, \mu^{n+1} \rangle - \langle f, \mu^n \rangle] + \gamma n^2 \langle f, \mu^n \rangle \\ &=: \tilde{\mathcal{L}}_f^* F(f, \mu) + \gamma n^2 \langle f, \mu^n \rangle \end{aligned} \tag{22}$$

We note that $\tilde{\mathcal{L}}_f^*$ can be seen as an operator acting on the function $f \mapsto F(f, \mu)$ with fixed μ . The operator $\tilde{\mathcal{L}}_f^*$ can be interpreted as the generator of a stochastic process on the state space $\bigcup_{n \in \mathbb{N}^*} \mathcal{C}_b^2(\mathbb{R}^n, \mathbb{R})$. Following ETHIER-KURTZ's works [20, 22], this suggests to introduce a dual process $(\xi_t)_{t \geq 0}$, of generator $\tilde{\mathcal{L}}_f^*$ and to prove a duality relation of the form:

$$\forall t \geq 0, \quad \mathbb{E} \left(\langle \xi_0, X_t^{M(0)} \rangle \right) = \mathbb{E} \left(\langle \xi_t, X_0^{M(t)} \rangle \exp \left(\gamma \int_0^t M^2(u) du \right) \right) \tag{23}$$

where $M := (M(t))_{t \geq 0}$ is a MARKOV's jump process in \mathbb{N} whose transition rates are given by:

$$\text{(1)} \quad q_{n,n+1} = \gamma n^2 \quad \text{(2)} \quad q_{n,n-1} = \gamma n(n-1) \quad \text{(3)} \quad q_{i,j} = 0 \text{ otherwise.}$$

It is known that the relation (23) implies uniqueness [25, Theorem 4.4.2]. However in our situation, it is difficult to obtain the strong version (23). For technical reasons, we will obtain only a weakened version. Therefore, the proof will be divided in two large steps.

Step 1. Construction of the dual process $(\xi_t)_{t \geq 0}$. The relation (22) suggests that the dual process $(\xi_t)_{t \geq 0}$ jumps, for all $i, j \in \{1, \dots, n\}$ from $f \in \mathcal{C}_b^2(\mathbb{R}^n, \mathbb{R})$ to $K_{i,j} f \in \mathcal{C}_b^2(\mathbb{R}^{n+1}, \mathbb{R})$ at rate γ and if $i \neq j$, from $f \in \mathcal{C}_b^2(\mathbb{R}^n, \mathbb{R})$ to $\Phi_{i,j} f \in \mathcal{C}_b^2(\mathbb{R}^{n-1}, \mathbb{R})$ at rate γ . Between jumps, this dual process evolves according to the semi-group of operator $(T^{(n)}(t))_{t \geq 0}$ associated to the generator $B^{(n)}$ given by (14). We will give an explicit expression of the semi-group $(T^{(n)}(t))_{t \geq 0}$ defined as an integral against Gaussian kernels. This representation will be derived from a probabilistic interpretation of the semi-group using a FEYNMAN-KAC's formula. We define the dual process as follows:

Definition 3.3. For all $M(0) \in \mathbb{N}^*$, for all $\xi_0 \in \mathcal{C}_b^2(\mathbb{R}^{M(0)}, \mathbb{R})$,

$$\xi_t := T^{(M(\tau_n))} (t - \tau_n) \Gamma_n T^{(M(\tau_{n-1}))} (\tau_n - \tau_{n-1}) \Gamma_{n-1} \cdots \Gamma_1 T^{(M(0))} (\tau_1) \xi_0, \quad \tau_n \leq t < \tau_{n+1}, \quad n \in \mathbb{N}, \quad (24)$$

where $(\tau_n)_{n \in \mathbb{N}}$ is the sequence of jump times of the birth-death process M with $\tau_0 = 0$ and where $(\Gamma_n)_{n \in \mathbb{N}}$ is a sequence of random operators. These are conditionally independent given M and satisfy for all $k \in \mathbb{N}$, $n \geq 1$ and $1 \leq i \neq j \leq n$,

$$\mathbb{P} \left(\Gamma_k = \Phi_{i,j} \mid \{M(\tau_k^-) = n, M(\tau_k) = n - 1\} \right) = \frac{1}{n(n-1)} \quad (25)$$

and for all $n \geq 1$ and $1 \leq i, j \leq n$,

$$\mathbb{P} \left(\Gamma_k = K_{i,j} \mid \{M(\tau_k^-) = n, M(\tau_k) = n + 1\} \right) = \frac{1}{n^2}. \quad (26)$$

Moreover, the random times $(\tau_k - \tau_{k-1})_{k \geq 1}$ are independent conditionally to $M(\tau_{k-1}) = n$ and of exponential law of parameter $\gamma n^2 + \gamma n(n-1)$.

Note that M is a non-explosive process:

$$\forall T > 0, \quad \mathbb{P} \left(\sup_{t \in [0, T]} M(t) < +\infty \right) = \mathbb{P} \left(\lim_{n \rightarrow +\infty} \tau_n = +\infty \right) = 1. \quad (27)$$

Indeed, we note that for the choice of $\mu_i := \gamma i(i-1)$ and $\lambda_i := \gamma i^2$, $i \geq 1$ in [1, Theorem 2.2.], we have

$$\frac{\mu_i \cdots \mu_2}{\lambda_i \cdots \lambda_2 \lambda_1} = \frac{1}{2\gamma i} > 0,$$

so that

$$\sum_{i \geq 1} \left(\frac{1}{\lambda_i} + \frac{\mu_i}{\lambda_i \lambda_{i-1}} + \cdots + \frac{\mu_i \cdots \mu_2}{\lambda_i \cdots \lambda_2 \lambda_1} \right) \geq \sum_{i \geq 1} \frac{\mu_i \cdots \mu_2}{\lambda_i \cdots \lambda_2 \lambda_1} = +\infty.$$

Hence, M is non-explosive.

Step 2. Weakened duality relation. We consider fixed $M(0) \in \mathbb{N}^*$, $\xi_0 \in \mathcal{C}_b^2(\mathbb{R}^{M(0)}, \mathbb{R})$ and $(X_t)_{t \geq 0}$ a stochastic process whose law \mathbb{P}_μ is a solution of the martingale problem (2) with $\mu \in \mathcal{M}_1^{c,2}(\mathbb{R})$. We introduce a dual process $(\xi_t)_{t \geq 0}$ independent of $(X_t)_{t \geq 0}$ built on the same probability space (enlarging it if necessary). We shall denote by $\mathbb{P}_{(\mu, \xi_0)}$, the law of $((X_t, \xi_t))_{t \geq 0}$ on this probability space. For any $k \in \mathbb{N}$, we introduce the stopping time

$$\theta_k := \inf \left\{ t \geq 0 \mid M(t) \geq k \quad \text{or} \quad \exists s \in [0, t], \langle \xi_s, X_{t-s}^{M(s)} \rangle \geq k \right\}. \quad (28)$$

Theorem 3.4. Given any $(X_t)_{t \geq 0}$ $(\xi_t)_{t \geq 0}$ as above, we have the weakened duality identity: for all $k \in \mathbb{N}$ and any stopping time θ such that $\theta \leq \theta_k$,

$$\forall t \geq 0, \quad \mathbb{E}_{(\mu, \xi_0)} \left(\langle \xi_0, X_{t \wedge \theta}^{M(0)} \rangle \right) = \mathbb{E}_{(\mu, \xi_0)} \left(\langle \xi_{t \wedge \theta}, X_0^{M(t \wedge \theta)} \rangle \exp \left(\gamma \int_0^{t \wedge \theta} M^2(u) du \right) \right). \quad (29)$$

Note that this result holds true for any initial measure $\mu \in \mathcal{M}_1^{c,2}(\mathbb{R})$. The stopping time θ_k ensures that each of the quantities involved in (29) are bounded and thus that their expectations are finite. Afterwards, we want to prove that if two solutions of the martingale problem satisfy the weakened duality identity, then their 1–dimensional marginals coincide. This is where we need stronger assumptions on μ .

Lemma 3.5. *Assume that $\mu \in \mathcal{M}_1^{c,2}(\mathbb{R})$ has all its moments finite. Then, the stopping time θ_k defined by (28) satisfies $\lim_{k \rightarrow +\infty} \theta_k = +\infty$, $\mathbb{P}_{(\mu, \xi_0)}$ – a.s.*

We will see in Remark 6.5 that the assumption on μ is optimal in the following sense: even if ξ_0 is bounded, ξ_t may have polynomial growth of any exponent k in some direction of $\mathbb{R}^{M(t)}$ so that $\langle |\xi_t|, \mu^{M(t)} \rangle$ is infinite if μ has infinite k^{th} moment. This shows that we cannot expect to have $\theta_k \rightarrow +\infty$ when $k \rightarrow +\infty$ if μ has not all its moments finite. This means that we cannot expect that the duality method could give uniqueness for weaker assumptions on the initial condition.

The proofs of Theorem 3.4 and Lemma 3.5 are respectively given in Subsections 6.2 and 6.3. Once they are proved, the proof of uniqueness can be completed as follows.

3.3 Proof of Theorem 3.1 from Theorem 3.4 and Lemma 3.5

We rely on Theorem 4.4.2 of the ETHIER-KURTZ book [25]. To get the desired result, i.e. the uniqueness of the martingale problem (2), it is sufficient to verify that if we give ourselves two solutions to the martingale problem (2), they have the same 1–dimensional marginal laws.

Let $(X_t)_{t \geq 0}$ and $(\tilde{X}_t)_{t \geq 0}$ be two solutions of the martingale problem (2) with the same initial condition $\mu \in \mathcal{M}_1^{c,2}(\mathbb{R})$ which has all its moments finite. Let $(\xi_t)_{t \geq 0}$ be the dual process with initial condition $\xi_0 \in \mathcal{C}_b^2(\mathbb{R}^{M(0)}, \mathbb{R})$ with $M(0) \in \mathbb{N}$. We suppose that these three processes are built on the same probability space and independent of each other. We denote by

$$\tilde{\theta}_k := \inf \left\{ t \geq 0 \mid M(t) \geq k \quad \text{or} \quad \exists s \in [0, t], \langle \xi_s, \tilde{X}_{t-s}^{M(s)} \rangle \geq k \right\}.$$

These processes satisfy, the weakened duality identity (29):

$$\begin{aligned} \forall t \geq 0, \quad & \mathbb{E}_{(\mu, \xi_0)} \left(\left\langle \xi_0, X_{t \wedge \theta_k \wedge \tilde{\theta}_k}^{M(0)} \right\rangle \right) \\ &= \mathbb{E}_{(\mu, \xi_0)} \left(\left\langle \xi_{t \wedge \theta_k \wedge \tilde{\theta}_k}, \mu^{M(t \wedge \theta_k \wedge \tilde{\theta}_k)} \right\rangle \exp \left(\gamma \int_0^{t \wedge \theta_k \wedge \tilde{\theta}_k} M^2(u) du \right) \right) \\ &= \mathbb{E}_{(\mu, \xi_0)} \left(\left\langle \xi_0, \tilde{X}_{t \wedge \theta_k \wedge \tilde{\theta}_k}^{M(0)} \right\rangle \right). \end{aligned}$$

In particular, for the choice $M(0) := 1$, for all $k \in \mathbb{N}$ and for all $\xi_0 \in \mathcal{C}_b^2(\mathbb{R}, \mathbb{R})$, we obtain

$$\forall t \geq 0, \quad \mathbb{E}_{(\mu, \xi_0)} \left(\left\langle \xi_0, X_{t \wedge \theta_k \wedge \tilde{\theta}_k} \right\rangle \right) = \mathbb{E}_{(\mu, \xi_0)} \left(\left\langle \xi_0, \tilde{X}_{t \wedge \theta_k \wedge \tilde{\theta}_k} \right\rangle \right).$$

From Lemma 3.5, since X_t and \tilde{X}_t have continuous paths for the topology of weak convergence, we have $\mathbb{P}_{(\mu, \xi_0)}$ –a.s.,

$$\lim_{k \rightarrow +\infty} \left\langle \xi_0, X_{t \wedge \theta_k \wedge \tilde{\theta}_k} \right\rangle = \langle \xi_0, X_t \rangle \quad \text{and} \quad \lim_{k \rightarrow +\infty} \left\langle \xi_0, \tilde{X}_{t \wedge \theta_k \wedge \tilde{\theta}_k} \right\rangle = \langle \xi_0, \tilde{X}_t \rangle.$$

Therefore, we deduce from the dominated convergence theorem, that for all $\xi_0 \in \mathcal{C}_b^2(\mathbb{R}, \mathbb{R})$,

$$\forall t \geq 0, \quad \mathbb{E}_{(\mu, \xi_0)}(\langle \xi_0, X_t \rangle) = \mathbb{E}_{(\mu, \xi_0)}(\langle \xi_0, \tilde{X}_t \rangle).$$

As $\left\{ \langle f, \cdot \rangle \mid f \in \mathcal{C}_b^2(\mathbb{R}, \mathbb{R}) \right\}$ is a $\mathcal{M}_1(\tilde{\Omega})$ -determining class [29, Definition 4.24], it follows that for any $t \geq 0$, X_t and \tilde{X}_t have the same law. Theorem 4.4.2 of [25] then ensures uniqueness to the martingale problem (2). \square

4 Ergodicity for the centered Fleming-Viot process

In this section, we establish ergodicity properties with exponential convergence in total variation for the centered FLEMING-VIOT process $(Z_t)_{t \geq 0}$. For all $\mu, \nu \in \mathcal{M}_1(\mathbb{R})$, we denote by

$$\|\mu - \nu\|_{TV} := \frac{1}{2} \sup_{\|f\|_\infty \leq 1} |\langle f, \mu \rangle - \langle f, \nu \rangle|,$$

the total variation distance between μ and ν .

Theorem 4.1. *There exists a unique invariant probability measure π for $(Z_t)_{t \geq 0}$ and constants $\alpha, \beta \in (0, +\infty)$ such that for all $\mu \in \mathcal{M}_1^{c,2}(\mathbb{R})$, for all $T \geq 0$,*

$$\|\mathbb{P}_\mu(Z_T \in \cdot) - \pi\|_{TV} \leq \alpha \exp(-\beta T).$$

The main part of this section is devoted to the proof of this result (Subsections 4.1 to 4.5) and in Subsection 4.6, we characterise the invariant measure of the centered FLEMING-VIOT process. In Subsection 4.1 we construct the centered MORAN process and we establish its convergence in law to the centered FLEMING-VIOT process. In Subsections 4.2 and 4.3, we construct, backward in time, the MORAN process, its centered version and we exploit its relationship with the KINGMAN coalescent in order to prove in Subsection 4.4 an exponential coupling in total variation for the MORAN process. We finally deduce, in Subsection 4.5, the proof of the main result announced by letting the number of particles go to infinity.

4.1 Moran's models and Fleming-Viot's processes

In [16, 9, 26, 8], the authors construct the original FLEMING-VIOT process as a scaling limit of a particle process: the MORAN process. The aim of this subsection is to construct the version of the centered MORAN process and to establish its convergence in law to the centered FLEMING-VIOT process.

We consider the MORAN particle process Y^N defined by

$$Y_t^N := \frac{1}{N} \sum_{i=1}^N \delta_{X_i(t)}$$

with state space $\mathcal{M}_{1,N}(\mathbb{R})$, the set of probability measures on \mathbb{R} consisting of N atoms of mass $1/N$. Moreover, if $(X_i(0))_{i \in \mathbb{N}^*}$ is exchangeable, then for all $t > 0$, $(X_i(t))_{i \in \mathbb{N}^*}$ is exchangeable [22, Theorem 6.1]. The infinitesimal generator of the \mathbb{R} -measure-valued process Y^N is given for all $F \in \mathcal{C}^2(\mathbb{R}, \mathbb{R})$, $g \in \mathcal{C}_b^2(\mathbb{R}, \mathbb{R})$, for all $\mu_N \in \mathcal{M}_{1,N}(\mathbb{R})$ by

$$L_N F(\langle g, \mu_N \rangle) = F\left(\left\langle \frac{1}{2} \Delta g, \mu_N \right\rangle\right) + \gamma \frac{N(N-1)}{2} \int_{\mathbb{R}} \int_{\mathbb{R}} \left[F\left(\langle g, \mu_N \rangle - \frac{g(x)}{N} + \frac{g(y)}{N}\right) - F(\langle g, \mu_N \rangle) \right] \mu_N(dx) \mu_N(dy).$$

The first term of the generator describes the effect of the mutation according to the LAPLACIAN operator. The second term describes the sampling replacement mechanism: at rate γ (the sampling rate) an individual of type x is immediately replaced by one of type y . Note that the population size remains constant over time.

We recall the following convergence result [8, Theorem 2.7.1]: for all initial condition $Y_0^N = \frac{1}{N} \sum_{i=1}^N \delta_{X_i} \in \mathcal{M}_{1,N}(\mathbb{R})$ with $(X_i)_{1 \leq i \leq N}$ exchangeable \mathbb{R} -valued random variables such that Y_0^N converges in law to $\mu \in \mathcal{M}_1(\mathbb{R})$ as $N \rightarrow +\infty$, the MORAN process $(Y_t^N)_{t \geq 0}$ converges in law on $\mathcal{C}^0([0, +\infty), \mathcal{M}_1(\mathbb{R}))$, as $N \rightarrow +\infty$, to the original FLEMING-VIOT process $(Y_t)_{t \geq 0}$ defined as the solution to the martingale problem (4).

We denote $\mathcal{M}_{1,N}^{c,2}(\mathbb{R}) := \left\{ \mu_N \in \mathcal{M}_{1,N}(\mathbb{R}) \mid \langle \text{id}^2, \mu_N \rangle < \infty, \langle \text{id}, \mu_N \rangle = 0 \right\}$, and we define the centered MORAN process $(Z_t^N)_{t \geq 0}$ by

$$Z_t^N := \tau_{-\langle \text{id}, Y_t^N \rangle} \# Y_t^N, \quad t \geq 0.$$

The main result of this subsection is the following:

Proposition 4.2. *For all initial condition $Z_0^N := \frac{1}{N} \sum_{i=1}^N \delta_{X_i} \in \mathcal{M}_{1,N}^{c,2}(\mathbb{R})$ with $(X_i)_{1 \leq i \leq N}$ exchangeable \mathbb{R} -valued random variables such that Z_0^N converges in law to $Z_0 \in \mathcal{M}_1^{c,2}(\mathbb{R})$ as $N \rightarrow +\infty$ and satisfying $\sup_{N \in \mathbb{N}} \mathbb{E}(\langle \text{id}^2, Z_0^N \rangle) < \infty$, the centered MORAN process $(Z_t^N)_{t \geq 0}$ converges in law on $\mathcal{C}^0([0, +\infty), \mathcal{M}_1^{c,2}(\mathbb{R}))$, as $N \rightarrow +\infty$, to the centered FLEMING-VIOT process $(Z_t)_{t \geq 0}$ solution of the martingale problem (2) with initial condition Z_0 .*

A difficulty in proving this result lies in the fact that $\mu \mapsto \tau_{-\langle \text{id}, \mu \rangle} \# \mu$ may not be continuous on $\mathcal{M}_1(\mathbb{R})$ because id is not bounded. Hence we need to carry out several approximations and be very careful to control the approximation error on events of large probabilities. In order to prove this proposition, we need to introduce some notations and results. For all real-valued function f on \mathbb{R} , the LIPSCHITZ seminorm is defined by $\|f\|_L = \sup_{x \neq y} \frac{|f(x) - f(y)|}{|x - y|}$. We denote by

$$BL_1(\mathbb{R}) := \left\{ f : \mathbb{R} \rightarrow \mathbb{R} \mid \|f\|_{BL} \leq 1 \right\}$$

where $\|f\|_{BL} := \|f\|_L + \|f\|_\infty$. For all $\mu, \nu \in \mathcal{M}_1(\mathbb{R})$, we denote by

$$d_{FM}(\mu, \nu) := \sup_{f \in BL_1(\mathbb{R})} |\langle f, \mu \rangle - \langle f, \nu \rangle|,$$

the FORTET-MOURIER distance. Recall that $\mathcal{M}_1(\mathbb{R})$ endowed with the weak topology is complete for the distance of FORTET-MOURIER [15, Corollary 11.5.5]. Let Λ denote the class of strictly increasing, continuous mappings of $[0, T]$ onto itself. For given metric spaces E and \widetilde{E} , we denote by $\mathbb{D}([0, T], E)$, the space of right continuous and left limited (càd-làg) functions from $[0, T]$ to E and by $\mathcal{C}_b^0(E, \widetilde{E})$ the space of continuous bounded functions from E to \widetilde{E} . For $x, y \in \mathbb{D}([0, T], \mathcal{M}_1(\mathbb{R}))$, we define the distance $d_0(x, y)$ by:

$$d_0(x, y) := \inf_{\lambda \in \Lambda} \left\{ \sup_{t \in [0, T]} d_{FM}(x \circ \lambda(t), y(t)) + \sup_{s < t} \left| \log \left(\frac{\lambda(t) - \lambda(s)}{t - s} \right) \right| \right\}.$$

From [2, Theorem 12.2 and Remark of page 121], $(\mathbb{D}([0, T], \mathcal{M}_1(\mathbb{R})), d_0)$ is a Polish space and the topology induced by the distance d_0 is the SKOROHOD topology. Let us consider the following lemma whose proof is similar to that of Proposition 2.11 and left to the reader:

Lemma 4.3. *Let $T > 0$ and $k \in \mathbb{N}$ fixed. There exists a constant $C_{k, T} > 0$ independent of N such that for all $Y_0^N \in \mathcal{M}_{1, N}(\mathbb{R})$ satisfying $\sup_{N \in \mathbb{N}} \mathbb{E}(\langle |\text{id}|^k, Y_0^N \rangle) < \infty$, the MORAN process $(Y_t^N)_{0 \leq t \leq T}$ satisfies*

$$\forall \alpha > 0, \quad \mathbb{P}_{Y_0^N} \left(\sup_{t \in [0, T]} \langle |\text{id}|^k, Y_t^N \rangle \geq \alpha \right) \leq \frac{C_{k, T} \sup_{N \in \mathbb{N}} \mathbb{E}(\langle |\text{id}|^k, Y_0^N \rangle)}{\alpha}.$$

Proof of Proposition 4.2. We want to establish that for all $g \in \mathcal{C}_b^0(\mathbb{D}([0, T], \mathcal{M}_1(\mathbb{R})), \mathbb{R})$, $\lim_{N \rightarrow +\infty} \mathbb{E}(g(Z^N)) = \mathbb{E}(g(Z))$. Let $\varepsilon > 0$. We consider the two following maps F and F_ε from $\mathbb{D}([0, T], \mathcal{M}_1^1(\mathbb{R}))$ to $\mathbb{D}([0, T], \mathcal{M}_1(\mathbb{R}))$ defined by $F(y)(t) := \tau_{-(\text{id}, y(t))} \# y(t)$ and $F_\varepsilon(y)(t) := \tau_{-(h_\varepsilon, y(t))} \# y(t)$ where h_ε is a map from \mathbb{R} to \mathbb{R} defined by

$$h_\varepsilon(x) := \begin{cases} x & \text{if } |x| \leq \frac{1}{\varepsilon} \\ \frac{1}{\varepsilon} & \text{if } x > \frac{1}{\varepsilon} \\ -\frac{1}{\varepsilon} & \text{if } x < -\frac{1}{\varepsilon} \end{cases}.$$

Step 1. Continuity of F_ε . In this step, we want to establish that

$$F_\varepsilon \in \mathcal{C}_b^0(\mathbb{D}([0, T], \mathcal{M}_1(\mathbb{R})), \mathbb{D}([0, T], \mathcal{M}_1(\mathbb{R}))).$$

To obtain this, it is equivalent to prove that if for all $n \in \mathbb{N}$, $y_n, y \in \mathbb{D}([0, T], \mathcal{M}_1(\mathbb{R}))$ and $\lim_{n \rightarrow +\infty} d_0(y_n, y) = 0$, we have $\lim_{n \rightarrow +\infty} d_0(F_\varepsilon(y_n), F_\varepsilon(y)) = 0$. As, $\lim_{n \rightarrow +\infty} d_0(y_n, y) = 0$, there exists $n_0 \in \mathbb{N}$ such that for all $n \geq n_0$, there exists $\lambda_n \in \Lambda$ satisfying

$$\sup_{t \in [0, T]} d_{FM}(y_n \circ \lambda_n(t), y(t)) + \sup_{s < t} \left| \log \left(\frac{\lambda_n(t) - \lambda_n(s)}{t - s} \right) \right| \leq \frac{\varepsilon^2}{2}. \quad (30)$$

Note that

$$d_0(F_\varepsilon(y_n), F_\varepsilon(y)) \leq \sup_{t \in [0, T]} d_{FM}(F_\varepsilon(y_n)(\lambda_n(t)), F_\varepsilon(y)(t)) + \sup_{s < t} \left| \log \left(\frac{\lambda_n(t) - \lambda_n(s)}{t - s} \right) \right|.$$

Now, for all $t \in [0, T]$,

$$\begin{aligned} d_{FM}(F_\varepsilon(y_n)(\lambda_n(t)), F_\varepsilon(y)(t)) &= \sup_{f \in BL_1(\mathbb{R})} \left| \langle f \circ \tau_{-\langle h_\varepsilon, y_n \circ \lambda_n(t) \rangle}, y_n \circ \lambda_n(t) \rangle - \langle f \circ \tau_{-\langle h_\varepsilon, y(t) \rangle}, y(t) \rangle \right| \\ &\leq \sup_{f \in BL_1(\mathbb{R})} \left| \langle f \circ \tau_{-\langle h_\varepsilon, y_n \circ \lambda_n(t) \rangle}, y_n \circ \lambda_n(t) - y(t) \rangle \right| \\ &\quad + \sup_{f \in BL_1(\mathbb{R})} \left| \langle f \circ \tau_{-\langle h_\varepsilon, y_n \circ \lambda_n(t) \rangle} - f \circ \tau_{-\langle h_\varepsilon, y(t) \rangle}, y(t) \rangle \right|. \end{aligned}$$

On the one hand, as $f \in BL_1(\mathbb{R})$, it follows that $f \circ \tau_{-\langle h_\varepsilon, y_n \circ \lambda_n(t) \rangle} \in BL_1(\mathbb{R})$ and thus

$$\sup_{f \in BL_1(\mathbb{R})} \left| \langle f \circ \tau_{-\langle h_\varepsilon, y_n \circ \lambda_n(t) \rangle}, y_n \circ \lambda_n(t) - y(t) \rangle \right| \leq d_{FM}(y_n \circ \lambda_n(t), y(t)).$$

On the other hand, as f and $\varepsilon h_\varepsilon$ are in $BL_1(\mathbb{R})$, we have

$$\begin{aligned} \left| \langle f \circ \tau_{-\langle h_\varepsilon, y_n \circ \lambda_n(t) \rangle} - f \circ \tau_{-\langle h_\varepsilon, y(t) \rangle}, y(t) \rangle \right| &\leq | - \langle h_\varepsilon, y_n \circ \lambda_n(t) \rangle + \langle h_\varepsilon, y(t) \rangle | \\ &= \frac{1}{\varepsilon} | \langle \varepsilon h_\varepsilon, y_n \circ \lambda_n(t) - y(t) \rangle | \\ &\leq \frac{1}{\varepsilon} d_{FM}(y_n \circ \lambda_n(t), y(t)). \end{aligned}$$

It follows from (30) that,

$$\begin{aligned} d_0(F_\varepsilon(y_n), F_\varepsilon(y)) &\leq \left(1 + \frac{1}{\varepsilon} \right) \sup_{t \in [0, T]} d_{FM}(y_n \circ \lambda_n(t), y(t)) + \sup_{s < t} \left| \log \left(\frac{\lambda_n(t) - \lambda_n(s)}{t - s} \right) \right| \\ &\leq \varepsilon. \end{aligned}$$

Step 2. Control in distance d_0 of the difference between $F(Y^N)$ and $F_\varepsilon(Y^N)$.

We consider the MORAN process $(Y_t^N)_{0 \leq t \leq T}$ started from $Y_0^N = Z_0^N$ and the original FLEMING-VIOT process $(Y_t)_{0 \leq t \leq T}$ started from $Y_0 = Z_0$. In this step, we consider the events

$$\Omega_{\varepsilon, N} := \left\{ \sup_{t \in [0, T]} \langle \text{id}^2, Y_t^N \rangle \leq \frac{2}{\sqrt{\varepsilon}} \right\} \quad \text{and} \quad \Omega_{\varepsilon, \infty} := \left\{ \sup_{t \in [0, T]} \langle \text{id}^2, Y_t \rangle \leq \frac{2}{\sqrt{\varepsilon}} \right\}.$$

As $\sup_{N \in \mathbb{N}} \mathbb{E}(\langle \text{id}^2, Z_0^N \rangle) < \infty$, it follows from Lemma 4.3 (respectively Proposition 2.11), there exists a constant $\tilde{C}_T > 0$, independent of N , such that $\mathbb{P}_{Y_0^N}(\Omega_{\varepsilon, N}) \geq 1 - \tilde{C}_T \sqrt{\varepsilon}$ (respectively $\mathbb{P}_{Y_0}(\Omega_{\varepsilon, \infty}) \geq 1 - \tilde{C}_T \sqrt{\varepsilon}$). Moreover, on $\Omega_{\varepsilon, N}$, for all $t \in [0, T]$,

$$\begin{aligned} d_0(F(Y^N), F_\varepsilon(Y^N)) &\leq \sup_{t \in [0, T]} d_{FM}(F(Y^N)(t), F_\varepsilon(Y^N)(t)) \\ &\leq \sup_{t \in [0, T]} \sup_{f \in BL_1(\mathbb{R})} \left\| f \circ \tau_{-\langle \text{id}, Y_t^N \rangle} - f \circ \tau_{-\langle h_\varepsilon, Y_t^N \rangle} \right\|_\infty \\ &\leq \sup_{t \in [0, T]} \left\| \langle |h_\varepsilon - \text{id}|, Y_t^N \rangle \right\|_\infty \\ &\leq \frac{\varepsilon}{2} \sup_{t \in [0, T]} \left\| \langle \text{id}^2, Y_t^N \rangle \right\|_\infty \\ &\leq \sqrt{\varepsilon}, \end{aligned}$$

where we used the inequality $|h_\varepsilon - \text{id}| \leq \frac{\varepsilon}{2} \text{id}^2$. Similarly on $\Omega_{\varepsilon, \infty}$,

$$d_0(F(Y), F_\varepsilon(Y)) \leq \sqrt{\varepsilon}.$$

Step 3. Conclusion. We want to prove that for all $g \in \mathcal{C}_b^0(\mathbb{D}([0, T], \mathcal{M}_1(\mathbb{R})), \mathbb{R})$, $\lim_{N \rightarrow +\infty} \mathbb{E}(g(Z^N)) = \mathbb{E}(g(Z))$. Thanks to the PORTMANTEAU theorem [2, Theorem 2.1], then it is sufficient to prove this for all g 1-LIPSCHITZ. As $(Y^N)_{N \in \mathbb{N}^*}$ converges in law to Y , we deduce that, for N large enough,

$$\left| \mathbb{E}(g \circ F_\varepsilon(Y^N)) - \mathbb{E}(g \circ F_\varepsilon(Y)) \right| \leq \sqrt{\varepsilon}.$$

Using that g is 1-LIPSCHITZ, and the inequalities of Step 2, it follows that

$$\begin{aligned} \left| \mathbb{E}(g(Z^N)) - \mathbb{E}(g(Z)) \right| &= \left| \mathbb{E}(g \circ F(Y^N)) - \mathbb{E}(g \circ F(Y)) \right| \\ &\leq \left| \mathbb{E}(g \circ F_\varepsilon(Y^N)) - \mathbb{E}(g \circ F_\varepsilon(Y)) \right| \\ &\quad + \left| \mathbb{E}(g \circ F(Y^N)) - \mathbb{E}(g \circ F_\varepsilon(Y^N)) \right| \\ &\quad + \left| \mathbb{E}(g \circ F_\varepsilon(Y)) - \mathbb{E}(g \circ F(Y)) \right| \\ &\leq \sqrt{\varepsilon} + 2 \|g\|_\infty \left[\mathbb{P}_{Y_0^N}(\Omega_{\varepsilon, N}^c) + \mathbb{P}_{Y_0}(\Omega_{\varepsilon, \infty}^c) \right] \\ &\quad + \sqrt{\varepsilon} \left[\mathbb{P}_{Y_0^N}(\Omega_{\varepsilon, N}) + \mathbb{P}_{Y_0}(\Omega_{\varepsilon, \infty}) \right] \\ &\leq (3 + 2 \|g\|_\infty \tilde{C}_T) \sqrt{\varepsilon}. \end{aligned}$$

The announced result follows and completes the proof. \square

4.2 Backward construction of Moran's process and Kingman's coalescent

In this subsection, we exploit the relationship between the MORAN model and the KINGMAN coalescent to obtain in Proposition 4.7, a result of exponential ergodicity in total variation for the centered MORAN model uniform in N . The genealogy of a sample from a population evolving according to the MORAN model of Subsection 4.1 is exactly determined by KINGMAN's coalescent with coalescence rate γ . The state of the population at the final time is constructed from the ancestral positions by following the genealogy and adding mutations on the genealogical tree of the sample according to a standard Brownian motion. Therefore, at the final time T , the position of each individual of the sample is equal to the sum of the position of its ancestor at time 0 and the Brownian mutations steps that occurred during its ancestral branches in the coalescent. We formalize this construction below by giving some notations and illustrations of the latter ones.

Let be fixed the time $T > 0$ and the number of particles $N \in \mathbb{N}^*$. We consider the probability space $(\widehat{\Omega}, \widehat{\mathcal{F}}, \widehat{\mathbb{P}})$ where $\widehat{\Omega} := \mathcal{K}_{N, T} \times \text{Mut}_{N, T}^{2^N - 1} \times \mathcal{A}_N^{\mu_N}$, $\widehat{\mathcal{F}} := \mathcal{F}_{\mathcal{K}_{N, T}} \otimes \mathcal{F}_{\text{Mut}_{N, T}} \otimes \mathcal{F}_{\mathcal{A}_N^{\mu_N}}$ and $\widehat{\mathbb{P}} := \mathbb{K}_{N, T} \otimes \mathcal{L}_{\text{Mut}}^{\otimes 2^N - 1} \otimes \bigotimes_{i=1}^N \text{Ech}_i^{\mu_N}$ with the following notations.

We denote by $\mathcal{K}_{N, T}$ the state space of the KINGMAN N -coalescent with coalescence rate γ on $[0, T]$:

$$\mathcal{K}_{N, T} := \mathbb{D}([0, T], \Pi_N)$$

with Π_N the set of partitions of $\{1, \dots, N\}$. We denote by $\mathbb{K}_{N,T}$ the law of the KINGMAN N -coalescent with coalescence rate γ on $[0, T]$ and $\mathcal{F}_{\mathcal{K}_{N,T}}$ the SKOROHOD σ -field on $\mathcal{K}_{N,T}$. In the following, in order to simplify the names, the precision “at coalescence rate γ ” will be omitted.

We denote by $\mathcal{A}_N^{\mu_N} := \prod_{i=1}^N \mathbb{R}^i$ the state space of the possible ancestral positions in the KINGMAN N -coalescent at date 0. We denote by $\text{Ech}_i^{\mu_N}$ with $\mu_N := \frac{1}{N} \sum_{j=1}^N \delta_{x_j} \in \mathcal{M}_{1,N}(\mathbb{R})$, the law of a i -sample where we select i elements randomly and without replacement in $\{x_1, \dots, x_N\}$ according to μ_N and by $\mathcal{F}_{\mathcal{A}_N^{\mu_N}}$ the BOREL σ -field on $\mathcal{A}_N^{\mu_N}$.

We denote by $\text{Mut}_{N,T}$ the set of Brownian trajectories of $\mathcal{C}^0([0, T], \mathbb{R})$. We denote by \mathcal{L}_{Mut} the law of a 1-standard Brownian motion and $\mathcal{F}_{\text{Mut}_{N,T}}$ the BOREL σ -field on $\text{Mut}_{N,T}$.

Finally, we denote an element $\widehat{\omega}$ of $\widehat{\Omega}$ as:

$$\widehat{\omega} := \left\{ (k_{N,t})_{0 \leq t \leq T}; \left(W^{(B)} \right)_{B \subset \{1, \dots, N\} \setminus \emptyset}; x^{(1)}, \dots, x^{(N)} = \left(x_1^{(N)}, x_2^{(N)}, \dots, x_N^{(N)} \right) \right\}.$$

Note that $(k_{N,t})_{0 \leq t \leq T}$ is an increasing process in $\mathcal{K}_{N,T}$ representing the genealogy. In addition, we denote by $k_{N,T} := \{L_1, \dots, L_n\}$ with $n := |k_{N,T}|$. In other words, KINGMAN’s N -coalescent contains n distinct lineages where L_i is a subset of $\{1, \dots, N\}$ at the final time T . For each individual $i \in \{1, \dots, N\}$, we denote by $a(i) \in \{1, \dots, n\}$, the index such that $i \in L_{a(i)}$. In other words, $L_{a(i)}$ is the ancestral lineage of i . For each individual $i \in \{1, \dots, N\}$, we denote by $B(s, i)$ the block of the partition $k_{N,s}$ at time s and containing the individual i . We denote by $x^{(n)} = (x_1^{(n)}, \dots, x_n^{(n)})$ the ancestral positions at the final time T so that for all $i \in \{1, \dots, N\}$, $x_{a(i)}^{(n)} \in \mathbb{R}$ is the position of the ancestor of the individual i , at time T , in the genealogical tree. Each process $W^{(B)} = (W_t^{(B)})_{0 \leq t \leq T}$ governs the dynamics of mutations occurring on the interval time where $B \subset k_{N,T}$.

Let us recall the link between the MORAN model and the previous stochastic objects. At each reproduction event t_k in the MORAN model, illustrated on Figure 4.1, an ordered pair of individuals (i, j) is sampled uniformly at random from the population: one the two individuals dies and the other reproduces with equal probabilities. In Figure 4.1, we draw an arrow between lines: the arrow $i \rightarrow j$ indicates that i reproduced and j died. We can recover the ancestry of the sample by tracing backwards in time from the right to the left in Figure 4.1 to obtain Figure 4.2. We coalesce any pair of individuals whenever they find a common ancestor which is represented by the bold blue arrows. The other arrows do not modify the genealogical tree. The ancestral positions in Figure 4.1 are given by $(x_i)_{1 \leq i \leq 5}$ where $\mu_5 = \frac{1}{5} \sum_{i=1}^5 \delta_{x_i}$ and the ancestral positions in Figure 4.2 are distributed as $x^{(2)}$. Note that $x_{a(1)}^{(2)} = x_{a(2)}^{(2)} = x_{a(4)}^{(2)} = x_1^{(2)} = x_1$ and $x_{a(1)}^{(2)} = x_{a(1)}^{(2)} = x_2^{(2)} = x_5$. Then, we add the mutations, denoted by “”. Not all of them are shown in Figures 4.1 and 4.2 for the sake of clarity: the ones which are represented are $w_1 := W_{T-t_6}^{\{\{3\}\}} - W_0^{\{\{3\}\}}$, $w_2 := W_{T-t_4}^{\{\{2\}\}} - W_0^{\{\{2\}\}}$, $w_3 := W_{T-t_3}^{\{\{1,2\}\}} - W_{T-t_4}^{\{\{1,2\}\}}$ and $w_4 := W_T^{\{\{1,2,4\}\}} - W_{T-t_3}^{\{\{1,2,4\}\}}$. Then the position u_i of the individual $i \in \{1, \dots, 5\}$ at time T

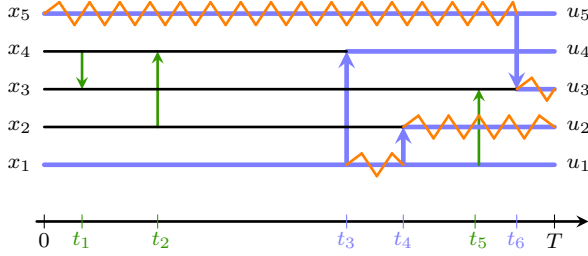

Figure 4.1: Graphical representation of the MORAN model with $N = 5$.

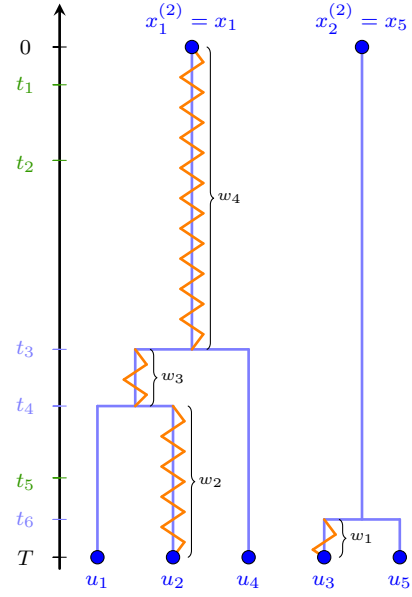

Figure 4.2: KINGMAN's genealogy $(k_{5,T-t})_{0 \leq t \leq T}$ under the MORAN model on the left, tracing back from time T to time 0.

in Figure 4.2, are

$$\begin{aligned}
 u_1 &= x_1 + W_T^{\{\{1,2,4\}\}} - W_{T-t_3}^{\{\{1,2,4\}\}} + W_{T-t_3}^{\{\{1,2\}\}} - W_{T-t_4}^{\{\{1,2\}\}} + W_{T-t_4}^{\{\{1\}\}} - W_0^{\{\{1\}\}}, \\
 u_2 &= x_1 + W_T^{\{\{1,2,4\}\}} - W_{T-t_3}^{\{\{1,2,4\}\}} + W_{T-t_3}^{\{\{1,2\}\}} - W_{T-t_4}^{\{\{1,2\}\}} + W_{T-t_4}^{\{\{2\}\}} - W_0^{\{\{2\}\}}, \\
 u_3 &= x_2 + W_T^{\{\{3,5\}\}} - W_{T-t_6}^{\{\{3,5\}\}} + W_{T-t_6}^{\{\{3\}\}} - W_0^{\{\{3\}\}}, \\
 u_4 &= x_1 + W_T^{\{\{1,2,4\}\}} - W_{T-t_3}^{\{\{1,2,4\}\}} + W_{T-t_3}^{\{\{4\}\}} - W_0^{\{\{4\}\}}, \\
 u_5 &= x_2 + W_T^{\{\{3,5\}\}} - W_{T-t_6}^{\{\{3,5\}\}} + W_{T-t_6}^{\{\{5\}\}} - W_0^{\{\{5\}\}}.
 \end{aligned}$$

Putting everything together, we define in the general case the random variable

$$\widehat{Y}_T^{N, \mu_N} := \frac{1}{N} \sum_{i=1}^N \delta_{u_i},$$

where, for all $i \in \{1, \dots, N\}$,

$$u_i := u_i^{\mu_N} := x_{a(i)}^{(n)} + \int_0^T dW_s^{(B(s^-, i))}. \quad (31)$$

The well-known backward construction of the MORAN model [18, Subsection 1.2], [17, Subsection 2.8] entails the following result.

Proposition 4.4. *For all initial condition $\mu_N \in \mathcal{M}_{1,N}(\mathbb{R})$, $Y_T^N \stackrel{\text{law}}{=} \widehat{Y}_T^{N, \mu_N}$ where $Y_0^N = \mu_N$.*

4.3 Centered variables and centering effects

We construct the centered version of the random variables \widehat{Y}_T^{N,μ_N} . We define the random variable \widehat{Z}_T^{N,μ_N} as follows:

$$\widehat{Z}_T^{N,\mu_N} := \tau_{-\langle \text{id}, \widehat{Y}_T^{N,\mu_N} \rangle} \# \widehat{Y}_T^{N,\mu_N}.$$

Corollary 4.5. *For all initial condition $\mu_N \in \mathcal{M}_{1,N}^{c,2}(\mathbb{R})$, $Z_T^N \stackrel{\text{law}}{=} \widehat{Z}_T^{N,\mu_N} = \frac{1}{N} \sum_{i=1}^N \delta_{v_i}$ where, for all $i \in \{1, \dots, N\}$, $v_i := v_i^{\mu_N} := u_i - \frac{1}{N} \sum_{j=1}^N u_j$ and $Z_0^N = \mu_N$.*

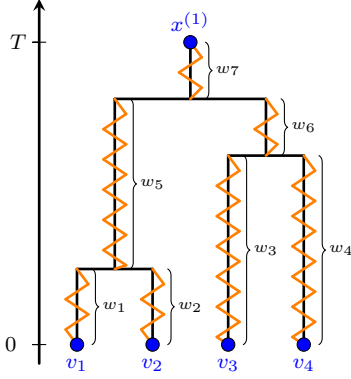

Figure 4.3: Illustration of the centered MORAN process where $|k_{4,T}| = 1$.

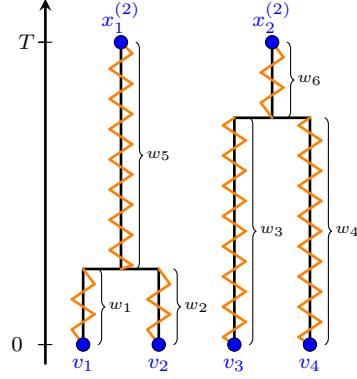

Figure 4.4: Illustration of the centered MORAN process where $|k_{4,T}| = 2$.

In the example of Figure 4.3, we can observe that

$$\begin{aligned} \widehat{Z}_T^{4,\mu_4} &= \frac{1}{4} \delta_{\frac{1}{2}[w_5-w_6] + \frac{3}{4}w_1 - \frac{1}{4}[w_2+w_3+w_4]} + \frac{1}{4} \delta_{\frac{1}{2}[w_5-w_6] + \frac{3}{4}w_2 - \frac{1}{4}[w_1+w_3+w_4]} \\ &\quad + \frac{1}{4} \delta_{-\frac{1}{2}[w_5-w_6] + \frac{3}{4}w_3 - \frac{1}{4}[w_1+w_2+w_4]} + \frac{1}{4} \delta_{-\frac{1}{2}[w_5-w_6] + \frac{3}{4}w_4 - \frac{1}{4}[w_1+w_2+w_3]}, \end{aligned}$$

and for Figure 4.4 that

$$\begin{aligned} \widehat{Z}_T^{4,\mu_4} &= \frac{1}{4} \delta_{\frac{1}{2}[x_1^{(2)}-x_2^{(2)}+w_5-w_6] + \frac{3}{4}w_1 - \frac{1}{4}[w_2+w_3+w_4]} + \frac{1}{4} \delta_{\frac{1}{2}[x_1^{(2)}-x_2^{(2)}+w_5-w_6] + \frac{3}{4}w_2 - \frac{1}{4}[w_1+w_3+w_4]} \\ &\quad + \frac{1}{4} \delta_{-\frac{1}{2}[x_1^{(2)}-x_2^{(2)}+w_5-w_6] + \frac{3}{4}w_3 - \frac{1}{4}[w_1+w_2+w_4]} + \frac{1}{4} \delta_{-\frac{1}{2}[x_1^{(2)}-x_2^{(2)}+w_5-w_6] + \frac{3}{4}w_4 - \frac{1}{4}[w_1+w_2+w_3]}. \end{aligned}$$

In other words, when there is just one ancestral lineage, the random variable \widehat{Z}_T^{N,μ_4} is independent of the ancestral position $x^{(1)}$. In general, when $n = |k_{N,T}| = 1$,

$$v_i = \int_0^T dW_s^{B(s^-,i)} - \frac{1}{N} \sum_{j=1}^N \int_0^T dW_s^{B(s^-,j)} \quad (32)$$

does not depend on the ancestral lineage: this is the centering effect.

For any fixed $T > 0$, for all $i, j \in \{1, \dots, N\}$, let us consider T_{ij} the coalescence time between the individuals i and j at time T in the process $(k_{N,t})_{0 \leq t \leq T}$. In the following proposition we establish that $(v_i)_{1 \leq i \leq N}$ is a centered Gaussian vector whose covariance matrix is an explicit function of T_{ij} .

Proposition 4.6. (1) For any fixed $T > 0$, for all $\mu_N \in \mathcal{M}_{1,N}^{c,2}(\mathbb{R})$, conditionally to $k_N := (k_{N,t})_{0 \leq t \leq T}$, on the event $\{|k_{N,T}| = 1\}$, we have for all $i, j \in \{1, \dots, N\}$, $\text{Cov}(u_i, u_j | k_N) = T - T_{ij}$.

(2) Conditionally to k_N , on the event $\{|k_{N,T}| = 1\}$, $(v_i)_{1 \leq i \leq N} \sim \mathcal{N}^{(N)}(0_{\mathbb{R}^N}, \Sigma)$ where $\Sigma := (\Sigma_{ij})_{1 \leq i, j \leq N}$ is define by

$$\forall i, j \in \{1, \dots, N\}, \Sigma_{ij} := \text{Cov}(v_i, v_j | k_N) = \frac{1}{N} \sum_{k=1}^N (T_{ik} + T_{jk}) - \left(T_{ij} + \frac{1}{N^2} \sum_{k, \ell=1}^N T_{k\ell} \right).$$

Proof. (1) It is a straightforward computation from (31).

(2) Noting that for all $i, j \in \{1, \dots, N\}$, $T_{ij} = T_{ji}$ and $T_{ii} = 0$ and from (32), we deduce the announced result by a straightforward computation. \square

4.4 Coupling arguments with two distincts initial conditions

In this subsection, we want to couple centered MORAN's processes from different initial conditions but with the same KINGMAN genealogy and the same mutations in order to establish the following exponential ergodicity result.

Proposition 4.7. For all $\mu_N, \nu_N \in \mathcal{M}_{1,N}^{c,2}(\mathbb{R})$, for all $T \geq 0$, there exists constants $\alpha, \beta \in (0, +\infty)$, independent of μ_N, ν_N, T and N such that

$$\left\| \widehat{\mathbb{P}} \left(\widehat{Z}_T^{N, \mu_N} \in \cdot \right) - \widehat{\mathbb{P}} \left(\widehat{Z}_T^{N, \nu_N} \in \cdot \right) \right\|_{TV} \leq \alpha \exp(-\beta T).$$

In particular, for all $N \in \mathbb{N}^*$ there exists a unique invariant probability measure π_N for the centered MORAN process $(Z_t^N)_{t \geq 0}$ such that for all $\mu_N \in \mathcal{M}_{1,N}^{c,2}(\mathbb{R})$, for all $T \geq 0$,

$$\left\| \mathbb{P}_{\mu_N} \left(Z_T^N \in \cdot \right) - \pi_N \right\|_{TV} \leq \alpha \exp(-\beta T).$$

Remark 4.8. The previous result is true for all deterministic initial conditions, so also for any random initial conditions.

Proof. Step 1. Coupling. Let $\widehat{\omega}_{\mu_N}$ and $\widehat{\omega}_{\nu_N}$ be two elements of $\widehat{\Omega}$ which have the same KINGMAN genealogy $(k_{N,t})_{0 \leq t \leq T}$ and the same mutation but whose initial conditions $\mu_N := \frac{1}{N} \sum_{i=1}^N \delta_{x_{a(i)}^{(n)}}$ and $\nu_N := \frac{1}{N} \sum_{i=1}^N \delta_{y_{a(i)}^{(n)}}$ are different where $n = |k_{N,T}|$. We assume that the $x_{a(i)}^{(n)}$ respectively $y_{a(i)}^{(n)}$ are selected randomly and without replacement in $\{x_1, \dots, x_N\}$ respectively

$\{y_1, \dots, y_N\}$, independently. This allows us to construct, on the same probability space, two random variables

$$\widehat{Z}_T^{N, \mu_N} := \frac{1}{N} \sum_{i=1}^N \delta_{v_i^{\mu_N}} \quad \text{and} \quad \widehat{Z}_T^{N, \nu_N} := \frac{1}{N} \sum_{i=1}^N \delta_{v_i^{\nu_N}}$$

such that $Z_T^{N, \mu_N} \stackrel{\text{law}}{=} \widehat{Z}_T^{N, \mu_N}$ and $Z_T^{N, \nu_N} \stackrel{\text{law}}{=} \widehat{Z}_T^{N, \nu_N}$.

Step 2. Control in total variation. From (32), on the event $\{|k_{N,T}| = 1\}$, we have that for all $i \in \{1, \dots, N\}$, $v_i^{\mu_N} = v_i^{\nu_N}$ a.s. and from [35] we deduce that

$$\begin{aligned} \left\| \widehat{\mathbb{P}} \left(\widehat{Z}_T^{N, \mu_N} \in \cdot \right) - \widehat{\mathbb{P}} \left(\widehat{Z}_T^{N, \nu_N} \in \cdot \right) \right\|_{TV} &\leq \widehat{\mathbb{P}} \left(\widehat{Z}_T^{N, \mu_N} \neq \widehat{Z}_T^{N, \nu_N} \right) \\ &= 1 - \mathbb{K}_{N,T} (|k_{N,T}| = 1). \end{aligned}$$

We denote by $H_N := \sum_{k=2}^N T_k$ the height of the KINGMAN N -coalescent where $(T_k)_{2 \leq k \leq N}$ are independent random variables such that T_k follows an exponential law of parameter $\gamma \binom{k}{2}$ [17, Lemma 2.20]. Now, $\mathbb{K}_{N,T} (|k_{N,T}| = 1) \geq \mathbb{K}_{\infty,T} (|k_{\infty,T}| = 1) = \mathbb{K}_{\infty,T} (H_\infty \leq T)$ and by the exponential TCHEBYCHEV inequality we have

$$\mathbb{K}_{\infty,T} (H_\infty > T) \leq \inf_{\lambda \in]0, \gamma[} \frac{\mathbb{E}(\exp(\lambda H_\infty))}{\exp(\lambda T)}.$$

Note that for all $\lambda \in]0, \gamma[$,

$$\mathbb{E}(\exp(\lambda H_\infty)) = \prod_{k=2}^{+\infty} \mathbb{E}(\exp(\lambda T_k)) = \frac{\gamma}{\gamma - \lambda} \prod_{k=3}^{+\infty} \frac{1}{1 - \frac{2\lambda}{\gamma k(k-1)}},$$

where the last product is convergent. We deduce that

$$\mathbb{K}_{\infty,T} (H_\infty > T) \leq C \inf_{\lambda \in]0, \gamma[} \frac{1}{(\gamma - \lambda) \exp(\lambda T)} = C \gamma \exp(1) T \exp(-\gamma T),$$

where $C := \prod_{k=3}^{+\infty} \frac{1}{1 - \frac{2}{\gamma k(k-1)}}$. The result follows for $\alpha = C \gamma \exp(1) T$ and $\beta = \gamma$. \square

4.5 Proof of Theorem 4.1

Classically, it is sufficient to check that there exists constants $\alpha, \beta \in \mathbb{R}_+$ such that for all $\mu, \nu \in \mathcal{M}_1^{c,2}(\mathbb{R})$, for all $T \geq 0$,

$$\left\| \mathbb{P}_\mu (Z_T \in \cdot) - \mathbb{P}_\nu (Z_T \in \cdot) \right\|_{TV} \leq \alpha \exp(-\beta T).$$

From LUSIN's theorem [48, Corollary of Theorem 2.24], Proposition 4.7 and Corollary 4.5 there exists two constants $\alpha, \beta \in (0, +\infty)$ such that for all $\mu_N, \nu_N \in \mathcal{M}_{1,N}^{c,2}(\mathbb{R})$, for all $T \geq 0$,

$$\begin{aligned} \sup_{\substack{\|f\|_\infty \leq 1 \\ f \text{ continuous}}} \left| \mathbb{E}_{\mu_N} (f(Z_T^N)) - \mathbb{E}_{\nu_N} (f(Z_T^N)) \right| &= \sup_{\|f\|_\infty \leq 1} \left| \mathbb{E}_{\mu_N} (f(Z_T^N)) - \mathbb{E}_{\nu_N} (f(Z_T^N)) \right| \\ &\leq \alpha \exp(-\beta T). \end{aligned}$$

Now, let be fixed two deterministic initial conditions $\mu, \nu \in \mathcal{M}_1^{c,2}(\mathbb{R})$ and consider an i.i.d. sample $(X_i)_{1 \leq i \leq N}$ of distribution μ and an i.i.d. sample $(\tilde{X}_i)_{1 \leq i \leq N}$ of distribution ν . Then, we construct two initial conditions $\mu_N = \frac{1}{N} \sum_{i=1}^N \delta_{X_i}$ and $\nu_N = \frac{1}{N} \sum_{i=1}^N \delta_{\tilde{X}_i}$ such that μ_N and ν_N converge in law respectively to μ and ν . We define $\tilde{\mu}_N := \tau_{-\langle \text{id}, \mu_N \rangle} \# \mu_N$ and $\tilde{\nu}_N := \tau_{-\langle \text{id}, \nu_N \rangle} \# \nu_N$ such that $\tilde{\mu}_N, \tilde{\nu}_N \in \mathcal{M}_{1,N}^{c,2}(\mathbb{R})$. By construction, the assumptions of exchangeability of the random variables $(X_i)_{1 \leq i \leq N}$ and $(\tilde{X}_i)_{1 \leq i \leq N}$ are satisfied, $\tilde{\mu}_N$ and $\tilde{\nu}_N$ converge in law respectively to μ and ν and we have

$$\mathbb{E}(\langle \text{id}^2, \tilde{\mu}_N \rangle) = \mathbb{E}(\langle \text{id}^2, \mu_N \rangle - \langle \text{id}, \mu_N \rangle^2) = \left(1 - \frac{1}{N}\right) \text{Var}(X_1) < \infty.$$

Then, we deduce from Proposition 4.2 that for all $f \in \mathcal{C}_b^0(\mathbb{R}, \mathbb{R})$ satisfying $\|f\|_\infty \leq 1$, for all $T \geq 0$,

$$|\mathbb{E}_\mu f(Z_T) - \mathbb{E}_\nu f(Z_T)| = \lim_{N \rightarrow +\infty} \left| \mathbb{E}_{\mu_N} (f(Z_T^N)) - \mathbb{E}_{\nu_N} (f(Z_T^N)) \right| \leq \alpha \exp(-\beta T)$$

which concludes the proof. \square

4.6 Characterisation of the invariant probability measure

In this subsection, we characterise the invariant probability measure of the centered FLEMING-VIOT process π thanks to an adaptation of DONNELLY-KURTZ's modified look-down construction whose original construction of [13, 14] is recalled in Subsubsection 4.6.1. We give in Subsubsection 4.6.2 an explicit characterisation of the invariant probability measure π . Let us begin by giving a convergence result of the invariant probability measure π_N to the invariant probability measure π .

Lemma 4.9. *The sequence of laws $(\pi_N)_{N \in \mathbb{N}^*}$ converges in law to π in $\mathcal{M}_1(\mathcal{M}_1(\mathbb{R}))$.*

Proof. Let $T \geq 0$, $\mu_N \in \mathcal{M}_{1,N}^{c,2}(\mathbb{R})$ and $\mu \in \mathcal{M}_1^{c,2}(\mathbb{R})$ such that μ_N converges in law to μ . From Proposition 4.7 and Theorem 4.1, we have for all $f \in \mathcal{C}_b^0(\mathcal{M}_1(\mathbb{R}), \mathbb{R})$,

$$\begin{aligned} |\langle f, \pi_N \rangle - \langle f, \pi \rangle| &\leq \left| \langle f, \pi_N \rangle - \mathbb{E}_{\mu_N} (f(\widehat{Z}_T^{N, \mu_N})) \right| + \left| \mathbb{E}_{\mu_N} (f(\widehat{Z}_T^{N, \mu_N})) - \mathbb{E}_\mu (f(Z_T)) \right| \\ &\quad + |\mathbb{E}_\mu (f(Z_T)) - \langle f, \pi \rangle| \\ &\leq 2 \|f\|_\infty \alpha \exp(-\beta T) + \left| \mathbb{E}_{\mu_N} (f(\widehat{Z}_T^{N, \mu_N})) - \mathbb{E}_\mu (f(Z_T)) \right|. \end{aligned}$$

The announced result follows from Proposition 4.2. \square

4.6.1 Construction of exchangeable random variables allowing to characterise π_N and π

We consider the probability space $(\check{\Omega}, \check{\mathcal{F}}, \check{\mathbb{P}})$ where we define the modified look-down process on $(-\infty, 0]$ as a population dynamics on the set \mathbb{N} of levels where one individual is assigned to each level. To each pair of levels $(i, j) \in \mathbb{N}^2$ with $1 \leq i < j$, we assign an independent POISSON process $(N_{ij}(t))_{t \geq 0}$ with intensity γ and to each level $i \in \mathbb{N}^*$, we assign an independent standard Brownian motion $(B_i(t))_{t \leq 0}$ on \mathbb{R}_- . Jointly with the modified look-down is constructed for all $N \in \mathbb{N}^*$, the so-called N -look-down process whose evolution is given as follows:

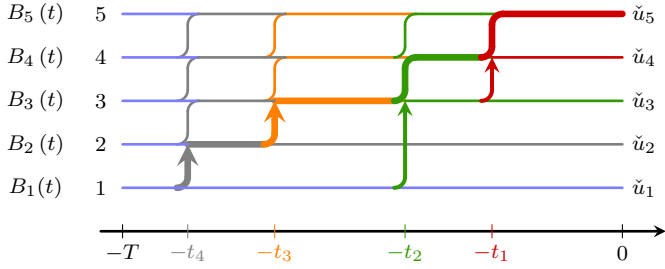

Figure 4.5: Graphical representation of the modified look-down process with $N = 5$.

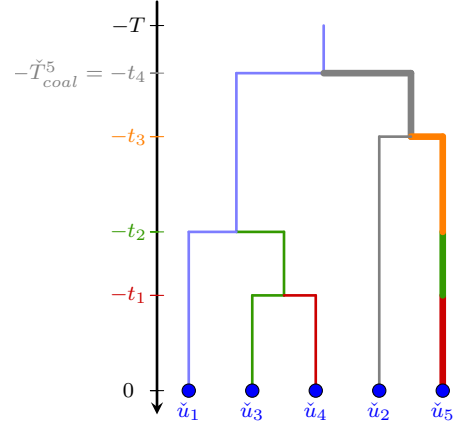

Figure 4.6: KINGMAN's genealogy $(\check{k}_{5,t})_{0 \leq t \leq T}$ under the modified look-down model on the left, tracing back from time 0 to time $-T$.

- (1) **Birth/Death rule.** Each jump time t_k of one of the POISSON process $(N_{ij})_{1 \leq i < j \leq N}$ corresponds to a reproduction event at backward time $-t_k$. When the time t_k is the jump time of the POISSON process N_{ij} , we put an arrow from i to j as illustrated in Figure 4.5 which means that the individual at level i puts a child at level j . The offspring at level j adopts the current spatial position of its parent at level i . The parent level and position do not change. Individuals previously at level $\ell \in \{j, \dots, N-1\}$ are shifted one level up to $\ell + 1$ and the individual at level N dies.
- (2) **Spatial motion.** Between reproduction events, individuals' spatial positions at each level i evolve according to the standard Brownian motion $B_i(-t)$. As explain below, we will fix the position of the individual at level 1 at coalescence time to 0.

Note that the N -modified look-down process is simply the first N levels of the $(N+k)$ -modified look-down for any $k \in \mathbb{N}^*$. In other words, the modified look-down construction can be done with an infinite population as a projective limit of the so-called (infinite) modified look-down. From [13, 14], the genealogy $(\check{k}_{N,t})_{t \geq 0}$ in backward time since time 0 of a sample from a population evolving according to the N -modified look-down is exactly determined by KINGMAN's N -coalescent with coalescence rate γ . In Figure 4.6 we give the KINGMAN genealogy associated to the 5-modified look-down of the Figure 4.5.

We denote by $a(i, t)$, $i \in \{1, \dots, N\}$, $t \in (-\infty, 0]$, the ancestor level of the individual at level i at time t . For example, in Figure 4.5, for all $t \in]-t_3, -t_4]$, $a(5, t) = 2$ and for all

$t \in] - t_2, -t_4]$, $a(3, t) = 1$. Let us consider the random variables

$$\begin{aligned}\check{T}_{coal}^N &:= \inf \left\{ T \geq 0 \mid a(i, -T) = 1, \forall i \in \{1, \dots, N\} \right\}, \\ \check{T}_{coal}^\infty &:= \inf \left\{ T \geq 0 \mid a(i, -T) = 1, \forall i \in \mathbb{N}^* \right\},\end{aligned}$$

which can be interpreted respectively as the coalescence time (i.e. the first time where $|\check{k}_{N,t} = 1$) of the KINGMAN N -coalescent $(\check{k}_{N,t})_{t \geq 0}$ and the KINGMAN coalescent $(\check{k}_{\infty,t})_{t \geq 0}$. Note that, for all $N \in \mathbb{N}^*$, $\check{T}_{coal}^N \leq \check{T}_{coal}^\infty$ \mathbb{P} -a.s. In Proposition 4.10, we establish that \check{T}_{coal}^∞ admits moments of any order. We shall be interested in the spatial position \check{u}_i of the individual at level $i \in \mathbb{N}^*$ at time 0 assuming that the position of its ancestor at backward time $-\check{T}_{coal}^\infty$ is 0. For example, if we assume that, in Figure 4.6, $\check{T}_{coal}^\infty = \check{T}_{coal}^5 = t_4$, then the spatial position of the individual at level 5 at backward time $-\check{T}_{coal}^\infty$, represented by the curve in bold in Figures 4.5 and 4.6, is

$$\check{u}_5 := B_2(-t_4) - B_2(-t_3) + B_3(-t_3) - B_3(-t_2) + B_4(-t_2) - B_4(-t_1) + B_5(-t_1).$$

Similarly, $\check{u}_1 := B_1(-t_4)$, $\check{u}_2 := B_2(-t_4)$, $\check{u}_3 := B_1(-t_4) - B_1(-t_2) + B_3(-t_2)$, $\check{u}_4 := B_1(-t_4) - B_1(-t_2) + B_3(-t_2) - B_3(-t_1) + B_4(-t_1)$. In general, we define for all $i \in \mathbb{N}^*$, the random variable

$$\check{u}_i := \int_{-\check{T}_{coal}^\infty}^0 dB_{a(i,t)}(t).$$

Proposition 4.10. *For all $k \in \mathbb{N}$, there exists a constant $C_k > 0$ such that $\mathbb{E} \left((\check{T}_{coal}^\infty)^k \right) \leq C_k$.*

Proof. Note that $\check{T}_{coal}^\infty = \sum_{k=2}^{+\infty} T_k$ where $(T_k)_{k \geq 2}$ are independent random variables such that T_k follows an exponential law of parameter $\gamma \binom{k}{2}$. As previously in Step 2 of the proof of Proposition 4.7, there exists a constant $C > 0$ such that for all $\lambda \in]0, \gamma[$,

$$\mathbb{E} \left(\exp \left(\lambda \check{T}_{coal}^\infty \right) \right) = \prod_{k=2}^{+\infty} \frac{1}{1 - \frac{2\lambda}{\gamma k(k-1)}} \leq \exp(C\lambda).$$

From the inequality: for all $x \in \mathbb{R}_+$, $x^k \leq \left(\frac{2k}{\gamma \exp(1)} \right)^k \exp \left(\frac{\gamma}{2} x \right)$, we deduce that

$$\mathbb{E} \left((\check{T}_{coal}^\infty)^k \right) \leq \left(\frac{2k}{\gamma \exp(1)} \right)^k \mathbb{E} \left(\exp \left(\frac{\gamma}{2} \check{T}_{coal}^\infty \right) \right) \leq C_k$$

where $C_k := \left(\frac{2k}{\gamma \exp(1)} \right)^k \exp \left(\frac{C\gamma}{2} \right)$ which ends the proof. \square

In view of (32), it is natural to introduce for all $N, i \in \mathbb{N}^*$, $\check{v}_i^N := \check{u}_i - \frac{1}{N} \sum_{j=1}^N \check{u}_j$. In the following proposition, we give analogous results to those of Proposition 4.6.

Proposition 4.11. (1) Conditionally to $\check{k}_N := (\check{k}_{N,t})_{t \geq 0}$, on the event $\left\{|\check{k}_{N,T}| = 1\right\}$, we have for all $i, j \in \{1, \dots, N\}$, $\text{Cov}(\check{u}_i, \check{u}_j \mid \check{k}_N) = \check{T}_{coal}^\infty - \check{T}_{ij}$, where \check{T}_{ij} is the coalescence time between individuals at level i and j at time 0.

(2) Conditionally to \check{k}_N , on the event $\left\{|\check{k}_{N,T}| = 1\right\}$, $(\check{v}_i^N)_{1 \leq i \leq N} \sim \mathcal{N}^{(N)}(0_{\mathbb{R}^N}, \check{\Sigma})$ where $\check{\Sigma} := (\check{\Sigma}_{ij})_{1 \leq i, j \leq N}$ is define by

$$\forall i, j \in \{1, \dots, N\}, \check{\Sigma}_{ij} := \text{Cov}(\check{v}_i^N, \check{v}_j^N \mid \check{k}_N) = \frac{1}{N} \sum_{k=1}^N (\check{T}_{ik} + \check{T}_{jk}) - \left(\check{T}_{ij} + \frac{1}{N^2} \sum_{k, \ell=1}^N \check{T}_{k\ell} \right).$$

Proof. The proof is similar to that of Proposition 4.6. \square

Let us define respectively the empirical distribution of $(\check{u}_i)_{1 \leq i \leq N}$ and its centered version by

$$\check{Y}_{coal}^N := \frac{1}{N} \sum_{i=1}^N \delta_{\check{u}_i} \quad \text{and} \quad \check{Z}_{coal}^N := \frac{1}{N} \sum_{i=1}^N \delta_{\check{v}_i^N}.$$

Proposition 4.12. The measure-valued random variable \check{Z}_{coal}^N has the law π_N .

Proof. The proof consists in establishing for all $f : \mathcal{M}_1^{c,2}(\mathbb{R}) \rightarrow \mathbb{R}$ measurable real bounded function, $\mathbb{E}(f(\check{Z}_{coal}^N)) = \int_{\mathcal{M}_1^{c,2}(\mathbb{R})} f(\mu) \pi_N(d\mu)$. From Proposition 4.7, it is sufficient to establish for all $\mu_N \in \mathcal{M}_{1,N}^{c,2}(\mathbb{R})$, that $\lim_{T \rightarrow +\infty} \left| \mathbb{E}(f(\check{Z}_{coal}^N)) - \mathbb{E}(f(\widehat{Z}_T^{N, \mu_N})) \right| = 0$.

Let $f : \mathcal{M}_1^{c,2}(\mathbb{R}) \rightarrow \mathbb{R}$ be a measurable real bounded function. Note that,

$$\begin{aligned} \left| \mathbb{E}(f(\check{Z}_{coal}^N)) - \mathbb{E}(f(\widehat{Z}_T^{N, \mu_N})) \right| &\leq \left| \mathbb{E}(f(\check{Z}_{coal}^N) \mathbf{1}_{\{|\check{k}_{N,T}|=1\}}) - \mathbb{E}(f(\widehat{Z}_T^{N, \mu_N}) \mathbf{1}_{\{|k_{N,T}|=1\}}) \right| \\ &\quad + \|f\|_\infty \left[\check{\mathbb{P}}(|\check{k}_{N,T}| > 1) + \widehat{\mathbb{P}}(|k_{N,T}| > 1) \right]. \end{aligned}$$

Now, from Propositions 4.6 and 4.11, it follows that for all $\mu_N \in \mathcal{M}_{1,N}^{c,2}(\mathbb{R})$,

$$\widehat{Z}_T^{N, \mu_N} \mathbf{1}_{\{|k_{N,T}|=1\}} \stackrel{\text{law}}{=} \check{Z}_{coal}^N \mathbf{1}_{\{|\check{k}_{N,T}|=1\}}.$$

As established in Step 2 of the proof of Proposition 4.7,

$$\lim_{T \rightarrow +\infty} \check{\mathbb{P}}(|\check{k}_{N,T}| > 1) = \lim_{T \rightarrow +\infty} \widehat{\mathbb{P}}(|k_{N,T}| > 1) = 0,$$

which concludes the proof. \square

In the next proposition, we establish the exchangeability property of the family $(\check{u}_i)_{i \in \mathbb{N}^*}$ which will allow to apply the DE FINETTI representation theorem.

Proposition 4.13. (1) The family $(\check{u}_i)_{i \in \mathbb{N}^*}$ is exchangeable.

(2) There exists a random variable measure-valued $\check{Y}_{coal}^\infty : \check{\Omega} \rightarrow \mathcal{M}_1(\mathbb{R})$ such that $(\check{Y}_{coal}^N)_{N \in \mathbb{N}^*}$ converges $\check{\mathbb{P}}$ -a.s. when $N \rightarrow +\infty$ to \check{Y}_{coal}^∞ in $\mathcal{M}_1(\mathbb{R})$ which is equipped with the weak topology. Moreover, given \check{Y}_{coal}^∞ , $(\check{u}_i)_{i \in \mathbb{N}^*}$ is i.i.d. of law \check{Y}_{coal}^∞ .

Proof. (1) From [13, Proof of Theorem 2.2], it is enough to show for each $N \in \mathbb{N}^*$, $(\check{u}_i)_{1 \leq i \leq N}$ is exchangeable. Let $\sigma : \mathbb{N}^* \rightarrow \mathbb{N}^*$ be a finite permutation, that is to say a bijection that leaves all but finitely many points unchanged. The well-known backward construction of the modified look-down process [13, 14] entails that $(\check{k}_{\infty,t})_{t \geq 0} \stackrel{\text{law}}{=} (\check{k}_{\infty,t}^\sigma)_{t \geq 0}$ where $\check{k}_{\infty,t}^\sigma$ is the partition obtained by applying the permutation σ to $\check{k}_{\infty,t}$. Therefore, for any permutation $\sigma : \{1, \dots, N\} \rightarrow \{1, \dots, N\}$ extended by id to \mathbb{N}^* , it is sufficient to prove that $((\check{u}_i)_{1 \leq i \leq N} \mid \check{k}_\infty) \stackrel{\text{law}}{=} ((\check{u}_{\sigma(i)})_{1 \leq i \leq N} \mid \check{k}_\infty)$ to obtain the announced result.

We define $\check{T}_{coal}^{\infty,\sigma} := \check{T}_{coal}^\infty(\check{k}_\infty^\sigma)$ and for all $i, j \in \{1, \dots, N\}$, $\check{T}_{ij}^\sigma := \check{T}_{ij}(\check{k}_\infty^\sigma)$. Note that $\check{T}_{coal}^{\infty,\sigma} = \check{T}_{coal}^\infty$ $\check{\mathbb{P}}$ -a.s. and it follows from the fact $(\check{k}_{\infty,t})_{t \geq 0} \stackrel{\text{law}}{=} (\check{k}_{\infty,t}^\sigma)_{t \geq 0}$ that

$$((\check{T}_{ij}^\sigma, \check{T}_{coal}^{\infty,\sigma}))_{1 \leq i, j \leq N} \stackrel{\text{law}}{=} ((\check{T}_{ij}, \check{T}_{coal}^\infty))_{1 \leq i, j \leq N}.$$

From Proposition 4.11, for all $f : \mathbb{R}^N \rightarrow \mathbb{R}$ measurable real bounded function,

$$\mathbb{E} \left(f(\check{u}_1, \dots, \check{u}_N) \mid \check{k}_\infty \right) = F \left((\check{T}_{ij})_{1 \leq i < j \leq N}, \check{T}_{coal}^\infty \right).$$

for a certain function F . So, in particular

$$\mathbb{E} \left(f(\check{u}_{\sigma(1)}, \dots, \check{u}_{\sigma(N)}) \mid \check{k}_\infty^\sigma \right) = F \left((\check{T}_{ij}^\sigma)_{1 \leq i < j \leq N}, \check{T}_{coal}^{\infty,\sigma} \right).$$

By taking the expectation in the previous expressions, we deduce that $\mathbb{E} \left(f(\check{u}_{\sigma(1)}, \dots, \check{u}_{\sigma(N)}) \right) = \mathbb{E} \left(f(\check{u}_1, \dots, \check{u}_N) \right)$ which completes the proof.

(2) As the family $(\check{u}_i)_{i \in \mathbb{N}^*}$ is exchangeable, the announced result follows from DE FINETTI's representation theorem [32, Theorem 12.26 and Remark 12.27]. \square

We conclude this subsection with a corollary which will be useful to characterise the probability measure π .

Corollary 4.14. (1) For all $k \in \mathbb{N}$, the random variable \check{Y}_{coal}^∞ satisfies $\langle |\text{id}|^k, \check{Y}_{coal}^\infty \rangle < \infty$ $\check{\mathbb{P}}$ -a.s.

(2) The limit $\check{u}_\infty := \lim_{N \rightarrow +\infty} \frac{1}{N} \sum_{j=1}^N \check{u}_j$ exists $\check{\mathbb{P}}$ -a.s. and satisfies $\check{u}_\infty = \langle \text{id}, \check{Y}_{coal}^\infty \rangle$.

Proof. (1) For all $M \in (0, +\infty)$, let us consider $|\text{id}|_M$ the truncation function of id at level M defined by $|\text{id}|_M = |\text{id}|$ on $[-M, M]$ and $|\text{id}|_M = M$ on $\mathbb{R} \setminus [-M, M]$. By FATOU's lemma, we obtain that

$$\mathbb{E} \left(\langle |\text{id}|_M^k, \check{Y}_{coal}^\infty \rangle \right) \leq \liminf_{N \rightarrow +\infty} \mathbb{E} \left(\langle |\text{id}|_M^k, \check{Y}_{coal}^N \rangle \right) \leq \liminf_{N \rightarrow +\infty} \frac{1}{N} \sum_{i=1}^N \left(1 + \mathbb{E} \left(\check{u}_i^{2k} \right) \right).$$

Now, classical moment results for Gaussian random variables show that for all $n \in \mathbb{N}$, $\mathbb{E}(G^{2n}) = \frac{(2n)!}{2^n n!} \sigma^{2n}$ for $G \sim \mathcal{N}(0, \sigma^2)$. From Proposition 4.11,

$$\mathbb{E}(\check{u}_i^{2k}) = \mathbb{E}\left(\mathbb{E}(\check{u}_i^{2k} \mid \check{k}_N)\right) = \frac{(2k)!}{2^k k!} \mathbb{E}\left(\left(\check{T}_{coal}^\infty\right)^k\right).$$

Therefore, from Proposition 4.10, we deduce that there exists a constant $C_k > 0$ such that $\mathbb{E}\left(\langle \text{id} \mid_M^k, \check{Y}_{coal}^\infty \rangle\right) \leq 1 + \frac{(2k)!}{2^k k!} C_k$ and by the dominated convergence theorem when $M \rightarrow +\infty$, the announced result follows.

(2) From Proposition 4.13, given \check{Y}_{coal}^∞ , $(\check{u}_i)_{i \in \mathbb{N}^*}$ is i.i.d. Therefore, the announced almost surely existence limit follows from the Strong Law of Large Numbers. Moreover,

$$\langle \text{id}, \check{Y}_{coal}^\infty \rangle = \lim_{N \rightarrow +\infty} \langle \text{id}, \check{Y}_{coal}^N \rangle = \lim_{N \rightarrow +\infty} \frac{1}{N} \sum_{j=1}^N \check{u}_j = \check{u}_\infty, \quad \check{\mathbb{P}} - \text{a.s.} \quad \square$$

4.6.2 Characterisation of the invariant probability measure π

Now we define the random variable $\check{Z}_{coal}^\infty \in \mathcal{M}_1(\mathbb{R})$ as

$$\check{Z}_{coal}^\infty := \tau_{-\langle \text{id}, \check{Y}_{coal}^\infty \rangle} \# \check{Y}_{coal}^\infty.$$

The following proposition establishes the convergence of $(\check{Z}_{coal}^N)_{N \in \mathbb{N}^*}$ to \check{Z}_{coal}^∞ . Let us recall the following well-known fact useful for the proof below: a straightforward adaptation of the proof of [8, Lemma 2.1.2] allows us to obtain that for all $d \in \mathbb{N}^*$, the algebra of polynomials

$$\text{Span}\left(\left\{\langle f, \mu^d \rangle \mid f : \mathbb{R}^d \rightarrow \mathbb{R} \text{ uniformly continuous, } \mu \in \mathcal{M}_1(\mathbb{R})\right\}\right)$$

is convergence determining in $\mathcal{M}_1(\mathcal{M}_1(\mathbb{R}))$.

Proposition 4.15. (1) *The sequence of random variables $(\check{Z}_{coal}^N)_{N \in \mathbb{N}^*}$ converges $\check{\mathbb{P}}$ -a.s. when $N \rightarrow +\infty$ to \check{Z}_{coal}^∞ in $\mathcal{M}_1(\mathbb{R})$ for the weak convergence topology.*

(2) *The random variable \check{Z}_{coal}^∞ has the law π .*

Proof. (1) From the previous reminder, it is sufficient to prove that for all $d \in \mathbb{N}^*$, for all $f : \mathbb{R}^d \rightarrow \mathbb{R}$ uniformly continuous, $\lim_{N \rightarrow +\infty} \langle f, (\check{Z}_{coal}^N)^d \rangle = \langle f, (\check{Z}_{coal}^\infty)^d \rangle$. With an argument similar to the proof of Proposition 4.2, we obtain that for all $d \in \mathbb{N}^*$, for all $f : \mathbb{R}^d \rightarrow \mathbb{R}$ uniformly continuous,

$$F_d : \begin{array}{ccc} \mathcal{M}_1^1(\mathbb{R}) & \longrightarrow & \mathbb{R} \\ \mu & \longmapsto & \langle f \circ \tau_{-\langle \text{id}, \mu \rangle}, \mu^d \rangle \end{array}$$

is continuous. Let $d \in \mathbb{N}^*$ and $f : \mathbb{R}^d \rightarrow \mathbb{R}$ uniformly continuous. Now, $\check{Y}_{coal}^\infty \in \mathcal{M}_1^1(\mathbb{R})$ from Corollary 4.14 and

$$F_d(\check{Y}_{coal}^N) = \langle f, (\check{Z}_{coal}^N)^d \rangle \quad \text{and} \quad F_d(\check{Y}_{coal}^\infty) = \langle f, (\check{Z}_{coal}^\infty)^d \rangle.$$

From Proposition 4.13, $\lim_{N \rightarrow +\infty} F_d(\check{Y}_{coal}^N) = F_d(\check{Y}_{coal}^\infty)$ $\check{\mathbb{P}}$ -a.s. which concludes the proof.

(2) Let $d \in \mathbb{N}^*$. As for all $N \in \mathbb{N}^*$ and $f : \mathbb{R}^d \rightarrow \mathbb{R}$ uniformly continuous,

$$\begin{aligned} & \left| \mathbb{E} \left(\langle f, (\check{Z}_{coal}^\infty)^d \rangle \right) - \int_{\mathcal{M}_1(\mathbb{R})} \langle f, \mu^d \rangle \pi(d\mu) \right| \\ & \leq \mathbb{E} \left(\left| \langle f, (\check{Z}_{coal}^\infty)^d - (\check{Z}_{coal}^N)^d \rangle \right| \right) + \left| \mathbb{E} \left(\langle f, (\check{Z}_{coal}^N)^d \rangle \right) - \int_{\mathcal{M}_1(\mathbb{R})} \langle f, \mu^d \rangle \pi_N(d\mu) \right| \\ & \quad + \left| \int_{\mathcal{M}_1(\mathbb{R})} \langle f, \mu^d \rangle [\pi(d\mu) - \pi_N(d\mu)] \right|, \end{aligned}$$

the announced result follows from Propositions 4.15 (1), and 4.12 and Lemma 4.9 when $N \rightarrow +\infty$. \square

The last characterisation of the probability measure π is suitable to make explicit computations. The next corollary give an expression of the second moment under π .

Corollary 4.16. *We have $\int_{\mathcal{M}_1^{c,2}(\mathbb{R})} M_2(\mu) \pi(d\mu) = 1/\gamma$.*

Proof. Step 1. Uniform bound in N of $\mathbb{E}(M_{2k}(\check{Z}_{coal}^N))$. In this step, we want to establish

$$\sup_{N \in \mathbb{N}^*} \mathbb{E} \left(\langle |\text{id}|^{2k}, \check{Z}_{coal}^N \rangle \right) < \infty.$$

Let $N \in \mathbb{N}^*$. From Proposition 4.13 (1),

$$\begin{aligned} \mathbb{E} \left(\langle |\text{id}|^{2k}, \check{Z}_{coal}^N \rangle \right) &= \mathbb{E} \left(\mathbb{E} \left(\left| \frac{1}{N} \sum_{i=1}^N \check{u}_i - \frac{1}{N} \sum_{j=1}^N \check{u}_j \right|^{2k} \middle| (\check{T}_{m\ell})_{1 \leq m, \ell \leq N}, \check{T}_{coal}^\infty \right) \right) \\ &= \mathbb{E} \left(\mathbb{E} \left(|\check{v}_1^N|^{2k} \middle| (\check{T}_{m\ell})_{1 \leq m, \ell \leq N}, \check{T}_{coal}^\infty \right) \right). \end{aligned}$$

From Propositions 4.11 and 4.10, we obtain that

$$\mathbb{E} \left(\mathbb{E} \left(|\check{v}_1^N|^{2k} \middle| (\check{T}_{m,\ell})_{1 \leq m, \ell \leq N}, \check{T}_{coal}^\infty \right) \right) = \frac{(2k)!}{2^k k!} \mathbb{E} \left(\check{\Sigma}_{ii}^{2k} \right) \leq \frac{(2k)!}{k!} \mathbb{E} \left((\check{T}_{coal}^\infty)^{2k} \right) < \infty,$$

and the announced result follows.

Step 2. Convergence result of $\mathbb{E}(M_2(\check{Z}_{coal}^N))$ to $\mathbb{E}(M_2(\check{Z}_{coal}^\infty))$. Note that for all $N \in \mathbb{N}^*$, $M \in (0, +\infty)$,

$$\left| \mathbb{E} \left(M_2(\check{Z}_{coal}^N) \right) - \mathbb{E} \left(M_2(\check{Z}_{coal}^\infty) \right) \right| \leq (\mathbf{A})_{N,M} + (\mathbf{B})_{N,M} + (\mathbf{C})_{N,M},$$

where

$$\begin{aligned} (\mathbf{A})_{N,M} &:= \left| \mathbb{E} \left(M_2(\check{Z}_{coal}^N) \right) - \mathbb{E} \left(\langle |\text{id}|_M^2, \check{Z}_{coal}^N \rangle \right) \right|, \\ (\mathbf{B})_{N,M} &:= \left| \mathbb{E} \left(\langle |\text{id}|_M^2, \check{Z}_{coal}^N \rangle \right) - \mathbb{E} \left(\langle |\text{id}|_M^2, \check{Z}_{coal}^\infty \rangle \right) \right|, \\ (\mathbf{C})_{N,M} &:= \left| \mathbb{E} \left(\langle |\text{id}|_M^2, \check{Z}_{coal}^\infty \rangle \right) - \mathbb{E} \left(M_2(\check{Z}_{coal}^\infty) \right) \right|. \end{aligned}$$

From the inequality $|\text{id}^2 - \text{id}_M^2| \leq \frac{2}{3\sqrt{3M}} |\text{id}|^3$, then the HÖLDER inequality, we obtain that

$$(\mathbf{A})_{N,M} \leq \mathbb{E} \left(\langle |\text{id}^2 - \text{id}_M^2|, \check{Z}_{coal}^N \rangle \right) \leq \frac{2}{3\sqrt{3M}} \mathbb{E} \left(\langle |\text{id}|^3, \check{Z}_{coal}^N \rangle \right) \leq \frac{2}{3\sqrt{3M}} \mathbb{E} \left(\langle \text{id}^4, \check{Z}_{coal}^N \rangle^{\frac{3}{4}} \right).$$

From Step 1, we deduce that for all $N \in \mathbb{N}^*$,

$$(\mathbf{A})_{N,M} \leq \frac{2}{3\sqrt{3M}} \left(1 + \sup_{N \in \mathbb{N}^*} \mathbb{E} \left(\langle \text{id}^4, \check{Z}_{coal}^N \rangle \right) \right) < \infty.$$

In similar way, we obtain that for all $N \in \mathbb{N}^*$, $(\mathbf{C})_{N,M} \leq \frac{2}{3\sqrt{3M}} \left(1 + \mathbb{E} \left(\langle \text{id}^4, \check{Z}_{coal}^\infty \rangle \right) \right)$ where $\mathbb{E} \left(\langle \text{id}^4, \check{Z}_{coal}^\infty \rangle \right) < \infty$ from Corollary 4.14 **(1)**. By the monotone convergence theorem, we deduce that for all $N \in \mathbb{N}^*$, $\mathbb{E} \left(M_2 \left(\check{Z}_{coal}^N \right) \right) = \lim_{M \rightarrow +\infty} \mathbb{E} \left(\langle |\text{id}|_M^2, \check{Z}_{coal}^N \rangle \right)$ and $\mathbb{E} \left(M_2 \left(\check{Z}_{coal}^\infty \right) \right) = \lim_{M \rightarrow +\infty} \mathbb{E} \left(\langle |\text{id}|_M^2, \check{Z}_{coal}^\infty \rangle \right)$. From Proposition 4.15, for all $M \in (0, +\infty)$, $\lim_{N \rightarrow +\infty} (\mathbf{B})_{N,M} = 0$. From classical analysis techniques, we deduce that $\lim_{N \rightarrow +\infty} \mathbb{E} \left(M_2 \left(\check{Z}_{coal}^N \right) \right) = \mathbb{E} \left(M_2 \left(\check{Z}_{coal}^\infty \right) \right)$.

Step 3. Conclusion. Note that for all $N \in \mathbb{N}^*$,

$$M_2 \left(\check{Z}_{coal}^N \right) = \langle \text{id}^2, \check{Z}_{coal}^N \rangle = \frac{1}{N} \sum_{i=1}^N \check{u}_i^2 - \frac{1}{N^2} \left[\sum_{i=1}^N \check{u}_i^2 + 2 \sum_{1 \leq i < j \leq N} \check{u}_i \check{u}_j \right].$$

From Proposition 4.11, we have for all $i, j \in \{1, \dots, N\}$, $\mathbb{E}(\check{u}_i \check{u}_j) = \mathbb{E} \left(\mathbb{E}(\check{u}_i \check{u}_j \mid \check{k}_N) \right) = \mathbb{E} \left(\check{T}_{coal}^\infty - \check{T}_{ij} \right)$ where \check{T}_{ij} is an exponential random variable with parameter γ if $i \neq j$. Therefore $\mathbb{E} \left(M_2 \left(\check{Z}_{coal}^N \right) \right) = \frac{N-1}{N} \times \frac{1}{\gamma}$. By Step 2, we deduce that $\mathbb{E} \left(M_2 \left(\check{Z}_{coal}^\infty \right) \right) = 1/\gamma$ which completes the proof. \square

5 Proof of Theorem 2.3

We divide the proof of the main result into 7 steps, each of which will constitute a subsection (Subsections 5.1 to 5.7). We recall that the aim of this proof is to prove that the law $\mathbb{P}_{\tau_{-(\text{id}, \nu)}^\# \nu}^{FVc}$ of the process $(Z_t)_{0 \leq t \leq T}$ defined by

$$\forall t \geq 0, \quad Z_t := \tau_{-(\text{id}, Y_t)}^\# Y_t,$$

under \mathbb{P}_ν^{FV} for $\nu \in \mathcal{M}_1^2(\mathbb{R})$ is solution of the martingale problem (2). We will start by considering the case with test functions $F, g \in \mathcal{C}_b^4(\mathbb{R}, \mathbb{R})$ and we will prove the extension to $F \in \mathcal{C}^2(\mathbb{R}, \mathbb{R})$ and $g \in \mathcal{C}_b^2(\mathbb{R}, \mathbb{R})$ in Subsection 5.6. In (8) there are essentially two types of terms: $\langle \text{id}, Y_t - Y_s \rangle$ and $\langle g^{(j)} \circ \tau_{-(\text{id}, Y_s)}, Y_t - Y_s \rangle$, $j \in \{0, 1, 2\}$, $s \leq t$. In Subsections 5.1 and 5.2, we prove that the two previous quantities admit a DOOB's semi-martingale decomposition. In Subsections 5.3 and 5.4, we handle all the terms in (8) involving respectively the first and second derivative of F . In Subsection 5.5, we deal with the different error terms involved in (8). Finally, in Subsection 5.7, we prove that the martingale involved in (2) is square integrable and we establish the relation (3). We conclude in Subsection 5.8 and 5.9 by proving a technical lemma used in Subsection 5.2.

5.1 Doob's semi-martingale decomposition of $\langle \text{id}, Y_t - Y_s \rangle$, $s \leq t$

In (4), $M^{\text{id}}(g)$ is well-defined only for $g \in \mathcal{C}_b^2(\mathbb{R}, \mathbb{R})$. The expression makes sense for more general functions g . The goal of this subsection is to prove that, for any $k \in \mathbb{N}$, $M^{\text{id}}(\text{id}^k)$ is the martingale part in the DOOB semi-martingale decomposition of $\langle \text{id}^k, Y_t \rangle$. In particular,

$$\langle \text{id}, Y_s - Y_{t_i^n \wedge t} \rangle = M_s^{\text{id}}(\text{id}) - M_{t_i^n \wedge t}^{\text{id}}(\text{id}), \quad s \geq t_i^n \wedge t$$

is a \mathbb{P}_ν^{FV} -martingale.

Lemma 5.1. *Let $\nu \in \mathcal{M}_1(\mathbb{R})$, possibly random and let \mathbb{P}_ν be a distribution on Ω satisfying (4) and such that Y_0 is equal in law to ν . Let $T > 0$ and $k \in \mathbb{N}$ fixed.*

(1) *If $\mathbb{E}(\langle |\text{id}|^k, \nu \rangle) < \infty$, there exist two constants $C_{k,T}, \widetilde{C}_{k,T} > 0$, such that any stochastic process $(Y_t)_{0 \leq t \leq T}$ whose law \mathbb{P}_ν satisfies*

- (a) $\sup_{t \in [0, T]} \mathbb{E}(\langle |\text{id}|^k, Y_t \rangle) \leq C_{k,T} (1 + \mathbb{E}(\langle |\text{id}|^k, \nu \rangle)),$
- (b) $\forall \alpha > 0, \quad \mathbb{P}_\nu \left(\sup_{t \in [0, T]} \langle |\text{id}|^k, Y_t \rangle \geq \alpha \right) \leq \frac{\widetilde{C}_{k,T} (1 + \mathbb{E}(\langle |\text{id}|^k, \nu \rangle))}{\alpha}.$

(2) *If $\mathbb{E}(\langle |\text{id}|^k, \nu \rangle) < \infty$, the process $(M_t^{\text{id}}(\text{id}^k))_{0 \leq t \leq T}$ defined by*

$$M_t^{\text{id}}(\text{id}^k) := \langle \text{id}^k, Y_t \rangle - \langle \text{id}^k, Y_0 \rangle - \int_0^t \left\langle \frac{k(k-1)}{2} \text{id}^{k-2}, Y_s \right\rangle ds,$$

is a continuous \mathbb{P}_ν -martingale. Moreover, $\mathbb{E}(\langle |\text{id}|^{2k}, \nu \rangle) < \infty$, $(M^{\text{id}}(\text{id}^k))_{0 \leq t \leq T}$ is a martingale in $L^2(\Omega)$ whose quadratic variation is given by

$$\langle M^{\text{id}}(\text{id}^k) \rangle_t = 2\gamma \int_0^t \left[\langle \text{id}^{2k}, Y_s \rangle - \langle \text{id}^k, Y_s \rangle^2 \right] ds.$$

Proof. The proof is similar to that of Proposition 2.11. □

5.2 Doob's semi-martingale decomposition of $\langle g^{(j)} \circ \tau_{-\langle \text{id}, Y_s \rangle}, Y_t - Y_s \rangle$, $s \leq t$, $j \in \{0, 1, 2\}$

Equation (8) involves terms of the form $\langle g^{(j)} \circ \tau_{-\langle \text{id}, Y_{t_i^n \wedge t} \rangle}, Y_{t_{i+1}^n \wedge t} - Y_{t_i^n \wedge t} \rangle$ with $j \in \{0, 1, 2\}$.

We wish to express, each of these terms using the martingale problem (4). However, this leads us to consider quantities of the form

$$M_{t_{i+1}^n \wedge t}^{\text{id}} \left(g^{(j)} \circ \tau_{-\langle \text{id}, Y_{t_i^n \wedge t} \rangle} \right) - M_{t_i^n \wedge t}^{\text{id}} \left(g^{(j)} \circ \tau_{-\langle \text{id}, Y_{t_i^n \wedge t} \rangle} \right) \quad (33)$$

with $j \in \{0, 1, 2\}$, which are not well defined at the moment. Indeed, in (33) the input argument is a predictable *random* function of the process $(Y_t)_{0 \leq t \leq T}$ while the martingale problem (4) defines $M_t^{\text{id}}(g)$ only for *deterministic* functions g . Lemma 5.2 hereafter, allows us to give a precise meaning to (33) by extending the well-defined character of the martingales of (4) to predictable input arguments. The proof of this technical lemma, given in Subsection 5.9, is based on *regular conditional probabilities*.

Lemma 5.2. *Let $t^* \in \mathbb{R}_+$ be a deterministic time and $h : \Omega \rightarrow \mathcal{C}_b^2(\mathbb{R}, \mathbb{R})$ be a measurable function satisfying the following property:*

$$\forall \omega, \omega' \in \Omega, \quad h(\omega) = h(\omega') \quad \text{if} \quad \omega|_{[0, t^*]} = \omega'|_{[0, t^*]}.$$

Then, the following process defined, for all $t \in [0, T]$, by

$$\mathcal{M}_t(\tilde{\omega}) := M_t^{\text{id}}(h(\tilde{\omega}))(\tilde{\omega}) - M_{t \wedge t^*}^{\text{id}}(h(\tilde{\omega}))(\tilde{\omega})$$

is a $\mathbb{P}_\nu^{FV}(\text{d}\tilde{\omega})$ square integrable martingale whose quadratic variation is given by

$$\langle \mathcal{M}(\tilde{\omega}) \rangle_t = 2\gamma \int_{t \wedge t^*}^t \left[\langle h^2(\tilde{\omega}_s), \tilde{\omega}_s \rangle - \langle h(\tilde{\omega}_s), \tilde{\omega}_s \rangle^2 \right] \text{d}s.$$

Lemma 5.2 with $t^* = t$ allows us to assert that (33) is a $\mathbb{P}_\nu^{FV}(\text{d}Y)$ -martingale increment. Thus, we obtain for $j \in \{0, 1, 2\}$:

$$\begin{aligned} & \left\langle g^{(j)} \circ \tau_{-\langle \text{id}, Y_{t_i^n \wedge t} \rangle}, Y_{t_{i+1}^n \wedge t} - Y_{t_i^n \wedge t} \right\rangle \\ &= \int_{t_i^n \wedge t}^{t_{i+1}^n \wedge t} \frac{1}{2} \left\langle g^{(j+2)} \circ \tau_{-\langle \text{id}, Y_{t_i^n \wedge t} \rangle}, Y_s \right\rangle \text{d}s \\ &+ M_{t_{i+1}^n \wedge t}^{\text{id}} \left(g^{(j)} \circ \tau_{-\langle \text{id}, Y_{t_i^n \wedge t} \rangle} \right) - M_{t_i^n \wedge t}^{\text{id}} \left(g^{(j)} \circ \tau_{-\langle \text{id}, Y_{t_i^n \wedge t} \rangle} \right) \end{aligned} \quad (34)$$

where $\left(M_{s \wedge t}^{\text{id}} \left(g^{(j)} \circ \tau_{-\langle \text{id}, Y_{t_i^n \wedge t} \rangle} \right) - M_{t_i^n \wedge t}^{\text{id}} \left(g^{(j)} \circ \tau_{-\langle \text{id}, Y_{t_i^n \wedge t} \rangle} \right) \right)_{s \geq t_i^n}$ is a \mathbb{P}_ν^{FV} square integrable martingale satisfying for all $s \geq t_i^n$,

$$\begin{aligned} & \left\langle M_{s \wedge t}^{\text{id}} \left(g^{(j)} \circ \tau_{-\langle \text{id}, Y_{t_i^n \wedge t} \rangle} \right) - M_{t_i^n \wedge t}^{\text{id}} \left(g^{(j)} \circ \tau_{-\langle \text{id}, Y_{t_i^n \wedge t} \rangle} \right) \right\rangle_s \\ &= 2\gamma \int_{t_i^n \wedge t}^{s \wedge t} \left[\left\langle \left(g^{(j)} \circ \tau_{-\langle \text{id}, Y_{t_i^n \wedge t} \rangle} \right)^2, Y_u \right\rangle - \left\langle g^{(j)} \circ \tau_{-\langle \text{id}, Y_{t_i^n \wedge t} \rangle}, Y_u \right\rangle^2 \right] \text{d}u. \end{aligned} \quad (35)$$

5.3 Expressions of the terms of (8) involving F'

In the rest of this proof, we use the following notations to simplify the writing. We denote for all $s \geq 0$, $R(s) := \langle \text{id}, Y_s \rangle$. We assume that $F, g \in \mathcal{C}_b^4(\mathbb{R}, \mathbb{R})$. Our goal is to prove the following lemma:

Lemma 5.3. *When the mesh of the subdivision $0 = t_0^n < t_1^n < \dots < t_{p_n}^n = T$ of $[0, T]$ tends to 0 when $n \rightarrow +\infty$, we have the following convergence in probability*

$$\lim_{n \rightarrow +\infty} \sum_{i=0}^{p_n-1} (\mathbf{A})_i = \int_0^t F'(\langle g, Z_s \rangle) \left(\left\langle \frac{g''}{2}, Z_s \right\rangle + \gamma \langle g'', Z_s \rangle M_2(Z_s) - 2\gamma \langle g' \times \text{id}, Z_s \rangle \right) + \text{Mart}_t,$$

where $(\text{Mart}_t)_{0 \leq t \leq T}$ is a \mathbb{P}_ν^{FV} -martingale.

The proof of Lemma 5.3 is based on the following decomposition of $(\mathbf{A})_i$ (given by the expression (9)) and using the DOOB semi-martingale decomposition of Subsections 5.1 and 5.2. We have

$$(\mathbf{A})_i = \sum_{k=1}^6 F' \left(\left\langle g \circ \tau_{-R(t_i^n \wedge t)}, Y_{t_i^n \wedge t} \right\rangle \right) (\mathbf{A})_i^k$$

where

$$\begin{aligned} (\mathbf{A})_i^1 &= \int_{t_i^n \wedge t}^{t_{i+1}^n \wedge t} \frac{1}{2} \left\langle g'' \circ \tau_{-R(t_i^n \wedge t)}, Y_s \right\rangle ds, \\ (\mathbf{A})_i^2 &= M_{t_{i+1}^n \wedge t}^{\text{id}} \left(g \circ \tau_{-R(t_i^n \wedge t)} \right) - M_{t_i^n \wedge t}^{\text{id}} \left(g \circ \tau_{-R(t_i^n \wedge t)} \right), \\ (\mathbf{A})_i^3 &= - \left[M_{t_{i+1}^n \wedge t}^{\text{id}}(\text{id}) - M_{t_i^n \wedge t}^{\text{id}}(\text{id}) \right] \left\langle g' \circ \tau_{-R(t_i^n \wedge t)}, Y_{t_i^n \wedge t} \right\rangle, \\ (\mathbf{A})_i^4 &= - \left[M_{t_{i+1}^n \wedge t}^{\text{id}}(\text{id}) - M_{t_i^n \wedge t}^{\text{id}}(\text{id}) \right] \left[M_{t_{i+1}^n \wedge t}^{\text{id}} \left(g' \circ \tau_{-R(t_i^n \wedge t)} \right) - M_{t_i^n \wedge t}^{\text{id}} \left(g' \circ \tau_{-R(t_i^n \wedge t)} \right) \right], \\ (\mathbf{A})_i^5 &= \frac{1}{2} \left[M_{t_{i+1}^n \wedge t}^{\text{id}}(\text{id}) - M_{t_i^n \wedge t}^{\text{id}}(\text{id}) \right]^2 \left\langle g'' \circ \tau_{-R(t_i^n \wedge t)}, Y_{t_i^n \wedge t} \right\rangle, \\ (\mathbf{A})_i^6 &= O \left(\left| t_{i+1}^n \wedge t - t_i^n \wedge t \right| \left| M_{t_{i+1}^n \wedge t}^{\text{id}}(\text{id}) - M_{t_i^n \wedge t}^{\text{id}}(\text{id}) \right| \right). \end{aligned}$$

Note that we used the following inequality

$$\int_{t_i^n \wedge t}^{t_{i+1}^n \wedge t} \frac{1}{2} \left\langle g^{(3)} \circ \tau_{-R(t_i^n \wedge t)}, Y_s \right\rangle ds \leq \left\| g^{(3)} \right\|_\infty (t_{i+1}^n \wedge t - t_i^n \wedge t) \quad \mathbb{P}_\nu^{FV} - \text{a.s.}$$

to bound the term $\left[M_{t_{i+1}^n \wedge t}^{\text{id}}(\text{id}) - M_{t_i^n \wedge t}^{\text{id}}(\text{id}) \right] \int_{t_i^n \wedge t}^{t_{i+1}^n \wedge t} \frac{1}{2} \left\langle g^{(3)} \circ \tau_{-R(t_i^n \wedge t)}, Y_s \right\rangle ds$ by $(\mathbf{A})_i^6$. Our goal in the sequel is to write each of these six quantities as sums of finite variation terms, martingale terms and negligible terms and to study the limit of each of them.

5.3.1 Decomposition and study of $(\mathbf{A})_i^1$

Note that, for any $i \in \{0, \dots, p_n - 1\}$,

$$(\mathbf{A})_i^1 = \int_{t_i^n \wedge t}^{t_{i+1}^n \wedge t} \frac{1}{2} \left\langle g'' \circ \tau_{-R(s)}, Y_s \right\rangle ds + \int_{t_i^n \wedge t}^{t_{i+1}^n \wedge t} \frac{1}{2} \left\langle g'' \circ \tau_{-R(t_i^n \wedge t)} - g'' \circ \tau_{-R(s)}, Y_s \right\rangle ds.$$

As a consequence of RIEMANN's sum convergences and using that $s \mapsto \langle g'' \circ \tau_{-R(s)}, Y_s \rangle$ is continuous, we obtain \mathbb{P}_ν^{FV} -a.s., and therefore in probability that

$$\begin{aligned} & \lim_{n \rightarrow +\infty} \sum_{i=0}^{p_n-1} F' \left(\left\langle g \circ \tau_{-R(t_i^n \wedge t)}, Y_{t_i^n \wedge t} \right\rangle \right) \int_{t_i^n \wedge t}^{t_{i+1}^n \wedge t} \frac{1}{2} \langle g'' \circ \tau_{-R(s)}, Y_s \rangle ds \\ &= \int_0^t F' \left(\langle g \circ \tau_{-R(s)}, Y_s \rangle \right) \frac{1}{2} \langle g'' \circ \tau_{-R(s)}, Y_s \rangle ds \\ &= \int_0^t F' \left(\langle g, Z_s \rangle \right) \left\langle \frac{g''}{2}, Z_s \right\rangle ds. \end{aligned}$$

From Lemma A.2 (2), we deduce that, in probability,

$$\lim_{n \rightarrow +\infty} \sum_{i=0}^{p_n-1} F' \left(\left\langle g \circ \tau_{-R(t_i^n \wedge t)}, Y_{t_i^n \wedge t} \right\rangle \right) \int_{t_i^n \wedge t}^{t_{i+1}^n \wedge t} \frac{1}{2} \langle g'' \circ \tau_{-R(t_i^n \wedge t)} - g'' \circ \tau_{-R(s)}, Y_s \rangle ds = 0.$$

5.3.2 Martingale contribution of $(\mathbf{A})_i^2$ and $(\mathbf{A})_i^3$

Note that

$$\sum_{i=0}^{p_n-1} F' \left(\left\langle g \circ \tau_{-R(t_i^n \wedge t)}, Y_{t_i^n \wedge t} \right\rangle \right) (\mathbf{A})_i^3,$$

is a stochastic integral with respect to the square integrable martingale $(M_s^{\text{id}}(\text{id}))_{0 \leq s \leq T}$. Since F' and $s \mapsto \langle g' \circ \tau_{-R(s)}, Y_s \rangle$ are bounded, we deduce that

$$\lim_{n \rightarrow +\infty} \sum_{i=0}^{p_n-1} F' \left(\left\langle g \circ \tau_{-R(t_i^n \wedge t)}, Y_{t_i^n \wedge t} \right\rangle \right) (\mathbf{A})_i^3$$

is \mathbb{P}_ν^{FV} -martingale. The term

$$\mathcal{M}_t^n := \sum_{i=0}^{p_n-1} F' \left(\left\langle g \circ \tau_{-R(t_i^n \wedge t)}, Y_{t_i^n \wedge t} \right\rangle \right) (\mathbf{A})_i^2$$

is a stochastic integral with respect to a martingale which depends on n . However, the same argument as above applies because $(\mathcal{M}_t^n)_{0 \leq t \leq T}$ is bounded in $L^2(\Omega)$, hence uniformly integrable. This can be proved as follows: as F' is bounded and from Lemma 5.2, there exists two constants $C_1, C_2 > 0$ such that

$$\begin{aligned} \mathbb{E} \left([\mathcal{M}_t^n]^2 \right) &= \sum_{i=0}^{p_n-1} \mathbb{E} \left(\left[F' \left(\left\langle g \circ \tau_{-R(t_i^n \wedge t)}, Y_{t_i^n \wedge t} \right\rangle \right) (\mathbf{A})_i^2 \right]^2 \right) \\ &\leq C_1 \sum_{i=0}^{p_n-1} \left\langle M^{\text{id}} \left(g \circ \tau_{-R(t_i^n \wedge t)} \right) - M_{t_i^n \wedge t}^{\text{id}} \left(g \circ \tau_{-R(t_i^n \wedge t)} \right) \right\rangle_{t_{i+1}^n \wedge t} \\ &\leq 4\gamma C_1 C_2 \sum_{i=0}^{p_n-1} (t_{i+1}^n \wedge t - t_i^n \wedge t) \\ &= 4\gamma C_1 C_2 t < \infty. \end{aligned}$$

5.3.3 Contributions of $(\mathbf{A})_i^4$ and $(\mathbf{A})_i^5$

The contribution of the next two terms corresponds to the terms due to the centering effect in the martingale problem (2).

Study of the term $(\mathbf{A})_i^4$. Using Itô's formula and the relation (5), we obtain that

$$(\mathbf{A})_i^4 = (\mathbf{A})_i^{41} + (\mathbf{A})_i^{42} + (\mathbf{A})_i^{43}$$

where

$$\begin{aligned} (\mathbf{A})_i^{41} &= - \int_{t_i^n \wedge t}^{t_{i+1}^n \wedge t} [M_s^{\text{id}}(\text{id}) - M_{t_i^n \wedge t}^{\text{id}}(\text{id})] dM_s^{\text{id}}(g' \circ \tau_{-R}(t_i^n \wedge t)), \\ (\mathbf{A})_i^{42} &= - \int_{t_i^n \wedge t}^{t_{i+1}^n \wedge t} [M_s^{\text{id}}(g' \circ \tau_{-R}(t_i^n \wedge t)) - M_{t_i^n \wedge t}^{\text{id}}(g' \circ \tau_{-R}(t_i^n \wedge t))] dM_s^{\text{id}}(\text{id}), \\ (\mathbf{A})_i^{43} &= -2\gamma \int_{t_i^n \wedge t}^{t_{i+1}^n \wedge t} [\langle \text{id} \times g' \circ \tau_{-R}(t_i^n \wedge t), Y_s \rangle - \langle \text{id}, Y_s \rangle \langle g' \circ \tau_{-R}(t_i^n \wedge t), Y_s \rangle] ds. \end{aligned}$$

Using the same arguments as for $(\mathbf{A})_i^2$, we deduce, in probability, that for $k \in \{41, 42\}$,

$$\lim_{n \rightarrow +\infty} \sum_{i=0}^{p_n-1} F' \left(\langle g \circ \tau_{-R}(t_i^n \wedge t), Y_{t_i^n \wedge t} \rangle \right) (\mathbf{A})_i^k$$

is a \mathbb{P}_ν^{FV} -martingale. Moreover, we decompose the integral of $(\mathbf{A})_i^{43}$ in the following way:

$$(\mathbf{A})_i^{43} = (\mathbf{A})_i^{431} + (\mathbf{A})_i^{432} + (\mathbf{A})_i^{433}$$

where

$$\begin{aligned} (\mathbf{A})_i^{431} &= -2\gamma \int_{t_i^n \wedge t}^{t_{i+1}^n \wedge t} \langle \text{id} \times g' \circ \tau_{-R}(t_i^n \wedge t) - \text{id} \times g' \circ \tau_{-R}(s), Y_s \rangle ds, \\ (\mathbf{A})_i^{432} &= -2\gamma \int_{t_i^n \wedge t}^{t_{i+1}^n \wedge t} \langle \text{id}, Y_s \rangle \langle g' \circ \tau_{-R}(s) - g' \circ \tau_{-R}(t_i^n \wedge t), Y_s \rangle ds, \\ (\mathbf{A})_i^{433} &= -2\gamma \int_{t_i^n \wedge t}^{t_{i+1}^n \wedge t} [\langle \text{id} \times g' \circ \tau_{-R}(s), Y_s \rangle - \langle \text{id}, Y_s \rangle \langle g' \circ \tau_{-R}(s), Y_s \rangle] ds. \end{aligned}$$

Using Lemma A.2, we deduce, in probability, that for $k \in \{431, 432\}$,

$$\lim_{n \rightarrow +\infty} \sum_{i=0}^{p_n-1} F' \left(\langle g \circ \tau_{-R}(t_i^n \wedge t), Y_{t_i^n \wedge t} \rangle \right) (\mathbf{A})_i^k = 0,$$

and we deduce from the convergence of RIEMANN's sums that, \mathbb{P}_ν^{FV} -a.s. and hence in probability,

$$\begin{aligned} &\lim_{n \rightarrow +\infty} \sum_{i=0}^{p_n-1} F' \left(\langle g \circ \tau_{-R}(t_i^n \wedge t), Y_{t_i^n \wedge t} \rangle \right) (\mathbf{A})_i^{433} \\ &= -2\gamma \int_0^t F'(\langle g \circ \tau_{-R}(s), Y_s \rangle) [\langle \text{id} \times g' \circ \tau_{-R}(s), Y_s \rangle - \langle \text{id}, Y_s \rangle \langle g' \circ \tau_{-R}(s), Y_s \rangle] ds \\ &= -2\gamma \int_0^t F'(\langle g, Z_s \rangle) \langle g' \times \text{id}, Z_s \rangle ds. \end{aligned}$$

Study of the term $(\mathbf{A})_i^5$. As $(\mathbf{A})_i^5$ satisfies the following decomposition:

$$(\mathbf{A})_i^5 = \left(\int_{t_i^n \wedge t}^{t_{i+1}^n \wedge t} [M_s^{\text{id}}(\text{id}) - M_{t_i^n \wedge t}^{\text{id}}(\text{id})] dM_s^{\text{id}}(\text{id}) \right. \\ \left. + \gamma \int_{t_i^n \wedge t}^{t_{i+1}^n \wedge t} [\langle \text{id}^2, Y_s \rangle - \langle \text{id}, Y_s \rangle^2] ds \right) \langle g'' \circ \tau_{-R}(t_i^n \wedge t), Y_{t_i^n \wedge t} \rangle$$

and proceeding as for $(\mathbf{A})_i^4$ above, we obtain, in probability, that

$$\lim_{n \rightarrow +\infty} \sum_{i=0}^{p_n-1} F' \left(\langle g \circ \tau_{-R}(t_i^n \wedge t), Y_{t_i^n \wedge t} \rangle \right) (\mathbf{A})_i^5 = \gamma \int_0^T F'(\langle g, Z_{s \wedge t} \rangle) \langle g'', Z_{s \wedge t} \rangle M_2(Z_{s \wedge t}) ds + \text{Mart}_t^{(1)}$$

where $(\text{Mart}_t^{(1)})_{0 \leq t \leq T}$ is a \mathbb{P}_ν^{FV} -martingale.

5.3.4 Study of the error term $(\mathbf{A})_i^6$

From the inequality: for all $x, y \in \mathbb{R}_+$, $xy \leq \frac{2}{3}(x^{\frac{3}{2}} + y^3)$ and Lemma A.3, we deduce, in probability, that

$$\lim_{n \rightarrow +\infty} \sum_{i=0}^{p_n-1} F' \left(\langle g \circ \tau_{-R}(t_i^n \wedge t), Y_{t_i^n \wedge t} \rangle \right) |t_{i+1}^n \wedge t - t_i^n \wedge t| \left| M_{t_{i+1}^n \wedge t}^{\text{id}}(\text{id}) - M_{t_i^n \wedge t}^{\text{id}}(\text{id}) \right| \\ \leq \lim_{n \rightarrow +\infty} \frac{2 \|F'\|_\infty}{3} \left(\sum_{i=0}^{p_n-1} |t_{i+1}^n \wedge t - t_i^n \wedge t|^{\frac{3}{2}} + \sum_{i=0}^{p_n-1} \left| M_{t_{i+1}^n \wedge t}^{\text{id}}(\text{id}) - M_{t_i^n \wedge t}^{\text{id}}(\text{id}) \right|^3 \right) = 0$$

and this completes the proof of Lemma 5.3. \square

5.4 Expressions of terms of (8) involving F''

From the expression (10) of $(\mathbf{B})_i$, we have

$$(\mathbf{B})_i = \sum_{k=1}^5 \frac{1}{2} F'' \left(\langle g \circ \tau_{-R}(t_i^n \wedge t), Y_{t_i^n \wedge t} \rangle \right) (\mathbf{B})_i^k,$$

where

$$(\mathbf{B})_i^1 = \langle g \circ \tau_{-R}(t_i^n \wedge t), Y_{t_{i+1}^n \wedge t} \rangle^2 - \langle g \circ \tau_{-R}(t_i^n \wedge t), Y_{t_i^n \wedge t} \rangle^2, \\ (\mathbf{B})_i^2 = -2 \langle g \circ \tau_{-R}(t_i^n \wedge t), Y_{t_i^n \wedge t} \rangle \left[\langle g \circ \tau_{-R}(t_i^n \wedge t), Y_{t_{i+1}^n \wedge t} \rangle - \langle g \circ \tau_{-R}(t_i^n \wedge t), Y_{t_i^n \wedge t} \rangle \right], \\ (\mathbf{B})_i^3 = [M_{t_{i+1}^n \wedge t}^{\text{id}}(\text{id}) - M_{t_i^n \wedge t}^{\text{id}}(\text{id})]^2 \langle g' \circ \tau_{-R}(t_i^n \wedge t), Y_{t_i^n \wedge t} \rangle^2, \\ (\mathbf{B})_i^4 = - \int_{t_i^n \wedge t}^{t_{i+1}^n \wedge t} \langle g'' \circ \tau_{-R}(t_i^n \wedge t), Y_s \rangle ds [M_{t_{i+1}^n \wedge t}^{\text{id}}(\text{id}) - M_{t_i^n \wedge t}^{\text{id}}(\text{id})] \langle g' \circ \tau_{-R}(t_i^n \wedge t), Y_{t_i^n \wedge t} \rangle, \\ (\mathbf{B})_i^5 = -2 \left[M_{t_{i+1}^n \wedge t}^{\text{id}}(g'' \circ \tau_{-R}(t_i^n \wedge t)) - M_{t_i^n \wedge t}^{\text{id}}(g'' \circ \tau_{-R}(t_i^n \wedge t)) \right] \\ \times [M_{t_{i+1}^n \wedge t}^{\text{id}}(\text{id}) - M_{t_i^n \wedge t}^{\text{id}}(\text{id})] \langle g' \circ \tau_{-R}(t_i^n \wedge t), Y_{t_i^n \wedge t} \rangle.$$

As in Subsection 5.3, we treat each of the previous terms successively to prove the following lemma:

Lemma 5.4. *When the mesh of the subdivision $0 = t_0^n < t_1^n < \dots < t_{p_n}^n = T$ of $[0, T]$ tends to 0 when $n \rightarrow +\infty$, we obtain in probability that*

$$\lim_{n \rightarrow +\infty} \sum_{i=0}^{p_n-1} (\mathbf{B})_i = \gamma \int_0^t F''(\langle g, Z_s \rangle) \left[\langle g^2, Z_s \rangle - \langle g, Z_s \rangle^2 + \langle g', Z_s \rangle^2 M_2(Z_s) \right. \\ \left. - 2 \langle g', Z_s \rangle \langle g \times \text{id}, Z_s \rangle \right] ds + \widehat{\text{Mart}}_t$$

where $(\widehat{\text{Mart}}_t)_{0 \leq t \leq T}$ is a \mathbb{P}_ν^{FV} -martingale.

The proof is similar to Lemma 5.3: we use the martingale problem (4) to write

$$\begin{aligned} (\mathbf{B})_i^1 &= 2 \int_{t_i^n \wedge t}^{t_{i+1}^n \wedge t} \left\langle g \circ \tau_{-R(t_i^n \wedge t)}, Y_s \right\rangle \frac{1}{2} \left\langle g'' \circ \tau_{-R(t_i^n \wedge t)}, Y_s \right\rangle ds \\ &\quad + 2\gamma \int_{t_i^n \wedge t}^{t_{i+1}^n \wedge t} \left[\left\langle g^2 \circ \tau_{-R(t_i^n \wedge t)}, Y_s \right\rangle - \left\langle g \circ \tau_{-R(t_i^n \wedge t)}, Y_s \right\rangle^2 \right] ds \\ &\quad + M_{t_{i+1}^n \wedge t}^{\text{id}^2} \left(g \circ \tau_{-R(t_i^n \wedge t)} \right) - M_{t_i^n \wedge t}^{\text{id}^2} \left(g \circ \tau_{-R(t_i^n \wedge t)} \right), \\ (\mathbf{B})_i^2 &= -2 \left\langle g \circ \tau_{-R(t_i^n \wedge t)}, Y_{t_i^n \wedge t} \right\rangle \int_{t_i \wedge t}^{t_{i+1}^n \wedge t} \frac{1}{2} \left\langle g'' \circ \tau_{-R(t_i^n \wedge t)}, Y_s \right\rangle ds \\ &\quad - 2 \left\langle g \circ \tau_{-R(t_i^n \wedge t)}, Y_{t_i^n \wedge t} \right\rangle \left[M_{t_{i+1}^n \wedge t}^{\text{id}} \left(g \circ \tau_{-R(t_i^n \wedge t)} \right) - M_{t_i^n \wedge t}^{\text{id}} \left(g \circ \tau_{-R(t_i^n \wedge t)} \right) \right], \end{aligned}$$

and we obtain that, in probability,

$$\begin{aligned} \lim_{n \rightarrow +\infty} \sum_{i=0}^{p_n-1} F'' \left(\left\langle g \circ \tau_{-R(t_i^n \wedge t)}, Y_{t_i^n \wedge t} \right\rangle \right) (\mathbf{B})_i^1 \\ = \gamma \int_0^t F''(\langle g, Z_s \rangle) \left\{ \langle g, Z_s \rangle \left\langle \frac{g''}{2}, Z_s \right\rangle + \gamma \left[\langle g^2, Z_s \rangle - \langle g, Z_s \rangle^2 \right] \right\} ds + \widehat{\text{Mart}}_t^{(1)}, \\ \lim_{n \rightarrow +\infty} \sum_{i=0}^{p_n-1} F'' \left(\left\langle g \circ \tau_{-R(t_i^n \wedge t)}, Y_{t_i^n \wedge t} \right\rangle \right) (\mathbf{B})_i^2 \\ = - \int_0^t F''(\langle g, Z_s \rangle) \langle g, Z_s \rangle \left\langle \frac{g''}{2}, Z_s \right\rangle ds + \widehat{\text{Mart}}_t^{(2)}, \\ \lim_{n \rightarrow +\infty} \sum_{i=0}^{p_n-1} F'' \left(\left\langle g \circ \tau_{-R(t_i^n \wedge t)}, Y_{t_i^n \wedge t} \right\rangle \right) \left((\mathbf{B})_i^3 + (\mathbf{B})_i^4 + (\mathbf{B})_i^5 \right) \\ = \gamma \int_0^t F''(\langle g, Z_s \rangle) \left(\langle g', Z_s \rangle^2 M_2(Z_s) + \langle g', Z_s \rangle \langle g \times \text{id}, Z_s \rangle \right) ds + \widehat{\text{Mart}}_t^{(3)}, \end{aligned}$$

where $(\widehat{\text{Mart}}_t^{(j)})_{0 \leq t \leq T}$, $j \in \{1, 2, 3\}$ are \mathbb{P}_ν^{FV} -martingales.

5.5 Error terms

In this subsection, we examine the different error terms involved in the approximation (8). From Lemma A.3, we deduce that, in probability,

$$\lim_{n \rightarrow +\infty} \sum_{i=0}^{p_n-1} \left| \langle \text{id}, Y_{t_{i+1}^n \wedge t} - Y_{t_i^n \wedge t} \rangle \right|^3 = \lim_{n \rightarrow +\infty} \sum_{i=0}^{p_n-1} \left| M_{t_{i+1}^n \wedge t}^{\text{id}}(\text{id}) - M_{t_i^n \wedge t}^{\text{id}}(\text{id}) \right|^3 = 0.$$

Using the relations (34) and (35), we deduce for any $k \in \{0, 1, 2\}$,

$$\begin{aligned} & \sum_{i=0}^{p_n-1} \left| \left\langle g^{(k)} \circ \tau_{-\langle \text{id}, Y_{t_i^n \wedge t} \rangle}, Y_{t_{i+1}^n \wedge t} - Y_{t_i^n \wedge t} \right\rangle \right|^3 \\ & \leq \max \left(\frac{1}{2} \|g^{(k)}\|_\infty^3, 4 \right) \sum_{i=0}^{p_n-1} \left(|t_{i+1}^n \wedge t - t_i^n \wedge t|^3 \right. \\ & \quad \left. + \left| M_{t_{i+1}^n \wedge t}^{\text{id}} \left(g^{(k)} \circ \tau_{-R(t_i^n \wedge t)} \right) - M_{t_i^n \wedge t}^{\text{id}} \left(g^{(k)} \circ \tau_{-R(t_i^n \wedge t)} \right) \right|^3 \right). \end{aligned}$$

Hence,

$$\lim_{n \rightarrow +\infty} \sum_{i=0}^{p_n-1} \left| \left\langle g^{(k)} \circ \tau_{-\langle \text{id}, Y_{t_i^n \wedge t} \rangle}, Y_{t_{i+1}^n \wedge t} - Y_{t_i^n \wedge t} \right\rangle \right|^3 = 0$$

in probability. Combining all the previous results, we deduce that (7) is a martingale for all $F, g \in \mathcal{C}_b^4(\mathbb{R}, \mathbb{R})$.

5.6 Extension to test functions $F \in \mathcal{C}^2(\mathbb{R}, \mathbb{R})$ and $g \in \mathcal{C}_b^2(\mathbb{R}, \mathbb{R})$

For all $g \in \mathcal{C}_b^2(\mathbb{R}, \mathbb{R})$ and for all $t \geq 0$, we have $\langle g, Y_t \rangle \in [-\|g\|_\infty, \|g\|_\infty]$, so we can assume without loss of generality that $F \in \mathcal{C}_b^2(\mathbb{R}, \mathbb{R})$ in the martingale problem (2) with X_t replaced by Z_t . Let $F, g \in \mathcal{C}_b^2(\mathbb{R}, \mathbb{R})$. Then, by density arguments, there exists $(F_n)_{n \in \mathbb{N}}, (g_n)_{n \in \mathbb{N}} \in \mathcal{C}_b^4(\mathbb{R}, \mathbb{R})^{\mathbb{N}}$ such that for all $t \geq 0$, for all $i \in \{0, 1, 2\}$, we have \mathbb{P}_μ -a.s.

$$g_n^{(i)} \xrightarrow[n \rightarrow +\infty]{\|\cdot\|_\infty} g^{(i)} \quad \text{and} \quad F_n^{(i)} \xrightarrow[n \rightarrow +\infty]{\|\cdot\|_\infty} F^{(i)}. \quad (36)$$

For all $n \in \mathbb{N}$, for all $t \geq 0$, $\widehat{M}_t^{F_n}(g_n)$ given by the martingale problem (2) is a \mathbb{P}_μ -martingale. Let $T > 0$. Note that, there exists a constant C for all $n \in \mathbb{N}$, for all $t \in [0, T]$ such that

$$\left| \widehat{M}_t^{F_n}(g_n) - \widehat{M}_t^F(g) \right| \leq C \left(1 + \int_0^T M_2(Z_s) ds \right).$$

Thanks to Proposition 2.11, (36) and the dominated convergence theorem, we have for all $t \in [0, T]$,

$$\lim_{n \rightarrow +\infty} \mathbb{E} \left(\left| \widehat{M}_t^{F_n}(g_n) - \widehat{M}_t^F(g) \right| \right) = 0,$$

and $\widehat{M}_t^F(g) \in L^1(\widetilde{\Omega})$. Then, using the dominated convergence theorem for conditional expectation, we obtain that $(\widehat{M}_t^F(g))_{0 \leq t \leq T}$ is a \mathbb{P}_μ -martingale.

5.7 L^2 -martingale and quadratic variation

As $(\widehat{M}_t^F(g))_{0 \leq t \leq T}$ is a \mathbb{P}_μ -martingale for $F \in \mathcal{C}^2(\mathbb{R}, \mathbb{R})$ and $g \in \mathcal{C}_b^2(\mathbb{R}, \mathbb{R})$ we deduce that $(\widehat{M}_t^F(g)^2 - \langle \widehat{M}^F(g) \rangle_t)_{0 \leq t \leq T}$ is a \mathbb{P}_μ -local martingale. In consequence, there exists an increasing sequence of stopping times $(\tau_n)_{n \in \mathbb{N}}$ satisfying $\lim_{n \rightarrow +\infty} \tau_n = +\infty$ such that for all $n \in \mathbb{N}$,

$$\mathbb{E}(\widehat{M}_{t \wedge \tau_n}^F(g)^2) = \mathbb{E}(\langle \widehat{M}^F(g) \rangle_{t \wedge \tau_n}).$$

We apply ITÔ's formula to compute $F^2(\langle g, X_{t \wedge \tau_n} \rangle)$ from DOOB's semi-martingale decomposition of $F(\langle g, X_{t \wedge \tau_n} \rangle)$ and apply the martingale problem (2) to test functions F^2 and g to deduce (3) at time $t \wedge \tau_n$. By FATOU's lemma, letting $n \rightarrow +\infty$, we deduce that

$$\mathbb{E}(\widehat{M}_t^F(g)^2) \leq \mathbb{E}(\langle \widehat{M}^F(g) \rangle_t) < \infty.$$

This ends the proof of Theorem 2.3.

5.8 Technical result for Lemma 5.2

As the filtered probability space $(\Omega, \mathcal{F}, (\mathcal{F}_t)_{t \geq 0})$ is Polish (Subsection 2.1), we deduce from [29, Theorem 3.18] there exists, for all $\nu \in \mathcal{M}_1(\mathbb{R})$, an unique family $(\mathbb{Q}_\omega)_{\omega \in \Omega}$ of regular conditional probability of \mathbb{P}_ν^{FV} given \mathcal{F}_{t^*} and a \mathbb{P}_ν^{FV} -null event $N \in \mathcal{F}_{t^*}$ such that for all $\omega \in \Omega \setminus N$,

$$\mathbb{Q}_\omega \left(\left\{ \tilde{\omega} \in \Omega \mid \tilde{\omega}_{t^*} = \omega_{t^*} \right\} \right) = 1. \quad (37)$$

The following Theorem 5.5 ensures that time shifts of regular conditional probabilities of \mathbb{P}_ν^{FV} remain solutions to the FLEMING-VIOT martingale problem (4). The proof of this result is given hereafter and is based on the proof of [29, Lemma 4.19]. We introduce, for $\omega \in \Omega$, the time-shift operator θ defined by

$$[\theta_s \omega]_t := \omega_{s+t}, \quad 0 \leq t < +\infty, \quad s \geq 0.$$

Theorem 5.5. *Let $t^* \in \mathbb{R}_+$ be a deterministic time. Then there exists a \mathbb{P}_ν^{FV} -null event $N \in \mathcal{F}_{t^*}$ such that, for every $\omega \in \Omega \setminus N$, the probability measure*

$$\mathbb{P}_\omega(d\tilde{\omega}) := \theta_{t^* \#} \mathbb{Q}_\omega(d\tilde{\omega}) \quad (38)$$

solves the martingale problem (4) with $\nu := \omega_{t^}$.*

Proof. Step 0. Preliminary results. We denote by $\mathcal{C}_K^2(\mathbb{R}, \mathbb{R})$ the space of real functions of class $\mathcal{C}^2(\mathbb{R}, \mathbb{R})$ with compact support. It is well-known that the formulation of the martingale problem (4) for $F, g \in \mathcal{C}_b^2(\mathbb{R}, \mathbb{R})$ is equivalent to the one for $F, g \in \mathcal{C}_K^2(\mathbb{R}, \mathbb{R})$ [9]. The space $\mathcal{C}_K^2(\mathbb{R}, \mathbb{R})$ equipped with the norm $\|f\|_{W_0^{2,\infty}} := \|f\|_\infty + \|f'\|_\infty + \|f''\|_\infty$ is separable. So, we can choose a dense countable family $\mathcal{B} \subset \mathcal{C}_K^2(\mathbb{R}, \mathbb{R})$, for the topology associated to the norm, that is to say

$$\forall F, g \in \mathcal{C}_K^2(\mathbb{R}, \mathbb{R}), \quad \exists (F_n)_{n \in \mathbb{N}}, (g_n)_{n \in \mathbb{N}} \in \mathcal{B}^{\mathbb{N}}, \quad F_n \xrightarrow[n \rightarrow +\infty]{\|\cdot\|_{W_0^{2,\infty}}} F, \quad g_n \xrightarrow[n \rightarrow +\infty]{\|\cdot\|_{W_0^{2,\infty}}} g.$$

Hence, if we denote by \mathcal{L}_{FV} the generator of the original FLEMING-VIOT process, we deduce that $\mathcal{L}_{FV}(F_n)_{g_n} \xrightarrow[n \rightarrow +\infty]{\|\cdot\|_\infty} \mathcal{L}_{FV}F_g$.

Step 1. Reformulation of the goal. Let $\nu \in \mathcal{M}_1(\mathbb{R})$. From (37), it follows that $\mathbb{P}_\omega(\tilde{\omega}_0 = \nu) = 1$ is satisfied with $\nu := \omega_{t^*}$. The rest of the proof is devoted to construct a \mathbb{P}_ν^{FV} -null event N_4 such that

$$\mathbb{E}_{\mathbb{P}_\nu^{FV}} \left[F_g(\omega_t) - F_g(\omega_s) - \int_s^t \mathcal{L}_{FV}F_g(\omega_r) dr \middle| \mathcal{F}_s \right] = 0, \quad \mathbb{P}_\nu^{FV}\text{-a.s.}$$

is satisfied for all $\omega \in \Omega \setminus N_4$. This means that for all $0 \leq s < t < \infty$, $A \in \mathcal{F}_s$, $F, g \in \mathcal{C}_K^2(\mathbb{R}, \mathbb{R})$,

$$\forall \omega \in \Omega \setminus N_4, \quad \int_\Omega \left[M_t^{Fg}(\tilde{\omega}) - M_s^{Fg}(\tilde{\omega}) \right] \mathbf{1}_A(\tilde{\omega}) \mathbb{P}_\omega(d\tilde{\omega}) = 0, \quad (39)$$

where

$$M_t^{Fg}(\tilde{\omega}) := F_g(\tilde{\omega}_t) - F_g(\tilde{\omega}_0) - \int_0^t \mathcal{L}_{FV}F_g(\tilde{\omega}_r) dr.$$

Let $\omega \in \Omega$, $0 \leq s < t < \infty$, $A \in \mathcal{F}_s$, $F, g \in \mathcal{C}_K^2(\mathbb{R}, \mathbb{R})$ be fixed.

Step 2. Property (39) satisfied except on a \mathbb{P}_ν^{FV} -null event $N_1(s, t, A, F, g) \in \mathcal{F}_{t^*}$. As $\mathcal{L}_{FV}F_g \in \mathcal{C}_b^2(\mathbb{R}, \mathbb{R})$, the random variable $M_t^{Fg} - M_s^{Fg}$ is bounded. Note that,

$$\begin{aligned} \int_\Omega \left[M_t^{Fg}(\tilde{\omega}) - M_s^{Fg}(\tilde{\omega}) \right] \mathbf{1}_A(\tilde{\omega}) \mathbb{P}_\omega(d\tilde{\omega}) &= \mathbb{E}_{\mathbb{Q}_\omega(d\tilde{\omega})} \left(\left[M_t^{Fg} - M_s^{Fg} \right] \circ \theta_{t^*}(\tilde{\omega}) \mathbf{1}_{\theta_{t^*}^{-1}A}(\tilde{\omega}) \right) \\ &= \mathbb{E}_{\mathbb{P}_\nu^{FV}} \left(\left[M_t^{Fg} - M_s^{Fg} \right] \circ \theta_{t^*} \mathbf{1}_{\theta_{t^*}^{-1}A} \middle| \mathcal{F}_{t^*} \right) (\omega) \\ &= \mathbb{E}_{\mathbb{P}_\nu^{FV}} \left[\mathbb{E}_{\mathbb{P}_\nu^{FV}} \left(\left[M_t^{Fg} - M_s^{Fg} \right] \circ \theta_{t^*} \mathbf{1}_{\theta_{t^*}^{-1}A} \middle| \mathcal{F}_{t^*+s} \right) \middle| \mathcal{F}_{t^*} \right] (\omega) \\ &= \mathbb{E}_{\mathbb{P}_\nu^{FV}} \left[\mathbf{1}_{\theta_{t^*}^{-1}A} \mathbb{E}_{\mathbb{P}_\nu^{FV}} \left(\left[M_t^{Fg} - M_s^{Fg} \right] \circ \theta_{t^*} \middle| \mathcal{F}_{t^*+s} \right) \middle| \mathcal{F}_{t^*} \right] (\omega) \\ &= 0, \end{aligned}$$

where the last equality follows from martingale property (4). This chain of equalities shows that the random variable $\omega \mapsto \int_A \left[M_t^{Fg}(\tilde{\omega}) - M_s^{Fg}(\tilde{\omega}) \right] \mathbb{P}_\omega(d\tilde{\omega})$ is null except on a \mathbb{P}_ν^{FV} -null event $N_1(s, t, A, F, g) \in \mathcal{F}_{t^*}$ which depends on s, t, A, F and g .

Step 3. Property (39) satisfied except on a \mathbb{P}_ν^{FV} -null event $N_2(s, t, F, g) \in \mathcal{F}_{t^*}$. We consider a countable subcollection \mathcal{E} of \mathcal{F}_s which generates \mathcal{F}_s [29, Definition 3.17] and a \mathbb{P}_ν -null event $N_2(s, t, F, g) \in \mathcal{F}_{t^*}$ such that for $\omega \in \Omega \setminus N_2(s, t, F, g)$,

$$\forall A \in \mathcal{E}, \quad \int_A \left[M_t^{Fg}(\tilde{\omega}) - M_s^{Fg}(\tilde{\omega}) \right] \mathbb{P}_\omega(d\tilde{\omega}) = 0.$$

Therefore, the two measures

$$v_\omega^+(A) := \int_A [M_t^{Fg} - M_s^{Fg}]^+ (\tilde{\omega}) \mathbb{P}_\omega (d\tilde{\omega}) \quad \text{and} \quad v_\omega^-(A) := \int_A [M_t^{Fg} - M_s^{Fg}]^- (\tilde{\omega}) \mathbb{P}_\omega (d\tilde{\omega}),$$

coincide on \mathcal{E} , hence on \mathcal{F}_s . Therefore, for $\omega \in \Omega \setminus N_2(s, t, F, g)$, we have proved that for all $A \in \mathcal{F}_s$, $\mathbb{E}_{\mathbb{P}_\omega} \left(\mathbf{1}_A [M_t^{Fg} - M_s^{Fg}] \right) = 0$.

Step 4. Property (39) satisfied except on a \mathbb{P}_ν^{FV} -null event $N_3(F, g) \in \mathcal{F}_{t^*}$. We may set now, the \mathbb{P}_ν^{FV} -null event

$$N_3(F, g) := \bigcup_{\substack{s, t \in \mathbb{Q} \\ 0 \leq s < t < \infty}} N_2(s, t, F, g).$$

Due to the boundedness and continuity of $t \mapsto M_t^{Fg}$, it follows from the dominated convergence theorem that for $\omega \in \Omega \setminus N_3(F, g)$

$$\forall s < t, \forall A \in \mathcal{F}_s, \quad \mathbb{E}_{\mathbb{P}_\omega} \left(\mathbf{1}_A [M_t^{Fg} - M_s^{Fg}] \right) = 0,$$

in other words, for all $\omega \in \Omega \setminus N_3(F, g)$, $(M_t^{Fg}(\tilde{\omega}))_{t \geq 0}$ is a $(\mathcal{F}_s, \mathbb{P}_\omega(d\tilde{\omega}))$ -martingale.

Step 5. Conclusion. Now we define the \mathbb{P}_ν^{FV} -null event

$$N_4 := \bigcup_{F, g \in \mathcal{B}} N_3(F, g)$$

From the Step 4, we have for all $s \leq t$,

$$\forall \omega \in \Omega \setminus N_4, \quad \forall A \in \mathcal{F}_s, \quad \forall F, g \in \mathcal{B}, \quad \mathbb{E}_{\mathbb{P}_\omega} \left[\mathbf{1}_A (M_t^{Fg} - M_s^{Fg}) \right] = 0.$$

From Step 0, for all $F, g \in \mathcal{C}_K^2(\mathbb{R}, \mathbb{R})$, there exist two sequences $(F_n)_{n \in \mathbb{N}}, (g_n)_{n \in \mathbb{N}} \in \mathcal{B}^{\mathbb{N}}$ such that

$$F_n \xrightarrow[n \rightarrow +\infty]{\|\cdot\|_{W_0^{2,\infty}}} F, \quad g_n \xrightarrow[n \rightarrow +\infty]{\|\cdot\|_{W_0^{2,\infty}}} g, \quad \text{and} \quad \mathcal{L}_{FV}(F_n)_{g_n} \xrightarrow[n \rightarrow +\infty]{\|\cdot\|_\infty} \mathcal{A}Fg.$$

By the dominated convergence theorem, we deduce that for all $\omega \in \Omega$, $s \leq t$, and $A \in \mathcal{F}_s$,

$$\mathbb{E}_{\mathbb{P}_\omega} \left[\mathbf{1}_A (M_t^{Fg} - M_s^{Fg}) \right] = \lim_{n \rightarrow +\infty} \mathbb{E}_{\mathbb{P}_\omega} \left[\mathbf{1}_A (M_t^{(F_n)_{g_n}} - M_s^{(F_n)_{g_n}}) \right] = 0.$$

which concludes the proof. \square

5.9 Proof of Lemma 5.2

By abuse of notation, we note $h(\omega_{|[0, t^*]}) = h(\omega)$. We want to prove that for all $0 \leq s \leq t$, for all \mathcal{F}_s -measurable bounded random variable Z ,

$$\mathbb{E}_{\mathbb{P}_\nu^{FV}(d\tilde{\omega})} ([\mathcal{M}_t(\tilde{\omega}) - \mathcal{M}_s(\tilde{\omega})] Z(\tilde{\omega})) = 0.$$

Using [28, Definition 3.2 (iii)] we deduce that

$$\mathbb{E}_{\mathbb{P}_\nu^{FV}(\mathrm{d}\tilde{\omega})}([\mathcal{M}_t(\tilde{\omega}) - \mathcal{M}_s(\tilde{\omega})] Z(\tilde{\omega})) = \mathbb{E}_{\mathbb{P}_\nu(\mathrm{d}\omega)}[\mathbb{E}_{\mathbb{Q}_\omega(\mathrm{d}\tilde{\omega})}([\mathcal{M}_t(\tilde{\omega}) - \mathcal{M}_s(\tilde{\omega})] Z(\tilde{\omega}))].$$

Thus, it is sufficient to prove that for \mathbb{P}_ν^{FV} -almost every $\omega \in \Omega$, $(\mathcal{M}_t(\tilde{\omega}))_{0 \leq t \leq T}$ is a $\mathbb{Q}_\omega(\mathrm{d}\tilde{\omega})$ -martingale and this is what we propose to establish in the rest of this proof.

For fixed ω , the function $h(\omega) \in \mathcal{C}_b^2(\mathbb{R}, \mathbb{R})$ can be considered as deterministic. We deduce from Theorem 5.5 that there exists a \mathbb{P}_ν^{FV} -null event $N \in \mathcal{F}_{t^*}$ such that for all $\omega \in \Omega \setminus N$, $(M_t^{\mathrm{id}}(h(\omega))(\tilde{\omega}))_{0 \leq t \leq T}$ is a $\mathbb{P}_\omega(\mathrm{d}\tilde{\omega})$ -martingale. We deduce from [29, Theorem 3.18] that \mathbb{P}_ν^{FV} -almost every $\omega \in \Omega$,

$$\tilde{\omega}|_{[0, t^*]} = \omega|_{[0, t^*]}, \quad \mathbb{Q}_\omega(\mathrm{d}\tilde{\omega})\text{-a.s.} \quad (40)$$

This implies that, $\mathbb{Q}_\omega(\mathrm{d}\tilde{\omega})$ -almost surely,

$$\begin{aligned} \mathcal{M}_t(\tilde{\omega}) &= M_t^{\mathrm{id}}(h(\omega))(\tilde{\omega}) - M_{t \wedge t^*}^{\mathrm{id}}(h(\omega))(\tilde{\omega}) = \begin{cases} M_{t-t^*}^{\mathrm{id}}(h(\omega))(\theta_{t^*}(\tilde{\omega})) & \text{if } t > t^* \\ 0 & \text{if } t \leq t^* \end{cases} \\ &= M_{(t-t^*)^+}^{\mathrm{id}}(h(\omega))(\theta_{t^*}(\tilde{\omega})). \end{aligned}$$

Let $n \in \mathbb{N}^*$ and $0 \leq s \leq T$. To prove the martingale property for all \mathcal{F}_s -measurable bounded random variable Z , it is sufficient to prove it on elementary events. Then, we consider a random variable Z of the form

$$Z(\omega) := \mathbb{1}_{\{\omega_{t_1} \in \Gamma_1, \dots, \omega_{t_n} \in \Gamma_n\}}$$

where for all $i \in \{1, \dots, n\}$, $t_i \leq s$ and $\Gamma_i \subset \mathcal{M}_1(\mathbb{R})$ measurable. We define

$$\tilde{Z}(\omega, \tilde{\omega}) := \mathbb{1}_{\{\omega_{t_i} \in \Gamma_i, \forall i \in \{1, \dots, n\} \text{ such that } t_i \leq t^*\}} \mathbb{1}_{\{\tilde{\omega}_{t_j} \in \Gamma_j, \forall j \in \{1, \dots, n\} \text{ such that } t_j > t^*\}}.$$

By (40), $\tilde{Z}(\omega, \tilde{\omega}) = Z(\omega)$, $\mathbb{Q}_\omega(\mathrm{d}\tilde{\omega})$ -a.s. Therefore, for \mathbb{P}_ν^{FV} -almost every $\omega \in \Omega$,

$$\begin{aligned} &\mathbb{E}_{\mathbb{Q}_\omega}([\mathcal{M}_t - \mathcal{M}_s] Z) \\ &= \mathbb{E}_{\mathbb{Q}_\omega(\mathrm{d}\tilde{\omega})} \left(\left[M_{(t-t^*)^+}^{\mathrm{id}}(h(\omega))(\theta_{t^*}(\tilde{\omega})) - M_{(s-t^*)^+}^{\mathrm{id}}(h(\omega))(\theta_{t^*}(\tilde{\omega})) \right] \tilde{Z}(\omega, \tilde{\omega}) \right) \\ &= \mathbb{1}_{\{\omega_{t_i} \in \Gamma_i, \forall i \in \{1, \dots, n\} \text{ such that } t_i \leq t^*\}} \times \\ &\quad \mathbb{E}_{\mathbb{Q}_\omega(\mathrm{d}\tilde{\omega})} \left(\left[M_{t-t^*}^{\mathrm{id}}(h(\omega))(\theta_{t^*}(\tilde{\omega})) - M_{s-t^*}^{\mathrm{id}}(h(\omega))(\theta_{t^*}(\tilde{\omega})) \right] \right. \\ &\quad \left. \times \mathbb{1}_{\{[\theta_{t^*}(\tilde{\omega})]_{t_j-t^*} \in \Gamma_j, \forall j \in \{1, \dots, n\} \text{ such that } t_j > t^*\}} \right) \\ &\stackrel{(38)}{=} \mathbb{1}_{\{\omega_{t_i} \in \Gamma_i, \forall i \in \{1, \dots, n\} \text{ such that } t_i \leq t^*\}} \mathbb{E}_{\mathbb{P}_\omega(\mathrm{d}\tilde{\omega})} \left(\left[M_{t-t^*}^{\mathrm{id}}(h(\omega))(\tilde{\omega}) - M_{s-t^*}^{\mathrm{id}}(h(\omega))(\tilde{\omega}) \right] \right. \\ &\quad \left. \times \mathbb{1}_{\{\hat{\omega}_{t_j-t^*} \in \Gamma_j, \forall j \in \{1, \dots, n\} \text{ such that } t_j > t^*\}} \right) \\ &= 0, \end{aligned}$$

using that $(M_{t-t^*}^{\text{id}}(h(\omega))(\tilde{\omega}))_{t^* \leq t \leq T+t^*}$ is a $\mathbb{P}_\omega(d\tilde{\omega})$ -martingale if the internal indicator is non zero. Thus, for \mathbb{P}_ν^{FV} -almost every $\omega \in \Omega$, $(\mathcal{M}_t(\tilde{\omega}))_{0 \leq t \leq T}$ is a $\mathbb{Q}_\omega(d\tilde{\omega})$ -martingale which completes the first part of this proof. In similar way, we can prove

$$M_t^{\text{id}^2}(h(\tilde{\omega}))(\tilde{\omega}) - M_{t \wedge t^*}^{\text{id}^2}(h(\tilde{\omega}))(\tilde{\omega})$$

is a \mathbb{P}_ν^{FV} -martingale. Applying ITÔ's formula to compute $\langle h(\tilde{\omega}_t), \tilde{\omega}_t \rangle^2$ and comparing it to the previous result, we obtain the announced result. \square

6 Proof of the results of Section 3

6.1 Study of a semi-group

In this subsection, we devote a specific study to the semi-group $(T^{(n)}(t))_{t \geq 0}$ generated by the operator $B^{(n)}$. In the first subsubsection, we provide an explicit expression of $(t, x) \mapsto T^{(n)}(t)f(x)$ and prove that it is a strong solution to the semi-group PDE associated with $B^{(n)}$, by means of FEYNMAN-KAC's formula. With the aim of subsequently obtaining fairly fine bounds on this operator (see Corollary 6.2), we give all the necessary details. In the second subsubsection, we give a MILD formulation of the martingale problem (15) using the semigroup $(T^{(n)}(t))_{t \geq 0}$ in Proposition 6.3.

6.1.1 Construction of the semi-group

Recall that we denote by $\mathbf{1} \in \mathbb{R}^n$, the vector whose coordinates are all 1. For any real vector-valued function f and g of $L^1(\mathbb{R}^n)$, we denote by $(f * g)(x) := \int_{\mathbb{R}^n} f(t)g(x-t)dt$ the convolution product of f and g . For any function f whose second partial derivatives exist, we denote by $\text{Hess}(f) := (\partial_{ij}^2 f)_{1 \leq i, j \leq n}$ the Hessian matrix of f . We denote by $\mathcal{C}_b^{1,2}(\mathbb{R}_+ \times \mathbb{R}^n, \mathbb{R})$ the space of real functions on $\mathbb{R}_+ \times \mathbb{R}^n$ of class $\mathcal{C}^1(\mathbb{R}_+, \mathbb{R})$ with respect to the first variable and of class $\mathcal{C}_b^2(\mathbb{R}^n, \mathbb{R})$ to the second variable.

Theorem 6.1. *The family of operators $(T^{(n)}(t))_{t \geq 0}$ defined as:*

$$\begin{aligned} \forall t > 0, \forall x \in \mathbb{R}^n, \quad T^{(n)}(t)f(x) &:= \int_{\mathbb{R}^n} f(u)g_{t,x}^X(u)du, \\ \forall x \in \mathbb{R}^n, \quad T^{(n)}(0)f(x) &:= f(x), \end{aligned} \tag{41}$$

where $g_{t,x}^X$ is a Gaussian density of $\mathcal{N}^{(n)}(m_{t,x}, \Sigma_t)$ where $\Sigma_t := P\sigma_t P^{-1}$ and $m_{t,x} := P\mu_{t,P^{-1}x} = x - \frac{(1-\exp(-2\gamma nt))}{n}(x \cdot \mathbf{1})\mathbf{1}$ with

$$\mu_{t,y} := \begin{pmatrix} y_1 \exp(-2\gamma nt) \\ y_2 \\ \vdots \\ y_n \end{pmatrix} \quad \text{and} \quad \sigma_t := \begin{pmatrix} e_4(t) & 0 & \dots & \dots & 0 \\ 0 & t & 0 & \dots & 0 \\ \vdots & 0 & \ddots & \ddots & \vdots \\ \vdots & \vdots & \ddots & \ddots & 0 \\ 0 & 0 & \dots & 0 & t \end{pmatrix},$$

where $e_4(t) := \frac{1 - \exp(-4\gamma nt)}{4\gamma n}$ and P is an explicit change of orthonormal basis matrix defined in the proof below, is a semi-group of bounded operators on $L^\infty(\mathbb{R}^n)$. In addition, for all $f \in \mathcal{C}_b^2(\mathbb{R}^n, \mathbb{R})$,

(1) The application $(t, x) \mapsto T^{(n)}(t)f(x)$ is of class $\mathcal{C}^{1,2}(\mathbb{R}_+ \times \mathbb{R}^n, \mathbb{R})$ and is a strong solution of the PDE

$$\forall t \geq 0, \forall x \in \mathbb{R}^n, \quad \partial_t u(t, x) = \frac{1}{2} \Delta u(t, x) - 2\gamma (\nabla u(t, x) \cdot \mathbf{1})(x \cdot \mathbf{1}) \quad (42)$$

$$\forall x \in \mathbb{R}^n, \quad u(0, x) = f(x), \quad (43)$$

and

$$(2) \quad \nabla T^{(n)}(t)f(x) = (\partial_{x_i} m_{t,x} \cdot (\nabla f * g_{t,0}^X)(m_{t,x}))_{1 \leq i \leq n}^t$$

$$(3) \quad \forall i, j \in \{1, \dots, n\}, \quad \partial_{x_i x_j}^2 T^{(n)}(t)f(x) = (\partial_{x_j} m_{t,x})^t [(f * \text{Hess}(g_{t,0}^X))(m_{t,x}) \partial_{x_i} m_{t,x}]$$

where $\partial_{x_i} m_{t,x} = \epsilon_i - \frac{1 - \exp(-2\gamma nt)}{n} \mathbf{1}$ with $(\epsilon_1, \dots, \epsilon_n)$ the canonical basis of \mathbb{R}^n .

As we will see in the proof, everything follows quite directly from the FEYNMAN-KAC formula, except the fact that $(t, x) \mapsto T^{(n)}(t)f(x)$ is a strong solution of the PDE up to time $t = 0$. This technical point will be useful for the MILD formulation and this is why we make a detailed proof.

Proof. In view of the operator $B^{(n)}$ given by (14), it is natural to define the semi-group $T^{(n)}(t)$ using the formula of FEYNMAN-KAC: for any $f \in \mathcal{C}_b^2(\mathbb{R}^n, \mathbb{R})$,

$$T^{(n)}(t)f(x) := \mathbb{E}_x f(X_t)$$

where $(X_t)_{t \geq 0}$ is solution to the following SDE:

$$X_0 = x, \quad dX_t = dB_t - 2\gamma (X_t \cdot \mathbf{1}) \mathbf{1} dt, \quad X_t \in \mathbb{R}^n, \quad t > 0 \quad (44)$$

where $(B_t)_{t \geq 0}$ is a n -standard Brownian motion and $x \in \mathbb{R}^n$.

In Step 1, we check that this definition of $T^{(n)}(t)$ coincides with the one given in the statement of Theorem 6.1. In Step 2, we verify that $(x, t) \mapsto \mathbb{E}_x f(X_t)$ is indeed a solution of the PDE (42) for all $t > 0$. In Step 3, we treat the case $t = 0$. In Step 4, we prove the announced expressions of the derivatives of $T^{(n)}(t)f(x)$.

Step 1. Change of basis in the SDE (44). We consider the orthonormal basis (v_1, \dots, v_n) of \mathbb{R}^n defined by $v_1 := \frac{1}{\sqrt{n}}(1 \dots 1)^t$ and for $2 \leq i \leq n$,

$$v_i := \sqrt{\frac{i-1}{i}} \left(\underbrace{\frac{1}{i-1}, \dots, \frac{1}{i-1}}_{i-1 \text{ terms}}, -1, 0, \dots, 0 \right)^t.$$

We denote by P the change of basis matrix from the canonical basis to the orthonormal basis (v_1, \dots, v_n) . We define for all $t \geq 0$, $Z_t = P^{-1}X_t$, i.e. $Z_t := (Z_t^{(1)}, \dots, Z_t^{(n)})$ where for all $i \in \{1, \dots, n\}$, $Z_t^{(i)} := (X_t \cdot v_i)$. It is standard to check that $W_t := (W_t^{(1)}, \dots, W_t^{(n)})$ where for all $i \in \{1, \dots, n\}$, $W_t^{(i)} := (B_t \cdot v_i)$ is a n -standard Brownian motion and that $(Z_t)_{t \geq 0}$ is solution to the SDE

$$Z_0 = y = P^{-1}x, \quad \begin{cases} dZ_t^{(1)} = dW_t^{(1)} - 2\gamma n Z_t^{(1)} dt, \\ dZ_t^{(j)} = dW_t^{(j)}, \end{cases} \quad j \in \{2, \dots, n\}. \quad (45)$$

All coordinates in (45) are independent and solve a one-dimensional SDE whose solution is explicit (ORNSTEIN-UHLENBECK for $Z^{(1)}$, standard Brownian motion for $Z^{(i)}, i \geq 2$). It follows that Z_t is a Gaussian vector of law $\mathcal{N}^{(n)}(\mu_{t,y}, \sigma_t)$. Therefore, for any $t > 0$ and all $y \in \mathbb{R}^n$, \mathbb{P}_{Z_t} has a density with respect to the LEBESGUE measure on \mathbb{R}^n given by:

$$g_{t,y}^Z(z_1, \dots, z_n) = \frac{1}{(2\pi)^{\frac{n}{2}} \sqrt{\det(\sigma_t)}} \exp\left(-\frac{[z_1 - y_1 \exp(-2\gamma nt)]^2}{2e_4(t)} - \frac{1}{2t} \sum_{j=2}^n (z_j - y_j)^2\right). \quad (46)$$

Since, $X_t = PZ_t$, we deduce that for all $x \in \mathbb{R}^n$ and for all $t > 0$, X_t follows the normal distribution $\mathcal{N}^{(n)}(m_{t,x}, \Sigma_t)$, with density

$$g_{t,x}^X(r) := g_{t,P^{-1}x}^Z(P^{-1}r) = \frac{1}{(2\pi)^{\frac{n}{2}} \sqrt{\det(\Sigma_t)}} \exp\left(-\frac{(r - m_{t,x})^t \Sigma_t^{-1} (r - m_{t,x})}{2}\right). \quad (47)$$

Hence, $\mathbb{E}_x f(X_t)$ coincides with (41).

Step 2. $T^{(n)}(t)f$ is solution to (42) on $(0, +\infty) \times \mathbb{R}^n$. Without difficulty we verify that for any $y \in \mathbb{R}^n$, $g_{t,y}^Z$ satisfies the following FOKKER-PLANCK PDE:

$$\forall t > 0, \forall z \in \mathbb{R}^n, \quad \partial_t g_{t,y}^Z(z) = \frac{1}{2} \Delta_y g_{t,y}^Z(z) - 2\gamma n \partial_{y_1} g_{t,y}^Z(z). \quad (48)$$

We deduce from (47) that

$$\forall y \in \mathbb{R}^n, \forall r \in \mathbb{R}^n, \quad \partial_t g_{t,y}^Z(P^{-1}r) = \partial_t g_{t,Py}^X(r),$$

and, for all $y, r \in \mathbb{R}^n$, $\partial_{y_i} g_{t,y}^Z(P^{-1}r) = \sum_{k=1}^n P_{ki} \partial_{x_k} g_{t,Py}^X(r)$. In particular,

$$\partial_{y_1} g_{t,y}^Z(P^{-1}r) = \frac{1}{\sqrt{n}} \left(\nabla_x g_{t,Py}^X(r) \cdot \mathbf{1} \right).$$

In an analogous way, we deduce that

$$\Delta_y g_{t,y}^Z(P^{-1}r) = \sum_{i=1}^n \sum_{k,\ell=1}^n P_{ki} P_{\ell i} \partial_{x_\ell, x_k}^2 g_{t,Py}^X(r) = \Delta_x g_{t,Py}^X(r),$$

because P is an orthonormal matrix. From (48) and since $(P^{-1}x)_1 = \frac{(x \cdot \mathbf{1})}{\sqrt{n}}$, we deduce that the density $g_{t,x}^X$ satisfies:

$$\forall t > 0, \forall x \in \mathbb{R}^n, \forall r \in \mathbb{R}^n, \quad \partial_t g_{t,x}^X(r) - \frac{1}{2} \Delta_x g_{t,x}^X(r) + 2\gamma(x \cdot \mathbf{1}) \nabla_x g_{t,x}^X(r) = 0.$$

Now, the fact that for all $f \in L^\infty(\mathbb{R}^n, \mathbb{R})$,

$$T^{(n)}(t)f(x) = \int_{\mathbb{R}^n} f(r) g_{t,x}^X(r) dr$$

is $\mathcal{C}_b^{1,2}((0, +\infty) \times \mathbb{R}^n, \mathbb{R})$ and is a solution of (42) on $(0, +\infty) \times \mathbb{R}^n$ follows from the theorem of differentiation under the integral sign. Note that, if f is continuous,

$$T^{(n)}(t)f(x) = \mathbb{E}_x f(X_t) \xrightarrow[t \rightarrow 0]{} f(x)$$

by the dominated convergence theorem which leads to (43).

Step 3. Verification of (42) up to $t = 0$. Assume that $f \in \mathcal{C}_b^2(\mathbb{R}^n, \mathbb{R})$. This is equivalent to prove that for all $x \in \mathbb{R}^n$,

$$\lim_{t \rightarrow 0} \frac{\int_{\mathbb{R}^n} f(u) g_{t,x}^X(u) du - f(x)}{t} = \frac{1}{2} \Delta f(x) - 2\gamma(\nabla f(x) \cdot \mathbf{1})(x \cdot \mathbf{1}).$$

Let be $x \in \mathbb{R}^n$ fixed. Using TAYLOR's formula we obtain that

$$\int_{\mathbb{R}^n} f(u) g_{t,x}^X(u) du - f(x) = (\mathbf{A})_t + (\mathbf{B})_t + (\mathbf{C})_t,$$

where

$$\begin{aligned} (\mathbf{A})_t &:= \int_{\mathbb{R}^n} ([u - x] \cdot \nabla f(x)) g_{t,x}^X(u) du, & (\mathbf{B})_t &:= \frac{1}{2} \int_{\mathbb{R}^n} (u - x)^t \text{Hess} f(x) (u - x) g_{t,x}^X(u) du, \\ (\mathbf{C})_t &:= \int_{\mathbb{R}^n} R_x(u) g_{t,x}^X(u) du, \end{aligned}$$

where $R_x(u) := o(\|x - u\|_2^2)$. As $g_{t,x}^X$ is a Gaussian density of $\mathcal{N}^{(n)}(m_{t,x}, \Sigma_t)$, where

$$\begin{aligned} x - m_{t,x} &= (1 - \exp(-2\gamma nt)) \frac{(x \cdot \mathbf{1})}{\sqrt{n}} \times \frac{\mathbf{1}}{\sqrt{n}} \underset{t \rightarrow 0}{\sim} -2\gamma(x \cdot \mathbf{1})t, \\ \forall i \in \{1, \dots, n\}, & (\Sigma_t)_{ii} \underset{t \rightarrow 0}{\sim} t, \end{aligned} \tag{49}$$

it follows that

$$\begin{aligned} (\mathbf{A})_t &= (\nabla f(x) \cdot [m_{t,x} - x]) = -\frac{(1 - \exp(-2\gamma nt))}{n} (\nabla f(x) \cdot \mathbf{1})(x \cdot \mathbf{1}). \\ (\mathbf{B})_t &= \frac{1}{2} \int_{\mathbb{R}^n} (u - m_{t,x})^t \text{Hess} f(x) (u - m_{t,x}) g_{t,x}^X(u) du \\ &\quad + \frac{1}{2} (x - m_{t,x})^t \text{Hess} f(x) (x - m_{t,x}) \\ &= \frac{1}{2} \sum_{i,j=1}^n \partial_{x_i x_j} f(x) (\Sigma_t)_{ij} + (1 - \exp(-2\gamma nt))^2 \frac{(x \cdot \mathbf{1})^2}{2n^2} \mathbf{1}^t \text{Hess} f(x) \mathbf{1}. \end{aligned}$$

Therefore,

$$\lim_{t \rightarrow 0} \frac{(\mathbf{A})_t + (\mathbf{B})_t}{t} = -2\gamma (\nabla f(x) \cdot \mathbf{1})(x \cdot \mathbf{1}) + \frac{1}{2} \Delta f(x).$$

Now, it remains to manage the $(\mathbf{C})_t$ error term. Note that,

$$\begin{aligned} \forall \varepsilon > 0, \exists \alpha > 0, \forall u \in B(x, \alpha), \quad |R_x(u)| &\leq \varepsilon \|u - x\|_2^2. \\ \forall u \in \mathbb{R}^n \setminus B(x, \alpha), \quad |R_x(u)| &\leq 2 \|f\|_\infty + \|\nabla f\|_\infty \|u - x\|_2 \\ &\quad + \frac{1}{2} \|\text{Hess}f(x)\|_\infty \|u - x\|_2. \end{aligned}$$

Let $\varepsilon > 0$, $\alpha > 0$ and $t_0 \geq 0$ such that for all $t \in [0, t_0]$, $\|x - m_{t,x}\|_2 \leq \frac{\alpha}{2}$. Let $t \in [0, t_0]$. Separating the domain of integration of the integral of $(\mathbf{C})_t$ into $B(x, \alpha)$ and $\mathbb{R}^n \setminus B(x, \alpha)$, it follows from the YOUNG and previous inequalities that there exists a constant $C > 0$ such that

$$\begin{aligned} (\mathbf{C})_t &\leq \varepsilon \int_{\mathbb{R}^n} \|u - x\|_2^2 g_{t,x}^X(u) du + C \int_{\mathbb{R}^n \setminus B(x, \alpha)} (1 + \|u - x\|_2^2) g_{t,x}^X(u) du \\ &\leq 2\varepsilon \sum_{i=1}^n (\Sigma_t)_{ii} + 2(\varepsilon + C) \|x - m_{t,x}\|_2^2 + 2C \int_{\mathbb{R}^n \setminus B(x, \alpha)} (1 + \|u - m_{t,x}\|_2^2) g_{t,x}^X(u) du \end{aligned}$$

Now, for the choice of α and then the MARKOV inequality, we obtain that

$$\begin{aligned} \int_{\mathbb{R}^n \setminus B(x, \alpha)} (1 + \|u - m_{t,x}\|_2^2) g_{t,x}^X(u) du &\leq \left(1 + \frac{4}{\alpha^2}\right) \int_{\mathbb{R}^n \setminus B(m_{t,x}, \frac{\alpha}{2})} \|u - m_{t,x}\|_2^2 g_{t,x}^X(u) du \\ &\leq \left(1 + \frac{4}{\alpha^2}\right) \frac{\int_{\mathbb{R}^n} \|u - m_{t,x}\|_2^4 g_{t,x}^X(u) du}{\left(\frac{\alpha}{2}\right)^4} \\ &\leq \frac{16n}{\alpha^4} \left(1 + \frac{4}{\alpha^2}\right) \sum_{i=1}^n \int_{\mathbb{R}^n} (u_i - (m_{t,x})_i)^4 g_{t,x}^X(u) du. \end{aligned}$$

As for all $i \in \{1, \dots, n\}$, the fourth moment of a random variable of law $\mathcal{N}(0, (\Sigma_t)_{ii})$ is smaller than $3(\Sigma_t)_{ii}^2$, it follows from (49) that there exists a constant $\tilde{C} > 0$ such that

$$\frac{(\mathbf{C})_t}{t} \leq 2\varepsilon n + \varepsilon \tilde{C}$$

for t small enough and then the conclusion.

Step 4. Expression of the derivatives of $T^{(n)}(t)f$. Noting that for all $u \in \mathbb{R}^n$, $g_{t,x}^X(u) = g_{t,0}^X(u - m_{t,x})$ and using the symmetry property of this density, we obtain that

$$T^{(n)}(t)f(x) = (f * g_{t,0}^X)(m_{t,x}).$$

By the chain rule formula, we deduce the properties **(2)** and for all $i, j \in \{1, \dots, n\}$,

$$\begin{aligned} \partial_{x_i x_j}^2 T^{(n)}(t)f(x) &= (\partial_{x_j} m_{t,x})^t \left[(f * \text{Hess}(g_{t,0}^X))(m_{t,x}) \partial_{x_i} m_{t,x} \right] \\ &\quad + \left(\partial_{x_i x_j}^2 m_{t,x} \cdot (f * \nabla g_{t,0}^X)(m_{t,x}) \right). \end{aligned}$$

Now,

$$\partial_{x_i} m_{t,x} = \partial_{x_i} P\mu_{t,P^{-1}x} = \epsilon_i - (1 - \exp(-2\gamma nt)) (P^{-1})_{1i} P\epsilon_1.$$

The property **(3)** follows. \square

The following corollary is useful for bounding the dual process in the next subsection.

Corollary 6.2. *Let $f \in \mathcal{C}^2(\mathbb{R}^n, \mathbb{R})$. We assume that there exists a constant $C_1 > 0$ such that for all $x \in \mathbb{R}^n$,*

$$|f(x)| \leq C_1 (1 + \|x\|_2^{2n}).$$

Then, for all $t > 0$ and $x \in \mathbb{R}^n$, there exists two constants $C_2(t, n) > 0$ locally bounded on $\mathbb{R}_+ \times \mathbb{N}$ and $C_3(t, n) > 0$ locally bounded on $(0, +\infty) \times \mathbb{N}$ such that

$$\begin{aligned} \text{(1)} \quad & \left| T^{(n)}(t)f(x) \right| \leq C_2(t, n) (1 + \|x\|_2^{2n}) \\ \text{(2)} \quad & \left\| (\text{Hess}(g_{t,0}^X) * f)(m_{t,x}) \right\| \leq C_3(t, n) (1 + \|x\|_2^{2n}) \end{aligned}$$

Proof. Step 1. Proof of (1). From (46) and (47), note that for all $x, r \in \mathbb{R}^n$, $t \geq 0$, $g_{t,x}^X(r) = \prod_{j=1}^n g_{t,[P^{-1}x]_j}^{Z_j}([P^{-1}r]_j)$, where

$$\begin{aligned} g_{t,y_1}^{Z^{(1)}}(z_1) &:= \frac{1}{\sqrt{2\pi e_4(t)}} \exp\left(-\frac{[z_1 - y_1 \exp(-2\gamma nt)]^2}{2e_4(t)}\right) \\ g_{t,y_j}^{Z^{(j)}}(z_j) &:= \frac{1}{\sqrt{2\pi t}} \exp\left(-\frac{[z_j - y_j]^2}{2t}\right), \quad j \in \{2, \dots, n\}. \end{aligned} \tag{50}$$

Since $\|Pz\|_2 = \|z\|_2$ for all $z \in \mathbb{R}^n$, we also have

$$\int_{\mathbb{R}^n} \|u\|_2^{2n} g_{t,x}^X(u) du = \int_{\mathbb{R}^n} \|z\|_2^{2n} g_{t,P^{-1}x}^Z(z) dz.$$

Hence,

$$\int_{\mathbb{R}^n} \|u\|_2^{2n} g_{t,x}^X(u) du \leq n^{n-1} \sum_{i=1}^n \int_{\mathbb{R}^n} z_i^{2n} \prod_{j=1}^n g_{t,[P^{-1}x]_j}^{Z^{(j)}}(z_j) dz = n^{n-1} \sum_{i=1}^n \mathbb{E} \left([Z^{(i)}]^{2n} \right).$$

Classical moment bounds for Gaussian random variables show that $\mathbb{E}(G^{2n}) \leq C(n)t^{2n}$ for $G \sim \mathcal{N}(0, t)$ and $C(n) > 0$. Since $e_4(t) \leq t$ and using (50), we deduce that there exists two constants $\tilde{C}_1(n)$ and $\tilde{C}_2(t, n)$ such that for all $i \in \{1, \dots, n\}$

$$\mathbb{E} \left([Z^{(i)}]^{2n} \right) \leq \tilde{C}_1(n) \left((P^{-1}x)_i^{2n} + t^{2n} \right) \leq \tilde{C}_2(t, n) \left(1 + \|P^{-1}x\|_2^{2n} \right).$$

The result **(1)** follows.

Step 2. Proof of (2). Now, we want to control, for all $i, j \in \{1, \dots, n\}$,

$$\left| \left(\text{Hess} \left(g_{t,0}^X \right) * f \right) (m_{t,x}) \right|_{ij} \leq C_1(n) \int_{\mathbb{R}^n} \left| \partial_{r_i r_j}^2 g_{t,0}^X(r) \right| \left(1 + \|m_{t,x} - r\|_2^{2n} \right) dr.$$

For all $k \in \{1, \dots, n\}$, we consider:

$$V_k(t) := \begin{cases} e_4(t) & \text{if } k = 1 \\ t & \text{if } k \neq 1 \end{cases}.$$

From (50), we deduce that for all $i, j, k \in \{1, \dots, n\}$, for all $t > 0$,

$$\begin{aligned} \partial_{r_i} g_{t,0}^{Z^{(k)}} \left((P^{-1}r)_k \right) &= - \frac{(P^{-1})_{ki} (P^{-1}r)_k}{V_k(t)} g_{t,0}^{Z^{(k)}} \left((P^{-1}r)_k \right), \\ \partial_{r_j r_i}^2 g_{t,0}^{Z^{(k)}} \left((P^{-1}r)_k \right) &= \frac{(P^{-1})_{kj} (P^{-1})_{ki}}{V_k(t)} \left(\frac{(P^{-1}r)_k^2}{V_k(t)} - 1 \right) g_{t,0}^{Z^{(k)}} \left((P^{-1}r)_k \right). \end{aligned}$$

Hence, for all $i, j \in \{1, \dots, n\}$, for all $t > 0$,

$$\begin{aligned} \partial_{r_j r_i}^2 g_{t,0}^X(r) &= \sum_{k=1}^n \frac{(P^{-1})_{kj} (P^{-1})_{ki}}{V_k(t)} \left(\frac{(P^{-1}r)_k^2}{V_k(t)} - 1 \right) g_{t,0}^X(r) \\ &\quad + \sum_{k=1}^n \sum_{\substack{\ell=1 \\ \ell \neq k}}^n \frac{(P^{-1})_{kj} (P^{-1})_{\ell j}}{V_k(t) V_\ell(t)} (P^{-1}r)_k (P^{-1}r)_\ell g_{t,0}^X(r) \end{aligned}$$

Noting that for all $i, j, k \in \{1, \dots, n\}$, $|(P^{-1})_{ij}| \leq 1$ and $|(P^{-1}r)_k| \leq n \|r\|_2$,

$$\|m_{t,x} - r\|_2^{2n} \leq 2^{2n-1} \left(\|r\|_2^{2n} + 2^{2n-1} n^n (2 - \exp(-2\gamma nt)) \|x\|_2^{2n} \right),$$

we deduce that for all $i, j \in \{1, \dots, n\}$, there exists a constant $\tilde{C}_3(t, n) > 0$ locally bounded on $(0, +\infty) \times \mathbb{N}$ such that

$$\begin{aligned} &\int_{\mathbb{R}^n} \left| \partial_{r_i r_j}^2 g_{t,0}^X(r) \right| \|m_{t,x} - r\|_2^{2n} dr \\ &\leq \int_{\mathbb{R}^n} \left[\frac{1}{e_4(t)} \left(\frac{n^2 \|r\|_2^2}{e_4(t)} + 1 \right) + \frac{n-1}{t} \left(\frac{n^2 \|r\|_2^2}{t} + 1 \right) + n^3 \left(\frac{1}{e_4(t)} + \frac{n-1}{t} \right) \|r\|_2^2 \right] \\ &\quad \times g_{t,0}^X(r) \|m_{t,x} - r\|_2^{2n} dr \\ &\leq \tilde{C}_3(t, n) \left(1 + \|x\|_2^{2n} \right). \end{aligned}$$

The announced result (2) follows. \square

6.1.2 MILD formulation

In this subsection, we establish the MILD formulation associated with the martingale problem (15).

Proposition 6.3. *Let $(X_t)_{t \geq 0}$ be a stochastic process whose the law \mathbb{P}_μ is solution to the martingale problem (2) with initial value μ . Then, for all $f \in \mathcal{C}_b^2(\mathbb{R}^n, \mathbb{R})$,*

$$\begin{aligned} & \langle T^{(n)}(t_0 - t)f, X_t^n \rangle - \gamma \int_0^t \sum_{i=1}^n \sum_{\substack{j=1 \\ j \neq i}}^n \left[\langle \Phi_{i,j} T^{(n)}(t_0 - s)f, X_s^{n-1} \rangle - \langle T^{(n)}(t_0 - s)f, X_s^n \rangle \right] ds \\ & - \gamma \int_0^t \sum_{i=1}^n \sum_{j=1}^n \langle K_{i,j} T^{(n)}(t_0 - s)f, X_s^{n+1} \rangle ds \end{aligned}$$

is a \mathbb{P}_μ -martingale for $0 \leq t \leq t_0$.

Proof. Let $t_0 \geq 0$. Let $u, v, w : [0, t_0] \times \mathcal{M}_1^{c,2}(\mathbb{R}) \times \tilde{\Omega} \rightarrow \mathbb{R}$ be $\mathcal{B}([0, t_0]) \otimes \mathcal{B}(\mathcal{M}_1^{c,2}(\mathbb{R})) \otimes \tilde{\mathcal{F}}$ -measurable defined by

$$\begin{aligned} \bullet u(r, \mu) &:= \langle T^{(n)}(t_0 - r)f, \mu^n \rangle, & \bullet v(r, \mu) &:= - \langle \partial_t T^{(n)}(t_0 - r)f, \mu^n \rangle, \\ \bullet w(r, \mu) &:= \mathcal{L}_{FVc} \langle T^{(n)}(t_0 - r)f, \mu^n \rangle. \end{aligned}$$

The expected result is a direct consequence of a version of Lemma 4.3.4 of [25] where we replace the assumption of boundedness on w by an assumption of domination. Hence, we need to check the following assumptions of this lemma:

(i) The process $(u(t, X_t))_{t \geq 0}$ is $(\tilde{\mathcal{F}}_t)_{t \geq 0}$ -adapted and the processes $(v(t, X_t))_{t \geq 0}$ and $(w(t, X_t))_{t \geq 0}$ are $(\tilde{\mathcal{F}}_t)_{t \geq 0}$ -progressive. These properties are standard in our case.

(ii) The functions u, v are bounded on $[0, t_0] \times \mathcal{M}_1^{c,2}(\mathbb{R})$ and there exists $C > 0$ such that for all $t \in [0, t_0]$, for all $\mu \in \mathcal{M}_1^{c,2}(\mathbb{R})$, $w(t, \mu) \leq C(1 + M_2(\mu))$ where we recall that $M_2(\mu) = \langle \text{id}^2, \mu \rangle$.

(iii) The function $\mu \mapsto v(t, \mu, \tilde{\omega})$ is continuous for fixed t and $\tilde{\omega}$.

(iv) For all $t_0 \geq t_2 > t_1 \geq 0$,

$$\mathbb{E} \left(u(t_2, X_{t_2}) - u(t_1, X_{t_2}) \middle| \tilde{\mathcal{F}}_{t_1} \right) = \mathbb{E} \left(\int_{t_1}^{t_2} v(s, X_{t_2}) ds \middle| \tilde{\mathcal{F}}_{t_1} \right), \quad (51)$$

and

$$\mathbb{E} \left(u(t_1, X_{t_2}) - u(t_1, X_{t_1}) \middle| \tilde{\mathcal{F}}_{t_1} \right) = \mathbb{E} \left(\int_{t_1}^{t_2} w(t_1, X_s) ds \middle| \tilde{\mathcal{F}}_{t_1} \right). \quad (52)$$

(v) The process $(X_t)_{t \geq 0}$ is right continuous (here, it is continuous) and

$$\lim_{\delta \rightarrow 0_+} \mathbb{E} (|w(t - \delta, X_t) - w(t, X_t)|) = 0, \quad t_0 > t > 0. \quad (53)$$

Step 1. Verification of assumptions (ii) and (iii). From Theorem 6.1, for all $f \in \mathcal{C}_b^2(\mathbb{R}^n, \mathbb{R})$, $(t, x) \mapsto T^{(n)}(t)f(x)$ is bounded on $[0, t_0] \times \mathbb{R}^n$. The boundedness of u follows.

Moreover, as $(t, x) \mapsto T^{(n)}(t)f(x)$ is solution of the PDE (42), we obtain for all $r \in [0, t_0]$ and $\mu \in \mathcal{M}_1^{c;2}(\mathbb{R})$ that

$$v(r, \mu) = -\frac{1}{2} \langle \Delta T^{(n)}(t_0 - r)f, \mu^n \rangle + 2\gamma \langle (\nabla T^{(n)}(t_0 - r)f \cdot \mathbf{1}) (\text{id} \cdot \mathbf{1}), \mu^n \rangle.$$

Since $\mu \in \mathcal{M}_1^{c;2}(\mathbb{R})$, the second term of the right hand side is well-defined. Using the properties **(2)** and **(3)** of Theorem 6.1, we deduce that v is bounded on $[0, t_0] \times \mathcal{M}_1^{c;2}(\mathbb{R})$. In addition, $\Delta T^{(n)}(t_0 - r)f$ and $(\nabla T^{(n)}(t_0 - r)f \cdot \mathbf{1})$ are continuous bounded, hence $\mu \mapsto v(r, \mu)$ is continuous on $\mathcal{M}_1(\mathbb{R})$ for the topology of weak convergence. Now, using (14), (16), (17), (18) and Theorem 6.1 **(2)** and **(3)**, note that for all $r \in [0, t_0]$ and $\mu \in \mathcal{M}_1^{c;2}(\mathbb{R})$, there exists a constant $C_f > 0$ such that,

$$\begin{aligned} w(r, \mu) &= \langle \partial_t T^{(n)}(t_0 - r)f, \mu^n \rangle + \gamma \sum_{i,j=1}^n \langle K_{ij} T^{(n)}(t_0 - r)f, \mu^{n+1} \rangle \\ &\quad + \gamma \sum_{\substack{i,j=1 \\ j \neq i}}^n \left[\langle \Phi_{ij} T^{(n)}(t_0 - r)f, \mu^{n-1} \rangle - \langle T^{(n)}(t_0 - r)f, \mu^n \rangle \right] \\ &\leq C_f (1 + M_2(\mu)), \end{aligned} \tag{54}$$

where the bound $M_2(\mu)$ comes from K_{ij} .

Step 2. Verification of assumption (iv) and (v). Let $t_2 > t_1 \geq 0$. On the one hand,

$$u(t_2, X_{t_2}) - u(t_1, X_{t_2}) = \left\langle - \int_{t_1}^{t_2} \partial_t T^{(n)}(t_0 - s)f ds, X_{t_2}^n \right\rangle = \int_{t_1}^{t_2} v(s, X_{t_2}) ds$$

and the relation (51) follows. On the other hand, as the martingale problem (2) classically involves the martingale problem (15) [22], we obtain that

$$\begin{aligned} u(t_1, X_{t_2}) - u(t_1, X_{t_1}) &= \langle T^{(n)}(t_0 - t_1)f, X_{t_2}^n - X_{t_1}^n \rangle \\ &= \int_{t_1}^{t_2} \mathcal{L}_{FVc} \langle T^{(n)}(t_0 - t_1)f, X_s^n \rangle ds \\ &\quad + \widehat{M}_{t_2}^{(n)}(T^{(n)}(t_0 - t_1)f) - \widehat{M}_{t_1}^{(n)}(T^{(n)}(t_0 - t_1)f). \end{aligned}$$

The relation (52) follows. Finally, from (54), Proposition 2.11 and the LEBESGUE dominated convergence theorem, we deduce the relation (53). \square

6.2 Proof of Lemma 3.5

Recall that, our goal is to prove that the stopping time θ_k , defined by

$$\forall k \in \mathbb{N}, \quad \theta_k := \inf \left\{ t \geq 0 \mid M(t) \geq k \text{ or } \exists s \in [0, t], \langle \xi_s, X_{t-s}^{M(s)} \rangle \geq k \right\},$$

satisfies $\lim_{k \rightarrow +\infty} \theta_k = +\infty$, $\mathbb{P}_{(\mu, \xi_0)}$ -a.s. with $\mu \in \mathcal{M}_1^{c;2}(\mathbb{R})$ and $\xi_0 \in \mathcal{C}_b^2(\mathbb{R}^{M(0)}, \mathbb{R})$. Before to prove Lemma 3.5, we introduce the following lemma, whose proof will be given at Subsubsection 6.2.2. We denote by S_t the number of jumps of the process M on the time interval $[0, t]$.

Lemma 6.4. *If $\xi_0 \in \mathcal{C}_b^2(\mathbb{R}^n, \mathbb{R})$ then there exists a finite function $C(t, n)$ on $\mathbb{R}_+ \times \mathbb{N}$ locally bounded non-decreasing in both variables such that for all $T > 0$,*

$$\forall t \in [0, T], \forall x \in \mathbb{R}^{M(t)}, \quad |\xi_t(x)| \leq C(T, S_T) \left(1 + \|x\|_2^{2S_T}\right).$$

The bound obtained above will only allow us to show that $\theta_k \rightarrow +\infty$ $\mathbb{P}_{(\mu, \xi_0)}$ -a.s. under the assumption that the initial condition X_0 has all its finite moments. The following remark shows that we cannot expect that $\theta_k \rightarrow +\infty$ under weaker assumptions on the initial condition.

Remark 6.5. *Let $\xi_0 : x \mapsto \sin(x) \in \mathcal{C}_b^2(\mathbb{R}, \mathbb{R})$. Let us assume that $\langle |\text{id}|^4, \mu \rangle = +\infty$ and ξ_t successively jumps at times τ_1, τ_2 and τ_3 with respective jump operator K_{11}, K_{11} and Φ_{13} . If we denote by $\tau_{1,2} := \tau_2 - \tau_1$, straightforward but tedious computations give*

$$\xi_{\tau_1}(x, y) = K_{11}T^{(1)}(\tau_1)\xi_0(x, y) = -\exp\left(-\frac{e_4(\tau_1)}{2} - 4\gamma\tau_1\right) \sin(x \exp(-2\gamma\tau_1)) y^2$$

and

$$\begin{aligned} \xi_{\tau_2}(x, y, z) &= K_{11}T^{(2)}(\tau_{1,2})\xi_{\tau_1}(x, y, z) \\ &= \frac{1}{4} \exp\left(-\frac{e_4(\tau_1)}{2} - 4\gamma\tau_1 - \exp(-4\gamma\tau_1) - \frac{\exp(-4\gamma\tau_1)(e_4(\tau_{1,2}) - \tau_{1,2})^2}{4(e_4(\tau_{1,2}) + \tau_{1,2})}\right) \\ &\times \left[\left\{ \frac{\exp(-4\gamma\tau_1)}{4} (1 + \exp(-4\gamma\tau_{1,2}))^2 \left[2(e_4(\tau_{1,2}) + \tau_{1,2}) - \exp(-4\gamma\tau_1)(e_4(\tau_{1,2}) - \tau_{1,2})^2 \right. \right. \right. \\ &+ \left. \left. \left. (x[1 - \exp(-4\gamma\tau_{1,2})] - y[1 + \exp(-4\gamma\tau_{1,2})])^2 \right] - 2(1 + \exp(-8\gamma\tau_1) - \exp(-4\gamma\tau_1)) \right. \right. \\ &- \left. \left. 2\exp(-4\gamma\tau_1)(1 - \exp(-8\gamma\tau_{1,2}))(e_4(\tau_{1,2}) - \tau_{1,2}) \right\} \right. \\ &\times \left. \sin\left(\frac{\exp(-2\gamma\tau_1)}{2} [x - y + (x + y)\exp(-4\gamma\tau_{1,2})]\right) \right. \\ &- \left. 2\exp(-2\gamma\tau_1)(1 + \exp(-4\gamma\tau_{1,2})) \left\{ x - y + (x + y)\exp(-8\gamma\tau_{1,2}) - x\exp(-4\gamma\tau_{1,2}) \right. \right. \\ &- \left. \left. \frac{\exp(-4\gamma\tau_{1,2})}{2} (e_4(\tau_{1,2}) - \tau_{1,2}) [-(x - y) + (x + y)\exp(-4\gamma\tau_{1,2})] \right\} \right. \\ &\times \left. \left. \cos\left(\frac{\exp(-2\gamma\tau_1)}{2} [x - y + (x + y)\exp(-4\gamma\tau_{1,2})]\right) \right] z^2. \end{aligned}$$

Note that the leading order term in $\xi_{\tau_2}(x, y, z)$ is of the form $(ax - by)^2 z^2 \sin(cx + dy)$. Now,

$$\xi_{\tau_3}(x, y) = \Phi_{13}T^{(3)}(\tau_3 - \tau_2)\xi_{\tau_2}(x, y).$$

If $\tau_3 = \tau_2$, we obtain as leading order term in $\xi_{\tau_3}(x, y)$ the term $(ax - by)^2 x^2 \sin(cx + dy)$, which is not integrable with respect to $\mu^2(dx, dy)$. If $\tau_3 > \tau_2$, one can check that the leading order term in $T^{(3)}(\tau_3 - \tau_2)\xi_{\tau_2}(x, y, z)$ is of the form $P_4(x, y, z) \sin(\tilde{c}x + \tilde{d}y + \tilde{e}z)$ where $P_4(X, Y, Z)$ is a homogeneous polynomial of degree 4 such that $P_4(X, Y, Z) \rightarrow (aX - bY)^2 Z^2$, $\tilde{c} \rightarrow c$,

$\tilde{d} \rightarrow d$ and $\tilde{e} \rightarrow 0$ when $\tau_3 \rightarrow \tau_2$. Therefore, for τ_3 close enough to τ_2 , $\xi_{\tau_3}(x, y)$ has a non-zero term proportional to $x^4 \sin([\tilde{c} + \tilde{e}]x + \tilde{d}y)$ which is not compensated by another term. Hence, $\langle |\xi_{\tau_3}|, \mu^2 \rangle = +\infty$ if $\tau_3 - \tau_2$ is small enough, for any values of τ_1 and τ_2 . Given T large enough, we have proved that $\theta_k \leq \tau_3 \leq T$ with positive probability.

6.2.1 Proof that Lemma 6.4 implies Lemma 3.5

Note that $\theta_k = \hat{\theta}_k \wedge \tilde{\theta}_k$ where

$$\hat{\theta}_k := \inf \left\{ t \geq 0 \mid M(t) \geq k \right\} \quad \text{and} \quad \tilde{\theta}_k := \inf \left\{ t \geq 0 \mid \exists s \in [0, t], \langle \xi_s, X_{t-s}^{M(s)} \rangle \geq k \right\}.$$

Thanks to (27) it follows that $\hat{\theta}_k \rightarrow +\infty$ when $k \rightarrow +\infty$. In order to prove that $\tilde{\theta}_k \rightarrow +\infty$ when $k \rightarrow +\infty$, we rely on the control of the dual process obtained in Lemma 6.4. So we need to control $\langle \|\cdot\|_2^{2S_T}, X_{t-s}^{M(s)} \rangle$. Let $T > 0$ and $\varepsilon > 0$ be arbitrary. From (27), we choose $A(T, \varepsilon) > 0$ such that $\mathbb{P}_{(\mu, \xi_0)}(S_T \leq A) \geq 1 - \frac{\varepsilon}{2}$. Then, using Proposition 2.11, we choose $B(T, \varepsilon, A) > 0$ such that $\mathbb{P}_{(\mu, \xi_0)}(\forall k \leq 2A, \forall t \leq T, \langle |\text{id}|^k, X_t \rangle \leq B) \geq 1 - \frac{\varepsilon}{2}$. We recall that for any $m \in \mathbb{N}^*$, for all $x \in \mathbb{R}^m$, $(\sum_{i=1}^m x_i)^n \leq m^{n-1} \sum_{i=1}^m x_i^n$. Thus, the following inequality

$$\begin{aligned} \langle \|\cdot\|_2^{2S_T}, X_{t-s}^{M(s)} \rangle &\leq M(s)^{S_T-1} \sum_{i=1}^{M(s)} \int_{\mathbb{R}^{M(s)}} x_i^{2S_T} X_{t-s}^{M(s)}(dx) = M(s)^{S_T} \langle \text{id}^{2S_T}, X_{t-s} \rangle \\ &\leq (M(0) + A)^A B, \end{aligned}$$

takes place with probability $1 - \varepsilon$. Therefore, we deduce from Lemma 6.4 that for all $s \leq t \leq T$,

$$\langle \xi_s, X_{t-s}^{M(s)} \rangle \leq C(T, A) (M(0) + A)^A B$$

In particular, for $k \geq C(T, A) (1 + (M(0) + A)^A B)$, it follows that

$$\mathbb{P}_{(\mu, \xi_0)}(\tilde{\theta}_k \geq T) \geq \mathbb{P}_{(\mu, \xi_0)}(\{S_T \leq A\} \cap \{\forall k \leq 2A, \forall t \leq T, \langle \text{id}^k, X_t \rangle \leq B\}) \geq 1 - \varepsilon.$$

The conclusion follows. \square

6.2.2 Proof of Lemma 6.4

By mathematical induction on $k \in \mathbb{N}$, we prove the property

$$(\mathcal{P}_k) : \quad \forall t \in [\tau_k, \tau_{k+1}[, \forall x \in \mathbb{R}^{M(t)}, \quad |\xi_t(x)| \leq C_0((\tau_{i+1} - \tau_i)_{0 \leq i \leq k}, k) (1 + \|x\|_2^{2k}),$$

where C_0 is locally bounded on $\bigcup_{k \in \mathbb{N}} (0, +\infty)^k \times \{k\}$.

Initial case. For $k = 0$, $S_0 = 0$ and $\xi_0 \in \mathcal{C}_b^2(\mathbb{R}^n, \mathbb{R})$. Hence, the property (\mathcal{P}_0) is satisfied.

Inductive step. We assume that, for $k \in \mathbb{N}^*$, the property (\mathcal{P}_{k-1}) is satisfied and prove that (\mathcal{P}_k) is also. Let $t \in [\tau_k, \tau_{k+1}[$ and note that $M(t) = M(\tau_k)$. We make a partition of cases

according to whether the dual process loses or gains.

Step 1. Case $\Gamma_k = \Phi_{i,j}$ at the k^{th} jump. In this case, $M(\tau_k) = M(\tau_{k-1}) - 1$ and we deduce from the explicit expression (24) of the dual process that

$$\xi_t(x) = T^{(M(\tau_{k-1})-1)}(t - \tau_k) \Phi_{i,j} T^{(M(\tau_{k-1}))}(\tau_k - \tau_{k-1}) \xi_{\tau_{k-1}}(x).$$

By using expression (17) of $\Phi_{i,j}$ and the property (\mathcal{P}_{k-1}) , we deduce from Corollary 6.2 (1) that for all $x \in \mathbb{R}^{M(\tau_{k-1})-1}$,

$$\begin{aligned} & \left| \Phi_{i,j} T^{(M(\tau_{k-1}))}(\tau_k - \tau_{k-1}) \xi_{\tau_{k-1}}(x) \right| \\ & \leq C_2(\tau_k - \tau_{k-1}, M(\tau_{k-1})) C_0((\tau_{i+1} - \tau_i)_{1 \leq i \leq k-1}, k) \left(1 + \|x\|_2^{2(k-1)}\right), \end{aligned}$$

where $C_2 C_0$ is locally bounded. Using again Corollary 6.2 (1), we deduce the property (\mathcal{P}_k) .

Step 2. Case $\Gamma_k = K_{i,j}$ at the k^{th} jump. In this case, $M(\tau_k) = M(\tau_{k-1}) + 1$ and the explicit expression (24) of dual process that

$$\xi_t(x) = T^{(M(\tau_{k-1})+1)}(t - \tau_k) K_{i,j} T^{(M(\tau_{k-1}))}(\tau_k - \tau_{k-1}) \xi_{\tau_{k-1}}(x).$$

From the expression (18) of $K_{i,j}$ and Theorem 6.1 (3), we have for all $x \in \mathbb{R}^{M(\tau_{k-1})+1}$,

$$\begin{aligned} & \left| K_{i,j} T^{(M(\tau_{k-1})+1)}(\tau_k - \tau_{k-1}) \xi_{\tau_{k-1}}(x) \right| \\ & = \left| (\partial_{x_j} m_{\tau_k - \tau_{k-1}, \tilde{x}})^t \left[(\xi_{\tau_{k-1}} * \text{Hess}(g_{\tau_k - \tau_{k-1}, 0}^X)) (m_{\tau_k - \tau_{k-1}, \tilde{x}}) \partial_{x_i} m_{\tau_k - \tau_{k-1}, \tilde{x}} \right] \right| x_{M(\tau_{k-1})+1}^2, \end{aligned}$$

where $\tilde{x} = (x_1, \dots, x_{M(\tau_{k-1})})^t \in \mathbb{R}^{M(\tau_{k-1})}$. From the property (\mathcal{P}_{k-1}) and Corollary 6.2 (2), we deduce that

$$\begin{aligned} & \left| K_{i,j} T^{(M(\tau_{k-1})+1)}(\tau_k - \tau_{k-1}) \xi_{\tau_{k-1}}(x) \right| \\ & \leq C_3(\tau_k - \tau_{k-1}, M(\tau_{k-1})) C_0((\tau_{i+1} - \tau_i)_{1 \leq i \leq k-1}, k) \left(1 + \|x\|_2^{2k}\right), \end{aligned}$$

where $C_3 C_0$ is locally bounded. Using Corollary 6.2 (1), we deduce the property (\mathcal{P}_k) . We conclude by the principle of induction. \square

6.3 Proof of Theorem 3.4

Recall that $(X_t)_{t \geq 0}$ is a stochastic process whose law \mathbb{P}_μ is a solution of the martingale problem (2) with $\mu \in \mathcal{M}_1^{c,2}(\mathbb{R})$ and $(\xi_t)_{t \geq 0}$ a dual process independent of $(X_t)_{t \geq 0}$ built on the same probability space. To simplify, we will note $\mathbb{P} = \mathbb{P}_{(\mu, \xi_0)}$ the distribution of $((X_t, \xi_t))_{t \geq 0}$. As $\xi_0 \in \mathcal{C}_b^2(\mathbb{R}^{M(0)}, \mathbb{R})$ and for the choice of the stopping time θ_k given by (28), the set of quantities, involved in the expectations of the weakened duality identity (29), are bounded.

Step 1. Approximation reasoning. To establish the relation (29) we introduce a increasing sequence $0 = t_0^n < t_1^n < \dots < t_{p_n}^n = t$ of subdivisions of $[0, t]$ such that $t_{i+1}^n = t_i^n + h$ with h tending to 0. Note that

$$\begin{aligned} & \mathbb{E} \left(\left\langle \xi_{t \wedge \theta_k}, X_0^{M(t \wedge \theta_k)} \right\rangle \exp \left(\gamma \int_0^{t \wedge \theta_k} M^2(u) du \right) \right) - \mathbb{E} \left(\left\langle \xi_0, X_{t \wedge \theta_k}^{M(0)} \right\rangle \right) \\ &= \sum_{i=0}^{p_n-1} \left[\mathbb{E} \left(\left\langle \xi_{t_{i+1}^n \wedge \theta_k}, X_{t \wedge \theta_k - t_{i+1}^n \wedge \theta_k}^{M(t_{i+1}^n \wedge \theta_k)} \right\rangle \exp \left(\gamma \int_0^{t_{i+1}^n \wedge \theta_k} M^2(u) du \right) \right) \right. \\ & \quad \left. - \mathbb{E} \left(\left\langle \xi_{t_i^n \wedge \theta_k}, X_{t \wedge \theta_k - t_i^n \wedge \theta_k}^{M(t_i^n \wedge \theta_k)} \right\rangle \exp \left(\gamma \int_0^{t_i^n \wedge \theta_k} M^2(u) du \right) \right) \right]. \end{aligned}$$

We are therefore interested in terms of the form

$$\begin{aligned} & \mathbb{E} \left(\left\langle \xi_{(s+h) \wedge \theta_k}, X_{t \wedge \theta_k - (s+h) \wedge \theta_k}^{M((s+h) \wedge \theta_k)} \right\rangle \exp \left(\gamma \int_0^{(s+h) \wedge \theta_k} M^2(u) du \right) \right) \\ & - \mathbb{E} \left(\left\langle \xi_{s \wedge \theta_k}, X_{t \wedge \theta_k - s \wedge \theta_k}^{M(s \wedge \theta_k)} \right\rangle \exp \left(\gamma \int_0^{s \wedge \theta_k} M^2(u) du \right) \right), \quad \text{for } s \in [0, t-h]. \end{aligned} \tag{55}$$

It is sufficient to prove that these quantities are $O(h^2)$. The procedure to be adopted is as follows. First of all, we consider separately the two terms which constitute (55) in Steps 2 and 3. Then, we prove that the sum of these terms is $O(h^2)$ in Steps 4 and 5. Throughout this subsection, in order to simplify the writing, the following notations are introduced:

$$t_k := t \wedge \theta_k, \quad s_k := s \wedge \theta_k, \quad \text{and} \quad s_k^h := (s+h) \wedge \theta_k.$$

We note respectively τ_1, τ_2 the first and second jump times after s_k for the process M . We denote by $\tau_{1,k} := \tau_1 \wedge \theta_k$ and $\tau_{2,k} := \tau_2 \wedge \theta_k$.

Step 2. First term of (55). We exploit the explicit expression (24) of the dual process and make the following partition:

- (a) If there has been *no* jump of M on the interval $[s_k, s_k^h]$.
- (b) If there was *only one* jump of M on the interval $[s_k, s_k^h]$ and distinguish according to the events $\{\Gamma = \Phi_{i,j}\}$ and $\{\Gamma = K_{i,j}\}$ where Γ is the first Γ_k defined by (25) and (26) after s_k .
- (c) If there are *two or more than two* jumps of M on the interval $[s_k, s_k^h]$.

Then

$$\begin{aligned}
& \mathbb{E} \left(\left\langle \xi_{s_k^h}, X_{t_k - s_k^h}^{M(s_k^h)} \right\rangle \exp \left(\gamma \int_0^{s_k^h} M^2(u) du \right) \middle| \widetilde{\mathcal{F}}_{s_k} \right) \\
&= \mathbb{E} \left(\left\langle \xi_{s_k^h}, X_{t_k - s_k^h}^{M(s_k^h)} \right\rangle \exp \left(\gamma \int_0^{s_k^h} M^2(u) du \right) \mathbb{1}_{\{\tau_{1,k} > s_k^h\}} \middle| \widetilde{\mathcal{F}}_{s_k} \right) \\
&\quad + \sum_{\substack{i,j=1 \\ i \neq j}}^{M(s_k)} \mathbb{E} \left(\left\langle \xi_{s_k^h}, X_{t_k - s_k^h}^{M(s_k^h)} \right\rangle \exp \left(\gamma \int_0^{s_k^h} M^2(u) du \right) \mathbb{1}_{\{\tau_{1,k} \leq s_k^h, \tau_{2,k} > s_k^h, \Gamma = \Phi_{i,j}\}} \middle| \widetilde{\mathcal{F}}_{s_k} \right) \\
&\quad + \sum_{i,j=1}^{M(s_k)} \mathbb{E} \left(\left\langle \xi_{s_k^h}, X_{t_k - s_k^h}^{M(s_k^h)} \right\rangle \exp \left(\gamma \int_0^{s_k^h} M^2(u) du \right) \mathbb{1}_{\{\tau_{1,k} \leq s_k^h, \tau_{2,k} > s_k^h, \Gamma = K_{i,j}\}} \middle| \widetilde{\mathcal{F}}_{s_k} \right) \\
&\quad + \mathbb{E} \left(\left\langle \xi_{s_k^h}, X_{t_k - s_k^h}^{M(s_k^h)} \right\rangle \exp \left(\gamma \int_0^{s_k^h} M^2(u) du \right) \mathbb{1}_{\{\tau_{2,k} \leq s_k^h\}} \middle| \widetilde{\mathcal{F}}_{s_k} \right).
\end{aligned}$$

We consider successively each term in the right-hand side.

Firts term: no jump. As there is no jump on $[s_k, s_k^h]$, we have $M(s_k^h) = M(s_k)$ and $\xi_{s_k^h} = T^{(M(s_k))}(s_k^h - s_k) \xi_{s_k}$. Thus,

$$\begin{aligned}
& \mathbb{E} \left(\left\langle \xi_{s_k^h}, X_{t_k - s_k^h}^{M(s_k^h)} \right\rangle \exp \left(\gamma \int_0^{s_k^h} M^2(u) du \right) \mathbb{1}_{\{\tau_{1,k} > s_k^h\}} \middle| \widetilde{\mathcal{F}}_{s_k} \right) \\
&= \left\langle T^{(M(s_k))}(s_k^h - s_k) \xi_{s_k}, X_{t_k - s_k^h}^{M(s_k)} \right\rangle \exp \left(\gamma \int_0^{s_k} M^2(u) du - [\gamma (s_k^h - s_k) M(s_k) (M(s_k) - 1)] \right)
\end{aligned}$$

where we used the fact that $\tau_{1,k} - s_k$ given $\widetilde{\mathcal{F}}_{s_k}$ follows an exponential law of parameter $\gamma M^2(s_k) + \gamma M(s_k)(M(s_k) - 1)$.

Second and third terms : only one jump. These terms are treated in an analogous way, so we only give the details for the first one.

If there is a jump on $[s_k, s_k^h]$ and for $i \neq j \in \{1, 2, \dots, M(s_k)\}$ fixed, $\Gamma = \Phi_{i,j}$, then $M(s_k^h) = M(s_k) - 1$ and $\xi_{s_k^h} = T^{(M(s_k)-1)}(s_k^h - \tau_{1,k}) \Phi_{i,j} T^{(M(s_k))}(\tau_{1,k} - s_k) \xi_{s_k}$. Thus,

$$\begin{aligned}
& \mathbb{E} \left(\left\langle \xi_{s_k^h}, X_{t_k - s_k^h}^{M(s_k^h)} \right\rangle \exp \left(\gamma \int_0^{s_k^h} M^2(u) du \right) \mathbb{1}_{\{\tau_{1,k} \leq s_k^h, \tau_{2,k} > s_k^h, \Gamma = \Phi_{i,j}\}} \middle| \widetilde{\mathcal{F}}_{s_k} \right) \\
&= \left\langle T^{(M(s_k)-1)}(s_k^h - \tau_{1,k}) \Phi_{i,j} T^{(M(s_k))}(\tau_{1,k} - s_k) \xi_{s_k}, X_{t_k - s_k^h}^{M(s_k)-1} \right\rangle \\
&\quad \times \exp \left(\gamma \int_0^{s_k} M^2(u) du + \gamma [\tau_{1,k} - s_k] M^2(s_k) + \gamma [s_k^h - \tau_{1,k}] (M(s_k) - 1)^2 \right) \\
&\quad \times \mathbb{1}_{\{\tau_{1,k} - s_k \leq s_k^h - s_k\}} \mathbb{E} \left[\mathbb{1}_{\{\Gamma = \Phi_{i,j}\}} \mathbb{1}_{\{\tau_{2,k} - \tau_{1,k} > s_k^h - \tau_{1,k}\}} \middle| \sigma(\tau_{1,k}) \vee \widetilde{\mathcal{F}}_{s_k} \right].
\end{aligned}$$

Now, using that, given $\Gamma = \Phi_{i,j}$ and $\sigma(\tau_{1,k}) \vee \widetilde{\mathcal{F}}_{s_k}$, $\tau_{2,k} - \tau_{1,k}$ follows an exponential law of parameter $\gamma(M(s_k) - 1)^2 + \gamma(M(s_k) - 1)(M(s_k) - 2)$, we deduce that

$$\begin{aligned} & \mathbb{P} \left(\{\Gamma = \Phi_{i,j}\} \cap \{\tau_{2,k} - \tau_{1,k} > s_k^h - \tau_{1,k}\} \middle| \sigma(\tau_{1,k}) \vee \widetilde{\mathcal{F}}_{s_k} \right) \\ &= \frac{\exp \left(-\gamma \left[(M(s_k) - 1)^2 + (M(s_k) - 1)(M(s_k) - 2) \right] [s_k^h - \tau_{1,k}] \right)}{M^2(s_k) + M(s_k)(M(s_k) - 1)}. \end{aligned}$$

Then using that, given $\sigma(\tau_{1,k}) \vee \widetilde{\mathcal{F}}_{s_k}$, $\tau_{1,k} - s_k$ follows an exponential law of parameter $\gamma M^2(s_k) + \gamma M(s_k)(M(s_k) - 1)$, we deduce that

$$\begin{aligned} & \mathbb{E} \left(\left\langle \xi_{s_k^h}, X_{t_k - s_k^h}^{M(s_k^h)} \right\rangle \exp \left(\gamma \int_0^{s_k^h} M^2(u) du \right) \mathbf{1}_{\{\tau_{1,k} \leq s_k^h, \tau_{2,k} > s_k^h, \Gamma = \Phi_{i,j}\}} \middle| \widetilde{\mathcal{F}}_{s_k} \right) \\ &= \gamma \int_{s_k}^{s_k^h} \left\{ \left\langle T^{(M(s_k)-1)}(s_k^h - r) \Phi_{i,j} T^{(M(s_k))}(r - s_k) \xi_{s_k}, X_{t_k - s_k^h}^{M(s_k)-1} \right\rangle \exp \left(\gamma \int_0^{s_k} M^2(u) du \right) \right. \\ & \quad \left. \times \exp \left(-2\gamma(r - s_k)(M(s_k) - 1) - \gamma(s_k^h - s_k)(M(s_k) - 1)(M(s_k) - 2) \right) \right\} dr. \end{aligned}$$

Similarly,

$$\begin{aligned} & \mathbb{E} \left(\left\langle \xi_{s_k^h}, X_{t_k - s_k^h}^{M(s_k^h)} \right\rangle \exp \left(\gamma \int_0^{s_k^h} M^2(u) du \right) \mathbf{1}_{\{\tau_{1,k} \leq s_k^h, \tau_{2,k} > s_k^h, \Gamma = K_{i,j}\}} \middle| \widetilde{\mathcal{F}}_{s_k} \right) \\ &= \gamma \int_{s_k}^{s_k^h} \left\{ \left\langle T^{(M(s_k)+1)}(s_k^h - r) K_{i,j} T^{(M(s_k))}(r - s_k) \xi_{s_k}, X_{t_k - s_k^h}^{M(s_k)+1} \right\rangle \right. \\ & \quad \left. \times \exp \left(\gamma \int_0^{s_k} M^2(u) du - 2\gamma(r - s_k)M(s_k) - \gamma(s_k^h - s_k)M(s_k)(M(s_k) + 1) \right) \right\} dr. \end{aligned}$$

Fourth term : at least two jumps. Note that, $\mathbb{P} \left(\cdot \middle| \widetilde{\mathcal{F}}_{s_k} \right)$ -a.s., $\tau_{2,k} - \tau_{1,k} \geq E_{s_k}$ where E_{s_k} is an exponential random variable with parameter $\lambda_2(s_k) := \gamma(M(s_k) + 1)^2 + \gamma(M(s_k) + 1)M(s_k)$. We denote by $\lambda_1(s_k) := \gamma(M(s_k) + 1)^2 + \gamma(M(s_k) + 1)M(s_k)$. Using the strong MARKOV property at time $\tau_{1,k}$, we obtain that

$$\mathbb{P} \left(\tau_{2,k} \leq s_k^h \middle| \widetilde{\mathcal{F}}_{s_k} \right) \leq \mathbb{P} \left(\{\tau_{1,k} \leq s_k^h\} \cap \{\tau_{2,k} - \tau_{1,k} \leq s_k^h\} \middle| \widetilde{\mathcal{F}}_{s_k} \right) \leq \lambda_1(s_k) \lambda_2(s_k) [s_k^h - s_k]^2.$$

It follows that there exists a constant $C(k)$ such that,

$$\mathbb{E} \left(\left\langle \xi_{s_k^h}, X_{t_k - s_k^h}^{M(s_k^h)} \right\rangle \exp \left(\gamma \int_0^{s_k^h} M^2(u) du \right) \mathbf{1}_{\{\tau_{2,k} \leq s_k^h\}} \middle| \widetilde{\mathcal{F}}_{s_k} \right) \leq C(k)h^2.$$

Step 3. Second term of (55). It follows from the MILD formulation of Proposition 6.3

that

$$\begin{aligned}
& \mathbb{E} \left(\left\langle \xi_{s_k}, X_{t_k - s_k}^{M(s_k)} \right\rangle \exp \left(\gamma \int_0^{s_k} M^2(u) du \right) \middle| \widetilde{\mathcal{F}}_{s_k} \right) \\
&= \mathbb{E} \left(\left\langle T^{(M(s_k))} (s_k^h - s_k) \xi_{s_k}, X_{t_k - s_k^h}^{M(s_k)} \right\rangle \exp \left(\gamma \int_0^{s_k} M^2(u) du \right) \middle| \widetilde{\mathcal{F}}_{s_k} \right) \\
&+ \gamma \sum_{\substack{i,j=1 \\ i \neq j}}^{M(s_k)} \mathbb{E} \left(\int_0^{s_k^h - s_k} \left(\left\langle \Phi_{i,j} T^{(M(s_k))} (r) \xi_{s_k}, X_{t_k - s_k - r}^{M(s_k) - 1} \right\rangle \right. \right. \\
&\quad \left. \left. - \left\langle T^{(M(s_k))} (r) \xi_{s_k}, X_{t_k - s_k - r}^{M(s_k)} \right\rangle \right) dr \exp \left(\gamma \int_0^{s_k} M^2(u) du \right) \middle| \widetilde{\mathcal{F}}_{s_k} \right) \\
&+ \gamma \sum_{i,j=1}^{M(s_k)} \mathbb{E} \left(\int_0^{s_k^h - s_k} \left\langle K_{i,j} T^{(M(s_k))} (r) \xi_{s_k}, X_{t_k - s_k - r}^{M(s_k) + 1} \right\rangle dr \exp \left(\gamma \int_0^{s_k} M^2(u) du \right) \middle| \widetilde{\mathcal{F}}_{s_k} \right).
\end{aligned}$$

Step 4. Conclusion. Putting together all the previous equations, we deduce that

$$\begin{aligned}
& \mathbb{E} \left(\left\langle \xi_{(s+h) \wedge \theta_k}, X_{t \wedge \theta_k - (s+h) \wedge \theta_k}^{M([s+h] \wedge \theta_k)} \right\rangle \exp \left(\gamma \int_0^{[s+h] \wedge \theta_k} M^2(u) du \right) \right) \\
&\quad - \mathbb{E} \left(\left\langle \xi_{s \wedge \theta_k}, X_{t \wedge \theta_k - s \wedge \theta_k}^{M(s \wedge \theta_k)} \right\rangle \exp \left(\gamma \int_0^{s \wedge \theta_k} M^2(u) du \right) \right) \\
&= (\mathbf{A}) + (\mathbf{B}) + (\mathbf{C}) + (\mathbf{D}) + (\mathbf{E}) + O(h^2),
\end{aligned}$$

where

$$\begin{aligned}
(\mathbf{A}) &= \mathbb{E} \left(\left\langle T^{(M(s_k))} (s_k^h - s_k) \xi_{s_k}, X_{t_k - s_k^h}^{M(s_k)} \right\rangle \right. \\
&\quad \times \exp \left(\gamma \int_0^{s_k} M^2(u) du - \gamma [s_k^h - s_k] M(s_k) (M(s_k) - 1) \right) \\
&\quad \left. + \gamma \mathbb{E} \left(\int_0^{s_k^h - s_k} \sum_{\substack{i,j=1 \\ i \neq j}}^{M(s_k)} \left\langle T^{(M(s_k))} (r) \xi_{s_k}, X_{t_k - s_k - r}^{M(s_k)} \right\rangle dr \exp \left(\gamma \int_0^{s_k} M^2(u) du \right) \right) \right), \\
(\mathbf{B}) &= \gamma \mathbb{E} \left(\sum_{\substack{i,j=1 \\ i \neq j}}^{M(s_k)} \int_0^{s_k^h - s_k} \left\{ \left\langle T^{(M(s_k) - 1)} (s_k^h - s_k - r) \Phi_{i,j} T^{(M(s_k))} (r) \xi_{s_k}, X_{t_k - s_k^h}^{M(s_k) - 1} \right\rangle \right. \right. \\
&\quad \left. \left. - \left\langle T^{(M(s_k) - 1)} (0) \Phi_{i,j} T^{(M(s_k))} (r) \xi_{s_k}, X_{t_k - s_k - r}^{M(s_k) - 1} \right\rangle \right\} \exp \left(\gamma \int_0^{s_k} M^2(u) du \right) \right), \\
(\mathbf{C}) &= \gamma \mathbb{E} \left(\sum_{i,j=1}^{M(s_k)} \int_0^{s_k^h - s_k} \left\{ \left\langle T^{(M(s_k) + 1)} (s_k^h - s_k - r) K_{i,j} T^{(M(s_k))} (r) \xi_{s_k}, X_{t_k - s_k^h}^{M(s_k) + 1} \right\rangle \right. \right. \\
&\quad \left. \left. - \left\langle T^{(M(s_k) + 1)} (0) K_{i,j} T^{(M(s_k))} (r) \xi_{s_k}, X_{t_k - s_k - r}^{M(s_k) + 1} \right\rangle \right\} \exp \left(\gamma \int_0^{s_k} M^2(u) du \right) \right),
\end{aligned}$$

$$\begin{aligned}
(\mathbf{D}) &= \gamma \mathbb{E} \left(\sum_{\substack{i,j=1 \\ i \neq j}}^{M(s_k)} \int_0^{s_k^h - s_k} \left\{ \left\langle T^{(M(s_k)-1)}(s_k^h - s_k - r) \Phi_{i,j} T^{(M(s_k))}(r) \xi_{s_k}, X_{t_k - s_k^h}^{M(s_k)-1} \right\rangle \right. \right. \\
&\quad \left. \left. \times \exp \left(-2\gamma r [M(s_k) - 1] - \gamma (s_k^h - s_k) [M(s_k) - 1] [M(s_k) - 2] \right) \right\} dr \right), \\
(\mathbf{E}) &= \gamma \mathbb{E} \left(\sum_{i,j=1}^{M(s_k)} \int_0^{s_k^h - s_k} \left\{ \left\langle T^{(M(s_k)+1)}(s_k^h - s_k - r) K_{i,j} T^{(M(s_k))}(r) \xi_{s_k}, X_{t_k - s_k^h}^{M(s_k)+1} \right\rangle \right. \right. \\
&\quad \left. \left. \times \exp \left(-2\gamma r M(s_k) - \gamma (s_k^h - s_k) M(s_k) [M(s_k) - 1] \right) \right\} dr \right).
\end{aligned}$$

All these terms are $O(h^2)$ uniformly with respect to the other parameters which is sufficient to conclude the proof. This can be proved similarly for each term, so we only give the details for **(A)**. We first notice that when $h \rightarrow 0$,

$$\begin{aligned}
(\mathbf{A}) &= \mathbb{E} \left(M(s_k) (M(s_k) - 1) \int_0^{s_k^h - s_k} \left\{ \left\langle T^{(M(s_k))}(s_k^h - s_k) \xi_{s_k}, X_{t_k - s_k^h}^{M(s_k)} \right\rangle \right. \right. \\
&\quad \left. \left. - \left\langle T^{(M(s_k))}(r) \xi_{s_k}, X_{t_k - s_k - r}^{M(s_k)} \right\rangle \right\} dr \exp \left(\gamma \int_0^{s_k} M^2(u) du \right) \right) + O(h^2).
\end{aligned}$$

By conditioning with respect to $\widetilde{\mathcal{F}}_{s_k}$ in the previous expression and using the MILD formulation of the Proposition 6.3 again we obtain that

$$\begin{aligned}
(\mathbf{A}) &= \gamma \mathbb{E} \left(\exp \left(\gamma \int_0^{s_k} M^2(u) du \right) M(s_k) (M(s_k) - 1) \int_0^{s_k^h - s_k} \left[\int_{t_k - s_k - r}^{t_k - s_k^h} \left\{ \right. \right. \right. \\
&\quad \sum_{\substack{i,j=1 \\ i \neq j}}^{M(s_k)} \left[\left\langle \Phi_{i,j} T^{(M(s_k))}(t_k - s_k - v) \xi_{s_k}, X_v^{M(s_k)-1} \right\rangle - \left\langle T^{(M(s_k))}(t_k - s_k - v) \xi_{s_k}, X_v^{M(s_k)} \right\rangle \right] \\
&\quad \left. \left. \left. + \sum_{i,j=1}^{M(s_k)} \left\langle K_{i,j} T^{(M(s_k))}(t_k - s_k - v) \xi_{s_k}, X_v^{M(s_k)+1} \right\rangle \right\} dv \right] dr \right) + O(h^2).
\end{aligned}$$

Both integrals are on intervals of length at most h . Since all the quantities in the integrals are bounded by definition of the stopping time θ_k , we deduce that $(\mathbf{A}) \underset{h \rightarrow 0}{=} O(h^2)$. \square

A Technical lemmas involved in the existence proof

A.1 Approximation lemma

Lemma A.1. *Let $p \in \mathbb{N}^*$, $\mu, \nu \in \mathcal{M}_1(\mathbb{R})$, $F \in \mathcal{C}_b^3(\mathbb{R}^p, \mathbb{R})$ and $g = (g_1, \dots, g_p)$ where for each $i \in \{1, \dots, p\}$, $g_i \in \mathcal{C}_b^3(\mathbb{R}, \mathbb{R})$. Then,*

$$\begin{aligned}
& F(\langle g_1 \circ \tau_{-\langle \text{id}, \mu \rangle}, \mu \rangle, \dots, \langle g_p \circ \tau_{-\langle \text{id}, \mu \rangle}, \mu \rangle) \\
& \quad - F(\langle g_1 \circ \tau_{-\langle \text{id}, \nu \rangle}, \nu \rangle, \dots, \langle g_p \circ \tau_{-\langle \text{id}, \nu \rangle}, \nu \rangle) \\
&= \sum_{k=1}^p \left\{ \partial_k F(\langle g_1 \circ \tau_{-\langle \text{id}, \nu \rangle}, \nu \rangle, \dots, \langle g_p \circ \tau_{-\langle \text{id}, \nu \rangle}, \nu \rangle) \left(\langle g_k \circ \tau_{-\langle \text{id}, \nu \rangle}, \mu - \nu \rangle \right. \right. \\
& \quad \left. \left. - \langle \text{id}, \mu - \nu \rangle [\langle g'_k \circ \tau_{-\langle \text{id}, \nu \rangle}, \nu \rangle + \langle g'_k \circ \tau_{-\langle \text{id}, \nu \rangle}, \mu - \nu \rangle] \right. \right. \\
& \quad \left. \left. + \frac{1}{2} \langle \text{id}, \mu - \nu \rangle^2 \langle g''_k \circ \tau_{-\langle \text{id}, \nu \rangle}, \nu \rangle \right) \right\} \\
&+ \frac{1}{2} \sum_{i,j=1}^p \left\{ \partial_{ij}^2 F(\langle g_1 \circ \tau_{-\langle \text{id}, \nu \rangle}, \nu \rangle, \dots, \langle g_p \circ \tau_{-\langle \text{id}, \nu \rangle}, \nu \rangle) \left(\langle g_i \circ \tau_{-\langle \text{id}, \nu \rangle}, \mu - \nu \rangle \right. \right. \\
& \quad \times \langle g_j \circ \tau_{-\langle \text{id}, \nu \rangle}, \mu - \nu \rangle - \langle \text{id}, \mu - \nu \rangle \left[\langle g'_j \circ \tau_{-\langle \text{id}, \nu \rangle}, \nu \rangle \langle g_i \circ \tau_{-\langle \text{id}, \nu \rangle}, \mu - \nu \rangle \right. \\
& \quad \left. \left. + \langle g'_i \circ \tau_{-\langle \text{id}, \nu \rangle}, \nu \rangle \langle g_j \circ \tau_{-\langle \text{id}, \nu \rangle}, \mu - \nu \rangle \right. \right. \\
& \quad \left. \left. - \langle g'_i \circ \tau_{-\langle \text{id}, \nu \rangle}, \nu \rangle \langle g'_j \circ \tau_{-\langle \text{id}, \nu \rangle}, \nu \rangle \langle \text{id}, \mu - \nu \rangle \right) \right) \right\} \\
&+ O\left(|\langle \text{id}, \mu - \nu \rangle|^3 + \sum_{k=1}^p \sum_{\ell=0}^2 \left| \langle g_k^{(\ell)} \circ \tau_{-\langle \text{id}, \nu \rangle}, \mu - \nu \rangle \right|^3 \right)
\end{aligned}$$

Proof. The general case $p \in \mathbb{N}^*$ can be proved by a straightforward extension of the proof of the case $p = 1$ which is the only case that we prove. Applying TAYLOR's formula to $g \circ \tau_{-\langle \text{id}, \mu \rangle} = g(\cdot - \langle \text{id}, \mu \rangle)$, we obtain

$$\begin{aligned}
& \langle g \circ \tau_{-\langle \text{id}, \mu \rangle}, \mu \rangle - \langle g \circ \tau_{-\langle \text{id}, \nu \rangle}, \mu \rangle \\
&= \int_{\mathbb{R}} \mu(dx) \left[g'(x - \langle \text{id}, \nu \rangle) \langle \text{id}, \nu - \mu \rangle + \frac{1}{2} g''(x - \langle \text{id}, \nu \rangle) \langle \text{id}, \nu - \mu \rangle^2 + O(\langle \text{id}, \nu - \mu \rangle^3) \right] \\
&= - \langle \text{id}, \mu - \nu \rangle [\langle g' \circ \tau_{-\langle \text{id}, \nu \rangle}, \nu \rangle + \langle g' \circ \tau_{-\langle \text{id}, \nu \rangle}, \mu - \nu \rangle] \\
& \quad + \frac{1}{2} \langle \text{id}, \mu - \nu \rangle^2 [\langle g'' \circ \tau_{-\langle \text{id}, \nu \rangle}, \nu \rangle + \langle g'' \circ \tau_{-\langle \text{id}, \nu \rangle}, \mu - \nu \rangle] + O(\langle \text{id}, \mu - \nu \rangle^3).
\end{aligned}$$

Therefore, we deduce the following approximation:

$$\begin{aligned}
& \langle g \circ \tau_{-\langle \text{id}, \mu \rangle}, \mu \rangle - \langle g \circ \tau_{-\langle \text{id}, \nu \rangle}, \nu \rangle \\
&= \langle g \circ \tau_{-\langle \text{id}, \nu \rangle}, \mu - \nu \rangle - \langle \text{id}, \mu - \nu \rangle [\langle g' \circ \tau_{-\langle \text{id}, \nu \rangle}, \nu \rangle + \langle g' \circ \tau_{-\langle \text{id}, \nu \rangle}, \mu - \nu \rangle] \\
& \quad + \frac{1}{2} \langle \text{id}, \mu - \nu \rangle^2 \langle g'' \circ \tau_{-\langle \text{id}, \nu \rangle}, \nu \rangle + O(|\langle \text{id}, \mu - \nu \rangle|^3 + \langle \text{id}, \mu - \nu \rangle^2 |\langle g'' \circ \tau_{-\langle \text{id}, \nu \rangle}, \mu - \nu \rangle|).
\end{aligned} \tag{A.1}$$

Applying TAYLOR's formula to $F(\langle g \circ \tau_{-\langle \text{id}, \mu \rangle}, \mu \rangle)$, we obtain that

$$\begin{aligned} & F(\langle g \circ \tau_{-\langle \text{id}, \mu \rangle}, \mu \rangle) - F(\langle g \circ \tau_{-\langle \text{id}, \nu \rangle}, \nu \rangle) \\ &= F'(\langle g \circ \tau_{-\langle \text{id}, \nu \rangle}, \nu \rangle) \times [\langle g \circ \tau_{-\langle \text{id}, \mu \rangle}, \mu \rangle - \langle g \circ \tau_{-\langle \text{id}, \nu \rangle}, \nu \rangle] \\ &\quad + \frac{F''(\langle g \circ \tau_{-\langle \text{id}, \nu \rangle}, \nu \rangle)}{2} \times [\langle g \circ \tau_{-\langle \text{id}, \mu \rangle}, \mu \rangle - \langle g \circ \tau_{-\langle \text{id}, \nu \rangle}, \nu \rangle]^2 \\ &\quad + O([\langle g \circ \tau_{-\langle \text{id}, \mu \rangle}, \mu \rangle - \langle g \circ \tau_{-\langle \text{id}, \nu \rangle}, \nu \rangle]^3). \end{aligned}$$

Using (A.1), we deduce that

$$\begin{aligned} & [\langle g \circ \tau_{-\langle \text{id}, \mu \rangle}, \mu \rangle - \langle g \circ \tau_{-\langle \text{id}, \nu \rangle}, \nu \rangle]^2 \\ &= \langle g \circ \tau_{-\langle \text{id}, \nu \rangle}, \mu - \nu \rangle^2 + \langle \text{id}, \mu - \nu \rangle^2 \langle g' \circ \tau_{-\langle \text{id}, \nu \rangle}, \nu \rangle^2 \\ &\quad - 2 \langle g \circ \tau_{-\langle \text{id}, \nu \rangle}, \mu - \nu \rangle \langle \text{id}, \mu - \nu \rangle \langle g' \circ \tau_{-\langle \text{id}, \nu \rangle}, \nu \rangle \\ &\quad + O(|\langle \text{id}, \mu - \nu \rangle|^3 + \langle \text{id}, \mu - \nu \rangle^2 [|\langle g \circ \tau_{-\langle \text{id}, \nu \rangle}, \mu - \nu \rangle| \\ &\quad\quad + |\langle g' \circ \tau_{-\langle \text{id}, \nu \rangle}, \mu - \nu \rangle| + |\langle g'' \circ \tau_{-\langle \text{id}, \nu \rangle}, \mu - \nu \rangle|] \\ &\quad\quad + |\langle \text{id}, \mu - \nu \rangle \langle g \circ \tau_{-\langle \text{id}, \nu \rangle}, \mu - \nu \rangle \langle g' \circ \tau_{-\langle \text{id}, \nu \rangle}, \mu - \nu \rangle|), \end{aligned}$$

and

$$\begin{aligned} & O([\langle g \circ \tau_{-\langle \text{id}, \mu \rangle}, \mu \rangle - \langle g \circ \tau_{-\langle \text{id}, \nu \rangle}, \nu \rangle]^3) \\ &= O(|\langle \text{id}, \mu - \nu \rangle|^3 + \langle \text{id}, \mu - \nu \rangle^2 [|\langle g \circ \tau_{-\langle \text{id}, \nu \rangle}, \mu - \nu \rangle| + |\langle g' \circ \tau_{-\langle \text{id}, \nu \rangle}, \mu - \nu \rangle|] \\ &\quad + |\langle \text{id}, \mu - \nu \rangle| [\langle g \circ \tau_{-\langle \text{id}, \nu \rangle}, \mu - \nu \rangle^2 + \langle g' \circ \tau_{-\langle \text{id}, \nu \rangle}, \mu - \nu \rangle^2] + |\langle g \circ \tau_{-\langle \text{id}, \nu \rangle}, \mu - \nu \rangle|^3). \end{aligned}$$

The announced result follows from YOUNG's inequalities. \square

A.2 Lemma of convergence

Lemma A.2. *We assume that $\mathbb{E}(\langle \text{id}^k, \nu \rangle) < \infty$. We consider for $t \in [0, T]$, an increasing sequence $0 = t_0^n < t_1^n < \dots < t_{p_n}^n = T$ of subdivisions of $[0, T]$ whose mesh tends to 0. Then, for all $k \in \mathbb{N}^*$, $h_1 \in \{1, \text{id}\}$ and $h_2 \in \mathcal{C}_b^2(\mathbb{R}, \mathbb{R})$, we obtain that, in \mathbb{P}_ν^{FV} -probability,*

$$\begin{aligned} (1) \quad & \lim_{n \rightarrow +\infty} \sum_{i=0}^{p_n-1} \int_{t_i^n \wedge t}^{t_{i+1}^n \wedge t} \left| \left\langle h_1 \times \left[h_2 \circ \tau_{-\langle \text{id}, Y_{t_i^n \wedge t} \rangle} - h_2 \circ \tau_{-\langle \text{id}, Y_s \rangle} \right], Y_s \right\rangle^k \right| ds = 0, \\ (2) \quad & \lim_{n \rightarrow +\infty} \sum_{i=0}^{p_n-1} \int_{t_i^n \wedge t}^{t_{i+1}^n \wedge t} | \langle h_1, Y_s \rangle |^k \left| \left\langle h_2 \circ \tau_{-\langle \text{id}, Y_{t_i^n \wedge t} \rangle} - h_2 \circ \tau_{-\langle \text{id}, Y_s \rangle}, Y_s \right\rangle^k \right| ds = 0. \end{aligned}$$

Proof. The two properties can be proved similarly. We only prove the first one. Thanks to Lemma 5.1 (1)(a) and using that h_2 is LIPSCHITZ, there exists a constant C_{Lip} such that

$$\begin{aligned} & \int_{t_i^n \wedge t}^{t_{i+1}^n \wedge t} \left| \left\langle h_1 \times \left[h_2 \circ \tau_{-\langle \text{id}, Y_{t_i^n \wedge t} \rangle} - h_2 \circ \tau_{-\langle \text{id}, Y_s \rangle} \right], Y_s \right\rangle \right|^k ds \\ & \leq \int_{t_i^n \wedge t}^{t_{i+1}^n \wedge t} |\langle h_1, Y_s \rangle|^k \left[C_{\text{Lip}}^k \left| M_s^{\text{id}}(\text{id}) - M_{t_i^n \wedge t}^{\text{id}}(\text{id}) \right| \wedge (2 \|h_2\|_\infty)^k \right] ds. \end{aligned}$$

If $h_1 = 1$, the dominated convergence theorem allows us to conclude the proof. If $h_1 = \text{id}$, using that $\sup_{t \in [0, T]} |\langle \text{id}, \nu \rangle| < \infty$ \mathbb{P}_ν^{FV} -a.s. by Lemma 5.1 (1)(b), we can also apply the dominated convergence. \square

A.3 Control of error terms

Lemma A.3. *Let $t > 0$ be fixed and assume that $\mathbb{E}(\langle \text{id}^2, \nu \rangle) < \infty$. Let $j \in \{0, 1, 2\}$ and $g \in \mathcal{C}_b^4(\mathbb{R}, \mathbb{R})$ fixed. The sequences*

$$\begin{aligned} (1) \quad & \left(\sum_{i=0}^{p_n-1} \left| M_{t_{i+1}^n \wedge t}^{\text{id}}(\text{id}) - M_{t_i^n \wedge t}^{\text{id}}(\text{id}) \right|^3 \right)_{n \in \mathbb{N}} \\ (2) \quad & \left(\sum_{i=0}^{p_n-1} \left| M_{t_{i+1}^n \wedge t}^{\text{id}} \left(g^{(j)} \circ \tau_{-\langle \text{id}, Y_{t_i^n \wedge t} \rangle} \right) - M_{t_i^n \wedge t}^{\text{id}} \left(g^{(j)} \circ \tau_{-\langle \text{id}, Y_{t_i^n \wedge t} \rangle} \right) \right|^3 \right)_{n \in \mathbb{N}} \end{aligned}$$

converge to 0 in \mathbb{P}_ν^{FV} -probability.

Proof. Step 1. Proof of (1). Let $\varepsilon > 0$ and $t \geq 0$ fixed. Let $A > 0$ to be determined later. We introduce the stopping time

$$\tau_A := \inf \left\{ t \geq 0 \mid \langle \text{id}^2, Y_t \rangle - \langle \text{id}, Y_t \rangle^2 \geq A \right\}$$

which satisfies almost surely $\lim_{A \rightarrow +\infty} \tau_A = +\infty$ by Lemma 5.1. Then, using MARKOV's inequality, we obtain that

$$\begin{aligned} & \mathbb{P}_\nu^{FV} \left(\sum_{i=0}^{p_n-1} \left| M_{t_{i+1}^n \wedge t}^{\text{id}}(\text{id}) - M_{t_i^n \wedge t}^{\text{id}}(\text{id}) \right|^3 > \varepsilon \right) \\ & \leq \mathbb{P}_\nu^{FV}(\tau_A \leq t) + \mathbb{P}_\nu^{FV} \left(\left\{ \tau_A > t \right\} \cap \left\{ \sum_{i=0}^{p_n-1} \left| M_{t_{i+1}^n \wedge t}^{\text{id}}(\text{id}) - M_{t_i^n \wedge t}^{\text{id}}(\text{id}) \right|^3 > \varepsilon \right\} \right) \\ & \leq \mathbb{P}_\nu^{FV}(\tau_A \leq t) + \frac{1}{\varepsilon} \sum_{i=0}^{p_n-1} \mathbb{E} \left(\left| M_{t_{i+1}^n \wedge t \wedge \tau_A}^{\text{id}}(\text{id}) - M_{t_i^n \wedge t}^{\text{id}}(\text{id}) \right|^3 \right). \end{aligned}$$

From the definition of τ_A , we obtain for all $s \in [t_i^n \wedge t, t_{i+1}^n \wedge t]$, $\left| M_{s \wedge \tau_A}^{\text{id}}(\text{id}) - M_{t_i^n \wedge t}^{\text{id}}(\text{id}) \right|^3$ is bounded and $\langle M^{\text{id}}(\text{id}) \rangle_{t \wedge \tau_A}$ is $2\gamma A^2$ -LIPSCHITZ. Thanks to the BURKOLDER-DAVIS-GUNDY

inequality and Lemma 5.1 (2), there exists a constant C_1 such that

$$\begin{aligned} \mathbb{E} \left(\left| M_{t_{i+1}^n \wedge t \wedge \tau_A}^{\text{id}}(\text{id}) - M_{t_i^n \wedge t}^{\text{id}}(\text{id}) \right|^3 \right) &\leq C_1 \mathbb{E} \left(\left[\langle M^{\text{id}}(\text{id}) \rangle_{t_{i+1}^n \wedge t \wedge \tau_A} - \langle M^{\text{id}}(\text{id}) \rangle_{t_i^n \wedge t} \right]^{\frac{3}{2}} \right) \\ &\leq C_1 (2\gamma A^2)^{\frac{3}{2}} (t_{i+1}^n \wedge t - t_i^n \wedge t)^{\frac{3}{2}}. \end{aligned}$$

Therefore, if we choose A such that $\mathbb{P}_\nu^{FV}(\tau_A \leq t) \leq \frac{\varepsilon}{2}$, and $n_0 \in \mathbb{N}$ such that for all $n \geq n_0$,

$$\sqrt{\sup_{i \in [0, p_n - 1]} |t_{i+1}^n \wedge t - t_i^n \wedge t|} \leq \frac{\varepsilon^2}{2C_1 (2\gamma A^2)^{\frac{3}{2}} t},$$

we obtain that

$$\begin{aligned} \mathbb{P}_\nu^{FV} \left(\sum_{i=0}^{p_n-1} \left| M_{t_{i+1}^n \wedge t}^{\text{id}}(\text{id}) - M_{t_i^n \wedge t}^{\text{id}}(\text{id}) \right|^3 > \varepsilon \right) \\ \leq \mathbb{P}_\nu^{FV}(\tau_A \leq t) + \frac{C_1 (2\gamma A^2)^{\frac{3}{2}}}{\varepsilon} t \sqrt{\sup_{i \in [0, p_n - 1]} |t_{i+1}^n \wedge t - t_i^n \wedge t|} \\ \leq \varepsilon, \end{aligned}$$

and the first announced result follows.

Step 2. Proof of (2). In similar way as previously, we obtain that

$$\begin{aligned} \mathbb{P}_\nu^{FV} \left(\sum_{i=0}^{p_n-1} \left| M_{t_{i+1}^n \wedge t}^{\text{id}} \left(g^{(j)} \circ \tau_{-\langle \text{id}, Y_{t_i^n \wedge t}^n \rangle} \right) - M_{t_i^n \wedge t}^{\text{id}} \left(g^{(j)} \circ \tau_{-\langle \text{id}, Y_{t_i^n \wedge t}^n \rangle} \right) \right|^3 > \varepsilon \right) \\ \leq \frac{1}{\varepsilon} \sum_{i=0}^{p_n-1} \mathbb{E} \left(\left| M_{t_{i+1}^n \wedge t}^{\text{id}} \left(g^{(j)} \circ \tau_{-\langle \text{id}, Y_{t_i^n \wedge t}^n \rangle} \right) - M_{t_i^n \wedge t}^{\text{id}} \left(g^{(j)} \circ \tau_{-\langle \text{id}, Y_{t_i^n \wedge t}^n \rangle} \right) \right|^3 \right) \\ \leq \frac{C_1 \left(2\gamma \|g^{(j)}\|_\infty^2 \right)^{\frac{3}{2}}}{\varepsilon} t \sqrt{\sup_{i \in [0, p_n - 1]} |t_{i+1}^n \wedge t - t_i^n \wedge t|}, \end{aligned}$$

which converges to 0 when $n \rightarrow +\infty$. □

Funding. This work was partially supported by the Chair ‘‘Modélisation Mathématique et Biodiversité’’ of Veolia Environnement-Ecole Polytechnique-Museum National d’Histoire Naturelle-Fondation X.

References

- [1] V. Bansaye and S. Méléard. Stochastic models for structured populations - Scaling limits and long time behavior. Springer International Publishing, Cham, 2015.
- [2] P. Billingsley. Convergence of Probability Measures. Wiley Series in Probability and Statistics, Second edition. John Wiley & Sons, Inc., Hoboken, NJ, USA, 1999.

- [3] N. Champagnat. A microscopic interpretation for adaptive dynamics trait substitution sequence models. *Stochastic Processes and their Applications*, 116(8):1127–1160, 2006.
- [4] N. Champagnat and V. Hass. Convergence of individual-based models with small and frequent mutations to the canonical equation of adaptive dynamics. Work in progress.
- [5] N. Champagnat, P.-E. Jabin, and S. Méléard. Adaptation in a stochastic multi-resources chemostat model. *Journal de Mathématiques Pures et Appliquées*, 101(6):755–788, 2014.
- [6] N. Champagnat and S. Méléard. Polymorphic evolution sequence and evolutionary branching. *Probability Theory and Related Fields*, 151(1-2):45–94, 2011.
- [7] D.A. Dawson. Geostochastic calculus. *Canadian Journal of Statistics*, 6(2):143–168, 1978.
- [8] D.A. Dawson. Measure-Valued Markov processes. P.-L. Hennequin (editor) *École d’Été de probabilités de Saint-Flour XXI. Lecture Notes in Mathematics*, Vol. 1541 : 1-260, 1993.
- [9] D.A. Dawson and K. Hochberg. Wandering random measures in the Fleming-Viot model. *The Annals of Probability*, 10(3):554–580, 1982.
- [10] D.A. Dawson and P. March. Resolvent Estimates for Fleming-Viot Operators and Uniqueness of Solutions to Related Martingale Problems. *Journal of Functional Analysis*, 132(2):417–472, 1995.
- [11] U. Dieckmann and R. Law. The dynamical theory of coevolution: a derivation from stochastic ecological processes. *Journal of Mathematical Biology*, 34(5-6):579–612, 1996.
- [12] O. Diekmann, P.-E. Jabin, S. Mischler, and B. Perthame. The dynamics of adaptation: An illuminating example and a Hamilton-Jacobi approach. *Theoretical Population Biology*, 67(4):257–271, 2005.
- [13] P. Donnelly and T.G. Kurtz. A countable representation of the Fleming-Viot measure-valued diffusion. *The Annals of Probability*, 24(2), 1996.
- [14] P. Donnelly and T.G. Kurtz. Particle Representations for Measure-Valued Population Models. *The Annals of Probability*, 27(1), 1999.
- [15] R. M. Dudley. Real analysis and probability. Number 74 in Cambridge studies in advanced mathematics. Cambridge University Press, Cambridge; New York, 2002.
- [16] A. Etheridge. An Introduction to Superprocesses, volume 20 of University Lecture Series. American Mathematical Society, Providence, RI, 2000.
- [17] A. Etheridge. Some Mathematical Models from Population Genetics, volume 2012 of Lecture Notes in Mathematics. Springer Berlin Heidelberg, Berlin, Heidelberg, 2011.
- [18] A. Etheridge and T. G. Kurtz. Genealogical constructions of population models. *The Annals of Probability*, 47(4):1827–1910, 2019.
- [19] S. N. Ethier and T. G. Kurtz. The infinitely-many-neutral-alleles diffusion model. *Advances in Applied Probability*, 13(3):429–452, 1981.
- [20] S. N. Ethier and T. G. Kurtz. The Infinitely-Many-Alleles Model with Selection as a Measure-Valued Diffusion. In *Stochastic Methods in Biology*, volume 70, pages 72–86. Springer Berlin Heidelberg, Berlin, Heidelberg, 1987.
- [21] S. N. Ethier and T. G. Kurtz. Coupling and ergodic theorems for Fleming-Viot processes. *The Annals of Probability*, 26(2), 1998.
- [22] S. N. Ethier and T.G. Kurtz. Fleming-Viot Processes in Population Genetics. *SIAM Journal on Control and Optimization*, 31(2):345–386, 1993.

- [23] S. N. Ethier and T. Shiga. A Fleming-Viot Process with Unbounded Selection, II. In Z. Hou, J.A. Filar, and A. Chen, editors, *Markov Processes and Controlled Markov Chains*, pages 305–322. Springer US, Boston, MA, 2002.
- [24] S.N. Ethier and T. G. Kurtz. Convergence to Fleming-Viot processes in the weak atomic topology. *Stochastic Processes and their Applications*, 54(1):1–27, 1994.
- [25] S.N. Ethier and T.G. Kurtz. *Markov Processes*. Wiley Series in Probability and Statistics. John Wiley & Sons, Inc., Hoboken, NJ, USA, 1986.
- [26] W. Fleming and M. Viot. Some measure-valued Markov processes in population genetics theory. *Indiana University Mathematics Journal*, 28(5):817–843, 1979.
- [27] H. He. Fleming-Viot processes in an environment. *Infinite Dimensional Analysis, Quantum Probability and Related Topics*, 13(03):489–509, 2010.
- [28] N. Ikeda and S. Watanabe. *Stochastic Differential Equations and Diffusion Processes*, volume 24 of North-Holland Mathematical Library, Second edition. North-Holland Pub. Co., Japan, 1989.
- [29] I. Karatzas and S.E. Shreve. *Brownian Motion and Stochastic Calculus*, volume 113 of Graduate Texts in Mathematics, Second edition. Springer New York, New York, NY, 1998.
- [30] H. Kesten. The number of alleles in electrophoretic experiments. *Theoretical Population Biology*, 18(2):290–294, 1980.
- [31] J.F.C. Kingman. Coherent random walks arising in some genetical models. *Proceedings of the Royal Society of London. A. Mathematical and Physical Sciences*, 351(1664):19–31, 1976.
- [32] A. Klenke. *Probability Theory: A Comprehensive Course*. Universitext. Springer, New York, 2013.
- [33] T.G. Kurtz. Averaging for martingale problems and stochastic approximation. In I. Karatzas and D. Ocone, editors, *Applied Stochastic Analysis, Lecture Notes in Control and Information Sciences*, volume 177, pages 186–209. Springer-Verlag, Berlin/Heidelberg, 1992.
- [34] Z. Li, T. Shiga, and L. Yao. A Reversibility Problem for Fleming-Viot Processes. *Electronic Communications in Probability*, 4, 1999.
- [35] T. Lindvall. *Lectures on the Coupling Method*. Dover Publications, Inc, Mineola, N.Y, 2002.
- [36] H. Liu and X. Zhou. Some support properties for a class of Λ -Fleming-Viot processes. *Annales de l’Institut Henri Poincaré, Probabilités et Statistiques*, 51(3):1076–1101, 2015.
- [37] A. Lorz, S. Mirrahimi, and B. Perthame. Dirac Mass Dynamics in Multidimensional Nonlocal Parabolic Equations. *Communications in Partial Differential Equations*, Taylor & Francis, 36(6):1071–1098, 2011.
- [38] J.A.J. Metz, S.A.H. Geritz, G. Meszner, and al. Adaptive dynamics: A geometrical study of the consequences of nearly faithful reproduction. Working papers, International Institute for Applied Systems Analysis, 1995.
- [39] P.A.P. Moran. Wandering distributions and the electrophoretic profile. *Theoretical Population Biology*, 8(3):318–330, 1975.
- [40] P.A.P. Moran. Wandering distributions and the electrophoretic profile. II. *Theoretical Population Biology*, 10(2):145–149, 1976.
- [41] T. Ohta and M. Kimura. A model of mutation appropriate to estimate the number of electrophoretically detectable alleles in a finite population. *Genetical Research*, 22(2):201–204, 1973.

- [42] T. Ohta and M. Kimura. Simulation studies on electrophoretically detectable genetic variability in a finite population. *Genetics*, 76(3):615–624, 1974.
- [43] L. Overbeck. Uniqueness of the Fleming-Viot process with selection. In Z.M. Ma, M. Röckner, and J.A. Yan, editors, *Dirichlet Forms and Stochastic Processes*. De Gruyter, Berlin, New York, 1995.
- [44] L. Overbeck, M. Rockner, and B. Schmuland. An Analytic Approach to Fleming-Viot Processes with Interactive Selection. *The Annals of Probability*, 23(1), 1995.
- [45] G. Papanicolaou, D. Stroock, and S. Varadhan. *Martingale Approach to Some Limit Theorems. Statistical Mechanics Dynamical Systems and Duke Turbulence Conference*, Duke University Series, Vol 3, Durham, N.C., 1977.
- [46] B. Perthame and G. Barles. Dirac Concentrations in Lotka-Volterra Parabolic PDEs. *Indiana University Mathematics Journal*, 57(7):3275–3301, 2008.
- [47] B. Perthame and M. Gauduchon. Survival thresholds and mortality rates in adaptive dynamics: conciliating deterministic and stochastic simulations. *Mathematical Medicine and Biology: A Journal of the IMA*, 27(3):195–210, 2009.
- [48] W. Rudin. *Real and complex analysis*. Third edition, McGraw-Hill, New York, 2013.
- [49] T. Shiga. Wandering phenomena in infinite-allelic diffusion models. *Advances in Applied Probability*, 14(3):457–483, 1982.
- [50] D. Stroock and S. Varadhan. *Multidimensional diffusion processes*. Number 233 in *Die Grundlehren der mathematischen Wissenschaften in Einzeldarstellungen*. Springer, Berlin Heidelberg, reprint of the 1997 edition edition, 2006.
- [51] D. Waxman and S. Gavrillets. 20 Questions on Adaptive Dynamics: Target review of Adaptive Dynamics. *Journal of Evolutionary Biology*, 18(5):1139–1154, 2005.