



**HAL**  
open science

## Emulation of Radio Technologies for Railways: A Tapped-Delay-Line Channel Model for Tunnels

Hao Qiu, Juan Moreno Garcia-Loygorri, Ke Guan, Danping He, Ziheng Xu,  
Bo Ai, Marion Berbineau

► **To cite this version:**

Hao Qiu, Juan Moreno Garcia-Loygorri, Ke Guan, Danping He, Ziheng Xu, et al.. Emulation of Radio Technologies for Railways: A Tapped-Delay-Line Channel Model for Tunnels. *IEEE Access*, 2021, 9, pp1512-1523. 10.1109/ACCESS.2020.3046852 . hal-03592589

**HAL Id: hal-03592589**

**<https://hal.science/hal-03592589>**

Submitted on 1 Mar 2022

**HAL** is a multi-disciplinary open access archive for the deposit and dissemination of scientific research documents, whether they are published or not. The documents may come from teaching and research institutions in France or abroad, or from public or private research centers.

L'archive ouverte pluridisciplinaire **HAL**, est destinée au dépôt et à la diffusion de documents scientifiques de niveau recherche, publiés ou non, émanant des établissements d'enseignement et de recherche français ou étrangers, des laboratoires publics ou privés.



Distributed under a Creative Commons Attribution 4.0 International License

Date of publication xxxx 00, 0000, date of current version xxxx 00, 0000.

Digital Object Identifier 10.1109/ACCESS.2017.DOI

# Emulation of Radio Technologies for Railways: a Tapped-Delay-Line Channel Model for Tunnels

HAO QIU<sup>1,2</sup>, (STUDENT MEMBER, IEEE), JUAN MORENO GARCÍA-LOYGORRI<sup>3,4</sup>, (SENIOR MEMBER, IEEE), KE GUAN<sup>1,2</sup>, (SENIOR MEMBER, IEEE), DANPING HE<sup>1,2</sup>, (MEMBER, IEEE), ZIHENG XU<sup>1,2</sup>, BO AI<sup>1,2</sup>, (SENIOR MEMBER, IEEE), MARION BERBINEAU<sup>5</sup>, (MEMBER, IEEE).

<sup>1</sup>State Key Laboratory of Rail Traffic Control and Safety, Beijing Jiaotong University, 100044, Beijing, China

<sup>2</sup>Beijing Engineering Research Center of High-speed Railway Broadband Mobile Communications, 100044, Beijing, China

<sup>3</sup>Engineering and R&D Department of Madrid Metro, Madrid, Spain

<sup>4</sup>IAC Department of the Universidad Politécnica de Madrid (UPM), Madrid, Spain

<sup>5</sup>COSYS-LEOST, Université Gustave Eiffel, France

Corresponding author: Ke Guan (e-mail: kguan@bjtu.edu.cn).

This work is supported by Fundamental Research Funds for the Central Universities (No. 2020JBZD005), the NSFC under Grant (61771036, U1834210, 61901029, and 61725101), State Key Lab of Rail Traffic Control and Safety Project under Grant RCS2020ZZ005, and Project manager EMULRADIO4RAIL (Grant Agreement number: 826152).

**ABSTRACT** Radio access technologies (RATs) are a key topic in railways, enabling them a better service rendering in terms of shorter headways between trains, higher safety levels and higher customer satisfaction. Very often, these railway RATs need a lot of time to be developed, tested and put into service, which implies a lack of efficiency and bottlenecks in the evolution of railway systems. To solve this situation, an emulation platform that considers both the physical layer and the network (this is, able to emulate the end-to-end chain) is envisaged in the EmulRadio4Rail project. Therefore, the physical layer of many railway scenarios must be emulated, which is a remarkable challenge because railways are very diverse. We see Tapped-Delay Lines (TDL) models as the most efficient way for emulation with the available hardware. In the literature, there are many TDL-based channel models for all the scenarios we considered but one: tunnels. Therefore, in order to fill this gap, we develop a novel TDL model for railway tunnels, considering the impact of the rolling stock (both high-speed railway (HSR) and subway trains). The proposed model allows the full characterization of this scenario in terms of power-delay-profile (PDP), Doppler spectrum and fading characteristics.

**INDEX TERMS** Channel modelling, propagation, railway communications, tapped-delay-line models, tunnel.

## I. INTRODUCTION

IN railways, communication systems are becoming more and more necessary now than ever due to the increasing demand for more punctual train services, shorter headways between trains, faster connections to the Internet for passengers and massive sensor networks onboard the trains, among many others [1], [2]. However, recent history has proven that the development of these technologies is very slow (*i.e.* Global System for Mobile Communications – Railway (GSM-R), the dominant radio access technology in railways is almost 20 years old [1]) because the difficulties to do tests on real environments and, on a lesser extent, the absence of economies of scale on a niche market like this. The first problem is targeted by the development of a radio channel emulator which is the main purpose of the EmulRadio4Rail

project [3], within the European Shift2Rail initiative.

This radio channel emulator should allow physical connections from the radio access technologies (RATs) being tested on both sides [4]–[7], in order to emulate the whole end-to-end communication system (both the physical and the network layer). The Emulradio4rail platform supports multiple emulation technologies such as Long Term Evolution (LTE) [8], Wireless Fidelity (Wi-Fi), the fifth-generation mobile communication system (5G) and SatComs [3]. Therefore, with this new tool, the validation process of both existing and new RATs will speed up and some of the current shortcomings of transmission-based signaling technologies like Communication Based Train Control System (CBTC) and European Train Control System (ETCS) will be finally overcome. This will be done in accordance of the Future Railway Mobile

Communications System (FRMCS), an initiative that will enable a theoretically easy migration from GSM-R, increase throughput, provide both security and safety functionalities and improved resilience to interferences [9].

In order to validate the FRMCS technologies, an exhaustive process is needed for many different railway applications, like high-speed railway (HSR), subways, tramways, mainline, *etc.*, as well as particular scenarios such as cuttings, tunnels, urban areas, hilly, viaducts and a large etcetera. Railways are very diverse all over the world and a technology aimed to work for the whole sector must address this complexity. Therefore, the RAT emulator must consider many different scenarios to provide support for RATs. The way to do this is to identify reliable and accurate physical-layer channel models for all of them [10]. Due to the available hardware in the Emulradio4rail project and also for efficiency-related considerations that will be discussed in Section II, the models that were decided to be emulated in the project were the tapped-delay line (TDL) based models [11]. As Train-to-Ground (T2G) is the main application of this project, an exhaustive research of published TDL-based models was carried out. Several were found in many different scenarios (as we will see in detail later) but not for tunnels. There are many measurement campaigns and channel models for tunnels [12]–[17] but no one of them is TDL-based. The reason for this is that in this environment there are many multipath components (MPC) very close together and, in order to provide an accurate and useful TDL-based channel model, the needed resolution in the time-domain is very demanding (around 1 ns), which implies 1 GHz bandwidth for the channel sounder [18], [19]. These models are relevant contributions to the research in this field but they are not useful for our channel emulator and, therefore, not useful to validate our new TDL channel model, at least not completely. For example, one of the previous papers [20] develops a model based on measurements in the field but also some validation from ray-tracing measurements. The other railway-related environments (rural, hilly, cutting and viaduct) are outdoor and the associated MPCs are spaced microseconds instead of nanoseconds typical of indoor environments like tunnels. Consequently, in order to fulfill all the requirements for the emulation platform, we decided to retrieve a channel model from ray-tracing (RT) simulations for two different environments: HSR and subway tunnels.

For all of this, the main contributions of this article are twofold:

- Present a TDL-based channel model for railway tunnels, considering as well the influence of the rolling stock in two different setups: large, wide tunnels mainly used for HSR trains and, on the other side, shorter and narrow tunnels for subway trains.
- Identify the influence of the differences between HSR and subway scenarios: size of the tunnel, speed of the train, cross section of the train, *etc.*

The layout of this paper is as follows: in Section II a

brief explanation of the emulation process is provided and a description of the TDL setup is provided as well; in Section III we present the RT simulator and simulation configuration; Section IV reports the methodology of parameter derivation for the TDL models; in Section V we present the obtained models for both types of tunnels and some related discussion on them. Finally, conclusions come in Section VI.

## II. EMULATION OF RADIO ACCESS TECHNOLOGIES IN RAILWAYS

### A. RAILWAY SCENARIOS

The emulation of RATs in railways is troublesome because there is not a single scenario which could be representative of the whole railway world, so we need to consider many different ones. In this research work, we have significantly simplified this diversity and we have considered five different scenarios [21]–[23]:

- Rural: this is the most common one in both mainline and HSR lines [24].
- Viaduct: due to the inability of HSR trains to run on very high ramps, on these lines it is very common to construct viaducts [25], [26].
- Cutting: very useful to decrease the impact on neighboring areas and to ease transitions from and to tunnels [27].
- Hilly terrain: very common in several railway lines around the world [28], [29].
- Tunnel: this is the most likely one in metropolitan railways (subways) but also common in HSR lines [16], [30]. In this scenario we will focus from now on.

Therefore, there is a high chance that every railway line in the world could be characterized as an ensemble of several stretches of the five scenarios considered above. For more details on each one of them, please see Deliverable 1.3 of the EmulRadio4Rail Project [3].

### B. MODELS

After the definition of the scenarios to be considered in the emulation process, we need to explain how this emulation will be performed. The aim of the platform is the end-to-end emulation of the RAT, so both a channel emulator and a network emulator are needed. From now on, we will focus on physical layer aspects only (*i.e.* channel emulator). Details on this platform can be found in our previous papers [12], [31].

Perhaps the most efficient way to emulate a wideband channel is using TDL models [11]. The idea behind this is the following: MPCs arrive at the receiver (Rx) in many different (and discrete) moments in time and each one of them has its own power figure as depicted in Fig. 1. It is assumed that within each tap the spectrum is flat (*i.e.* there is no frequency selectivity) and that all taps are not correlated with each other. Therefore, we can model the channel impulse response (CIR) as the sum of delayed MPCs:

$$h(\tau, t) = \sum_{k=1}^K c_k \delta(\tau - \tau_k) \quad (1)$$

where  $\tau$  is the delay,  $t$  is time,  $c_k$  is the complex coefficient associated to each one of the  $K$  taps. For practical reasons, taps with a power below a threshold are discarded and all MPCs within a time frame are grouped together into a single tap. All these practicalities, including both the tap width and power threshold, are explained in detail in Section IV.

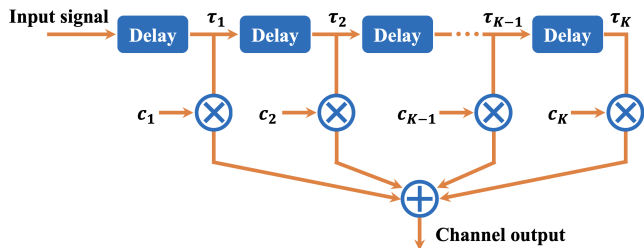

FIGURE 1: Schematic of the Tapped-Delay-Line channel model

Moreover, for each one of the taps we must consider the Doppler spectrum which is the distribution of the frequency shifts associated to each MPC that arrives at the Rx. This is of great importance in vehicular scenarios like railways (in particular, HSR trains can run up to 350 km/h, probably faster in the mid-term). For more details on TDL models any classical text on channel modelling and measurement like for example [11] is a good reference.

Once we had a clear decision on the type of wideband model to be used, we performed an exhaustive literature survey of existing TDL-based models for railway scenarios. The outcome of this survey is that there are many published TDL models for all railway scenarios but not even one for tunnels. We only considered those who included complete information about the Doppler spectrum, speed range, bandwidth, diversity scheme, as well as the more obvious number of taps, delay, frequency range and relative power associated to the taps. Based on this information, we chose the most suitable ones for our emulation platform. All the details of the models and also the assessment on the suitability of each one of them has been already published as a deliverable report in our project [32].

### III. RAY-TRACING AND SIMULATION PROCEDURE

A high-performance computing (HPC) cloud-based ray-tracing simulator (CloudRT) is utilized in this study. The simulator is developed by the State Key Laboratory of Rail Traffic Control and Safety, Beijing Jiaotong University [33]. It is based on the RT technique, which considers the antenna patterns, the existence of the scatterers, locations of transmitter (Tx) and Rx, and various propagation mechanisms. The complete RT simulation process is that the user first needs to reconstruct the three-dimensional (3D) model of the target scenario and the scatterers and define the electromagnetic (EM) parameters of the material, then set the simulation frequency, propagation mechanism, transceiver and scatterers

motion trajectory, antenna type and other parameters, and finally start the RT simulation. After calibrating the geometry of the 3D environment model, and determining the EM parameters of objects/materials and the dominant propagation mechanisms, intensive RT simulations can be conducted with various Tx/Rx deployments as well as various combinations of the objects, which breaks the limits of the measurement [34], [35]. Based on the simulation results, the ray information can be captured, and moreover the TDL model parameters can be extracted. CloudRT has been validated by extensive measurements in various railway environments [36], [37]. In our recent work [38], [39], CloudRT has been validated at 30 GHz and 90 GHz in HSR outdoor and tunnel environments, respectively. More details of CloudRT can be found in <http://www.raytracer.cloud>.

### A. SCENARIO AND SCATTERERS MODELING

In this study, the simplified HSR and subway tunnel scenarios are reconstructed. The cross-sections of the two tunnels in the simulations are shown in Fig. 2.  $W_1$  and  $H$  are the width and height of the tunnel,  $W_2$  is the spacing of rail and  $W_3$  is the width of the rail. As the dual-lines are considered,  $R$  is the distance between the rail and the wall. The length of each tunnel in the simulation is 3000 m. As shown in Fig. 3, two types of train bodies are modeled. The width, height, and length of the HSR train are 2.942 m, 3.70 m and 200 m, respectively. The width, height, and length of the subway train are 2.8 m, 3.25 m and 55.049 m, respectively.

### B. RT SIMULATION CONFIGURATION

In this study, Tx is deployed closed to the wall of the tunnel, and Rx is placed on the top of the train body. As for rectangle HSR tunnel, Tx and Rx are placed at a height of 4.55 m and 4.05 m, respectively. As for rectangular subway tunnel, Tx and Rx are placed at a height of 4.10 m and 3.60 m, respectively. Two antennas are employed at both the Tx and Rx, and the two antenna elements are spaced apart with an inter-distance of  $\lambda/2$ . Considering the tradeoff between computing resource and accuracy, up to 6-order reflection is deployed in this simulation. The specific deployment of the tunnel is shown in Fig. 4. TABLE 1 summarizes the simulation configuration. In Multiple-Input Multiple-Output (MIMO) channel, 4 subchannels are set (as shown in Fig. 5), which constitute the Channel Matrix (2).

$$H = \begin{bmatrix} h_{11} & h_{12} \\ h_{21} & h_{22} \end{bmatrix} \quad (2)$$

The considered materials include the concrete (the tunnel) and metal (the train body and rails). The EM parameters of the mentioned materials are provided by the State Key Laboratory of Rail Traffic Control and Safety, Beijing Jiaotong University, as listed in TABLE 2.

### IV. TDL MODEL PARAMETERS DERIVATION

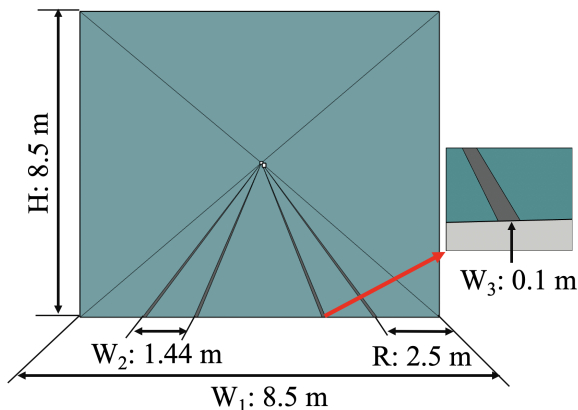

(a) Rectangle HSR tunnel

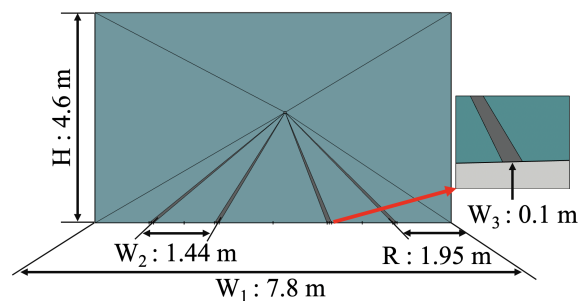

(b) Rectangle subway tunnel

FIGURE 2: Cross-sections of the tunnels

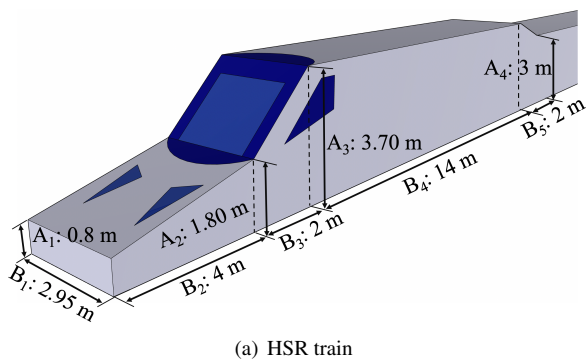

(a) HSR train

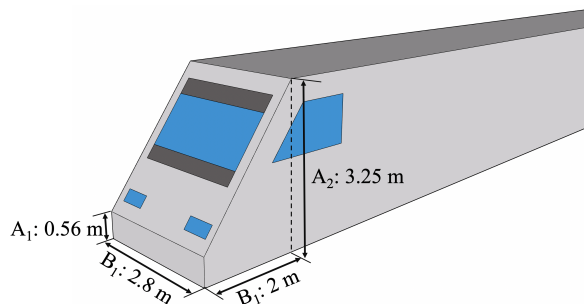

(b) Subway train

FIGURE 3: 3D models of the train bodies in the simulation

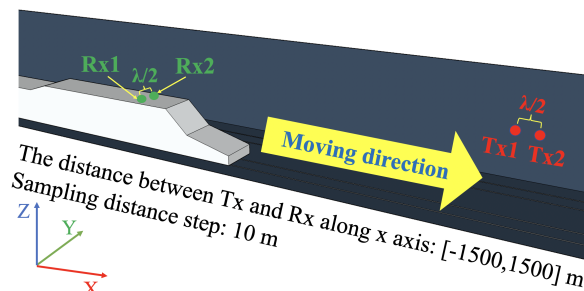

(a) Rectangle HSR tunnel

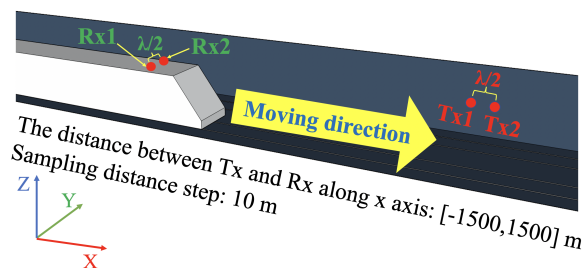

(b) Rectangle subway tunnel

FIGURE 4: The deployment of Tx and Rx antennas in the simulation

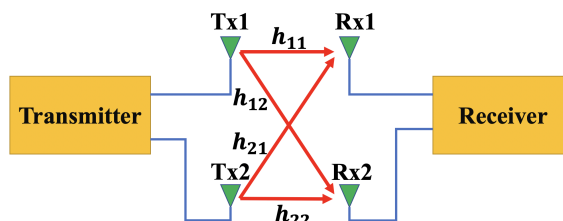

FIGURE 5: MIMO system

#### A. DELAY VALUE AND AVERAGE GAIN OF TAPS

In RT simulations, a pair of Tx/Rx is simulated as a single snapshot with the predefined configurations. A simulation task for an environment model is composed of  $N_s$  snapshots. For each snapshot, the intrinsic results include the number of rays  $N_r$ , ray energy  $E(s, j)$  and the delay of each ray  $\tau(s, j)$  ( $s$  is the index of snapshot, and  $j$  is the index of ray in snapshot  $s$ ) [40]. In order to achieve a time-domain resolution

TABLE 1: Simulation Configuration

Parameter	Value
Center frequency	2.4 GHz
Sampling distance step	10 m
Tx-Rx distance along the x-axis	[-1500, 1500] m
Tx / Rx antenna height in HSR tunnel	4.55 m, 4.05 m
Tx / Rx antenna height in subway tunnel	4.10 m, 3.60 m
Antenna type	Vertical polarized omnidirectional, 0 dBi gain
Element spacing	$\lambda/2$
Propagation mechanism	Direct path, reflection up to the 6 <sup>th</sup> order

TABLE 2: The electromagnetic parameters of main objects

Object Name	Material	$\epsilon_r$	$\tan\delta$
Tunnel	Concrete	7.9	0.082
Rail	Metal	1	$10^7$
Train body	Metal	1	$10^7$

as high as 1 ns for a channel model, there are two types of simulations: the frequency-domain RT simulation with a bandwidth of 1 GHz, or the time-domain RT simulation. Considering that it is not feasible to use 1 GHz bandwidth at such a low frequency band—2.4 GHz in reality for communications, so in order to achieve a sufficiently high multipaths resolution, we use the time-domain RT simulation, because its time resolution is only limited by the number of CPU bits of the computer, and its resolvable time duration is much shorter than the delay difference between two adjacent multipaths in the simulation. As shown in Fig. 6, as an example, numerical multipaths between 48 and 49 ns are with much shorter delay differences than 1 ns but still can be resolvable by the time-domain RT simulation. Since the time-domain resolution of the emulator that is aiming to use our channel model is 8 ns, we combine the multipaths (with the threshold of 60 dB below the strongest ray power) within every  $\Delta\tau$  of 8 ns duration in time-domain to obtain the CIR for further modeling (as shown in Fig. 6), which can be expressed as

$$h(s, m\Delta\tau) = \sum_J E(s, j), J = \{j|m\Delta\tau - \frac{\Delta\tau}{2} \leq \tau(s, j) < m\Delta\tau + \frac{\Delta\tau}{2}, m \geq 0\} \quad (3)$$

where  $m$  is the delay bin index. From which, we define the instantaneous power delay profile (PDP) as

$$P(s, m\Delta\tau) = |h(s, m\Delta\tau)|^2 \quad (4)$$

where  $|\cdot|$  denotes the absolute value. The instantaneous gain for the Tx-Rx link is expressed as

$$P_G(s) = \sum_{m=1}^{M_s} P(s, m\Delta\tau) \quad (5)$$

where  $M_s$  is the number of delay bins in snapshot  $s$ . After removing the mean value of  $P_G(s)$  from  $h(s, m\Delta\tau)$  within the bin, the normalized CIR  $h_{norm}(s, m\Delta\tau)$  can be obtained as

$$h_{norm}(s, m\Delta\tau) = \frac{h(s, m\Delta\tau)}{\sqrt{\frac{1}{N_s} \sum_{s=1}^{N_s} P_G(s)}} \quad (6)$$

This operation is done to reduce the distance dependence and shadowing effects. The instantaneous normalized PDP is expressed as

$$P_{norm}(s, m\Delta\tau) = |h_{norm}(s, m\Delta\tau)|^2 \quad (7)$$

The averaged normalized PDP is then calculated as

$$P_{ave}(m\Delta\tau) = \frac{1}{N_s} \sum_{s=1}^{N_s} P_{norm}(s, m\Delta\tau) \quad (8)$$

The instantaneous and averaged normalized PDPs of  $h_{22}$  for subway tunnel scenario are presented in Fig. 7. For determining the number of taps in the model, the threshold of 30 dB below the strongest tap power is used. Then the averaged normalized power gains and the delay values can be obtained through the delay bin index of the remaining taps. For example, as shown in Fig. 7, the number of taps is 5. The delay bin indexes are  $l = m = 1, 2, 5, 6, 7$ , delay values are calculated from  $l\Delta\tau$ , and averaged power gains,  $P_l = P_{ave}(l\Delta\tau)$ , are from Equation (8).

The normalized amplitude is given by  $|\alpha(s, l\Delta\tau)|$ , which can be calculated as

$$\alpha(s, l\Delta\tau) = \frac{h_{norm}(s, l\Delta\tau)}{\sqrt{P_l}} \quad (9)$$

$$P_l = \frac{1}{N_s} \sum_{s=1}^{N_s} |h_{norm}(s, l\Delta\tau)|^2 \quad (10)$$

where  $l$  is the index of remaining taps.

### B. DOPPLER SPECTRUM OF TAPS

Different normalization methods are used when calculating the Doppler spectrum. For all snapshots, the scalar sum of power of rays  $P(s)$  for snapshot  $s$  is used to normalize the power of effective rays  $P_{norm-ray}(s, j)$ , so that the distance-dependent path loss is removed, which can be expressed as

$$P(s) = \sum_{j=1}^{N_r} |E(s, j)|^2 \quad (11)$$

$$P_{norm-ray}(s, j) = \frac{|E(s, j)|^2}{P(s)} \quad (12)$$

The corresponding Doppler shift of each ray in snapshot  $s$  ( $f_d(s, j)$ ) can be expressed as

$$f_d(s, j) = -f_c \cdot \frac{\vec{v}_{Rx}(s) \cdot \vec{k}(s, j)}{c} \quad (13)$$

where  $f_c$  is the center frequency,  $\vec{v}_{Rx}(s)$  is the velocities of Rx,  $\vec{k}(s, j)$  is the unit vector along the direction of the ray departing from the Tx, scattering point or reflecting point towards the Rx, and  $c$  is the speed of light. Then, all the normalized effective rays and corresponding Doppler shift of each ray in each snapshot are grouped by the time delay interval 8 ns to form several taps of rays.

For each tap, we make statistical analysis for the power and Doppler shift of all the rays within this tap of all the snapshots. Jakes model [41] is used to fit the Doppler spectrum within each tap of all the snapshots, which can be modeled as:

$$S(f_d(s, j)) = \frac{2\sigma^2(s, l)}{\pi f_{max} \sqrt{1 - \frac{f_d(s, j)}{f_{max}}}}, \quad (14)$$

$$\{j|l\Delta\tau - \frac{1}{2}\Delta\tau \leq \tau(s, j) < \Delta\tau + \frac{1}{2}\Delta\tau, l \geq 0\}$$

where  $2\sigma^2(s, l)$  is the scattering component power of tap  $l$  in snapshot  $s$ ,  $f_{max}$  is the maximum Doppler shift of the HSR or subway train.

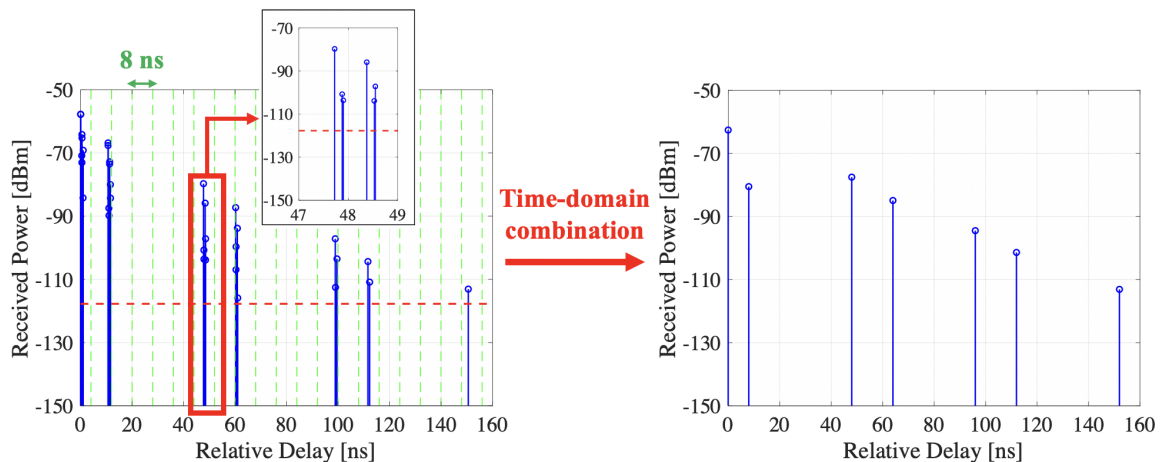

FIGURE 6: An example of combining the multipaths to obtain the CIR in subway tunnel scenario. The 8 ns resolution is given as the green dotted line and the threshold of -60 dB is given as the red dotted line

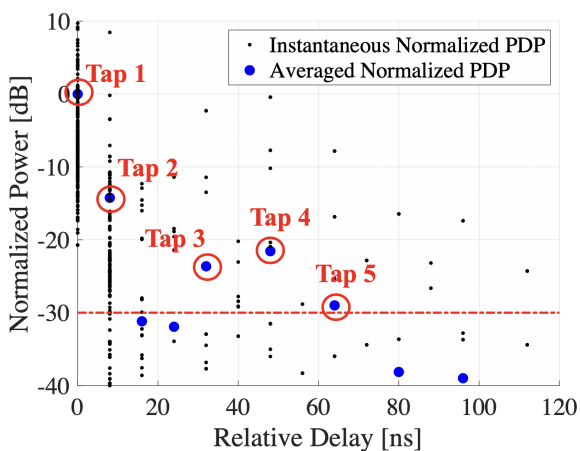

FIGURE 7: An example of instantaneous and averaged normalized PDPs in subway tunnel scenario. The threshold of -30 dB is given as the red dotted line

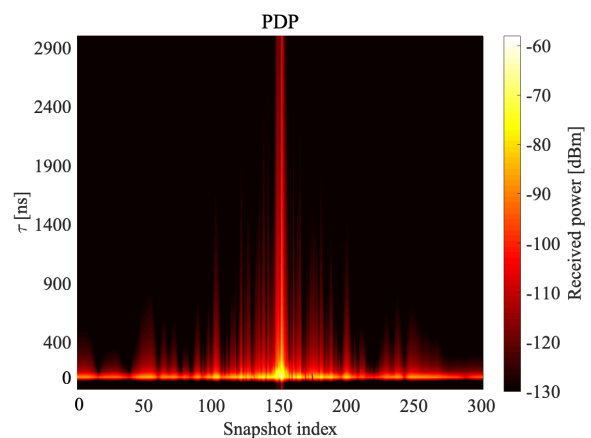

FIGURE 8: PDP for  $h_{11}$  in HSR tunnel

## V. CHANNEL MODELS

In this section, we provide the obtained channel models, in terms of the parameters defined above for both types of tunnels (HSR and subway).

### A. HIGH-SPEED RAILWAY TUNNELS

In Tables 3, 4, 5, and 6, the MIMO 2x2 TDL model for the HSR tunnel is considered. In these tables, we can see both the power and delay associated to each of the 11 taps which comprise each of the subchannels of the 2x2 MIMO channel. The PDP for  $h_{11}$  is shown in Fig. 8. We can see that, as it was expected, the maximum power is related to  $\tau=0$  ns (the graph is not normalized to 0 dB but in absolute received power in dBm) which is the LOS component. Given that the Tx is in the middle of the tunnel, the maximum received power is obtained at the central snapshot of the simulations. Due to the limitation introduced in the time resolution (to 8 ns, as

we discussed in Section IV), the number of MPCs that we are able to solve is limited. In this case, we obtain 11 taps but for subway tunnels, we only get 5 with a significant power figure (the power threshold is set at 30 dB below the maximum tap).

The fading distribution, which fits better to the results is not Rayleigh as it could be foreseen, but Weibull and the values of the distribution parameters for each tap are provided as well in Tables 3-6. Regarding the better fitting to a Weibull distribution rather than to a Rayleigh, the reason is that scatterers are not uniformly distributed in the tunnel because they come from the tunnel walls, which was studied in the literature [42] as well as in some experiments in the field [43] and it is the main assumption related to Weibull Distribution (15).

$$pdf(|\alpha|; \beta_w, \Omega_{weib}) = \frac{\beta_w}{\Omega_{weib}} |\alpha|^{\beta_w-1} \cdot e^{-\frac{|\alpha|^{\beta_w}}{\Omega_{weib}}} \quad (15)$$

The other parameter of this distribution  $\beta_w$  describes the average fading power. As it is known from the first descriptions of the Weibull distribution, Rayleigh distribution is a

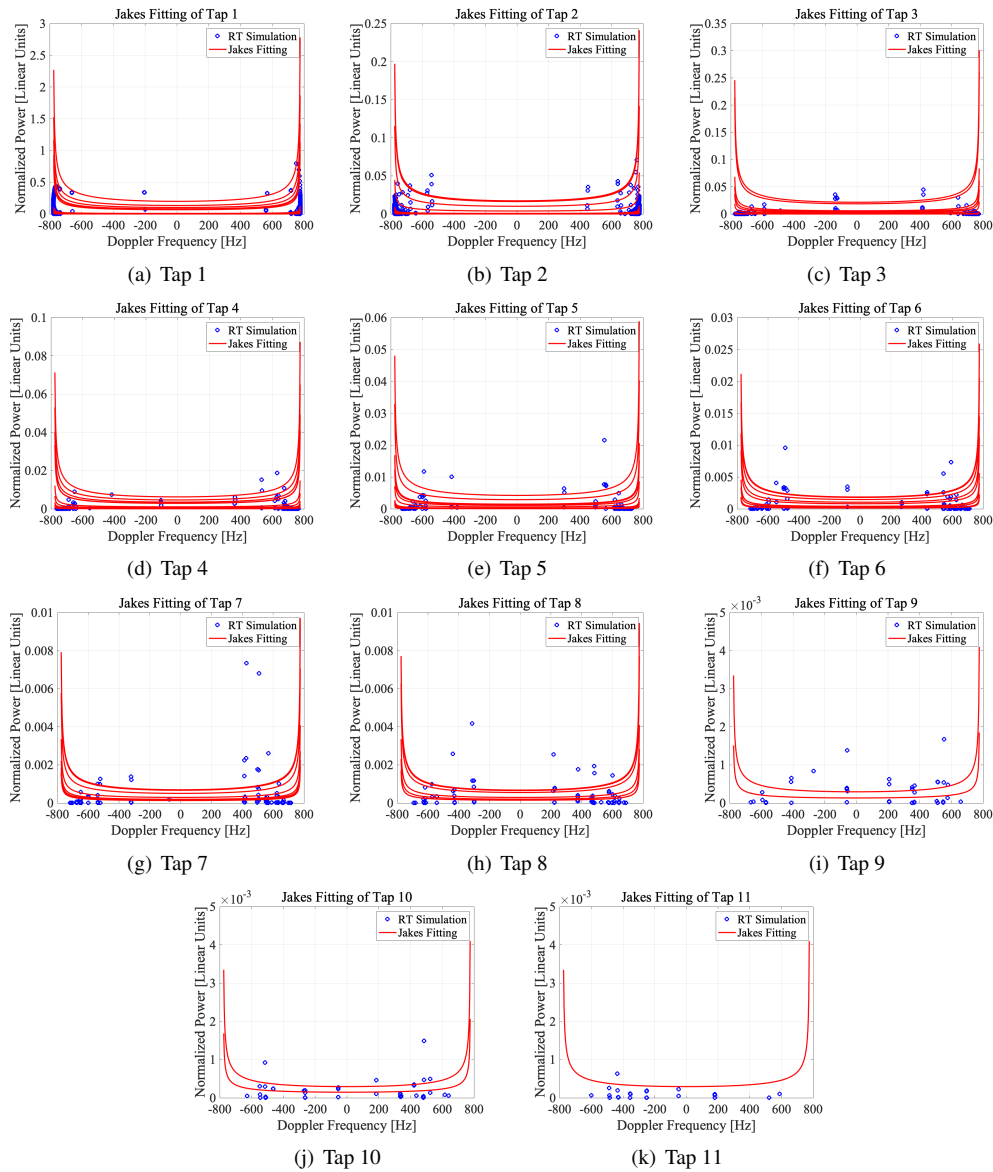

FIGURE 9: The Doppler shift and its Jakes fitting model of the  $h_{11}$  channel for HSR scenario

TABLE 3: TD-L PARAMETERS OF  $h_{11}$  FOR HSR TUNNEL SCENARIO

Tap No.	Delay (ns)	Path Power		Fading Distribution		Doppler Spectrum			
		(lin.)	(dB)	Weibull		Shape	Fitting Model of $\sigma_{Jakes}$	$\mu_{LL}$	$\sigma_{LL}$
				$\beta_\omega$	$\Omega_{weib}$				
1	0	1	0	0.17	0.69	Jakes	Log-Logistic	0.0232	0.2397
2	8	0.2550	-5.9354	0.69	0.38	Jakes	Log-Logistic	-1.1955	0.2263
3	16	0.1645	-7.8387	0.52	0.35	Jakes	Log-Logistic	-1.1289	0.1863
4	24	0.1242	-9.0596	0.36	0.44	Jakes	Log-Logistic	-0.9383	0.2453
5	32	0.0472	-13.2576	0.48	0.78	Jakes	Log-Logistic	-0.7976	0.3371
6	40	0.0313	-15.0394	0.59	1	Jakes	Log-Logistic	-0.6182	0.2581
7	48	0.0129	-18.8940	0.48	0.94	Jakes	Log-Logistic	-0.6448	0.1544
8	56	0.0266	-16.8539	0.56	1.04	Jakes	Log-Logistic	-0.5082	0.1022
9	64	0.0140	-18.5330	0.62	1.36	Jakes	None	$\sigma_{Jakes}$ 0.4654	
10	72	0.0033	-24.8490	0.92	2.78	Jakes	None	0.4081	
11	80	0.0017	-27.7257	0.88	3.35	Jakes	None	0.4435	



TABLE 4: TDJ PARAMETERS OF  $h_{12}$  FOR HSR TUNNEL SCENARIO

Tap No.	Delay (ns)	Path Power		Fading Distribution		Doppler Spectrum			
		(lin.)	(dB)	Weibull		Shape	Fitting Model of $\sigma_{Jakes}$	$\mu_{LL}$	$\sigma_{LL}$
				$\beta_w$	$\Omega_{weib}$				
1	0	1	0	1.17	0.69	Jakes	Log-Logistic	0.0232	0.2397
2	8	0.2563	-5.9125	0.69	0.38	Jakes	Log-Logistic	-1.1955	0.2269
3	16	0.1654	-7.8156	0.52	0.35	Jakes	Log-Logistic	-1.2885	0.1851
4	24	0.1240	-9.0657	0.36	0.44	Jakes	Log-Logistic	-0.9382	0.2452
5	32	0.0464	-13.3303	0.48	0.78	Jakes	Log-Logistic	-0.7983	0.3357
6	40	0.0314	-15.0252	0.59	1.01	Jakes	Log-Logistic	-0.6083	0.2638
7	48	0.0123	-19.0947	0.50	0.94	Jakes	Log-Logistic	-0.6447	0.1537
8	56	0.0207	-16.8403	0.56	1.03	Jakes	Log-Logistic	-0.5084	0.1045
9	64	0.0134	-18.7221	0.60	1.27	Jakes	None	$\sigma_{Jakes}$ 0.4538	
10	72	0.0039	-24.1345	0.90	2.76	Jakes	None	0.4194	
11	80	0.0017	-27.8016	0.86	3.17	Jakes	None	0.4434	

TABLE 5: TDJ PARAMETERS OF  $h_{21}$  FOR HSR TUNNEL SCENARIO

Tap No.	Delay (ns)	Path Power		Fading Distribution		Doppler Spectrum			
		(lin.)	(dB)	Weibull		Shape	Fitting Model of $\sigma_{Jakes}$	$\mu_{LL}$	$\sigma_{LL}$
				$\beta_w$	$\Omega_{weib}$				
1	0	1	0	1.15	0.68	Jakes	Log-Logistic	0.0333	0.2369
2	8	0.2556	-5.9253	0.70	0.37	Jakes	Log-Logistic	-1.1919	0.2252
3	16	0.1440	-8.4177	0.53	0.36	Jakes	Log-Logistic	-1.2911	0.1878
4	24	0.1229	-9.1056	0.36	0.43	Jakes	Log-Logistic	-0.9459	0.2436
5	32	0.0497	-13.0347	0.49	0.81	Jakes	Log-Logistic	-0.7684	0.3655
6	40	0.0363	-14.3972	0.57	1.02	Jakes	Log-Logistic	-0.6153	0.2563
7	48	0.0132	-18.8071	0.49	0.89	Jakes	Log-Logistic	-0.6381	0.1596
8	56	0.0070	-21.5761	0.65	1.38	Jakes	Log-Logistic	-0.5238	0.1158
9	64	0.0149	-18.2809	0.59	1.35	Jakes	None	$\sigma_{Jakes}$ 0.4530	
10	72	0.0039	-24.0510	0.89	2.70	Jakes	None	0.4189	
11	80	0.0017	-27.7583	0.85	2.91	Jakes	None	0.4419	

TABLE 6: TDJ PARAMETERS OF  $h_{22}$  FOR HSR TUNNEL SCENARIO

Tap No.	Delay (ns)	Path Power		Fading Distribution		Doppler Spectrum			
		(lin.)	(dB)	Weibull		Shape	Fitting Model of $\sigma_{Jakes}$	$\mu_{LL}$	$\sigma_{LL}$
				$\beta_w$	$\Omega_{weib}$				
1	0	1	0	1.15	0.68	Jakes	Log-Logistic	0.0333	0.2368
2	8	0.2551	-5.9331	0.70	0.37	Jakes	Log-Logistic	-1.1915	0.2258
3	16	0.1472	-8.3209	0.53	0.35	Jakes	Log-Logistic	-1.2905	0.1863
4	24	0.1227	-9.1117	0.36	0.43	Jakes	Log-Logistic	-0.9459	0.2435
5	32	0.0498	-13.0290	0.49	0.81	Jakes	Log-Logistic	-0.7689	0.3655
6	40	0.0365	-14.3812	0.57	1.03	Jakes	Log-Logistic	-0.6076	0.2609
7	48	0.0129	-18.8986	0.49	0.86	Jakes	Log-Logistic	-0.6396	0.1604
8	56	0.0071	-21.4619	0.65	1.37	Jakes	Log-Logistic	-0.5239	0.1157
9	64	0.0149	-18.2646	0.59	1.35	Jakes	None	$\sigma_{Jakes}$ 0.4533	
10	72	0.0039	-24.0733	0.89	2.70	Jakes	None	0.4189	
11	80	0.0016	-27.8333	0.84	2.79	Jakes	None	0.4417	

particular case ( $\beta_w = 2$ ) of it.  $\beta_w$  accounts the fading severity, increasing the fading as  $\beta_w$  decreases.

Consequently, looking at the measured  $\beta_w$  parameter in Tables 3-6, we can see that the fading severity in this scenario is always much worse than Rayleigh, which gives an idea of how extreme and challenging the tunnel scenario is. Regarding the power distribution of the fading, we see that the relative power from the 3<sup>rd</sup>-4<sup>th</sup> tap increases monotonically. This can be explained in the reduction of MPCs and also on

its heterogeneity (in terms of followed paths, reflections, etc.) that arrive at the Rx as the tap-index increases, which means that the variance of the power of the MPCs is presumably higher.

The maximal speed for the train is 350 km/h, and the carrier frequency is 2.4 GHz which leads to a maximal Doppler shift of  $\pm 800$  Hz. Regarding the Doppler spectrum, all the taps in the models are Jakes' shaped and the distribution which fits better the Jakes'  $\sigma$  related to the model is log-

logistic (see tables 3-6 for more details and values of related parameters), and its probability density function (PDF) is:

$$pdf(\sigma(s, l); \mu_{LL}, \sigma_{LL}) = \frac{1}{\sigma_{LL}} \cdot \frac{1}{\sigma(s, l)} \cdot \frac{e^z}{(1 + e^z)^2} \quad (16)$$

$$z = \frac{\log(\sigma(s, l)) - \mu_{LL}}{\sigma_{LL}} \quad (17)$$

where  $\mu_{LL}$  is the mean of logarithmic value,  $\sigma_{LL}$  is the scale parameter of logarithmic value, and  $\sigma(s, l)$  is the fitting parameters of Jakes model for every taps. If the number of  $\sigma(s, l)$  of tap  $l$  is less than 15, one Jakes model is adopted to fit the Doppler shift of all the rays within this tap  $l$ . The obtained shifts for each tap of the TDL model and the statistical fit are both shown in Fig. 9.

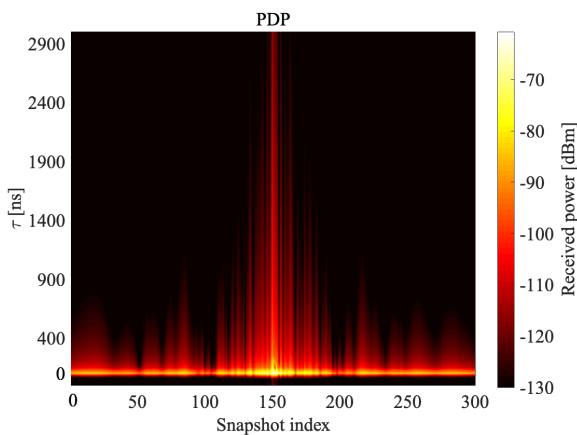

FIGURE 10: PDP for  $h_{11}$  in subway tunnel

## B. SUBWAY TUNNELS

The procedure for these simulations is the same as for HSR trains but this time we have a shorter tunnel, slower trains (110 km/h) and smaller trains as well (See Table 7-10 for all the simulation details). As in the HSR scenario we have a dominant line-of-sight (LOS) path in terms of power but here we have less resolvable MPCs (5 instead of 11 as we had in HSR). This is due to the size of the tunnel which tends to concentrate more power on the LOS component. This is depicted in Fig. 10 where it is even hard to appreciate the power for the other MPCs rather than the direct one.

The fading distribution is Weibull as in the HSR scenario, which makes sense because both tunnels share a common

propagation environment, with scatterers not uniformly distributed around the Rx.  $\beta_w$  figures are very similar in both cases, a little higher in subway which means less severe fading. In both cases, the fading is worse than Rayleigh ( $\beta_w < 2$ ). Regarding the Doppler spectrum, obviously, the maximum shift is lower (244 Hz) than in HSR because the train speed is lower (110 km/h). Regarding the distribution fitting, for the first two taps, the best fit is a Burr distribution. For the other three taps, there is no enough resolvable data points to do a proper fit (the number of  $\sigma(s, l)$  of tap  $l$  is less than 15). Burr distribution is depicted in (18). The Doppler spectrum associated to the five taps of this model is depicted in Fig. 11.

$$pdf(\sigma(s, l); \alpha, c, k) = \frac{\frac{k \cdot c}{\alpha} \left(\frac{\sigma(s, l)}{\alpha}\right)^{c-1}}{\left(1 + \left(\frac{\sigma(s, l)}{\alpha}\right)^c\right)^{k+1}}, \quad (18)$$

$$\alpha > 0, c > 0, k > 0$$

where  $\alpha$  is the scale parameter;  $c$  and  $k$  are both the shape factors. In Tables 7-10, we provide all the parameters related to this 2x2 MIMO TDL model.

## VI. CONCLUSIONS

In this paper we have presented a complete TDL-based channel model for railway tunnels considering two different scenarios: HSR and subway tunnels. The differences among them are subtle but important for real-world technical and engineering problems. The influence of the usual rolling stock that runs through these tunnels has been included in the model as well as other details in order to be more realistic.

The differences in the resolvable paths between HSR and subway tunnels are worth mentioning (11 and 5 for HSR and subway tunnels, respectively) as well as the dominance of the direct path in both cases but on a larger extent in the subway tunnel. The proposed TDL model can be embedded into emulators for an end-to-end emulation of RATs in tunnel environments. This will effectively help the design, development, and validation of FRMCS technologies.

TABLE 7: TDL PARAMETERS OF  $h_{11}$  FOR SUBWAY TUNNEL SCENARIO

Tap No.	Delay (ns)	Path Power		Fading Distribution		Doppler Spectrum				
		(lin.)	(dB)	Weibull		Shape	Fitting Model of $\sigma_{Jakes}$	$\alpha$	$c$	$k$
				$\beta_w$	$\Omega_{weib}$					
1	0	1	0	1.22	0.69	Jakes	Burr	0.6119	28.6175	0.2131
2	8	0.0377	-14.2312	0.68	0.44	Jakes	Burr	0.1568	39.1621	0.1061
3	32	0.0043	-23.6337	0.50	1.11	Jakes	None	$\sigma_{Jakes}$ 0.1329		
4	48	0.0070	-21.5570	0.57	1.25	Jakes	None	0.2275		
5	64	0.0013	-28.9994	0.96	4.02	Jakes	None	0.1991		

TABLE 8: TDJ PARAMETERS OF  $h_{12}$  FOR SUBWAY TUNNEL SCENARIO

Tap No.	Delay (ns)	Path Power		Fading Distribution		Doppler Spectrum				
		(lin.)	(dB)	Weibull		Shape	Fitting Model of $\sigma_{Jakes}$	$\alpha$	$c$	$k$
				$\beta_\omega$	$\Omega_{weib}$					
1	0	1	0	1.22	0.69	Jakes	Burr	0.6121	28.5526	0.2134
2	8	0.0378	-14.2202	0.68	0.44	Jakes	Burr	0.1568	40.4683	0.1025
3	32	0.0043	-23.6271	0.50	1.11	Jakes	None	$\sigma_{Jakes}$		
4	48	0.0070	-21.5352	0.57	1.25	Jakes	None	0.1325		
5	64	0.0013	-28.9919	0.96	4.02	Jakes	None	0.2275		
								0.1991		

TABLE 9: TDJ PARAMETERS OF  $h_{21}$  FOR SUBWAY TUNNEL SCENARIO

Tap No.	Delay (ns)	Path Power		Fading Distribution		Doppler Spectrum				
		(lin.)	(dB)	Weibull		Shape	Fitting Model of $\sigma_{Jakes}$	$\alpha$	$c$	$k$
				$\beta_\omega$	$\Omega_{weib}$					
1	0	1	0	1.19	0.69	Jakes	Burr	0.6179	19.7439	0.3316
2	8	0.0373	-14.2777	0.67	0.47	Jakes	Burr	0.1575	40.0865	0.1032
3	32	0.0045	-23.5007	0.53	1.17	Jakes	None	$\sigma_{Jakes}$		
4	48	0.0075	-21.2624	0.57	1.26	Jakes	None	0.1436		
5	64	0.0013	-28.7612	0.96	4.02	Jakes	None	0.2165		
								0.1991		

TABLE 10: TDJ PARAMETERS OF  $h_{22}$  FOR SUBWAY TUNNEL SCENARIO

Tap No.	Delay (ns)	Path Power		Fading Distribution		Doppler Spectrum				
		(lin.)	(dB)	Weibull		Shape	Fitting Model of $\sigma_{Jakes}$	$\alpha$	$c$	$k$
				$\beta_\omega$	$\Omega_{weib}$					
1	0	1	0	1.19	0.69	Jakes	Burr	0.6182	19.6848	0.3323
2	8	0.0318	-14.9759	0.67	0.49	Jakes	Burr	0.1575	40.4733	0.1021
3	32	0.0045	-23.4983	0.53	1.17	Jakes	None	$\sigma_{Jakes}$		
4	48	0.0075	-21.2391	0.57	1.27	Jakes	None	0.1441		
5	64	0.0013	-28.7540	0.96	4.02	Jakes	None	0.2171		
								0.1991		

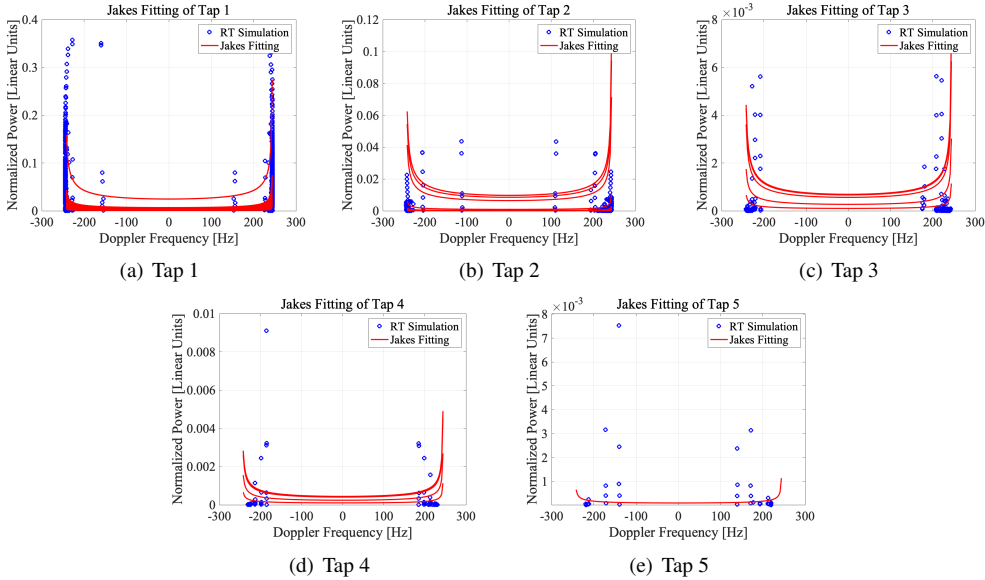
FIGURE 11: The Doppler shift and its Jakes fitting model of the  $h_{11}$  channel for subway scenario

## REFERENCES

- [1] J. Moreno, J. M. Riera, L. d. Haro, and C. Rodriguez, "A survey on future railway radio communications services: challenges and opportunities," IEEE Communications Magazine, vol. 53, no. 10, pp. 62–68, 2015.
- [2] Y. Liu, C. X. Wang, C. Lopez, and X. Ge, "3d non-stationary wide-band circular tunnel channel models for high-speed train wireless communica-

- tion systems,” *Sci. China Inf. Sci.*, vol. 60, no. 8, 2017.
- [3] “Emulradio4rail project,” IFSTTAR, Tech. Rep., [Online]. Available: <http://www.emulradio4rail.eu>.
- [4] Y. Liu, C. Wang, C. F. Lopez, G. Goussetis, Y. Yang, and G. K. Karagiannidis, “3d non-stationary wideband tunnel channel models for 5g high-speed train wireless communications,” *IEEE Transactions on Intelligent Transportation Systems*, vol. 21, no. 1, pp. 259–272, 2020.
- [5] Y. Liu, C. Wang, and J. Huang, “Recent developments and future challenges in channel measurements and models for 5g and beyond high-speed train communication systems,” *IEEE Communications Magazine*, vol. 57, no. 9, pp. 50–56, 2019.
- [6] Y. Liu, C. Wang, J. Huang, J. Sun, and W. Zhang, “Novel 3-d nonstationary mmwave massive mimo channel models for 5g high-speed train wireless communications,” *IEEE Transactions on Vehicular Technology*, vol. 68, no. 3, pp. 2077–2086, 2019.
- [7] S. Wu, C. Wang, e. M. Aggoune, M. M. Alwakeel, and X. You, “A general 3-d non-stationary 5g wireless channel model,” *IEEE Transactions on Communications*, vol. 66, no. 7, pp. 3065–3078, 2018.
- [8] K. Guan, Z. Zhong, and B. Ai, “Assessment of lte-r using high speed railway channel model,” *Proc. 3rd Int. Conf. Commun. Mobile Comput. (CMC’11)*, pp. 461–464, 2011.
- [9] “Future railway mobile communication system (frmcs),” UIC, Tech. Rep., [Online]. Available: <https://uic.org/rail-system/frmcs/>.
- [10] B. Ai, X. Cheng, T. Kürner, Z. Zhong, K. Guan, R. He, L. Xiong, D. W. Matolak, D. G. Michelson, and C. Briso-Rodríguez, “Challenges toward wireless communications for high-speed railway,” *IEEE Transactions on Intelligent Transportation Systems*, vol. 15, no. 5, pp. 2143–2158, 2014.
- [11] A. F. Molisch, *Wireless Communications*, 2nd edition. IEEE-Wiley, 2011.
- [12] J. García-Loygorri, “Emulation of end-to-end communications systems in railway scenarios: physical layer results,” in in 2020 14th European Conference on Antennas and Propagation (EuCAP), 2020.
- [13] L. Zhang, C. Briso, J. R. O. Fernandez, J. I. Alonso, C. Rodríguez, J. M. García-Loygorri, and K. Guan, “Delay spread and electromagnetic reverberation in subway tunnels and stations,” *IEEE Antennas and Wireless Propagation Letters*, vol. 15, pp. 585–588, 2016.
- [14] X. Cai, X. Yin, X. Cheng, and A. Pérez Yuste, “An empirical random-cluster model for subway channels based on passive measurements in umts,” *IEEE Transactions on Communications*, vol. 64, no. 8, pp. 3563–3575, 2016.
- [15] J. Yu, W. Chen, F. Li, C. Li, K. Yang, Y. Liu, and F. Chang, “Channel measurement and modeling of the small-scale fading characteristics for urban inland river environment,” *IEEE Transactions on Wireless Communications*, vol. 19, no. 5, pp. 3376–3389, 2020.
- [16] C. Briso-Rodríguez, J. M. Cruz, and J. I. Alonso, “Measurements and modeling of distributed antenna systems in railway tunnels,” *IEEE Transactions on Vehicular Technology*, vol. 56, no. 5, pp. 2870–2879, 2007.
- [17] K. Guan, Z. Zhong, J. I. Alonso, and C. Briso-Rodríguez, “Measurement of distributed antenna systems at 2.4 ghz in a realistic subway tunnel environment,” *IEEE Transactions on Vehicular Technology*, vol. 61, no. 2, pp. 834–837, 2012.
- [18] J. H. Zhang, P. Tang, L. Tian, Z. X. Hu, T. Wang, and H. M. Wang, “6-100 ghz research progress and challenges for fifth generation (5G) and future wireless communication from channel perspective,” *Sci. China Inf. Sci.*, vol. 60, no. 8, pp. 1–16, 2017.
- [19] M. Shafi, J. Zhang, H. Tataria, A. F. Molisch, S. Sun, T. S. Rappaport, F. Tufvesson, S. Wu, and K. Kitao, “Microwave vs. millimeter-wave propagation channels: Key differences and impact on 5G cellular systems,” *IEEE Communications Magazine*, vol. 56, no. 12, pp. 14–20, 2018.
- [20] B. Ai, K. Guan, Z. Zhong, C. F. López, L. Zhang, C. Briso-Rodríguez, and R. He, “Measurement and analysis of extra propagation loss of tunnel curve,” *IEEE Transactions on Vehicular Technology*, vol. 65, no. 4, pp. 1847–1858, 2016.
- [21] C. X. Wang, A. Ghazal, B. Ai, Y. Liu, and P. Fan, “Channel measurements and models for high-speed train communication systems: A survey,” *IEEE Communications Surveys Tutorials*, vol. 18, no. 2, pp. 974–987, 2016.
- [22] B. Ai, R. S. He, Z. Zhong, K. Guan, B. H. Chen, P. Y. Liu, and Y. X. Li, “Radio wave propagation scene partitioning for high-speed rails,” *Int. J. Antennas Propag.*, vol. 2012, no. 815232, 2012.
- [23] K. Guan, G. Li, T. Kürner, A. F. Molisch, B. Peng, R. He, B. Hui, J. Kim, and Z. Zhong, “On millimeter wave and thz mobile radio channel for smart rail mobility,” *IEEE Transactions on Vehicular Technology*, vol. 66, no. 7, pp. 5658–5674, 2017.
- [24] D. He, B. Ai, K. Guan, Z. Zhong, B. Hui, J. Kim, H. Chung, and I. Kim, “Channel measurement, simulation, and analysis for high-speed railway communications in 5G millimeter-wave band,” *IEEE Transactions on Intelligent Transportation Systems*, vol. 19, no. 10, pp. 3144–3158, 2018.
- [25] H. Wei, Z. Zhong, K. Guan, and B. Ai, “Path loss models in viaduct and plain scenarios of the high-speed railway,” *Proc. CHINACOM*, pp. 1–5, 2010.
- [26] K. Guan, Z. Zhong, B. Ai, and T. Kürner, “Semi-deterministic path-loss modeling for viaduct and cutting scenarios of high-speed railway,” *IEEE Antennas and Wireless Propagation Letters*, vol. 12, pp. 789–792, 2013.
- [27] R. He, Z. Zhong, B. Ai, L. Xiong, and H. Wei, “A novel path loss model for high-speed railway viaduct scenarios,” in 2011 7th International Conference on Wireless Communications, Networking and Mobile Computing, 2011, pp. 1–4.
- [28] F. Luan, Y. Zhang, L. Xiao, C. Zhou, and S. Zhou, “Fading characteristics of wireless channel on high-speed railway in hilly terrain scenario,” in *Int. J. Antennas Propag.*, 2013.
- [29] Y. Zhang, Z. He, W. Zhang, L. Xiao, and S. Zhou, “Measurement-based delay and doppler characterizations for high-speed railway hilly scenario,” in *Int. J. Antennas Propag.*, 2014.
- [30] Y. Liu, A. Ghazal, C. X. Wang, X. Ge, Y. Yang, and Y. Zhang, “Channel measurements and models for high-speed train wireless communication systems in tunnel scenarios: A survey,” *Sci. China Inf. Sci.*, vol. 60, no. 8, 2017.
- [31] M. Berbineau, “Emulation of various radio access technologies for zero-on-site testing in the railway domain – the emulradio4rail platforms,” in *TRA 2020, Helsinki (Finland)*, 2020.
- [32] B. Allen, “Defining an adaptable communications system for all railways,” in in 13th International Workshop on Communication Technologies for Vehicles, Madrid (Spain), 2018.
- [33] D. He, B. Ai, K. Guan, L. Wang, Z. Zhong, and T. Kürner, “The design and applications of high-performance ray-tracing simulation platform for 5G and beyond wireless communications: A tutorial,” *IEEE Communications Surveys Tutorials*, vol. 21, no. 1, pp. 10–27, 2019.
- [34] C. Wang, J. Wang, H. Wang, X. Gao, X. You, and Y. Hao, “6g wireless channel measurements and models: Trends and challenges,” *IEEE Veh. Technol. Mag.*, accepted for publication.
- [35] C. Wang, J. Bian, J. Sun, W. Zhang, and M. Zhang, “A survey of 5g channel measurements and models,” *IEEE Communications Surveys & Tutorials*, vol. 20, no. 4, pp. 3142–3168, 2018.
- [36] K. Guan, B. Peng, D. He, J. M. Eckhardt, S. Rey, B. Ai, Z. Zhong, and T. Kürner, “Channel characterization for intra-wagon communication at 60 and 300 ghz bands,” *IEEE Transactions on Vehicular Technology*, vol. 68, no. 6, pp. 5193–5207, 2019.
- [37] K. Guan, G. Li, T. Kürner, A. F. Molisch, B. Peng, R. He, B. Hui, J. Kim, and Z. Zhong, “On millimeter wave and thz mobile radio channel for smart rail mobility,” *IEEE Transactions on Vehicular Technology*, vol. 66, no. 7, pp. 5658–5674, 2017.
- [38] K. Guan, B. Ai, B. Peng, D. He, G. Li, J. Yang, Z. Zhong, and T. Kürner, “Towards realistic high-speed train channels at 5G millimeter-wave band—part I: Paradigm, significance analysis, and scenario reconstruction,” *IEEE Transactions on Vehicular Technology*, vol. 67, no. 10, pp. 9112–9128, 2018.
- [39] ———, “Towards realistic high-speed train channels at 5G millimeter-wave band—part II: Case study for paradigm implementation,” *IEEE Transactions on Vehicular Technology*, vol. 67, no. 10, pp. 9129–9144, 2018.
- [40] D. He, B. Ai, K. Guan, J. M. García-Loygorri, L. Tian, Z. Zhong, and A. Hrovat, “Influence of typical railway objects in a mmwave propagation channel,” *IEEE Transactions on Vehicular Technology*, vol. 67, no. 4, pp. 2880–2892, 2018.
- [41] M. Patzold, *Mobile fading channels - modelling, analysis and simulation*. Wiley, 2002.
- [42] J. Yang, B. Ai, S. Salous, K. Guan, D. He, G. Shi, and Z. Zhong, “An efficient mimo channel model for lte-r network in high-speed train environment,” *IEEE Transactions on Vehicular Technology*, vol. 68, no. 4, pp. 3189–3200, 2019.
- [43] N. C. Sagias and G. K. Karagiannidis, “Gaussian class multivariate weibull distributions: theory and applications in fading channels,” *IEEE Transactions on Information Theory*, vol. 51, no. 10, pp. 3608–3619, 2005.



HAO QIU received B.E. degree from Beijing Jiaotong University in 2019. He is a Master degree candidate in State Key Laboratory of Rail Traffic Control and Safety & School of Electronic and Information Engineering, Beijing Jiaotong University. His current research interests are in the field of measurement and modeling of wireless propagation channels, high-speed railway communications, vehicle-to-x channel characterization, and indoor channel characterization for high-speed short-range systems including future terahertz communication systems.



DANPING HE (M'16) received B.E. degree from Huazhong University of Science and Technology in 2008, M.Sc. degree from the Université Catholique de Louvain (UCL) and Politecnico di Torino (PdT) in 2010, and Ph.D. degree from Universidad Politécnica de Madrid in 2014. In 2012, she was a visiting scholar in Institut national de recherche en informatique et en automatique, France. She worked in Huawei Technologies from 2014 to 2015 as a research engineer. From 2016 to 2018, she conducted postdoctoral research in Beijing Jiaotong University, and she is now Associate Professor in Beijing Jiaotong University.

She has authored/co-authored more than 40 papers, 3 patents and 1 IEEE standard. Her papers received 5 Best Paper Awards and she received 2019 Applied Computational Electromagnetics Society (ACES)-China Young Scientist Award. Her current research interests include radio propagation and channel modeling, ray-tracing technologies and wireless communication algorithm design.



JUAN MORENO GARCIA-LOYGORRI Dr. Juan Moreno works as a rolling stock engineer in the Engineering and Research Department of Madrid Metro, where he has led many projects on railway communications and is now focused on research activities. He is also a part-time professor and researcher in the Universidad Politécnica de Madrid. He has been working in railways since 2007, first on high-speed and then in subways. He has participated in many railway-related research

projects like Roll2Rail, EmulRadio4Rail, Run2Rail and Tecrail, and has authored more than 50 papers on railway communications. His research interests are channel measurement & modelling, railway communications systems, condition-based maintenance for railways and software-defined radio.



KE GUAN (S'10-M'13-SM'19) received B.E. degree and Ph.D. degree from Beijing Jiaotong University in 2006 and 2014, respectively. He is a Professor in State Key Laboratory of Rail Traffic Control and Safety & School of Electronic and Information Engineering, Beijing Jiaotong University. In 2015, he has been awarded a Humboldt Research Fellowship for Postdoctoral Researchers. In 2009, he was a Visiting Scholar with Universidad Politécnica de Madrid, Spain. From 2011 to 2013,

he was a Research Scholar with the Institut für Nachrichtentechnik (IfN) at Technische Universität Braunschweig, Germany. From September 2013 to January 2014, he was invited to conduct joint research in Universidad Politécnica de Madrid, Spain. He has authored/coauthored two books and one book chapter, more than 200 journal and conference papers, and four patents. His current research interests include measurement and modeling of wireless propagation channels, high-speed railway communications, vehicle-to-x channel characterization, and indoor channel characterization for high-speed short-range systems including future terahertz communication systems.

Dr. Guan is the pole leader of EURNEX (European Railway Research Network of Excellence). He was the recipient of a 2014 International Union of Radio Science (URSI) Young Scientist Award. His papers received eight Best Paper Awards, including IEEE vehicular technology society 2019 Neal Shepherd memorial best propagation paper award. He is an Editor of IEEE ACCESS, the IET Microwave, Antenna and Propagation, Physical Communication, and a Guest Editor of the IEEE Transactions on Vehicular Technology and IEEE Communication Magazine. He serves as a Publicity Chair in PIMRC 2016, the Publicity Co-Chair in ITST 2018, the Track Co-Chair in EuCNC, the Session Convener of EuCAP 2015-2019, and a TPC Member for many IEEE conferences, such as Globecom, ICC and VTC. He has been a delegate in 3GPP and a member of the IC1004 and CA15104 initiatives.



ZIHENG XU is currently an undergraduate and will start the Master program in 2020 in Lightwave Laboratory & School of Electronic and Information Engineering, Beijing Jiaotong University. He used to take part in the program of Modeling of Millimeter Wave Channel in Madrid Metro then published an IEEE conference paper as second author. His future research direction is in the field of electromagnetic field and microwave technology.



BO AI (M'00-SM'10) received his Master and Ph.D. degree from Xidian University in 2002 and 2004 in China, respectively. He graduated in 2007 with great honors of Excellent Postdoctoral Research Fellow in Tsinghua University. He is now working in Beijing Jiaotong University as a professor and advisor of Ph.D. candidates. He is a deputy director of State Key Lab of Rail Traffic Control and Safety. He is an associate editor for IEEE Trans. on Consumer Electronics and an editorial committee member of journal of Wireless Personal Communications.

He has authored/co-authored 6 books, 140 scientific research papers and 26 invention patents in his research area till now. His current interests are the research and applications OFDM techniques, HPA linearization techniques, radio propagation and channel modeling, GSM for railway systems, and LTE for railway systems. He is an IET Fellow and an IEEE Senior member.



MARION BERBINEAU received the Engineer degree from Polytech'Lille former EUDIL in Informatics, Electronics, Automatics, and the PhD degree in Electronics from the University of Lille, France, in 1986 and 1989 respectively. Dr BERBINEAU is Research Director at Université Gustave Eiffel (previously Ifsttar and Inrets) since 2000. She was director of Leost laboratory from 2000 to 2013, then deputy director of COSYS department from 2013 to 2017. In addition to

research activities and supervision of PhD students, she coordinates Railway research at Université Gustave Eiffel. She is pole leader of the Intelligent Mobility pole of Eurnex (European Railway Research Network of Excellence). Her current interests are wireless communications for connected and automatic vehicles (Trains and Cars) (radio propagation, channel characterization and modelling, MCM, MIMO, ITS-G5, GSM-R, LTE, 5G NR). She has already participated to a lot of European and national research projects since 1990, She is currently the project leader of Emulradio4rail project in the framework of Shift2rail IP2 and involved in several other projects (X2RAIL3, X2RAIL4, X2RAIL5). She is IEEE member and on the reserve list of the Scientific council of Shift2rail program.

...