



**HAL**  
open science

## A generalization of environmental productivity analysis

Arnaud Abad, Paola Ravelojaona

► **To cite this version:**

Arnaud Abad, Paola Ravelojaona. A generalization of environmental productivity analysis. *Journal of Productivity Analysis*, 2022, 57 (1), pp.61-78. 10.1007/s11123-021-00620-1 . hal-03592375v2

**HAL Id: hal-03592375**

**<https://hal.science/hal-03592375v2>**

Submitted on 11 Apr 2023

**HAL** is a multi-disciplinary open access archive for the deposit and dissemination of scientific research documents, whether they are published or not. The documents may come from teaching and research institutions in France or abroad, or from public or private research centers.

L'archive ouverte pluridisciplinaire **HAL**, est destinée au dépôt et à la diffusion de documents scientifiques de niveau recherche, publiés ou non, émanant des établissements d'enseignement et de recherche français ou étrangers, des laboratoires publics ou privés.



**HAL**  
open science

# A Generalization of Environmental Productivity Analysis

Arnaud Abad, Paola Ravelojaona

► **To cite this version:**

Arnaud Abad, Paola Ravelojaona. A Generalization of Environmental Productivity Analysis. 2020.  
hal-02964799

**HAL Id: hal-02964799**

**<https://hal.inrae.fr/hal-02964799>**

Preprint submitted on 12 Oct 2020

**HAL** is a multi-disciplinary open access archive for the deposit and dissemination of scientific research documents, whether they are published or not. The documents may come from teaching and research institutions in France or abroad, or from public or private research centers.

L'archive ouverte pluridisciplinaire **HAL**, est destinée au dépôt et à la diffusion de documents scientifiques de niveau recherche, publiés ou non, émanant des établissements d'enseignement et de recherche français ou étrangers, des laboratoires publics ou privés.

# A Generalization of Environmental Productivity Analysis

A. Abad\*<sup>†</sup> and P. Ravelojaona<sup>†</sup>

## Abstract

This paper aims to analyse environmental Total Factor Productivity (TFP) change. Indeed, innovative environmental TFP measures are introduced through convex and non convex environmental production processes. Hence, the impacts of input and output quality change on environmental productivity variation are underscored. In addition, general decomposition of the new ratio- and difference-based environmental TFP measures is proposed.

**Keywords:** Environmental efficiency, Non Convexity, Pollution-generating Technology, Total Factor Productivity Indices

**JEL:** C61, D24, Q50

---

\*INRAE, BETA, Nancy, France.

<sup>†</sup>University of Perpignan, 52 Avenue Paul Alduy, F-66860 Perpignan Cedex, France.

# 1 Introduction

Solow (1957) lays out the foundations of current Total Factor Productivity (TFP) analysis. TFP advances arise if the change in outputs is greater than inputs variation. Traditionally, Solow's residual (state of the technology) appears as the driver of TFP change.

In the context of multiple input-output, Caves et al. (1982) define Malmquist productivity indices using multiplicative distance functions as general representation of the production technology. In the same vein, Bjurek (1996) introduces an alternative form of the Malmquist ratio-based productivity measure. The Hicks-Moorsten productivity index (Bjurek, 1996) is defined as the ratio of Malmquist output quantity index and Malmquist input quantity index. Chambers (2002) introduces the difference-based Luenberger productivity indicator. This productivity measure is defined as difference-based indicator of directional distance functions (Chambers et al., 1996). Thereafter, Briec and Kerstens (2004) present the Luenberger-Hicks-Moorsteen productivity indicator. This productivity measure is defined as the difference between Luenberger output quantity indicator and Luenberger input quantity indicator. Most of theoretical and empirical research on TFP analysis employed previously mentioned ratio- and difference-based productivity measures (Färe et al., 1994; Bjurek et al., 1998; Boussemart et al., 2003; Nakano and Managi, 2008; Managi, 2010; Kerstens and Van de Woestyne, 2014; Ang and Kerstens, 2017; Diewert and Fox, 2017).

Since Pittman (1983), a large number of environmental productivity change analysis has been proposed in the literature (Tyteca, 1996; Boyd and McCelland, 1999; Hailu and Veeman, 2000; Aiken and Pasurka, 2003; Hoang and Coelli, 2011). Prominent feature of this literature is the axiomatic definition of the production technology. Traditional trade-off of input and output (free disposability) vanishes when pollution-generating activities arise. Indeed, polluting and no polluting factors lead to the production of desirable and undesirable products in pollution-generating technologies (Färe et al., 1989; Lauwers and Van Huylenbroeck, 2003; Coelli et al., 2007; Lauwers, 2009; Førsund, 2009, 2016; Murty et al., 2012; Rødseth, 2017). In this paper, environmental productivity measures are defined through the new  $B$ -disposal scheme (Abad and Briec, 2019); the  $B$ -disposal approach is an axiomatic representation of pollution-generating technology in input and output dimensions. Hence, environmental TFP change is analysed in a general framework (convex and non convex) with environmental disaggregation of input and output (polluting and no polluting components).

Malmquist-Luenberger (Chung et al., 1997) and environmental Luenberger (Azad and Ancev, 2014; Picazo-Tadeo et al., 2014) environmental productivity measures are widely applied in the literature (Kumar, 2006; Oh and Heshmati, 2010; Färe et al., 2012;

Shen et al., 2017; Miao et al., 2019). In this paper, we define environmental additive and multiplicative complete TFP measures. Indeed, environmental Hicks-Moorsten and Luenberger-Hicks-Moorsten productivity measures (Abad, 2015) are introduced through a disaggregation of input and output vectors. Hence, the impacts of input and output quality change on environmental productivity variation are underscored. In addition, these environmental productivity measures are defined for convex and non convex environmental production processes. Therefore, the convexity property is not required to analyse environmental productivity variation. These results are of particular interest for theoretical (Dasgupta and Mäler, 2003; Tschirhart, 2012; Chavas and Briec, 2012, 2018) and empirical (De Borger and Kerstens, 1996; Grifell-Tatjé and Kerstens, 2008) studies.

Additively and multiplicatively complete TFP measures can be decomposed using either the input or the output direction. Recently, Diewert and Fox (2017) and Ang and Kerstens (2017) successfully decomposed the Hicks-Moorsteen and the Luenberger-Hicks-Moorsteen complete TFP measures, respectively. In this paper general decomposition of the new ratio- and difference-based environmental disaggregated TFP measures is proposed. The identification of the origins of environmental productivity variation is a major concern for decision makers and/or analysts. Indeed, these components are the prominent drivers of environmental TFP change and can influence economic decisions.

The remainder of this paper is divided in four sections. Technology properties and environmental distance functions are defined in the next section. Section 3 introduces environmental disaggregated Hicks-Moorsteen and Luenberger-Hicks-Moorsteen productivity measures. Decomposition of these TFP index and indicator is proposed in the Section 4. Finally, Section 5 discusses and concludes.

## 2 Technology and efficiency measures

Assume that  $n^p$  inputs of the technology induce detrimental products (pollution). The remaining inputs ( $n - n^p = n^{np}$ ) of the production process are non emission causing. Hence, the input vector is defined as  $x_t \in \mathbb{R}_+^n$ , where  $n = n^{np} + n^p$ . In addition, we postulate that the output vector is partitioned in polluting and no polluting components. Indeed, the products of the technology are separated in  $m^{np}$  desirable outputs and  $m^p$  pollution-generating outputs. It follows that  $y_t \in \mathbb{R}_+^m$  where,  $m = m^{np} + m^p$ .

### 2.1 Technology: definition and properties

In this section, we present definitions of the production process and the axioms associated to this production technology. This will be the basis of the remainder sections.

The environmental production technology is defined as,

$$T_t = \{(x_t^{np}, x_t^p, y_t^{np}, y_t^p) \in \mathbb{R}_+^{n+m} : (x_t^{np}, x_t^p) \text{ can produce } (y_t^{np}, y_t^p)\}. \quad (2.1)$$

Usually, the production technology (2.1) is characterized by the output  $P_t : \mathbb{R}_+^n \mapsto 2^{\mathbb{R}_+^m}$  or the input,  $L_t : \mathbb{R}_+^m \mapsto 2^{\mathbb{R}_+^n}$ , correspondences such that:

$$P_t(x_t^{np}, x_t^p) = \{(y_t^{np}, y_t^p) \in \mathbb{R}_+^m : (x_t^{np}, x_t^p, y_t^{np}, y_t^p) \in T_t\}, \quad (2.2)$$

and

$$L_t(y_t^{np}, y_t^p) = \{(x_t^{np}, x_t^p) \in \mathbb{R}_+^n : (x_t^{np}, x_t^p, y_t^{np}, y_t^p) \in T_t\}. \quad (2.3)$$

Hence,

$$(x_t^{np}, x_t^p) \in L_t(y_t^{np}, y_t^p) \Leftrightarrow (x_t^{np}, x_t^p, y_t^{np}, y_t^p) \in T_t \Leftrightarrow (y_t^{np}, y_t^p) \in P_t(x_t^{np}, x_t^p). \quad (2.4)$$

Let  $B \subset [n] \times [m]$  be the subset indexing polluting inputs and outputs of the technology. We assume that the production technology satisfies the following regularity properties (Färe et al., 1985):

*T1:*  $(0, 0) \in T_t$ ,  $(0, y) \in T_t \Rightarrow y = 0$ .

*T2:*  $T_t(y_t) = \{(u_t, v_t) \in T_t : v_t \leq y_t\}$  is bounded for all  $y_t \in \mathbb{R}_+^m$ .

*T3:*  $T_t$  is closed.

*T4:*  $T_t$  is convex.

In addition to the properties *T1-T4*, we postulate that the production technology satisfies the generalized  $B$ -disposal assumption (Abad and Briec, 2019)

*T5:* For any  $(x_t^\emptyset, y_t^\emptyset)$ ,  $(x_t^B, y_t^B) \in T_t$ ,  $(-x_t, y_t) \leq^\emptyset (-x_t^\emptyset, y_t^\emptyset)$  and  $(-x_t, y_t) \leq^B (-x_t^B, y_t^B)$  implies that  $(x_t, y_t) \in T_t$ .

Axioms *T1 – T3* and *T5* define general pollution-generating production process. These assumptions do not impose any convexity property. Figures 1 and 2 illustrate this PgT through input and output correspondences.

**FIGURES 1-2 ABOUT HERE**

## 2.2 Environmental disaggregated distance functions

Following Abad (2018), we propose a general formulation of multiplicative and additive distance measures. Indeed, we refer to a "generalized" shape of distance functions since we can retrieve the usual and widely used efficiency measures in the literature.

### 2.2.1 Multiplicative scheme

In this section, we introduce an environmental generalized shape of multiplicative distance function by disaggregating input and output vectors. Indeed, we can derive the Shephard (1970), the Debreu (1951)-Farrell (1957) and the hyperbolic (Färe et al., 1985) efficiency measures from this generalised formulation. The next result defines environmental disaggregated multiplicative efficiency measure.

**Definition 2.1** *Let  $T_t$  be a production technology that satisfies properties T1 – T3 and T5. For any  $(x_t, y_t) \in \mathbb{R}_+^{n+m}$ , where  $x_t = (x_t^p, x_t^{np}) \in \mathbb{R}_+^n$  et  $y_t = (y_t^p, y_t^{np}) \in \mathbb{R}_+^m$ , the environmental disaggregated multiplicative distance function,  $\Psi : \mathbb{R}_+^{n+m} \rightarrow \mathbb{R}^+ \cup \infty$ , is defined as follows:*

$$\Psi_t(x_t, y_t) = \begin{cases} \inf_{\theta} \left\{ \theta > 0 : (\theta^{\alpha^p} x_t^p, \theta^{\alpha^{np}} x_t^{np}, \theta^{\lambda^p} y_t^p, \theta^{\lambda^{np}} y_t^{np}) \in T_t \right\} \\ \infty & \text{if } (\theta^{\alpha^p} x_t^p, \theta^{\alpha^{np}} x_t^{np}, \theta^{\lambda^p} y_t^p, \theta^{\lambda^{np}} y_t^{np}) \in T_t, \theta > 0 \\ \infty & \text{else} \end{cases} \quad (2.5)$$

with  $\alpha^p = \alpha^{np} = \{0, 1\}$ ,  $\lambda^p = \{0, 1\}$  and  $\lambda^{np} = \{-1, 0\}$ .

With regards to the definition above, the following proposition states the properties of the multiplicative distance function.

**Proposition 2.2** *For any  $\alpha^p = \alpha^{np} = \{0, 1\}$ ,  $\lambda^p = \{0, 1\}$ ,  $\lambda^{np} = \{-1, 0\}$  and any  $(x_t, y_t) \in \mathbb{R}_+^{n+m}$  with  $x_t = (x_t^p, x_t^{np}) \in \mathbb{R}_+^n$  and  $y_t = (y_t^p, y_t^{np}) \in \mathbb{R}_+^m$ , the multiplicative distance function  $\Psi_t(x_t, y_t)$  (a.1) fully characterises the production set, (a.2) is equal to 1 if the production unit belongs to the efficient frontier, (a.3) is homogeneous of degree 0 under a constant returns-to-scale, (a.4) is homogeneous of degree (-1) in both polluting and no polluting inputs and outputs, (a.5) is invariant with respect to the unit of measurement and (a.6) is non-decreasing in no polluting outputs and non-increasing in polluting outputs, in polluting and no polluting inputs under a B-disposability assumption.*

See Appendix 1 for the proof.

From the definition above, it is obvious that according to the parameters  $\alpha$  and  $\lambda$ , we can propose input and/or output oriented environmental disaggregated multiplicative distance function in either no polluting or polluting directions.

**Proposition 2.3** For any  $(x_t, y_t) \in \mathbb{R}_+^{n+m}$ , such that  $x_t = (x_t^p, x_t^{np}) \in \mathbb{R}_+^n$  and  $y_t = (y_t^{np}, y_t^p) \in \mathbb{R}_+^m$ , we have:

- i.  $\Psi_t(x_t, y_t) \equiv \Psi_t^{o^{np}}(x_t, y_t)$ , if  $\alpha^p = \alpha^{np} = \lambda^p = 0$ , and  $\lambda^{np} = -1$ .
- ii.  $\Psi_t(x_t, y_t) \equiv \Psi_t^{o^p}(x_t, y_t)$ , if  $\alpha^p = \alpha^{np} = \lambda^{np} = 0$ , and  $\lambda^p = 1$ .
- iii.  $\Psi_t(x_t, y_t) \equiv \Psi_t^{i^{np}}(x_t, y_t)$ , if  $\alpha^{np} = 1$  and  $\alpha^p = \lambda^p = \lambda^{np} = 0$ .
- iv.  $\Psi_t(x_t, y_t) \equiv \Psi_t^{i^p}(x_t, y_t)$ , if  $\alpha^p = 1$  and  $\alpha^{np} = \lambda^p = \lambda^{np} = 0$ .

Remark that these distance functions inherit the basic structure of the Shephard efficiency measures. Figures 4 and 3 illustrate input and output sub-vectors no polluting and polluting multiplicative efficiency measures.

## FIGURES 3-4 ABOUT HERE

The mathematical programs of convex and non convex cases, through the Data Envelopment Analysis (DEA) framework, are presented in Appendix 2.

### 2.2.2 Additive scheme

This section allows to present an environmental generalised shape of additive efficiency measures through the disaggregation of inputs and outputs. In this sense, we can retrieve the usual and widely used additive distance functions as the directional distance function (Chambers et al., 1996) and the Farrell proportional distance function (Briec, 1997). The following definition introduces environmental disaggregated additive efficiency measure.

**Definition 2.4** Let  $T_t$  be a production technology that satisfies properties T1 – T3 and T5. For any  $(x_t, y_t) \in \mathbb{R}_+^{n+m}$ , where  $x_t = (x_t^p, x_t^{np}) \in \mathbb{R}_+^n$  et  $y_t = (y_t^p, y_t^{np}) \in \mathbb{R}_+^m$ , the



environmental disaggregated additive distance function,  $\Xi^{\gamma, \sigma} : \mathbb{R}_+^{n+m} \times [0, 1]^n \times [0, 1]^{m^{np}} \times [-1, 0]^{m^p} \rightarrow \mathbb{R} \cup -\infty$ , is defined below:

$$\Xi_t^{\gamma, \sigma}(x_t, y_t) = \begin{cases} \sup_{\beta} \left\{ \beta \in \mathbb{R} : \left( (1 - \beta \odot \gamma^{np})x_t^{np}, (1 - \beta \odot \gamma^p)x_t^p, \right. \right. \\ \left. \left. (1 + \beta \odot \sigma^{np})y_t^{np}, (1 + \beta \odot \sigma^p)y_t^p \right) \in T_t \right\} \\ \text{if } \left( (1 - \beta \odot \gamma^{np})x_t^{np}, (1 - \beta \odot \gamma^p)x_t^p, (1 + \beta \odot \sigma^{np})y_t^{np}, \right. \\ \left. (1 + \beta \odot \sigma^p)y_t^p \right) \in T_t, \beta \in \mathbb{R} \\ \infty \quad \text{else} \end{cases} \quad (2.6)$$

where  $(\gamma, \sigma) \in [0, 1]^n \times [0, 1]^{m^{np}} \times [-1, 0]^{m^p}$ , such that  $\gamma = (\gamma^{np}, \gamma^p) \in [0, 1]^n$  and  $\sigma = (\sigma^{np}, \sigma^p) \in [0, 1]^{m^{np}} \times [-1, 0]^{m^p}$ . In addition, the symbol  $\odot$  denotes element-wise product (Hadamard product).

From the definition above, the proposition below presents the properties of the additive distance function.

**Proposition 2.5** For any  $(\gamma, \sigma) \in [0, 1]^n \times [0, 1]^{m^{np}} \times [-1, 0]^{m^p}$  and any  $(x_t, y_t) \in \mathbb{R}_+^{n+m}$  with  $x_t = (x_t^p, x_t^{np}) \in \mathbb{R}_+^n$  and  $y_t = (y_t^{np}, y_t^p) \in \mathbb{R}_+^m$ , the multiplicative distance function  $\Xi(x, y)$  (b.1) fully characterises the production set, (b.2) is equal to 0 if the production unit belongs to the efficient frontier, (b.3) is homogeneous of degree 0 under a constant returns-to-scale, (b.4) is satisfies the translation homotheticity condition, (b.5) is invariant with respect to the unit of measurement and, (b.6) is is non-increasing in no polluting outputs and non-decreasing in polluting outputs, in polluting and no polluting inputs under a B-disposal assumption.

See Appendix 1 for the proof.

Based upon the definition above and subjected to the parameters  $\gamma$  and  $\sigma$ , we introduce input and/or output sub-vectors environmental disaggregated additive efficiency measures in either polluting or no polluting orientation.

**Proposition 2.6** For any  $(x_t, y_t) \in \mathbb{R}_+^{n+m}$ , such that  $x_t = (x_t^p, x_t^{np}) \in \mathbb{R}_+^n$  and  $y_t = (y_t^{np}, y_t^p) \in \mathbb{R}_+^m$ , we have:

- i.  $\Xi_t^{\gamma, \sigma}(x_t, y_t) \equiv \Xi_t^{i^{np}}(x_t, y_t)$ , if  $\gamma^{np} = 1$  and  $\gamma^p = \sigma^{np} = \sigma^p = 0$ .
- ii.  $\Xi_t^{\gamma, \sigma}(x_t, y_t) \equiv \Xi_t^{i^p}(x_t, y_t)$ , if  $\gamma^p = 1$  and  $\gamma^{np} = \sigma^p = \sigma^{np} = 0$ .

iii.  $\Xi_t^{\gamma, \sigma}(x_t, y_t) \equiv \Xi_t^{\sigma^{np}}(x_t, y_t)$ , if  $\gamma^p = \gamma^{np} = \sigma^p = 0$  and  $\sigma^{np} = 1$ .

iv.  $\Xi_t^{\gamma, \sigma}(x_t, y_t) \equiv \Xi_t^{\sigma^p}(x_t, y_t)$ , if  $\gamma^p = \gamma^{np} = \sigma^{np} = 0$  and  $\sigma^p = -1$ .

These efficiency measures inherit the basic structure of the directional distance functions. Figures 5 and 6 illustrate input and output sub-vectors polluting and no polluting additive distance functions.

### FIGURES 5-6 ABOUT HERE

Since, the proposition above defined the input and output sub-vectors environmental disaggregated additive distance functions, we suggest some equivalences with the input and output sub-vectors multiplicative efficiency measures. These results are presented in the proposition below.

**Proposition 2.7** For any  $(x_t, y_t) \in \mathbb{R}_+^{n+m}$ , such that  $x_t = (x_t^p, x_t^{np}) \in \mathbb{R}_+^n$  and  $y_t = (y_t^{np}, y_t^p) \in \mathbb{R}_+^m$ ,

i.  $\Xi_t^{i^{np}}(x_t, y_t) \equiv 1 - \Psi_t^{i^{np}}(x_t, y_t)$ .

ii.  $\Xi_t^{i^p}(x_t, y_t) \equiv 1 - \Psi_t^{i^p}(x_t, y_t)$ .

iii.  $\Xi_t^{o^p}(x_t, y_t) \equiv 1 - \Psi_t^{o^p}(x_t, y_t)$ .

iv.  $\Xi_t^{o^{np}}(x_t, y_t) \equiv [\Psi_t^{o^{np}}(x_t, y_t)]^{-1} - 1$ .

Notice that  $\Psi_t^{i^{np}}(\cdot)$ ,  $\Psi_t^{i^p}(\cdot)$  and  $\Psi_t^{o^p}(\cdot)$  inherit the basic structure of the input sub-vector Debreu-Farrell efficiency measure. In addition,  $\Xi_t^{i^{np}}(\cdot)$ ,  $\Xi_t^{i^p}(\cdot)$  and  $\Xi_t^{o^p}(\cdot)$  take the form of the input sub-vector proportional directional distance function. Hence, the aforementioned statements *i.-iii.* are immediate (Chambers et al., 1996; Bricc, 1997). A similar reasoning holds for the statement *iv.*. Indeed,  $[\Psi_t^{o^{np}}(\cdot)]^{-1}$  (respectively,  $\Xi_t^{o^{np}}(\cdot)$ ) inherits the basic structure of the output sub-vector Shephard (respectively, proportional directional) distance function.

The convex and non convex mathematical programs of the additive distance function, through the DEA framework, are presented in Appendix 2.

### 3 Disaggregated Environmental Productivity Analysis

In the next subsections, we introduce Environmental Disaggregated Hicks-Moorsteen (EDHM) and Environmental Disaggregated Luenberger-Hicks-Moorsteen (EDLHM) productivity measures. These ratio- and difference-based productivity measures are the generalized formulation of Bjurek (1996) and of Briec and Kerstens (2004) productivity measures. Indeed, we propose to disaggregate inputs and outputs into no polluting and polluting ones.

#### 3.1 Disaggregation of Environmental Hicks-Moorsteen Index

The Hicks-Moorsteen (HM) productivity index was first introduced by Bjurek (1996). This productivity measure is defined as the ratio of a Malmquist output quantity index over a Malmquist input quantity index. Therefore, we propose the EDHM productivity measure which is based upon environmental disaggregated Malmquist quantity indices, in the next definition.

**Definition 3.1** *Let  $T_t$  be a production technology that satisfies properties T1 – T3 and T5. For any  $(x_t, y_t) \in \mathbb{R}_+^{n+m}$ , where  $x_t = (x_t^p, x_t^{np}) \in \mathbb{R}_+^n$  and  $y_t = (y_t^p, y_t^{np}) \in \mathbb{R}_+^m$ , the Environmental Disaggregated Hicks-Moorsteen index for period ( $t$ ) is defined as follows:*

$$EDHM_t(x_t, y_t, x_{t+1}, y_{t+1}) = \frac{EDMO_t(x_t, y_t, y_{t+1})}{EDMI_t(x_t, x_{t+1}, y_t)} \quad (3.1)$$

such that  $EDMO_t$  and  $EDMI_t$  are respectively output and input Malmquist quantity indices for the period ( $t$ ).

Remark that,

$$\begin{aligned} EDMO_t(x_t, y_t, y_{t+1}) &= MO_t^{np}(x_t, y_t, y_{t+1}^{np}) \times MO_t^p(x_t, y_t, y_{t+1}^p) \\ &= \frac{\Psi_t^{o^{np}}(x_t^{np}, x_t^p, y_{t+1}^{np}, y_t^p)}{\Psi_t^{o^{np}}(x_t^{np}, x_t^p, y_t^{np}, y_t^p)} \times \frac{\Psi_t^{o^p}(x_t^{np}, x_t^p, y_t^{np}, y_{t+1}^p)}{\Psi_t^{o^p}(x_t^{np}, x_t^p, y_t^{np}, y_t^p)}. \end{aligned} \quad (3.2)$$

In (3.2), cross-time polluting and no polluting multiplicative distance functions (Figure 8) are defined as:

$$\Psi_t^{o^p}(x_t^{np}, x_t^p, y_{t+1}^{np}, y_t^p) = \inf_{\theta} \{ \theta > 0 : (x_t^{np}, x_t^p, y_t^{np}, \theta y_{t+1}^p) \in T_t \}$$

and

$$\Psi_t^{o^{np}}(x_t^{np}, x_t^p, y_{t+1}^{np}, y_t^p) = \inf_{\theta} \left\{ \theta > 0 : \left( x_t^{np}, x_t^p, \frac{y_{t+1}^{np}}{\theta}, y_t^p \right) \in T_t \right\}.$$

These efficiency measures estimate the performance of the fictive points  $(x_t^{np}, x_t^p, y_{t+1}^{np}, y_t^p)$  and  $(x_t^{np}, x_t^p, y_t^{np}, y_{t+1}^p)$  with respect to the production technology of period  $(t)$ . Notice that in such a case, cross-time environmental disaggregated multiplicative efficiency measures coincide to the sub-vectors polluting and no polluting Shephard distance function of Färe et al. (2004).

Assume that the no polluting Malmquist quantity index is greater than unity. In such a case, more economic outputs are produced in period  $(t + 1)$  than in period  $(t)$  for given input and polluting output vectors. Conversely, if the no polluting Malmquist output quantity index is smaller than unity then, the reverse reasoning holds.

If the polluting Malmquist output quantity index is greater than unity then, less polluting outputs are produced in period  $(t + 1)$  than in period  $(t)$  for given level of inputs and no polluting outputs. Reciprocally, if the polluting Malmquist output quantity index is smaller than unity then the converse reasoning is applied.

$$\begin{aligned} EDM I_t(x_t, x_{t+1}, y_t) &= MI_t^{np}(x_t, x_{t+1}^{np}, y_t) \times MI_t^p(x_t, x_{t+1}^p, y_t) \\ &= \frac{\Psi_t^{i^{np}}(x_{t+1}^{np}, x_t^p, y_t^{np}, y_t^p)}{\Psi_t^{i^{np}}(x_t^{np}, x_t^p, y_t^{np}, y_t^p)} \times \frac{\Psi_t^{i^p}(x_t^{np}, x_{t+1}^p, y_t^{np}, y_t^p)}{\Psi_t^{i^p}(x_t^{np}, x_t^p, y_t^{np}, y_t^p)}. \end{aligned} \quad (3.3)$$

In the case of (3.3), cross-time environmental disaggregated multiplicative distance functions (Figure 7) are defined as:

$$\Psi_t^{i^p}(x_t^{np}, x_{t+1}^p, y_t^{np}, y_t^p) = \inf_{\theta} \left\{ \theta > 0 : (x_t^{np}, \theta x_{t+1}^p, y_t^{np}, y_t^p) \in T_t \right\}$$

and

$$\Psi_t^{i^{np}}(x_t^{np}, x_{t+1}^p, y_t^{np}, y_t^p) = \inf_{\theta} \left\{ \theta > 0 : (\theta x_{t+1}^{np}, x_t^p, y_t^{np}, y_t^p) \in T_t \right\}.$$

These efficiency measures estimate the input oriented performance of the sub-vectors  $(x_t^{np}, x_{t+1}^p, y_t^{np}, y_t^p)$  and  $(x_{t+1}^{np}, x_t^p, y_t^{np}, y_t^p)$  with respect to the production technology of period  $(t)$ . Remark that in such a case, the no polluting and the polluting input oriented distance functions are similar to the input Debreu (1951)-Farrell (1957) measure of technical efficiency.

Consider that the no polluting Malmquist input quantity index is smaller than unity then, less no polluting inputs are needed in period  $(t + 1)$  than in period  $(t)$  to produce

the same level of outputs and for a given amount of polluting inputs. Between the periods  $(t)$  and  $(t + 1)$  the firm operates managerial efforts (positive adaptation) to adopt innovative technology that can mitigate pollution for a given amount of desirable production. The converse reasoning holds if the no polluting Malmquist input quantity index is greater than unity.

Now, assume that the polluting Malmquist input quantity index is smaller than unity. In such a case, less polluting inputs are required in period  $(t + 1)$  than in period  $(t)$  for a given level of outputs. Thus, the reciprocal reasoning is applied when the polluting Malmquist input quantity index is greater than unity.

### FIGURES 7-8 ABOUT HERE

In addition, the EDHM of period  $(t + 1)$  is defined as:

$$EDHM_{t+1}(x_t, y_t, x_{t+1}, y_{t+1}) = \frac{EDMO_{t+1}(x_{t+1}, y_{t+1}, y_t)}{EDMI_{t+1}(x_t, x_{t+1}, y_{t+1})}, \quad (3.4)$$

where

$$\begin{aligned} EDMO_{t+1}(x_{t+1}, y_{t+1}, y_t) &= MO_{t+1}^{np}(x_{t+1}, y_{t+1}, y_t^{np}) \times MO_{t+1}^p(x_{t+1}, y_{t+1}, y_t^p) \\ &= \frac{\Psi_{t+1}^{o^{np}}(x_{t+1}^{np}, x_{t+1}^p, y_{t+1}^{np}, y_{t+1}^p)}{\Psi_{t+1}^{o^{np}}(x_{t+1}^{np}, x_{t+1}^p, y_t^{np}, y_t^p)} \times \frac{\Psi_{t+1}^{o^p}(x_{t+1}^{np}, x_{t+1}^p, y_{t+1}^{np}, y_{t+1}^p)}{\Psi_{t+1}^{o^p}(x_{t+1}^{np}, x_{t+1}^p, y_{t+1}^{np}, y_t^p)} \end{aligned} \quad (3.5)$$

and

$$\begin{aligned} EDMI_{t+1}(x_t, x_{t+1}, y_{t+1}) &= MI_{t+1}^{np}(x_{t+1}, y_{t+1}, y_t^{np}) \times MI_{t+1}^p(x_{t+1}, y_{t+1}, y_t^p) \\ &= \frac{\Psi_{t+1}^{i^{np}}(x_{t+1}^{np}, x_{t+1}^p, y_{t+1}^{np}, y_{t+1}^p)}{\Psi_{t+1}^{i^{np}}(x_t^{np}, x_{t+1}^p, y_{t+1}^{np}, y_{t+1}^p)} \times \frac{\Psi_{t+1}^{i^p}(x_{t+1}^{np}, x_{t+1}^p, y_{t+1}^{np}, y_{t+1}^p)}{\Psi_{t+1}^{i^p}(x_{t+1}^{np}, x_t^p, y_{t+1}^{np}, y_{t+1}^p)}. \end{aligned} \quad (3.6)$$

The global EDHM productivity measure is defined as the geometric mean of environmental disaggregated Hicks-Moorsteen indices over the periods  $(t, t + 1)$ .

**Proposition 3.2** *Let  $T_t$  be a production process that satisfies properties T1 – T3 and T5. For any consecutive time periods  $(t, t + 1)$  and for any  $(x_{t,t+1}, y_{t,t+1}) \in \mathbb{R}_+^{n+m}$ , where  $x_{t,t+1} = (x_{t,t+1}^{np}, x_{t,t+1}^p) \in \mathbb{R}_+^n$  and  $y_{t,t+1} = (y_{t,t+1}^{np}, y_{t,t+1}^p) \in \mathbb{R}_+^m$ , the global environmental disaggregated Hicks-Moorsteen productivity measure is defined as follows:*

$$\begin{aligned} &EDHM_{t,t+1}(x_t, y_t, x_{t+1}, y_{t+1}) \\ &= \left[ EDHM_t(x_t, y_t, x_{t+1}, y_{t+1}) \times EDHM_{t+1}(x_t, y_t, x_{t+1}, y_{t+1}) \right]^{\frac{1}{2}}. \end{aligned} \quad (3.7)$$

With respect to the proposition above, when the environmental disaggregated Hicks-Moorsteen productivity index is larger than unity then it shows both polluting and no-polluting productivity improvement. Reversely, if the environmental disaggregated Hicks-Moorsteen productivity index is smaller than unity then there exists productivity loss in polluting and no polluting dimensions.

The following result defines polluting and no polluting EDHM productivity indices.

**Proposition 3.3** For any  $(x_t, y_t) \in \mathbb{R}_+^{n+m}$ , such that  $x_t = (x_t^p, x_t^{np}) \in \mathbb{R}_+^n$  and  $y_t = (y_t^p, y_t^{np}) \in \mathbb{R}_+^m$ ,

i. if  $x_{t,t+1} \in \mathbb{R}_+^{np}$  and  $y_{t,t+1} \in \mathbb{R}_+^{mp}$  then,

$$EDHM_t(x_t, y_t, x_{t+1}, y_{t+1}) \equiv HM_t^p(x_t, y_t, x_{t+1}, y_{t+1}) \quad (3.8)$$

where  $x_{t,t+1} = x_{t,t+1}^p$  and  $y_{t,t+1} = y_{t,t+1}^p$ .

ii. if  $x_{t,t+1} \in \mathbb{R}_+^{n^{np}}$  and  $y_{t,t+1} \in \mathbb{R}_+^{m^{np}}$  then,

$$EDHM_t(x_t, y_t, x_{t+1}, y_{t+1}) \equiv HM_t^{np}(x_t, y_t, x_{t+1}, y_{t+1}), \quad (3.9)$$

where  $x_{t,t+1} = x_{t,t+1}^{np}$  and  $y_{t,t+1} = y_{t,t+1}^{np}$ .

Notice that if we solely consider the polluting components (inputs and outputs) then, the EDHM coincides to the polluting Hicks-Moorsteen productivity index. Conversely, if the EDHM is estimated with respect to no polluting input and output sub-vectors then it matches the no polluting Hicks-Moorsteen productivity measure.

*Proof of Proposition 3.3*

i. If  $x_{t,t+1} \in \mathbb{R}_+^{np}$  and  $y_{t,t+1} \in \mathbb{R}_+^{mp}$  then, the EDHM for the period ( $t$ ) is defined as,

$$EDHM_t(x_t^p, y_t^p, x_{t+1}^p, y_{t+1}^p) = \frac{MO_t^p(x_t, y_t, y_{t+1}^p)}{MI_t^p(x_t, y_t, x_{t+1}^p)}.$$

Indeed,  $MO_t^{np}(x_t^p, y_t^p) = MI_t^{np}(x_t^p, y_t^p) = 1$ . Consequently,

$$EDHM_t(x_t^p, y_t^p, x_{t+1}^p, y_{t+1}^p) \equiv HM_t^p(x_t, y_t, x_{t+1}, y_{t+1}).$$

ii. When  $x_{t,t+1} \in \mathbb{R}_+^{n^{np}}$  and  $y_{t,t+1} \in \mathbb{R}_+^{m^{np}}$  then, the EDHM for the period ( $t$ ) is defined as,

$$EDHM_t(x_t^{np}, y_t^{np}, x_{t+1}^{np}, y_{t+1}^{np}) = \frac{MO_t^{np}(x_t, y_t, y_{t+1}^{np})}{MI_t^{np}(x_t, y_t, x_{t+1}^{np})}.$$

Indeed,  $MO_t^p(x_t^{np}, y_t^{np}) = MI_t^p(x_t^{np}, y_t^{np}) = 1$ . Therefore,

$$EDHM_t(x_t^{np}, y_t^{np}, x_{t+1}^{np}, y_{t+1}^{np}) \equiv HM_t^{np}(x_t, y_t, x_{t+1}, y_{t+1}). \quad \square$$

### 3.2 Disaggregated Environmental Luenberger-Hicks-Moorsteen Productivity Indicator

Briec and Kerstens (2004) define the Luenberger-Hicks-Moorsteen (LHM) productivity indicator. This is a difference-based productivity measure between the output and the input Luenberger quantity indicators. In this subsection, we propose the Environmental Disaggregated Luenberger-Hicks-Moorsteen (EDLHM) productivity indicator which is a difference-based measure involving no polluting and polluting Luenberger quantity indicators.

**Definition 3.4** Let  $T_t$  be a production technology that satisfies properties T1 – T3 and T5. For any  $(x_t, y_t) \in \mathbb{R}_+^{n+m}$ , such that  $x_t = (x_t^p, x_t^{np}) \in \mathbb{R}_+^n$  and  $y_t = (y_t^p, y_t^{np}) \in \mathbb{R}_+^m$ , the Environmental Disaggregated Luenberger-Hicks-Moorsteen productivity measure for period  $(t)$  is defined as follows,

$$EDLHM_t(x_t, y_t, x_{t+1}, y_{t+1}) = EDLO_t(x_t, y_t, y_{t+1}) - EDLI_t(x_t, x_{t+1}, y_t). \quad (3.10)$$

Where  $EDLO_t$  and  $EDLI_t$  are environmental disaggregated output and input Luenberger quantity indicators for the period  $(t)$ .

Note that,

$$\begin{aligned} EDLO_t(x_t, y_t, y_{t+1}) &= LO_t^{np}(x_t, y_t, y_{t+1}^{np}) + LO_t^p(x_t, y_t, y_{t+1}^p) \\ &= (\Xi_t^{np}(x_t^{np}, x_t^p, y_t^{np}, y_t^p) - \Xi_t^{o np}(x_t^{np}, x_t^p, y_{t+1}^{np}, y_t^p)) + \\ &\quad (\Xi_t^{op}(x_t^{np}, x_t^p, y_t^{np}, y_t^p) - \Xi_t^{o p}(x_t^{np}, x_t^p, y_t^{np}, y_{t+1}^p)). \end{aligned} \quad (3.11)$$

In (3.11), cross-time no polluting and polluting additive distance functions between periods  $(t, t + 1)$  are defined as:

$$\Xi_t^{o np}(x_t^{np}, x_t^p, y_{t+1}^{np}, y_t^p) = \sup_{\beta} \{ \beta : (x_t^{np}, x_t^p, y_{t+1}^{np}(1 + \beta), y_t^p) \in T_t \}$$

and

$$\Xi_t^{o p}(x_t^{np}, x_t^p, y_t^{np}, y_{t+1}^p) = \sup_{\beta} \{ \beta : (x_t^{np}, x_t^p, y_t^{np}, y_{t+1}^p(1 - \beta)) \in T_t \}.$$

Therefore, the output oriented cross-time environmental disaggregated additive distance functions evaluate the efficiency of the sub-vectors  $(x_t^{np}, x_t^p, y_{t+1}^{np}, y_t^p)$  and  $(x_t^{np}, x_t^p, y_t^{np}, y_{t+1}^p)$  with respect to the production technology of period  $(t)$ .

If the no polluting output Luenberger quantity indicator is greater than zero then more no polluting outputs are produced in period  $(t + 1)$  than in period  $(t)$ , for a given level of inputs and polluting outputs. Thus, managerial efforts have been adopted to improve desirable

production. The reverse reasoning can be applied if the no polluting output Luenberger quantity indicator is smaller than zero.

Remark that when the polluting output Luenberger quantity indicator is greater than zero then less polluting outputs are produced between period  $(t+1)$  and period  $(t)$  for a fixed amount of inputs and no polluting outputs. Hence, positive adaptations have been applied to reduce the level of undesirable production. The reciprocal reasoning holds if the polluting output Luenberger quantity indicator is smaller than zero.

Notice that the environmental disaggregated input Luenberger quantity indicator of the period  $(t)$  is as follows:

$$\begin{aligned} EDLI_t(x_t, x_{t+1}, y_t) &= LI_t^{np}(x_t, x_{t+1}^{np}, y_t) + LI_t^p(x_t, x_{t+1}^p, y_t) \\ &= (\Xi_t^{inp}(x_{t+1}^{np}, x_t^p, y_t^{np}, y_t^p) - \Xi_t^{inp}(x_t^{np}, x_t^p, y_t^{np}, y_t^p)) + \\ &\quad (\Xi_t^{ip}(x_t^{np}, x_{t+1}^p, y_t^{np}, y_t^p) - \Xi_t^{ip}(x_t^{np}, x_t^p, y_t^{np}, y_t^p)). \end{aligned} \quad (3.12)$$

In the case of (3.12), cross-time no polluting and polluting additive distance functions are defined as:

$$\Xi_t^{inp}(x_{t+1}^{np}, x_t^p, y_t^{np}, y_t^p) = \sup_{\beta} \{ \beta : (x_{t+1}^{np}(1-\beta), x_t^p, y_t^{np}, y_t^p) \in T_t \}$$

and

$$\Xi_t^{ip}(x_t^{np}, x_{t+1}^p, y_t^{np}, y_t^p) = \sup_{\beta} \{ \beta : (x_t^{np}, x_{t+1}^p(1-\beta), y_t^{np}, y_t^p) \in T_t \}.$$

These efficiency measures estimate the performance of the fictive points  $(x_t^p, x_{t+1}^{np}, y_t^p, y_t^{np})$  and  $(x_{t+1}^p, x_t^{np}, y_t^p, y_t^{np})$  with respect to the production frontier of period  $(t)$ .

Remark that if the no polluting input Luenberger quantity indicator is smaller than zero then less no polluting inputs are used in period  $(t+1)$  than in period  $(t)$  for a given level of outputs and polluting inputs. In such a case, we can suppose that positive management has been adopted to reduce the use of no polluting inputs. The converse reasoning is applied when the no polluting Luenberger quantity indicator is greater than zero.

When the polluting input Luenberger quantity indicator is smaller than zero then less polluting inputs are needed between periods  $(t+1)$  and  $(t)$  for the same amount of outputs and no polluting inputs. Thus, managerial efforts have been implemented to reduce the use of polluting inputs. The reverse reasoning holds if the polluting Luenberger quantity indicator is greater than zero.



In the same vein, for the period  $(t + 1)$  the EDLHM productivity indicator is defined as:

$$EDLHM_{t+1}(x_t, y_t, x_{t+1}, y_{t+1}) = EDLO_{t+1}(x_{t+1}, y_t, y_{t+1}) - EDLI_{t+1}(x_t, x_{t+1}, y_{t+1}). \quad (3.13)$$

Where,

$$\begin{aligned} EDLO_{t+1}(x_{t+1}, y_t, y_{t+1}) &= LO_{t+1}^{np}(x_{t+1}, y_{t+1}, y_t^{np}) + LO_{t+1}^p(x_{t+1}, y_{t+1}, y_t^p) \\ &= \left( \Xi_{t+1}^{o^{np}}(x_{t+1}^{np}, x_{t+1}^p, y_t^{np}, y_{t+1}^p) - \Xi_{t+1}^{o^{np}}(x_{t+1}^{np}, x_{t+1}^p, y_{t+1}^{np}, y_{t+1}^p) \right) + \\ &\quad \left( \Xi_{t+1}^{o^p}(x_{t+1}^{np}, x_{t+1}^p, y_{t+1}^{np}, y_t^p) - \Xi_{t+1}^{o^p}(x_{t+1}^{np}, x_{t+1}^p, y_{t+1}^{np}, y_{t+1}^p) \right) \end{aligned} \quad (3.14)$$

and

$$\begin{aligned} EDLI_{t+1}(x_t, x_{t+1}, y_{t+1}) &= LI_{t+1}^{np}(x_{t+1}, y_{t+1}, x_t^{np}) + LI_{t+1}^p(x_{t+1}, y_{t+1}, x_t^p) \\ &= \left( \Xi_{t+1}^{i^{np}}(x_{t+1}^{np}, x_{t+1}^p, y_{t+1}^{np}, y_{t+1}^p) - \Xi_{t+1}^{i^{np}}(x_t^{np}, x_{t+1}^p, y_{t+1}^{np}, y_{t+1}^p) \right) + \\ &\quad \left( \Xi_{t+1}^{i^p}(x_{t+1}^{np}, x_{t+1}^p, y_{t+1}^{np}, y_{t+1}^p) - \Xi_{t+1}^{i^p}(x_{t+1}^{np}, x_t^p, y_{t+1}^{np}, y_{t+1}^p) \right). \end{aligned} \quad (3.15)$$

Global environmental disaggregated Luenberger-Hicks-Moorsteen productivity measure is defined as the arithmetic mean of EDLHM indicators for the periods  $(t)$  and  $(t + 1)$ .

**Proposition 3.5** *Let  $T_t$  be a production technology that satisfies assumptions T1 – T3 and T5. For any consecutive time periods  $(t, t + 1)$  and for any  $(x_{t,t+1}, y_{t,t+1}) \in \mathbb{R}_+^{n+m}$ , where  $x_{t,t+1} = (x_{t,t+1}^{np}, x_{t,t+1}^p) \in \mathbb{R}_+^n$  and  $y_{t,t+1} = (y_{t,t+1}^{np}, y_{t,t+1}^p) \in \mathbb{R}_+^m$ , the global environmental disaggregated Luenberger-Hicks-Moorsteen productivity measure is defined as follows:*

$$\begin{aligned} &EDLHM_{t,t+1}(x_t, y_t, x_{t+1}, y_{t+1}) \\ &= \frac{1}{2} \left[ EDLHM_t(x_t, y_t, x_{t+1}, y_{t+1}) + EDLHM_{t+1}(x_t, y_t, x_{t+1}, y_{t+1}) \right]. \end{aligned} \quad (3.16)$$

The EDLHM productivity measure shows environmental productivity improvement if it takes positive value. Reciprocally, if the EDLHM productivity indicator takes negative value then there exists environmental productivity deterioration.

The next proposition introduces polluting and no polluting EDLHM productivity indicators.

**Proposition 3.6** *For any  $(x_t, y_t) \in \mathbb{R}_+^{n+m}$ , such that  $x_t = (x_t^p, x_t^{np}) \in \mathbb{R}_+^n$  and  $y_t = (y_t^p, y_t^{np}) \in \mathbb{R}_+^m$ ,*

**i.** *if  $x_{t,t+1} \in \mathbb{R}_+^{n^p}$  and  $y_{t,t+1} \in \mathbb{R}_+^{m^p}$  then,*

$$EDLHM_t(x_t, y_t, x_{t+1}, y_{t+1}) \equiv LHM_t^p(x_t, y_t, x_{t+1}, y_{t+1}) \quad (3.17)$$

*where  $x_{t,t+1} = x_{t,t+1}^p$  and  $y_{t,t+1} = y_{t,t+1}^p$ .*

ii. if  $x_{t,t+1} \in \mathbb{R}_+^{np}$  and  $y_{t,t+1} \in \mathbb{R}_+^{mnp}$  then,

$$EDLHM_t(x_t, y_t, x_{t+1}, y_{t+1}) \equiv LHM_t^{np}(x_t, y_t, x_{t+1}, y_{t+1}), \quad (3.18)$$

where  $x_{t,t+1} = x_{t,t+1}^{np}$  and  $y_{t,t+1} = y_{t,t+1}^{np}$ .

Proposition 3.6 means that, if we solely consider polluting components then the EDLHM productivity indicator coincides to the polluting Luenberger-Hicks-Moorsteen indicator. Moreover, if we focus on no polluting sub-vectors then, the EDLHM productivity measure matches the no polluting Luenberger-Hicks-Moorsteen productivity indicator.

*Proof of Proposition 3.6*

i. Let us postulate that  $x_{t,t+1} \in \mathbb{R}_+^p$  and  $y_{t,t+1} \in \mathbb{R}_+^{m^p}$ . The EDLHM for the period ( $t$ ) is defined as:

$$EDLHM_t(x_t^p, y_t^p, x_{t+1}^p, y_{t+1}^p) = LO_t^p(x_t, y_t, y_{t+1}^p) - LI_t^p(x_t, y_t, x_{t+1}^p).$$

Indeed,  $LO_t^{np}(x_t^p, y_t^p) = LI_t^p(x_t^p, y_t^p) = 0$ . Therefore,

$$EDLHM_t(x_t^p, y_t^p, x_{t+1}^p, y_{t+1}^p) \equiv LHM_t^p(x_t, y_t, x_{t+1}, y_{t+1}).$$

ii. If  $x_{t,t+1} \in \mathbb{R}_+^{np}$  and  $y_{t,t+1} \in \mathbb{R}_+^{mnp}$  then, the EDLHM for the period ( $t$ ) is defined as:

$$EDLHM_t(x_t^{np}, y_t^{np}, x_{t+1}^{np}, y_{t+1}^{np}) = LO_t^{np}(x_t, y_t, y_{t+1}^{np}) - LI_t^{np}(x_t, y_t, x_{t+1}^{np}).$$

Where,  $LO_t^p(x_t^{np}, y_t^{np}) = LI_t^p(x_t^{np}, y_t^{np}) = 0$ . Consequently,

$$EDLHM_t(x_t^{np}, y_t^{np}, x_{t+1}^{np}, y_{t+1}^{np}) \equiv LHM_t^{np}(x_t, y_t, x_{t+1}, y_{t+1}). \quad \square$$

## 4 Decomposition of environmental disaggregated productivity measures

Decomposition and disaggregation analysis of productivity variation display complementary informations. Indeed, knowing the sources of environmental disaggregated productivity change allows to explore the main drivers of polluting and no polluting productivity variation.

### 4.1 Environmental disaggregated Hicks-Moorsten productivity index

The environmental disaggregated Hicks-Moorsteen productivity measure is a particular multiplicative complete index (O'Donnell, 2012). The aggregator functions of polluting and no

polluting components are multiplicative distance functions. Let us introduce a decomposition of the environmental disaggregated Hicks-Moorsten productivity index, in the line of Diewert and Fox (2017).

**Definition 4.1** *Let  $T_t$  be a production technology that satisfies properties T1 – T3 and T5. For any  $(x_t, y_t) \in \mathbb{R}_+^{n+m}$ , where  $x_t = (x_t^p, x_t^{np}) \in \mathbb{R}_+^n$  and  $y_t = (y_t^p, y_t^{np}) \in \mathbb{R}_+^m$ , the global environmental disaggregated Hicks-Moorsten productivity measure over periods  $(t, t + 1)$  is decomposed as follows:*

$$\begin{aligned} EDHM_{t,t+1} &= \Delta EDT_{t,t+1} \times \Delta EDE_{t,t+1} \times \Delta EDS_{t,t+1} \\ &= \Delta \mathcal{EDT}_{t,t+1} \times \Delta \mathcal{EDE}_{t,t+1} \times \Delta \mathcal{EDS}_{t,t+1}. \end{aligned} \quad (4.1)$$

Such that,

- i.  $\Delta EDT_{t,t+1}$  ( $\Delta \mathcal{EDT}_{t,t+1}$ ) is the environmental disaggregated technical change in the output (input) direction over periods  $(t, t + 1)$ .
- ii.  $\Delta EDE_{t,t+1}$  ( $\Delta \mathcal{EDE}_{t,t+1}$ ) is the environmental disaggregated efficiency variation in the output (input) direction between periods  $(t)$  and  $(t + 1)$ .
- iii.  $\Delta EDS_{t,t+1}$  ( $\Delta \mathcal{EDS}_{t,t+1}$ ) is the environmental disaggregated scale efficiency change in the output (input) direction over periods  $(t, t + 1)$ .

#### 4.1.1 Output orientation

In the output direction, the environmental disaggregated technical change over periods  $(t, t + 1)$  is defined below,

$$\Delta EDT_{t,t+1} = \Delta T_{t,t+1}^{o^{np}} \times \Delta T_{t,t+1}^{o^p}. \quad (4.2)$$

Where,

$$\Delta T_{t,t+1}^{o^{np}} = \left[ \frac{\Psi_t^{o^{np}}(x_t, y_t)}{\Psi_{t+1}^{o^{np}}(x_t, y_t)} \times \frac{\Psi_t^{o^{np}}(x_{t+1}, y_{t+1})}{\Psi_{t+1}^{o^{np}}(x_{t+1}, y_{t+1})} \right]^{\frac{1}{2}} \quad (4.3)$$

and

$$\Delta T_{t,t+1}^{o^p} = \left[ \frac{\Psi_t^{o^p}(x_t, y_t)}{\Psi_{t+1}^{o^p}(x_t, y_t)} \times \frac{\Psi_t^{o^p}(x_{t+1}, y_{t+1})}{\Psi_{t+1}^{o^p}(x_{t+1}, y_{t+1})} \right]^{\frac{1}{2}} \quad (4.4)$$

are respectively no polluting and polluting technical change in the output direction between periods  $(t, t + 1)$ .

If  $\Delta T_{t,t+1}^{o^{np}} > 1$  then, no polluting technological progress arises in the output direction over periods  $(t, t+1)$ . Moreover, when  $\Delta T_{t,t+1}^{o^p} > 1$  then, polluting technical improvement occurs in the output dimension between period  $(t)$  and period  $(t+1)$ . In such a case,  $\Delta EDT_{t,t+1} > 1$  and environmental disaggregated technological advance arises in the output direction over periods  $(t, t+1)$ ; see Appendix 3 (Table 1).

In the same vein, the output environmental disaggregated efficiency change between periods  $(t, t+1)$  is defined below,

$$\Delta EDE_{t,t+1} = \Delta EC_{t,t+1}^{o^{np}} \times \Delta EC_{t,t+1}^{o^p}. \quad (4.5)$$

Such that,

$$\Delta EC_{t,t+1}^{o^{np}} = \frac{\Psi_{t+1}^{o^{np}}(x_{t+1}, y_{t+1})}{\Psi_t^{o^{np}}(x_t, y_t)} \quad (4.6)$$

and

$$\Delta EC_{t,t+1}^{o^p} = \frac{\Psi_{t+1}^{o^p}(x_{t+1}, y_{t+1})}{\Psi_t^{o^p}(x_t, y_t)} \quad (4.7)$$

are respectively no polluting and polluting output efficiency variation over periods  $(t, t+1)$ .

If  $\Delta EC_{t,t+1}^{o^{np}} > 1$  then, no polluting efficiency progress occurs in the output direction between periods  $(t, t+1)$ . In addition, when  $\Delta EC_{t,t+1}^{o^p} > 1$  then, polluting efficiency improvement arises in the output dimension over periods  $(t)$  and  $(t+1)$ . It follows that,  $\Delta EDE_{t,t+1} > 1$  and environmental disaggregated efficiency growth appears among periods  $(t)$  and  $(t+1)$ ; see Appendix 3 (Table 1).

The expression of the scale efficiency change in the output direction between periods  $(t)$  and  $(t+1)$  is displayed in the next result. Hence, from the residual, we have:

$$\Delta EDS_{t,t+1} = EDHM_{t,t+1} \times [\Delta EDT_{t,t+1} \times \Delta EDE_{t,t+1}]^{-1}, \quad (4.8)$$

where  $\Delta EDS_{t,t+1}$  is the scale efficiency variation in the output direction.

Remark that if there is no efficiency variation ( $\Delta EDE_{t,t+1} = 1$ ) and if no technical change arises ( $\Delta EDT_{t,t+1} = 1$ ) between periods  $(t)$  and  $(t+1)$  then, the productivity change (gain or loss) is solely provided by the environmental scale efficiency variation ( $\Delta EDS_{t,t+1} = EDHM_{t,t+1}$ ). In that case, the productivity change is the movement of the production unit along the production frontier since the production technology does not shift and the production unit is technically efficient.

The scale efficiency change in output direction results from the scale efficiency variation

in no polluting and polluting outputs directions such as:

$$\Delta EDS_{t,t+1} = \Delta SE_{t,t+1}^{o^{np}} \times \Delta SE_{t,t+1}^{o^p}. \quad (4.9)$$

Thus, from the residuals we have:

$$\begin{aligned} \Delta SE_{t,t+1}^{o^{np}} = & \left[ \frac{\Psi_t^{o^{np}}(x_t^{np}, x_t^p, y_{t+1}^{np}, y_t^p)}{\Psi_t^{o^{np}}(x_{t+1}, y_{t+1})} \times \frac{\Psi_t^{i^{np}}(x_{t+1}^{np}, x_t^p, y_t^{np}, y_t^p)}{\Psi_t^{i^{np}}(x_t, y_t)} \right. \\ & \left. \times \frac{\Psi_{t+1}^{o^{np}}(x_t, y_t)}{\Psi_{t+1}^{o^{np}}(x_{t+1}^{np}, x_{t+1}^p, y_t^{np}, y_{t+1}^p)} \times \frac{\Psi_{t+1}^{i^{np}}(x_{t+1}, y_{t+1})}{\Psi_{t+1}^{i^{np}}(x_t^{np}, x_{t+1}^p, y_{t+1}^{np}, y_{t+1}^p)} \right]^{\frac{1}{2}} \end{aligned} \quad (4.10)$$

and,

$$\begin{aligned} \Delta SE_{t,t+1}^{o^p} = & \left[ \frac{\Psi_t^{o^p}(x_t^{np}, x_t^p, y_t^{np}, y_{t+1}^p)}{\Psi_t^{o^p}(x_{t+1}, y_{t+1})} \times \frac{\Psi_t^{i^p}(x_t^{np}, x_{t+1}^p, y_t^{np}, y_t^p)}{\Psi_t^{i^p}(x_t, y_t)} \right. \\ & \left. \times \frac{\Psi_{t+1}^{o^p}(x_t, y_t)}{\Psi_{t+1}^{o^p}(x_{t+1}^{np}, x_{t+1}^p, y_{t+1}^{np}, y_t^p)} \times \frac{\Psi_{t+1}^{i^p}(x_{t+1}, y_{t+1})}{\Psi_{t+1}^{i^p}(x_{t+1}^{np}, x_t^p, y_{t+1}^{np}, y_{t+1}^p)} \right]^{\frac{1}{2}}. \end{aligned} \quad (4.11)$$

The distillation procedure allows to differentiate the input and the output scale efficiency variation over time. To do that from the no polluting output direction, consider the following no polluting outputs projections:

$$\bar{y}_t^{np} = y_t^{np} \cdot [\Psi_t^{o^{np}}(x_t, y_t)]^{-1},$$

$$\bar{y}_{t+1}^{np} = y_{t+1}^{np} \cdot [\Psi_{t+1}^{o^{np}}(x_{t+1}, y_{t+1})]^{-1},$$

$$\hat{y}_t^{np} = y_t^{np} \cdot [\Psi_{t+1}^{o^{np}}(x_t, y_t)]^{-1},$$

$$\hat{y}_{t+1}^{np} = y_{t+1}^{np} \cdot [\Psi_t^{o^{np}}(x_{t+1}, y_{t+1})]^{-1}.$$

Thus, the distilled expression of the scale efficiency variation from no polluting outputs standpoint is as follows:

$$\begin{aligned} \Delta SE_{t,t+1}^{o^{np}} = & \left[ \frac{\Psi_t^{o^{np}}(x_t^{np}, x_t^p, \hat{y}_{t+1}^{np}, y_t^p)}{\Psi_t^{o^{np}}(x_t^{np}, x_t^p, \bar{y}_t^{np}, y_t^p)} \times \frac{\Psi_t^{i^{np}}(x_{t+1}^{np}, x_t^p, y_t^{np}, y_t^p)}{\Psi_t^{i^{np}}(x_t, y_t)} \right. \\ & \left. \times \frac{\Psi_{t+1}^{o^{np}}(x_{t+1}^{np}, x_{t+1}^p, \bar{y}_{t+1}^{np}, y_{t+1}^p)}{\Psi_{t+1}^{o^{np}}(x_{t+1}^{np}, x_{t+1}^p, \hat{y}_t^{np}, y_{t+1}^p)} \times \frac{\Psi_{t+1}^{i^{np}}(x_{t+1}, y_{t+1})}{\Psi_{t+1}^{i^{np}}(x_t^{np}, x_{t+1}^p, y_{t+1}^{np}, y_{t+1}^p)} \right]^{\frac{1}{2}} \\ = & [\Delta SE_t^{o^{np}} \times \Delta SE_{t+1}^{o^{np}}]^{\frac{1}{2}}. \end{aligned} \quad (4.12)$$

We can also give a distilled definition of the scale efficiency change in polluting outputs

direction. However, it is first necessary to introduce the polluting outputs projection below:

$$\bar{y}_t^p = y_t^p \cdot \Psi_t^{op}(x_t, y_t),$$

$$\bar{y}_{t+1}^p = y_{t+1}^p \cdot \Psi_{t+1}^{op}(x_{t+1}, y_{t+1}),$$

$$\hat{y}_t^p = y_t^p \cdot \Psi_{t+1}^{op}(x_t, y_t),$$

$$\hat{y}_{t+1}^p = y_{t+1}^p \cdot \Psi_t^{op}(x_{t+1}, y_{t+1}).$$

Hence, multiplying and dividing respectively  $\Psi_t^{op}(x_t, y_t)$  and  $\Psi_t^{op}(x_t, y_t)$  in the polluting outputs residual yield the following distilled scale efficiency change in polluting outputs direction:

$$\begin{aligned} \Delta SE_{t,t+1}^{op} &= \left[ \frac{\Psi_t^{op}(x_t^{np}, x_t^p, y_t^{np}, \hat{y}_{t+1}^p)}{\Psi_t^{op}(x_t^{np}, x_t^p, y_t^{np}, \bar{y}_t^p)} \times \frac{\Psi_t^{ip}(x_t^{np}, x_{t+1}^p, y_t^{np}, y_t^p)}{\Psi_t^{ip}(x_t, y_t)} \right. \\ &\quad \times \left. \frac{\Psi_{t+1}^{op}(x_{t+1}^{np}, x_{t+1}^p, y_{t+1}^{np}, \bar{y}_{t+1}^p)}{\Psi_{t+1}^{op}(x_{t+1}^{np}, x_{t+1}^p, y_{t+1}^{np}, \hat{y}_t^p)} \times \frac{\Psi_{t+1}^{ip}(x_{t+1}, y_{t+1})}{\Psi_{t+1}^{ip}(x_{t+1}^{np}, x_t^p, y_{t+1}^{np}, y_{t+1}^p)} \right]^{\frac{1}{2}} \\ &= [\Delta SE_t^{op} \times \Delta SE_{t+1}^{op}]^{\frac{1}{2}}. \end{aligned} \quad (4.13)$$

Remark that when  $\Delta EDS_{t,t+1} = 1$  then, the production unit operates at the optimal scale in the output direction. Besides, if  $\Delta EDS_{t,t+1} \neq 1$  then, the observation adopted some scale adjustments that induce productivity variation between periods ( $t$ ) and ( $t + 1$ ).

Several cases of environmental disaggregated scale efficiency change in the output direction can occur and they are displayed in Appendix 3 (Table 1).

#### 4.1.2 Input orientation

The environmental disaggregated technical change in the input direction between periods ( $t, t + 1$ ) is defined as follows,

$$\Delta \mathcal{EDT}_{t,t+1} = \Delta \mathcal{T}_{t,t+1}^{inp} \times \Delta \mathcal{T}_{t,t+1}^{ip}. \quad (4.14)$$

Such that,

$$\Delta \mathcal{T}_{t,t+1}^{inp} = \left[ \frac{\Psi_t^{inp}(x_t, y_t)}{\Psi_{t+1}^{inp}(x_t, y_t)} \times \frac{\Psi_t^{inp}(x_{t+1}, y_{t+1})}{\Psi_{t+1}^{inp}(x_{t+1}, y_{t+1})} \right]^{\frac{1}{2}} \quad (4.15)$$

and

$$\Delta\mathcal{T}_{t,t+1}^{ip} = \left[ \frac{\Psi_t^{ip}(x_t, y_t)}{\Psi_{t+1}^{ip}(x_t, y_t)} \times \frac{\Psi_t^{ip}(x_{t+1}, y_{t+1})}{\Psi_{t+1}^{ip}(x_{t+1}, y_{t+1})} \right]^{\frac{1}{2}} \quad (4.16)$$

show respectively no polluting and polluting technical change in the input direction over periods  $(t, t+1)$ .

If  $\Delta\mathcal{T}_{t,t+1}^{inp} > 1$  (respectively  $\Delta\mathcal{T}_{t,t+1}^{ip} > 1$ ) then, no polluting (respectively polluting) input technological progress arises between periods  $(t)$  and  $(t+1)$ . It follows that,  $\Delta\mathcal{ED}\mathcal{T}_{t,t+1} > 1$  and environmental disaggregated technological improvement occurs in the input direction over periods  $(t, t+1)$ ; see Appendix 3 (Table 2).

The environmental disaggregated efficiency variation in the input direction over periods  $(t, t+1)$  is defined as follows,

$$\Delta\mathcal{ED}\mathcal{E}_{t,t+1} = \Delta\mathcal{EC}_{t,t+1}^{inp} \times \Delta\mathcal{EC}_{t,t+1}^{ip}. \quad (4.17)$$

Where,

$$\Delta\mathcal{EC}_{t,t+1}^{inp} = \frac{\Psi_{t+1}^{inp}(x_{t+1}, y_{t+1})}{\Psi_t^{inp}(x_t, y_t)} \quad (4.18)$$

and

$$\Delta\mathcal{EC}_{t,t+1}^{ip} = \frac{\Psi_{t+1}^{ip}(x_{t+1}, y_{t+1})}{\Psi_t^{ip}(x_t, y_t)} \quad (4.19)$$

are respectively no polluting and polluting efficiency change in the input direction between periods  $(t, t+1)$ .

If  $\Delta\mathcal{EC}_{t,t+1}^{inp} > 1$  (respectively  $\Delta\mathcal{EC}_{t,t+1}^{ip} > 1$ ) then, no polluting (respectively polluting) input efficiency improvement occurs over periods  $(t, t+1)$ . In such a case,  $\Delta\mathcal{ED}\mathcal{E}_{t,t+1} > 1$  and environmental disaggregated efficiency progress arises between periods  $(t)$  and  $(t+1)$ ; see Appendix 3 (Table 2).

The scale efficiency change in the input direction between periods  $(t, t+1)$  is exposed in the following result. Indeed, the residual allows to provide the definition below:

$$\Delta\mathcal{ED}\mathcal{S}_{t,t+1} = EDHM_{t,t+1} \times [\Delta\mathcal{ED}\mathcal{T}_{t,t+1} \times \Delta\mathcal{ED}\mathcal{E}_{t,t+1}]^{-1}, \quad (4.20)$$

where  $\Delta\mathcal{ED}\mathcal{S}_{t,t+1}$  is the scale efficiency variation in input direction.

Note that if no efficiency variation arises ( $\Delta\mathcal{ED}\mathcal{E}_{t,t+1} = 1$ ) and if there is no technical change ( $\Delta\mathcal{ED}\mathcal{T}_{t,t+1} = 1$ ) between periods  $(t)$  and  $(t+1)$  then, the productivity variation is the result of the environmental scale efficiency change ( $\Delta\mathcal{ED}\mathcal{S}_{t,t+1} = EDHM_{t,t+1}$ ). In such a case, the productivity change depicts the movement of the production unit along the

production frontier as the production technology does not move and the production unit is on the boundary of the technology.

From the input direction, the scale efficiency change is composed by the scale efficiency variation in no polluting and polluting components as follows:

$$\Delta \mathcal{E} \mathcal{D} \mathcal{S}_{t,t+1} = \Delta \mathcal{S} \mathcal{E}_{t,t+1}^{i^{np}} \times \Delta \mathcal{S} \mathcal{E}_{t,t+1}^{i^p}. \quad (4.21)$$

And from the residuals we respectively have:

$$\begin{aligned} \Delta \mathcal{S} \mathcal{E}_{t,t+1}^{i^{np}} = & \left[ \frac{\Psi_t^{o^{np}}(x_t^{np}, x_t^p, y_{t+1}^{np}, y_t^p)}{\Psi_t^{o^{np}}(x_t, y_t)} \times \frac{\Psi_t^{i^{np}}(x_{t+1}^{np}, x_t^p, y_t^{np}, y_t^p)}{\Psi_t^{i^{np}}(x_{t+1}, y_{t+1})} \right. \\ & \left. \times \frac{\Psi_{t+1}^{o^{np}}(x_{t+1}, y_{t+1})}{\Psi_{t+1}^{o^{np}}(x_{t+1}^{np}, x_{t+1}^p, y_{t+1}^{np}, y_{t+1}^p)} \times \frac{\Psi_{t+1}^{i^{np}}(x_t, y_t)}{\Psi_{t+1}^{i^{np}}(x_t^{np}, x_{t+1}^p, y_{t+1}^{np}, y_{t+1}^p)} \right]^{\frac{1}{2}} \end{aligned} \quad (4.22)$$

and,

$$\begin{aligned} \Delta \mathcal{S} \mathcal{E}_{t,t+1}^{i^p} = & \left[ \frac{\Psi_t^{o^p}(x_t^{np}, x_t^p, y_t^{np}, y_{t+1}^p)}{\Psi_t^{o^p}(x_t, y_t)} \times \frac{\Psi_t^{i^p}(x_t^{np}, x_{t+1}^p, y_t^{np}, y_t^p)}{\Psi_t^{i^p}(x_{t+1}, y_{t+1})} \right. \\ & \left. \times \frac{\Psi_{t+1}^{o^p}(x_{t+1}, y_{t+1})}{\Psi_{t+1}^{o^p}(x_{t+1}^{np}, x_{t+1}^p, y_{t+1}^{np}, y_{t+1}^p)} \times \frac{\Psi_{t+1}^{i^p}(x_t, y_t)}{\Psi_{t+1}^{i^p}(x_{t+1}^{np}, x_t^p, y_{t+1}^{np}, y_{t+1}^p)} \right]^{\frac{1}{2}}. \end{aligned} \quad (4.23)$$

The distillation of these residuals in no polluting and polluting inputs directions allows to distinguish the scale efficiency change provided by inputs and outputs components. To do so, let us define the following no polluting inputs projections:

$$\bar{x}_t^{np} = x_t^{np} \cdot \Psi_t^{i^{np}}(x_t, y_t),$$

$$\bar{x}_{t+1}^{np} = x_{t+1}^{np} \cdot \Psi_{t+1}^{i^{np}}(x_{t+1}, y_{t+1}),$$

$$\hat{x}_t^{np} = x_t^{np} \cdot \Psi_{t+1}^{i^{np}}(x_t, y_t),$$

$$\hat{x}_{t+1}^{np} = x_{t+1}^{np} \cdot \Psi_t^{i^{np}}(x_{t+1}, y_{t+1}).$$

Hence, multiplying and dividing respectively  $\Psi_t^{i^{np}}(x_t, y_t)$  and  $\Psi_{t+1}^{i^{np}}(x_{t+1}, y_{t+1})$  in  $\Delta \mathcal{S} \mathcal{E}_{t,t+1}^{i^{np}}$



provide the distilled expression of the no polluting input scale efficiency change as below:

$$\begin{aligned}\Delta\mathcal{SE}_{t,t+1}^{inp} &= \left[ \frac{\Psi_t^{inp}(x_t^{np}, x_t^p, y_{t+1}^{np}, y_t^p)}{\Psi_t^{inp}(x_t, y_t)} \times \frac{\Psi_t^{inp}(\hat{x}_{t+1}^{np}, x_t^p, y_t^{np}, y_t^p)}{\Psi_t^{inp}(\bar{x}_t^{np}, x_t^p, y_t^{np}, y_t^p)} \right. \\ &\quad \times \left. \frac{\Psi_{t+1}^{inp}(x_{t+1}, y_{t+1})}{\Psi_{t+1}^{inp}(x_{t+1}^{np}, x_{t+1}^p, y_{t+1}^{np}, y_{t+1}^p)} \times \frac{\Psi_{t+1}^{inp}(\bar{x}_{t+1}^{np}, x_{t+1}^p, y_{t+1}^{np}, y_{t+1}^p)}{\Psi_{t+1}^{inp}(\hat{x}_t^{np}, x_{t+1}^p, y_{t+1}^{np}, y_{t+1}^p)} \right]^{\frac{1}{2}} \\ &= [\Delta\mathcal{SE}_t^{inp} \times \Delta\mathcal{SE}_{t+1}^{inp}]^{\frac{1}{2}}.\end{aligned}\tag{4.24}$$

As for the case of no polluting inputs, we can distil the residual of polluting inputs. Thus, it is necessary to introduce the following polluting inputs projections:

$$\bar{x}_t^p = x_t^p \cdot \Psi_t^{ip}(x_t, y_t),$$

$$\bar{x}_{t+1}^p = x_{t+1}^p \cdot \Psi_{t+1}^{ip}(x_{t+1}, y_{t+1}),$$

$$\hat{x}_t^p = x_t^p \cdot \Psi_{t+1}^{ip}(x_t, y_t),$$

$$\hat{x}_{t+1}^p = x_{t+1}^p \cdot \Psi_t^{ip}(x_{t+1}, y_{t+1}).$$

Once again, the multiplication and the division of respectively  $\Psi_t^{ip}(x_t, y_t)$  and  $\Psi_{t+1}^{ip}(x_{t+1}, y_{t+1})$  in  $\Delta\mathcal{SE}_{t,t+1}^{inp}$  allows to propose the following scale efficiency change in polluting input direction:

$$\begin{aligned}\Delta\mathcal{SE}_{t,t+1}^{ip} &= \left[ \frac{\Psi_t^{op}(x_t^{np}, x_t^p, y_t^{np}, y_{t+1}^p)}{\Psi_t^{op}(x_t, y_t)} \times \frac{\Psi_t^{ip}(x_t^{np}, \hat{x}_{t+1}^p, y_t^{np}, y_t^p)}{\Psi_t^{ip}(x_t^{np}, \bar{x}_t^p, y_t^{np}, y_t^p)} \right. \\ &\quad \times \left. \frac{\Psi_{t+1}^{op}(x_{t+1}, y_{t+1})}{\Psi_{t+1}^{op}(x_{t+1}^{np}, x_{t+1}^p, y_{t+1}^{np}, y_t^p)} \times \frac{\Psi_{t+1}^{ip}(x_{t+1}^{np}, \bar{x}_{t+1}^p, y_{t+1}^{np}, y_{t+1}^p)}{\Psi_{t+1}^{ip}(x_{t+1}^{np}, \hat{x}_t^p, y_{t+1}^{np}, y_{t+1}^p)} \right]^{\frac{1}{2}} \\ &= [\Delta\mathcal{SE}_t^{ip} \times \Delta\mathcal{SE}_{t+1}^{ip}]^{\frac{1}{2}}.\end{aligned}\tag{4.25}$$

If  $\Delta\mathcal{EDS}_{t,t+1} = 1$  then the observation performs at the optimal scale in the input dimension. However, when  $\Delta\mathcal{EDS}_{t,t+1} \neq 1$  then there exists some scale adaptations that generate productivity change.

Various cases of environmental disaggregated scale efficiency change in the input direction can appear and they are underscored in Appendix 3 (Table 2).

## 4.2 Environmental disaggregated Luenberger-Hicks-Moorsten productivity indicator

The environmental disaggregated Luenberger-Hicks-Moorsten productivity measure is a particular additive complete index (O'Donnell, 2012). The aggregator functions of polluting and no polluting components are additive distance functions. Following Ang and Kerstens (2017), a decomposition of the environmental disaggregated Luenberger-Hicks-Moorsten productivity measure is defined in the next result.

**Definition 4.2** *Let  $T_t$  be a production technology that satisfies properties T1 – T3 and T5. For any  $(x_t, y_t) \in \mathbb{R}_+^{n+m}$ , where  $x_t = (x_t^p, x_t^{np}) \in \mathbb{R}_+^n$  and  $y_t = (y_t^p, y_t^{np}) \in \mathbb{R}_+^m$ , the global environmental disaggregated Luenberger-Hicks-Moorsten productivity measure between periods  $(t, t + 1)$  is decomposed as follows:*

$$\begin{aligned} EDLHM_{t,t+1} &= \Delta EDT_{t,t+1} + \Delta EDE_{t,t+1} + \Delta EDS_{t,t+1} \\ &= \Delta \mathcal{E}DT_{t,t+1} + \Delta \mathcal{E}DE_{t,t+1} + \Delta \mathcal{E}DS_{t,t+1}. \end{aligned} \quad (4.26)$$

Such that,

- i.  $\Delta EDT_{t,t+1}$  ( $\Delta \mathcal{E}DT_{t,t+1}$ ) is the environmental disaggregated technical change in the output (input) direction between periods  $(t, t + 1)$ .
- ii.  $\Delta EDE_{t,t+1}$  ( $\Delta \mathcal{E}DE_{t,t+1}$ ) denotes the environmental disaggregated efficiency variation in the output (input) direction over periods  $(t, t + 1)$ .
- iii.  $\Delta EDS_{t,t+1}$  ( $\Delta \mathcal{E}DS_{t,t+1}$ ) is the environmental disaggregated scale efficiency change in the output (input) direction between periods  $(t, t + 1)$ .

### 4.2.1 Decomposition in output direction

The environmental disaggregated technical change in the output direction over periods  $(t, t + 1)$  is defined below (Figure 10):

$$\Delta EDT_{t,t+1} = \Delta T_{t,t+1}^{o^{np}} + \Delta T_{t,t+1}^{o^p}. \quad (4.27)$$

Where,

$$\begin{aligned} \Delta T_{t,t+1}^{o^{np}} &= \frac{1}{2} \left[ (\Xi_{t+1}^{o^{np}}(x_t, y_t) - \Xi_t^{o^{np}}(x_t, y_t)) + \right. \\ &\quad \left. (\Xi_{t+1}^{o^{np}}(x_{t+1}, y_{t+1}) - \Xi_t^{o^{np}}(x_{t+1}, y_{t+1})) \right] \end{aligned} \quad (4.28)$$

and

$$\Delta T_{t,t+1}^{op} = \frac{1}{2} \left[ (\Xi_{t+1}^{op}(x_t, y_t) - \Xi_t^{op}(x_t, y_t)) + (\Xi_{t+1}^{op}(x_{t+1}, y_{t+1}) - \Xi_t^{op}(x_{t+1}, y_{t+1})) \right] \quad (4.29)$$

are respectively no polluting and polluting technical change in the output direction between periods  $(t, t+1)$ .

When  $\Delta T_{t,t+1}^{onp} > 0$  then, no polluting technological improvement occurs in the output direction over periods  $(t, t+1)$ . Moreover, if  $\Delta T_{t,t+1}^{op} > 0$  it follows that polluting technological progress arises in the output dimension between period  $(t)$  and period  $(t+1)$ . In such a case,  $\Delta EDT_{t,t+1} > 0$  and environmental disaggregated technological advance appears in the output direction between periods  $(t)$  and  $(t+1)$ .

Several cases of environmental disaggregated technological change in the output direction can occur and they are displayed in Appendix 3 (Table 3).

The environmental disaggregated efficiency change in the output direction over periods  $(t, t+1)$  is defined as follows (Figure 12),

$$\Delta EDE_{t,t+1} = \Delta EC_{t,t+1}^{onp} + \Delta EC_{t,t+1}^{op}. \quad (4.30)$$

Such that,

$$\Delta EC_{t,t+1}^{onp} = \Xi_t^{onp}(x_t, y_t) - \Xi_{t+1}^{onp}(x_{t+1}, y_{t+1}) \quad (4.31)$$

and

$$\Delta EC_{t,t+1}^{op} = \Xi_t^{op}(x_t, y_t) - \Xi_{t+1}^{op}(x_{t+1}, y_{t+1}) \quad (4.32)$$

are respectively no polluting and polluting efficiency variation in the output direction between periods  $(t)$  and  $(t+1)$ .

Remark that if  $\Delta EC_{t,t+1}^{onp} > 0$  then, no polluting output efficiency advance arises between periods  $(t, t+1)$ . In addition, when  $\Delta EC_{t,t+1}^{op} > 0$  then polluting efficiency improvement occur over periods  $(t)$  and  $(t+1)$ . It follows that,  $\Delta EDE_{t,t+1} > 0$  and environmental disaggregated efficiency progress appears in the output direction over periods  $(t, t+1)$ .

Various cases of environmental disaggregated efficiency change in the output direction can appear and they are exposed in Appendix 3 (Table 3).

Since the EDLHM is composed by the technology change, the efficiency variation and the scale efficiency change then, this latter can be provided by the following residual:

$$\Delta EDS_{t,t+1} = EDLHM_{t,t+1} - \Delta EDT_{t,t+1} - \Delta EDE_{t,t+1}, \quad (4.33)$$

where  $\Delta EDS_{t,t+1}$  is the scale efficiency change in output direction between periods  $(t)$  and

$(t + 1)$ .

Denote that when there is no efficiency variation ( $\Delta EDE_{t,t+1} = 0$ ) and no technical change ( $\Delta EDT_{t,t+1} = 0$ ) then the gain or loss of productivity is the result of environmental scale efficiency change ( $EDLHM_{t,t+1} = \Delta EDS_{t,t+1}$ ). In such a case, the technology does not move and the production unit is technically efficient (on the boundary of the technology). Thus, the productivity change is solely provided by the movement of the production unit along the production frontier.

Remark that the output scale efficiency change is defined from no polluting and polluting standpoint such that:

$$\Delta EDS_{t,t+1} = \Delta SE_{t,t+1}^{o^{np}} + \Delta SE_{t,t+1}^{o^p}. \quad (4.34)$$

Where, from the residual, we have:

$$\begin{aligned} \Delta SE_{t,t+1}^{o^{np}} = & \frac{1}{2} \left[ \left( \Xi_t^{o^{np}}(x_{t+1}, y_{t+1}) - \Xi_t^{o^{np}}(x_t^{np}, x_t^p, y_{t+1}^{np}, y_t^p) \right) \right. \\ & \left. + \left( \Xi_{t+1}^{o^{np}}(x_{t+1}^{np}, x_{t+1}^p, y_t^{np}, y_{t+1}^p) - \Xi_{t+1}^{o^{np}}(x_t, y_t) \right) \right] \\ & - \frac{1}{2} \left[ \left( \Xi_t^{i^{np}}(x_{t+1}^{np}, x_t^p, y_t^{np}, y_t^p) - \Xi_t^{i^{np}}(x_t, y_t) \right) \right. \\ & \left. + \left( \Xi_{t+1}^{i^{np}}(x_{t+1}, y_{t+1}) - \Xi_{t+1}^{i^{np}}(x_t^{np}, x_{t+1}^p, y_{t+1}^{np}, y_{t+1}^p) \right) \right], \quad (4.35) \end{aligned}$$

and

$$\begin{aligned} \Delta SE_{t,t+1}^{o^p} = & \frac{1}{2} \left[ \left( \Xi_t^{o^p}(x_{t+1}, y_{t+1}) - \Xi_t^{o^p}(x_t^{np}, x_t^p, y_t^{np}, y_{t+1}^p) \right) \right. \\ & \left. + \left( \Xi_{t+1}^{o^p}(x_{t+1}^{np}, x_{t+1}^p, y_{t+1}^{np}, y_t^p) - \Xi_{t+1}^{o^p}(x_t, y_t) \right) \right] \\ & - \frac{1}{2} \left[ \left( \Xi_t^{i^p}(x_t^{np}, x_{t+1}^p, y_t^{np}, y_t^p) - \Xi_t^{i^p}(x_t, y_t) \right) \right. \\ & \left. + \left( \Xi_{t+1}^{i^p}(x_{t+1}, y_{t+1}) - \Xi_{t+1}^{i^p}(x_{t+1}^{np}, x_t^p, y_{t+1}^{np}, y_{t+1}^p) \right) \right]. \quad (4.36) \end{aligned}$$

The distillation of the above results allows to distinguish the scale efficiency change separately provided by the input and the output components. Hence, let us first define the following no polluting outputs projections:

$$\bar{y}_t^{np} = y_t^{np} + \Xi_t^{o^{np}}(x_t, y_t) \cdot y_t^{np},$$

$$\bar{y}_{t+1}^{np} = y_{t+1}^{np} + \Xi_{t+1}^{o^{np}}(x_{t+1}, y_{t+1}) \cdot y_{t+1}^{np},$$

$$\hat{y}_t^{np} = y_t^{np} + \Xi_{t+1}^{o^{np}}(x_t, y_t) \cdot y_t^{np},$$

$$\hat{y}_{t+1}^{np} = y_{t+1}^{np} + \Xi_t^{o^{np}}(x_{t+1}, y_{t+1}) \cdot y_{t+1}^{np}.$$

The addition and the subtraction of respectively  $\Xi_t^{o^{np}}(x_t, y_t)$  and  $\Xi_{t+1}^{o^{np}}(x_{t+1}, y_{t+1})$  allow to express the no polluting output scale efficiency change as follows (Figure 14):

$$\begin{aligned} \Delta SE_{t,t+1}^{o^{np}} &= \frac{1}{2} \left[ \left( \Xi_t^{o^{np}}(x_t^{np}, x_t^p, \bar{y}_t^{np}, y_t^p) - \Xi_t^{o^{np}}(x_t^{np}, x_t^p, \hat{y}_{t+1}^{np}, y_t^p) \right) \right. \\ &\quad - \left( \Xi_t^{i^{np}}(x_{t+1}^{np}, x_t^p, y_t^{np}, y_t^p) - \Xi_t^{i^{np}}(x_t, y_t) \right) \\ &\quad + \left( \Xi_{t+1}^{o^{np}}(x_{t+1}^{np}, x_{t+1}^p, \hat{y}_t^{np}, y_{t+1}^p) - \Xi_{t+1}^{o^{np}}(x_{t+1}^{np}, x_{t+1}^p, \bar{y}_{t+1}^{np}, y_{t+1}^p) \right) \\ &\quad \left. - \left( \Xi_{t+1}^{i^{np}}(x_{t+1}, y_{t+1}) - \Xi_{t+1}^{i^{np}}(x_t^{np}, x_{t+1}^p, y_{t+1}^{np}, y_{t+1}^p) \right) \right] \\ &= \frac{1}{2} [\Delta SE_t^{o^{np}} + \Delta SE_{t+1}^{o^{np}}]. \end{aligned} \tag{4.37}$$

We can also distil the polluting output scale efficiency change. To do so, let us present the polluting outputs projections as follows:

$$\bar{y}_t^p = y_t^p - \Xi_t^{o^p}(x_t, y_t) \cdot y_t^p,$$

$$\bar{y}_{t+1}^p = y_{t+1}^p - \Xi_{t+1}^{o^p}(x_{t+1}, y_{t+1}) \cdot y_{t+1}^p,$$

$$\hat{y}_t^p = y_t^p + \Xi_{t+1}^{o^p}(x_t, y_t) \cdot y_t^p,$$

$$\hat{y}_{t+1}^p = y_{t+1}^p + \Xi_t^{o^p}(x_{t+1}, y_{t+1}) \cdot y_{t+1}^p.$$

Thus, adding and subtracting respectively  $\Xi_t^{o^p}(x_t, y_t)$  and  $\Xi_{t+1}^{o^p}(x_{t+1}, y_{t+1})$  yield the fol-

lowing polluting output scale efficiency variation (Figure 14):

$$\begin{aligned}
\Delta SE_{t,t+1}^{op} &= \frac{1}{2} \left[ \left( \Xi_t^{op}(x_t^{np}, x_t^p, y_t^{np}, \bar{y}_t^p) - \Xi_t^{op}(x_t^{np}, x_t^p, y_t^{np}, \hat{y}_{t+1}^p) \right) \right. \\
&\quad - \left( \Xi_t^{ip}(x_t^{np}, x_{t+1}^p, y_t^{np}, y_t^p) - \Xi_t^{ip}(x_t, y_t) \right) \\
&\quad + \left( \Xi_{t+1}^{op}(x_{t+1}^{np}, x_{t+1}^p, y_{t+1}^{np}, \hat{y}_t^p) - \Xi_{t+1}^{op}(x_{t+1}^{np}, x_{t+1}^p, y_{t+1}^{np}, \hat{y}_{t+1}^p) \right) \\
&\quad \left. - \left( \Xi_{t+1}^{ip}(x_{t+1}, y_{t+1}) - \Xi_{t+1}^{ip}(x_{t+1}^{np}, x_t^p, y_{t+1}^{np}, y_{t+1}^p) \right) \right] \\
&= \frac{1}{2} [\Delta SE_t^{op} + \Delta SE_{t+1}^{op}]. \tag{4.38}
\end{aligned}$$

Notice that when  $\Delta EDS_{t,t+1} = 0$  then the production unit performs at the optimal scale in the output direction. Besides, if  $\Delta EDS_{t,t+1} \neq 0$  then there exist some scale alterations that lead to productivity variation; see Appendix 3 (Table 3).

#### 4.2.2 Decomposition in input direction

In the input direction, the environmental disaggregated technical change between periods  $(t, t + 1)$  is defined as follows (Figure 9),

$$\Delta \mathcal{EDT}_{t,t+1} = \Delta \mathcal{T}_{t,t+1}^{inp} + \Delta \mathcal{T}_{t,t+1}^{ip}. \tag{4.39}$$

Such that,

$$\begin{aligned}
\Delta \mathcal{T}_{t,t+1}^{inp} &= \frac{1}{2} \left[ \left( \Xi_{t+1}^{inp}(x_t, y_t) - \Xi_t^{inp}(x_t, y_t) \right) + \right. \\
&\quad \left. \left( \Xi_{t+1}^{inp}(x_{t+1}, y_{t+1}) - \Xi_t^{inp}(x_{t+1}, y_{t+1}) \right) \right] \tag{4.40}
\end{aligned}$$

and

$$\begin{aligned}
\Delta \mathcal{T}_{t,t+1}^{ip} &= \frac{1}{2} \left[ \left( \Xi_{t+1}^{ip}(x_t, y_t) - \Xi_t^{ip}(x_t, y_t) \right) + \right. \\
&\quad \left. \left( \Xi_{t+1}^{ip}(x_{t+1}, y_{t+1}) - \Xi_t^{ip}(x_{t+1}, y_{t+1}) \right) \right] \tag{4.41}
\end{aligned}$$

show no polluting and polluting input technical change over periods  $(t, t + 1)$ .

If  $\Delta \mathcal{T}_{t,t+1}^{inp} > 0$  (respectively  $\Delta \mathcal{T}_{t,t+1}^{ip} > 0$ ) then, no polluting (respectively polluting) technological improvement arises in the input direction between periods  $(t, t + 1)$ . In such a case,  $\Delta \mathcal{EDT}_{t,t+1} > 0$  and input environmental disaggregated technological improvement occurs between periods  $(t, t + 1)$ . Several cases of environmental disaggregated technological change in the input direction can arise and they are displayed in Appendix 3 (Table 4).

In the same vein, the input environmental disaggregated efficiency change between periods  $(t, t + 1)$  is defined below (Figure 11),

$$\Delta\mathcal{E}\mathcal{D}\mathcal{E}_{t,t+1} = \Delta\mathcal{E}\mathcal{C}_{t,t+1}^{inp} + \Delta\mathcal{E}\mathcal{C}_{t,t+1}^{ip}. \quad (4.42)$$

Such that,

$$\Delta\mathcal{E}\mathcal{C}_{t,t+1}^{inp} = \Xi_t^{inp}(x_t, y_t) - \Xi_{t+1}^{inp}(x_{t+1}, y_{t+1}) \quad (4.43)$$

and

$$\Delta\mathcal{E}\mathcal{C}_{t,t+1}^{ip} = \Xi_t^{ip}(x_t, y_t) - \Xi_{t+1}^{ip}(x_{t+1}, y_{t+1}) \quad (4.44)$$

are respectively no polluting and polluting input efficiency variation over periods  $(t)$  and  $(t + 1)$ .

If  $\Delta\mathcal{E}\mathcal{C}_{t,t+1}^{inp} > 0$  (respectively  $\Delta\mathcal{E}\mathcal{C}_{t,t+1}^{ip} > 0$ ) then, no polluting (respectively polluting) efficiency advance arises in the input direction over periods  $(t, t + 1)$ . It follows that,  $\Delta\mathcal{E}\mathcal{D}\mathcal{E}_{t,t+1} > 0$  and input environmental disaggregated efficiency progress occurs between periods  $(t, t + 1)$ . Various cases of environmental disaggregated efficiency change in the input direction can appear and they are underscored in Appendix 3 (Table 4).

Since the EDLHM is the sum of the technology change, the efficiency variation and the scale efficiency change then, this latter is the result of the following residual:

$$\Delta\mathcal{E}\mathcal{D}\mathcal{S}_{t,t+1} = EDLHM_{t,t+1} - \Delta\mathcal{E}\mathcal{D}\mathcal{T}_{t,t+1} - \Delta\mathcal{E}\mathcal{D}\mathcal{E}_{t,t+1}. \quad (4.45)$$

Note that  $\Delta\mathcal{E}\mathcal{D}\mathcal{S}_{t,t+1}$  is the scale efficiency change in input direction between periods  $(t)$  and  $(t + 1)$ .

When there is no efficiency variation ( $\Delta\mathcal{E}\mathcal{D}\mathcal{E}_{t,t+1} = 0$ ) and no technical change arises ( $\Delta\mathcal{E}\mathcal{D}\mathcal{T}_{t,t+1} = 0$ ) then the productivity change results from the environmental scale efficiency variation ( $EDLHM_{t,t+1} = \Delta\mathcal{E}\mathcal{D}\mathcal{S}_{t,t+1}$ ). Consequently, the productivity change is the consequence of the movement of the production unit along the efficient production frontier.

As for the case of output scale efficiency, we can define the input scale efficiency change between periods  $(t)$  and  $(t + 1)$ . It is provided by the no polluting and the polluting input scale efficiency change as follows:

$$\Delta\mathcal{E}\mathcal{D}\mathcal{S}_{t,t+1} = \Delta\mathcal{S}\mathcal{E}_{t,t+1}^{inp} + \Delta\mathcal{S}\mathcal{E}_{t,t+1}^{ip}. \quad (4.46)$$

From the residual we have:

$$\begin{aligned}
\Delta \mathcal{S} \mathcal{E}_{t,t+1}^{inp} = & \frac{1}{2} \left[ \left( \Xi_t^{o^{np}}(x_t, y_t) - \Xi_t^{o^{np}}(x_t^{np}, x_t^p, y_{t+1}^{np}, y_t^p) \right) \right. \\
& + \left. \left( \Xi_{t+1}^{o^{np}}(x_{t+1}^{np}, x_{t+1}^p, y_t^{np}, y_{t+1}^p) - \Xi_{t+1}^{o^{np}}(x_{t+1}, y_{t+1}) \right) \right] \\
& - \frac{1}{2} \left[ \left( \Xi_t^{i^{np}}(x_{t+1}^{np}, x_t^p, y_t^{np}, y_t^p) - \Xi_t^{i^{np}}(x_{t+1}, y_{t+1}) \right) \right. \\
& + \left. \left( \Xi_{t+1}^{i^{np}}(x_t, y_t) - \Xi_{t+1}^{i^{np}}(x_t^{np}, x_{t+1}^p, y_{t+1}^{np}, y_{t+1}^p) \right) \right], \tag{4.47}
\end{aligned}$$

and

$$\begin{aligned}
\Delta \mathcal{S} \mathcal{E}_{t,t+1}^{ip} = & \frac{1}{2} \left[ \left( \Xi_t^{o^p}(x_t, y_t) - \Xi_t^{o^p}(x_t^{np}, x_t^p, y_t^{np}, y_{t+1}^p) \right) \right. \\
& + \left. \left( \Xi_{t+1}^{o^p}(x_{t+1}^{np}, x_{t+1}^p, y_{t+1}^{np}, y_t^p) - \Xi_{t+1}^{o^p}(x_{t+1}, y_{t+1}) \right) \right] \\
& - \frac{1}{2} \left[ \left( \Xi_t^{i^p}(x_t^{np}, x_{t+1}^p, y_t^{np}, y_t^p) - \Xi_t^{i^p}(x_{t+1}, y_{t+1}) \right) \right. \\
& + \left. \left( \Xi_{t+1}^{i^p}(x_t, y_t) - \Xi_{t+1}^{i^p}(x_{t+1}^{np}, x_t^p, y_{t+1}^{np}, y_{t+1}^p) \right) \right]. \tag{4.48}
\end{aligned}$$

The distillation of these residuals allows to separate scale efficiency variation provided by input and output components. In such a case, let us introduce the no polluting inputs projections as follows:

$$\bar{x}_t^{np} = x_t^{np} - \Xi_t^{i^{np}}(x_t, y_t) \cdot x_t^{np},$$

$$\bar{x}_{t+1}^{np} = x_{t+1}^{np} - \Xi_{t+1}^{i^{np}}(x_{t+1}, y_{t+1}) \cdot x_{t+1}^{np},$$

$$\hat{x}_t^{np} = x_t^{np} - \Xi_{t+1}^{i^{np}}(x_t, y_t) \cdot x_t^{np},$$

$$\hat{x}_{t+1}^{np} = x_{t+1}^{np} - \Xi_t^{i^{np}}(x_{t+1}, y_{t+1}) \cdot x_{t+1}^{np}.$$

Hence, the addition and subtraction of respectively  $\Xi_t^{i^{np}}(x_t, y_t)$  and  $\Xi_{t+1}^{i^{np}}(x_{t+1}, y_{t+1})$  provide the following result in no polluting input direction (Figure 13):



$$\begin{aligned}
\Delta \mathcal{SE}_{t,t+1}^{inp} &= \frac{1}{2} \left[ \left( \Xi_t^{o^{np}}(x_t, y_t) - \Xi_t^{o^{np}}(x_t^{np}, x_t^p, y_{t+1}^{np}, y_t^p) \right) \right. \\
&\quad - \left( \Xi_t^{i^{np}}(\hat{x}_{t+1}^{np}, x_t^p, y_t^{np}, y_t^p) - \Xi_t^{i^{np}}(\bar{x}_t^{np}, x_t^p, y_t^{np}, y_t^p) \right) \\
&\quad + \left( \Xi_{t+1}^{o^{np}}(x_{t+1}^{np}, x_{t+1}^p, y_{t+1}^{np}, y_{t+1}^p) - \Xi_{t+1}^{o^{np}}(x_{t+1}, y_{t+1}) \right) \\
&\quad \left. - \left( \Xi_{t+1}^{i^{np}}(\bar{x}_{t+1}^{np}, x_{t+1}^p, y_{t+1}^{np}, y_{t+1}^p) - \Xi_{t+1}^{i^{np}}(\hat{x}_t^{np}, x_{t+1}^p, y_{t+1}^{np}, y_{t+1}^p) \right) \right] \\
&= \frac{1}{2} [\Delta \mathcal{SE}_t^{inp} + \Delta \mathcal{SE}_{t+1}^{inp}]. \tag{4.49}
\end{aligned}$$

As for the case of no polluting inputs, we can also give a distilled definition of the residual. To do that, assume the polluting inputs projections below:

$$\begin{aligned}
\bar{x}_t^p &= x_t^p - \Xi_t^{ip}(x_t, y_t) \cdot x_t^p, \\
\bar{x}_{t+1}^p &= x_{t+1}^p - \Xi_{t+1}^{ip}(x_{t+1}, y_{t+1}) \cdot x_{t+1}^p, \\
\hat{x}_t^p &= x_t^p - \Xi_{t+1}^{ip}(x_t, y_t) \cdot x_t^p, \\
\hat{x}_{t+1}^p &= x_{t+1}^p - \Xi_t^{ip}(x_{t+1}, y_{t+1}) \cdot x_{t+1}^p.
\end{aligned}$$

Here again, adding and subtracting respectively  $\Xi_t^{ip}(x_t, y_t)$  and  $\Xi_{t+1}^{ip}(x_{t+1}, y_{t+1})$  allow to define the scale efficiency variation in polluting input dimension as follows (Figure 13):

$$\begin{aligned}
\Delta \mathcal{SE}_{t,t+1}^{ip} &= \frac{1}{2} \left[ \left( \Xi_t^{o^p}(x_t, y_t) - \Xi_t^{o^p}(x_t^{np}, x_t^p, y_t^{np}, y_{t+1}^p) \right) \right. \\
&\quad - \left( \Xi_t^{ip}(x_t^{np}, \hat{x}_{t+1}^p, y_t^{np}, y_t^p) - \Xi_t^{ip}(x_t^{np}, \bar{x}_t^p, y_t^{np}, y_t^p) \right) \\
&\quad + \left( \Xi_{t+1}^{o^p}(x_{t+1}^{np}, x_{t+1}^p, y_{t+1}^{np}, y_t^p) - \Xi_{t+1}^{o^p}(x_{t+1}, y_{t+1}) \right) \\
&\quad \left. - \left( \Xi_{t+1}^{ip}(x_{t+1}^{np}, \bar{x}_{t+1}^p, y_{t+1}^{np}, y_{t+1}^p) - \Xi_{t+1}^{ip}(x_{t+1}^{np}, \hat{x}_t^p, y_{t+1}^{np}, y_{t+1}^p) \right) \right] \\
&= \frac{1}{2} [\Delta \mathcal{SE}_t^{ip} + \Delta \mathcal{SE}_{t+1}^{ip}]. \tag{4.50}
\end{aligned}$$

If  $\Delta \mathcal{EDS}_{t,t+1} = 0$  then the observation operates at the optimal scale in the input direction. Nevertheless, if  $\Delta \mathcal{EDS}_{t,t+1} \neq 0$  then the production unit adopted some scale adjustment that allows productivity change between  $(t)$  and  $(t+1)$ ; see Appendix 3 (Table 4).

**FIGURES 9-14 ABOUT HERE**

## Conclusion

The main contribution of this paper is the definition of environmental disaggregated ratio- and difference-based productivity measures. Indeed, both input and output vectors are separated into polluting and no polluting components. Hence, the impacts of input and output quality change on environmental productivity variation can be analysed.

Environmental disaggregated Hicks-Moorsteen and Luenberger-Hicks-Moorsteen productivity measures take the form of multiplicative and additive complete TFP indicators. Therefore, a decomposition of the new ratio- and difference-based environmental disaggregated TFP measures in input and output directions is proposed. Moreover, the convexity assumption of the environmental production process is not required to analyse these new TFP indices.

Appreciating environmental disaggregated components of environmental TFP change is a major concern in business, policy-relevant or academic contexts to define environmental recommendations. Decomposition and disaggregation analysis of TFP variation display complementary informations. Indeed, the main sources of polluting and no polluting environmental TFP change are underscored through input and output directions.

## References

- [1] Abad, A. (2015) An environmental generalised Luenberger-Hicks-Moorsteen productivity indicator and an environmental generalised Hicks-Moorsteen productivity index, *Journal of Environmental Management*, 161, 325-334.
- [2] Abad, A. (2018) *Les Enseignements de la Micro-économie de la Production face aux Enjeux Environnementaux: Etude des Productions Jointes. Théorie et Applications*, Ph.D dissertation, University of Perpignan.
- [3] Abad, A., W. Brieç (2019) On the Axiomatic of Pollution-generating Technologies: a Non-Parametric Approach, *European Journal of Operational Research*, 277(1), 377-390.
- [4] Aiken, D.V., C.A. Pasurka (2003) Adjusting the measurement of US manufacturing productivity for air pollution emissions control, *Resource and Energy Economics* , 25, 329-351.
- [5] Ang, F., P.J. Kerstens (2017) Decomposing the Luenberger-Hicks-Moorsteen Total Factor Productivity indicator: An application to U.S. agriculture, *European Journal of Operational Research*, 260, 359-370.
- [6] Azad, Md.A.S., T. Ancev (2014) Measuring environmental efficiency of agricultural water use: A Luenberger environmental indicator, *Journal of Environmental Management*, 145, 314-320.
- [7] Bjurek, H. (1996) The Malmquist Total Factor Productivity Index, *Scandinavian Journal of Economics*, 98, 303-313.
- [8] Bjurek, H., F.R. Førsund, L. Hjalmarsson (1998) Malmquist Productivity Indices: An Empirical Investigation, dans : R. Färe, S. Grosskopf, R. Russell (eds) *Index Numbers: Essays in Honour of Sten Malmquist*, Boston, Kluwer.
- [9] Boussemart, J.P., W. Brieç, K. Kerstens, J.-C. Poutineau (2003) Luenberger and Malmquist Productivity Indices: Theoretical Comparisons and Empirical Illustration, *Bulletin of Economic Research*, 55(4), 391-405.
- [10] Boyd, G. A., J. D. McCelland (1999) The Impact of Environmental Constraints on Productivity Improvement in Integrated Paper Plants, *Journal of Environmental Economics and Management*, 38, 121-142.
- [11] Brieç, W., (1997) A Graph-Type Extension of Farrell Technical Efficiency Measure, *Journal of Productivity Analysis*, 8(1), 95-110.
- [12] Brieç, W., K. Kerstens (2004) A Luenberger-Hicks-Moorsteen Productivity Indicator: Its Relation to the Hicks-Moorsteen Productivity Index and the Luenberger Productivity Indicator, *Economic Theory*, 23(4), 925-939.

- [13] Caves, D.W., L.R. Christensen, W.E. Diewert (1982) The Economic Theory of Index Numbers and the Measurement of Inputs, Outputs and Productivity, *Econometrica*, 50, 1393-1414.
- [14] Chambers, R., Chung, Y., R. Färe (1996) Benefit and Distance Functions, *Journal of Economic Theory*, 70(2), 407-419.
- [15] Chambers, R.G. (2002) Exact Nonradial Input, Output, and Productivity Measurement, *Economic Theory*, 20, 751-765.
- [16] Chavas, J-P., W. Briec (2012) On economic efficiency under non-convexity, *Economic Theory*, 50, 671-701.
- [17] Chavas, J-P., W. Briec (2018) Efficiency under Uncertainty and Non-convexity: Evaluating the Role of Probabilities, *Economica*, 86(344), 832-853.
- [18] Coelli, T., Lauwers, L., G. Van Huylenbroeck (2007) Environmental efficiency measurement and the materials balance condition *Journal of Productivity Analysis*, 28, 3-12.
- [19] Chung, Y.H., Färe, R., S. Grosskopf (1997) Productivity and undesirable outputs: A directional distance function approach, *Journal of Environmental Management*, 51, 229-240.
- [20] Dasgupta, P., K.G. Mäler (2003) The Economics of Non-Convex Ecosystems: Introduction, *Environmental and Resource Economics*, 26(4), 499-525.
- [21] De Borger, K. Kerstens (1996) Cost efficiency of Belgian Local Governments: A comparative analysis of FDH, DEA and econometric approaches, *Regional Science and Urban Economics*, 26, 145-170.
- [22] Debreu, G. (1951) The coefficient of resource utilisation, *Econometrica*, 19, 273-292.
- [23] Diewert, W. E., K. J. Fox (2017) Decomposing productivity indexes into explanatory factors, *European Journal of Operational Research*, 256, 275-291.
- [24] Färe, R., Grosskopf, S., C.A.K. Lovell (1985) *Hyperbolic Graph Efficiency Measures*, in: The Measurement of Efficiency of Production, Springer, Dordrecht, 107-130.
- [25] Färe, R., Grosskopf, S., Lovell, C.A.K., C. Pasurka (1989) Multilateral productivity comparisons when some outputs are undesirable: A non parametric approach, *The Review of Economics and Statistics*, 71, 90-98.
- [26] Färe, R., Grosskopf, S., Norris, M., Z. Zhang (1994) Productivity growth, technical progress, and efficiency change in industrialized countries, *The American Economic Review*, 84, 66-83.

- [27] Färe, R., Grosskopf, S., F. Hernandez-Sancho (2004) Environmental performance: an index number approach, *Resource and Energy Economics*, 26, 343-352.
- [28] Färe, R., Grosskopf, S., Lundgren, T., Marklund, P-O., W. Zhou (2012) Productivity: Should We Include Bads? *CERE Working Paper*, 2012:13.
- [29] Farrell, M.J. (1957) The measurement of technical efficiency, *Journal of the Royal Statistical Society*, 120(3), 253-290.
- [30] Førsund, F. R. (2009) Good Modeling of Bad Outputs: Pollution and Multiple-Output Production, *International Review of Environmental and Resource Economics*, 3, 1-38.
- [31] Førsund, F. R. (2016) Multi-Equation Modelling of Desirable and Undesirable Outputs Satisfying the Material Balance, *Department of Economics, University of Oslo*, Memorandum N<sub>0</sub> 3.
- [32] Grifell-Tatjé, E., K. Kerstens (2008) Incentive Regulation And The Role Of Convexity In Benchmarking Electricity Distribution: Economists Versus Engineers, *Annals of Public and Cooperative Economics*, 79(2), 227-248.
- [33] Hailu, A., T. S. Veeman (2000) Environmentally Sensitive Productivity Analysis of the Canadian Pulp and Paper Industry, 1959-1994: An Input Distance Function Approach, *Journal of Environmental Economics and Management*, 40, 251-274.
- [34] Hoang, V-N., T. Coelli (2011) Measurement of agricultural total factor productivity growth incorporating environmental factors: A nutrients balance approach, *Journal of Environmental Economics and Management*, 62(3), 462-474.
- [35] Kerstens, K. , I. Van de Woestyne (2014) Comparing Malmquist and Hicks-Moorsteen productivity indices: Exploring the impact of unbalanced vs. balanced panel data *European Journal of Operational Research*, 233, 749-758.
- [36] Kumar, S. (2006) Environmentally sensitive productivity growth: A global analysis using MalmquistLuenberger index, *Ecological Economics*, 56(2), 280-293.
- [37] Lauwers, L., G. Van Huylenbroeck (2003) Materials balance based modelling of environmental efficiency. In 25th international conference of agricultural economist, South Africa.
- [38] Lauwers, L. (2009) Justifying the incorporation of the materials balance principle into frontier-based eco-efficiency models, *Ecological Economics*, 68, 1605-1614
- [39] Managi, S. (2010) Productivity measures and effects from subsidies and trade: an empirical analysis for Japan's forestry, *Applied Economics*, 42(30), 3871-3883.

- [40] Miao, Z., Chen, X., Balezentis, T., C. Sun (2019) Atmospheric environmental productivity across the provinces of China: Joint decomposition of range adjusted measure and Luenberger productivity indicator, *Energy Policy*, 132, 665-677.
- [41] Murty, S. , R. R. Russell, S. B. Levkoff (2012) On Modeling Pollution-Generating Technologies, *Journal of Environmental Economics and Management*, 64, 117-135.
- [42] Nakano, M. , S. Managi (2008) Regulatory reforms and productivity: An empirical analysis of the Japanese electricity industry, *Energy Policy*, 36(1), 201-209.
- [43] O'Donnell, C.J (2012) An Aggregate Quantity-Price Framework for Measuring and Decomposing Productivity and Profitability Change, *Journal of Productivity Analysis*, 38(3), 255-272.
- [44] Oh, D., A. Heshmati (2010) A sequential MalmquistLuenberger productivity index: Environmentally sensitive productivity growth considering the progressive nature of technology, *Energy Economics*, 32(6), 1345-1355.
- [45] Picazo-Tadeo, A.J., J. Castillo-Giménez, M. Beltrán-Esteve (2014) An intertemporal approach to measuring environmental performance with directional distance functions: Greenhouse gas emissions in the European Union, *Ecological Economics* , 100, 173-182.
- [46] Pittman, R.W. (1983) Multilateral Productivity Comparisons With Undesirable Outputs, *The Economic Journal* , 93, 883-891.
- [47] Rødseth, K. L. (2017) Axioms of a Polluting Technology: A Materials Balance Approach, *Environmental and Resources Economics*, 67(1), 1-22.
- [48] Shen, Z., Boussemart, J-P., H. Leleu (2017) Aggregate green productivity growth in OECD's countries, *International Journal of Production Economics*, 189, 30-39.
- [49] Shephard, R.W. (1970) *Theory of Cost and Production Functions*, Princeton: Princeton University Press.
- [50] Solow, R. (1957) Technical Change and the Aggregate Production Function, *The Review of Economics and Statistics*, 39,312-320.
- [51] Tschirhart, J. (2012) Biology as a Source of Non-convexities in Ecological Production Functions, *Environmental and Resource Economics*, 51(2), 189-213.
- [52] Tyteca, D. (1996) On the Measurement of the Environmental Performance of Firms - a Literature Review and a Productive Efficiency Perspective, *Journal of Environmental Management*,46, 281-308.

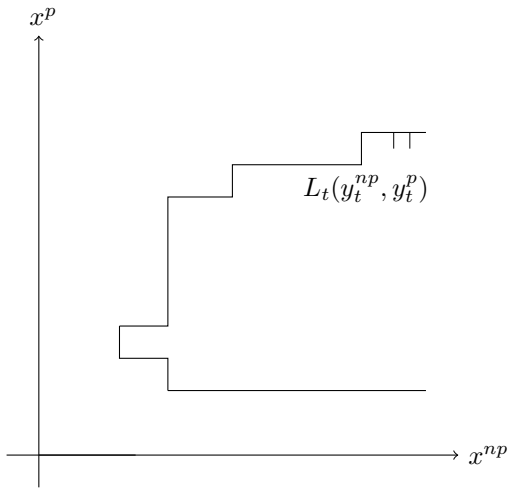

Figure 1: Non convex input set

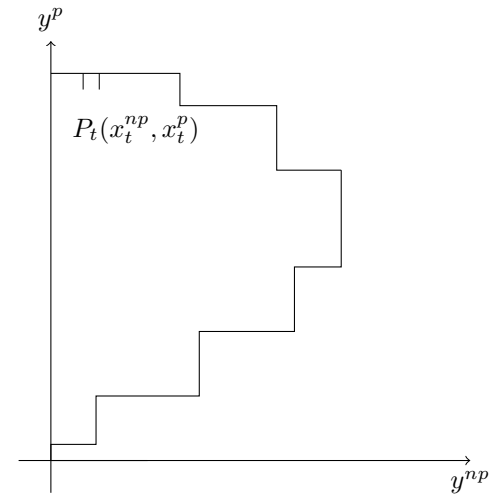

Figure 2: Non convex output set

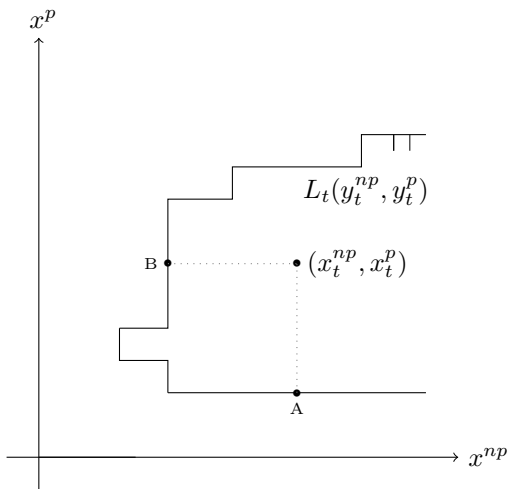

Figure 3: Input sub-vector polluting and no polluting multiplicative distance functions

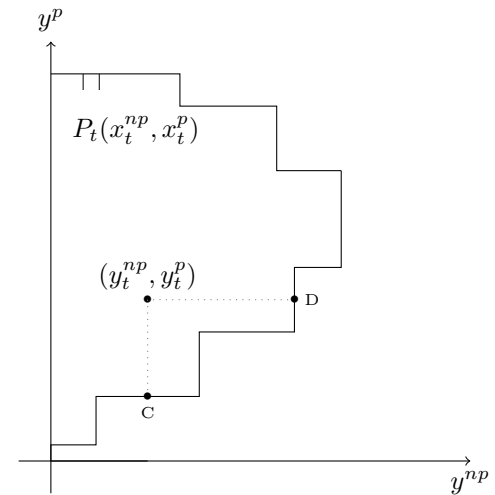

Figure 4: Output sub-vector polluting and no polluting multiplicative distance functions

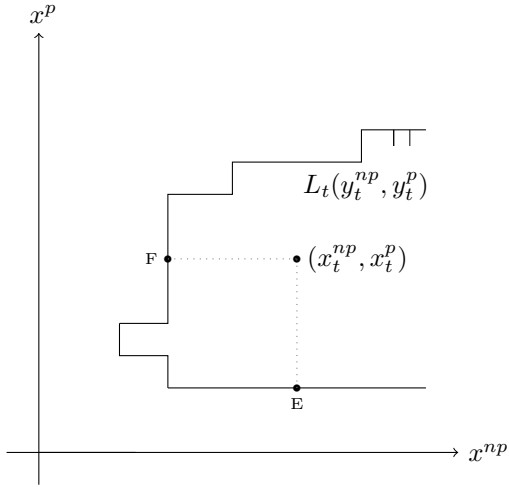

Figure 5: Input sub-vector polluting and no polluting additive distance functions

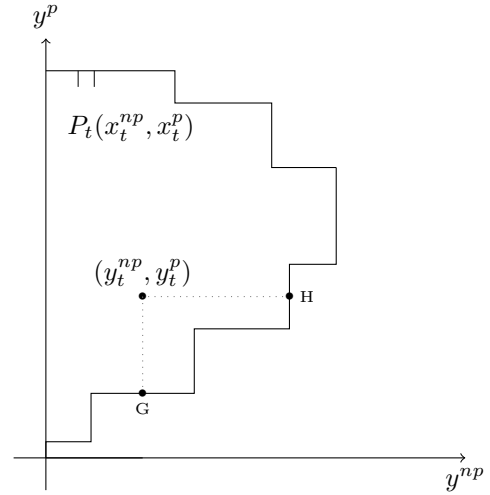

Figure 6: Output sub-vector polluting and no polluting additive distance functions

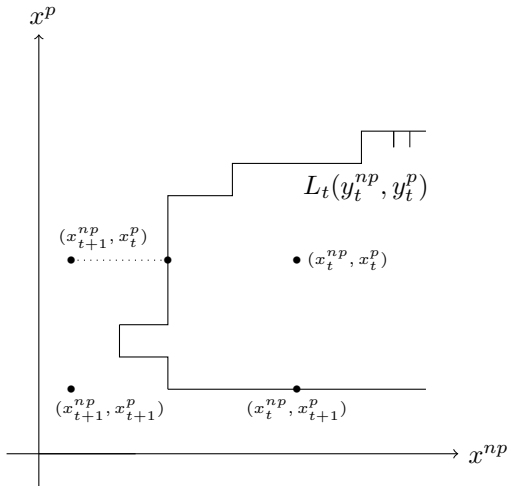

Figure 7: Cross-time polluting and no polluting input multiplicative distance function

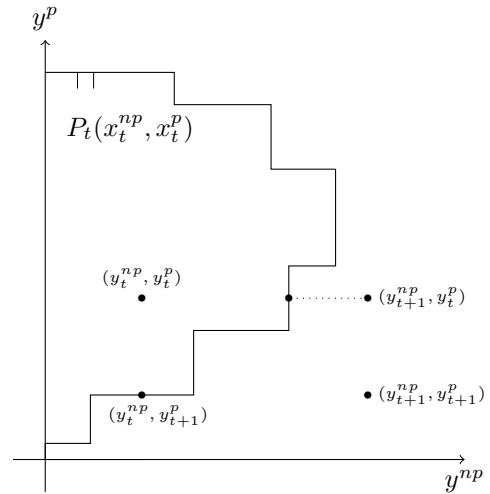

Figure 8: Cross-time no polluting and polluting output multiplicative distance function



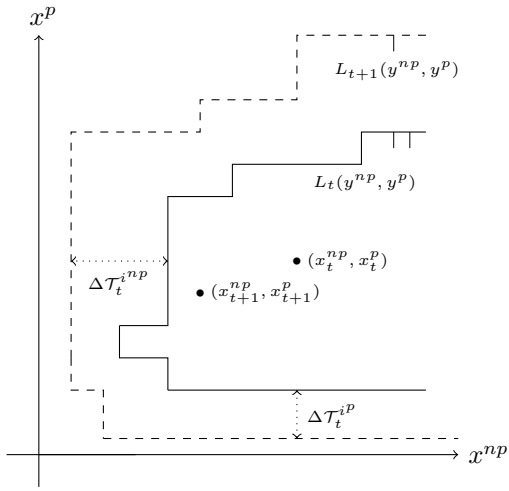

Figure 9: Input environmental disaggregated technical change

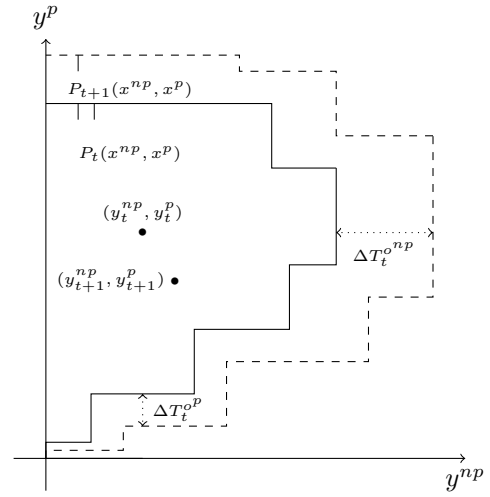

Figure 10: Output environmental disaggregated technical change

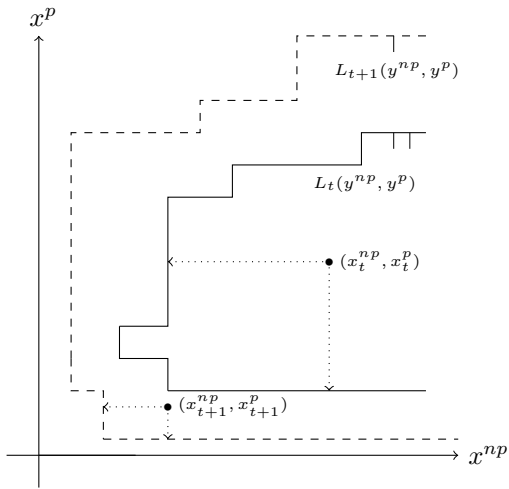

Figure 11: Input environmental disaggregated efficiency variation

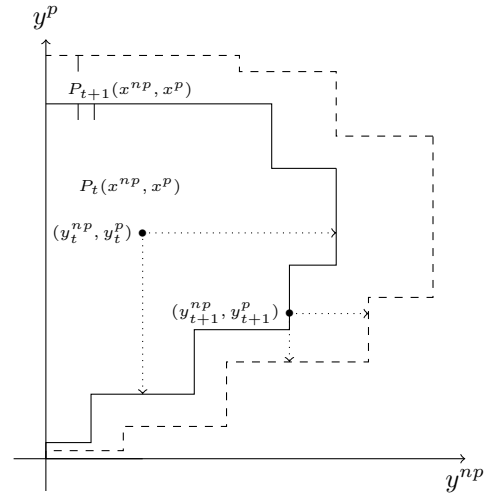

Figure 12: Output environmental disaggregated efficiency variation

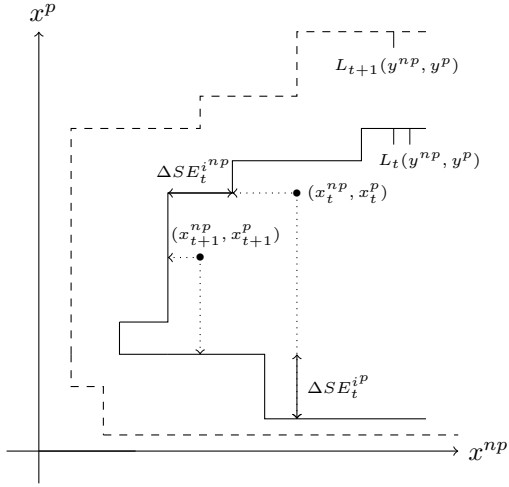

Figure 13: Input environmental disaggregated scale efficiency change

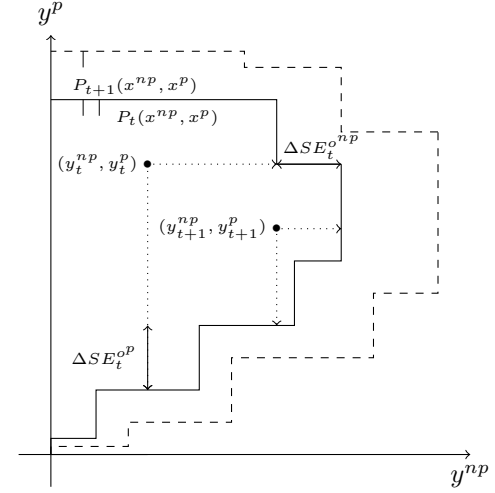

Figure 14: Output environmental disaggregated scale efficiency change

## Appendix 1

### Proof of Proposition 1

(a.1) and (a.2) are immediate from the definition of the multiplicative distance function  $\Psi_t(x_t, y_t)$ .

(a.3) Consider  $(x_t, y_t) \in T_t$ . For any  $\mu > 0$ , we have:

$$\begin{aligned} \Psi_t(\mu x_t, \mu y_t) &= \inf_{\theta} \left\{ \theta > 0 : \left( \theta^{\alpha^p}(\mu x_t^p), \theta^{\alpha^{np}}(\mu x_t^{np}), \theta^{\lambda^p}(\mu y_t^p), \theta^{\lambda^{np}}(\mu y_t^{np}) \right) \in T_t \right\} \\ &= \inf_{\theta} \left\{ \theta > 0 : \mu \cdot \left( \theta^{\alpha^p} x_t^p, \theta^{\alpha^{np}} x_t^{np}, \theta^{\lambda^p} y_t^p, \theta^{\lambda^{np}} y_t^{np} \right) \in T_t \right\} \\ &= \Psi_t(x_t, y_t). \end{aligned}$$

(a.4) For any observations  $(x_t, y_t) \in T_t$  and  $(\hat{x}_t, \hat{y}_t) \in T_t$  where

$(\hat{x}_t, \hat{y}_t) = (\rho^{\alpha^p} x_t^p, \rho^{\alpha^{np}} x_t^{np}, \rho^{\lambda^p} y_t^p, \rho^{\lambda^{np}} y_t^{np})$ , consider that:

$$\begin{aligned}
\Psi_t(\hat{x}_t, \hat{y}_t) &= \inf_{\theta} \left\{ \theta : \left( \theta^{\alpha^p} (\rho^{\alpha^p} x_t^p), \theta^{\alpha^{np}} (\rho^{\alpha^{np}} x_t^{np}), \theta^{\lambda^p} (\rho^{\lambda^p} y_t^p), \theta^{\lambda^{np}} (\rho^{\lambda^{np}} y_t^{np}) \right) \in T_t \right\} \\
&= \inf_{\theta} \left\{ \theta : \left( (\theta^{\alpha^p} \rho^{\alpha^p}) x_t^p, (\theta^{\alpha^{np}} \rho^{\alpha^{np}}) x_t^{np}, (\theta^{\lambda^p} \rho^{\lambda^p}) y_t^p, (\theta^{\lambda^{np}} \rho^{\lambda^{np}}) y_t^{np} \right) \in T_t \right\} \\
&= \inf_{\theta} \left\{ \theta : \left( (\theta \rho)^{\alpha^p} x_t^p, (\theta \rho)^{\alpha^{np}} x_t^{np}, (\theta \rho)^{\lambda^p} y_t^p, (\theta \rho)^{\lambda^{np}} y_t^{np} \right) \in T_t \right\} \\
&= \rho^{-1} \cdot \inf_{\delta} \left\{ \delta : \left( \delta^{\alpha^p} x_t^p, \delta^{\alpha^{np}} x_t^{np}, \delta^{\lambda^p} y_t^p, \delta^{\lambda^{np}} y_t^{np} \right) \in T_t \right\} \\
&= \rho^{-1} \cdot \Psi_t(x_t, y_t).
\end{aligned}$$

(a.5) Let  $(\hat{x}_t, \hat{y}_t) \in T_t$  be an observation with  $\hat{x}_t = x_t \otimes w_x$  and  $\hat{y}_t = y_t \otimes w_y$  where  $w_x$  and  $w_y$  are the weighting parameters related to the changing units of measurement of respectively input and output-vector components. Thus, the multiplicative distance function associated to this observation is as follows:  $\Psi_t(\hat{x}_t, \hat{y}_t) = \inf_{\theta} \{ \theta > 0 : (\theta^{\alpha^p} \hat{x}_t^p, \theta^{\alpha^{np}} \hat{x}_t^{np}, \theta^{\lambda^p} \hat{y}_t^p, \theta^{\lambda^{np}} \hat{y}_t^{np}) \in T_t \}$ . Since then, we have:

$$\begin{aligned}
\Psi_t(\hat{x}_t, \hat{y}_t) \otimes w &= \inf_{\theta} \left\{ \theta > 0 : \left( (\theta^{\alpha^p} \hat{x}_t^p) \otimes w_{x^p}, (\theta^{\alpha^{np}} \hat{x}_t^{np}) \otimes w_{x^{np}}, (\theta^{\lambda^p} \hat{y}_t^p) \otimes w_{y^p}, \right. \right. \\
&\quad \left. \left. (\theta^{\lambda^{np}} \hat{y}_t^{np}) \otimes w_{y^{np}} \right) \in T_t \right\} \\
&= \inf_{\theta} \left\{ \theta > 0 : (\theta^{\alpha^p} x_t^p, \theta^{\alpha^{np}} x_t^{np}, \theta^{\lambda^p} y_t^p, \theta^{\lambda^{np}} y_t^{np}) \in T_t \right\} \\
&= \Psi_t(x_t, y_t) \\
&\equiv \Psi_t(\hat{x}_t, \hat{y}_t).
\end{aligned}$$

(a.6) Let  $K$  be the cone defined as the intersection of the no polluting cone and the  $B$ -disposal cone such that  $K = K^{np} \cup K^B$ . Notice that  $K^{np} = (\mathbb{R}_+^{n^{np}}) \times (-\mathbb{R}_+^{m^{np}})$  and  $K^B = K^{x^p} \cup K^{y^p}$  where  $K^{x^p} = (-\mathbb{R}_+^{n^p}) \times (\mathbb{R}_+^{m^p})$  and  $K^{y^p} = (\mathbb{R}_+^{n^p}) \times (-\mathbb{R}_+^{m^p})$ . For two observations  $(x_t^p, x_t^{np}, y_t^p, y_t^{np})$  and  $(\bar{x}_t^p, \bar{x}_t^{np}, \bar{y}_t^p, \bar{y}_t^{np})$  such that  $(x_t^p, x_t^{np}, y_t^p, -y_t^{np}) \geq (\bar{x}_t^p, \bar{x}_t^{np}, \bar{y}_t^p, -\bar{y}_t^{np})$  then we have  $\{\theta : (\theta^{\alpha^p} x_t^p, \theta^{\alpha^{np}} x_t^{np}, \theta^{\lambda^p} y_t^p, \theta^{\lambda^{np}} y_t^{np}) \in (x_t^p, x_t^{np}, y_t^p, y_t^{np}) - K\} \subset \{\theta : (\theta^{\alpha^p} \bar{x}_t^p, \theta^{\alpha^{np}} \bar{x}_t^{np}, \theta^{\lambda^p} \bar{y}_t^p, \theta^{\lambda^{np}} \bar{y}_t^{np}) \in (\bar{x}_t^p, \bar{x}_t^{np}, \bar{y}_t^p, \bar{y}_t^{np}) - K\}$ . Moreover,  $\{\theta : (\theta^{\alpha^p} x_t^p, \theta^{\alpha^{np}} x_t^{np}, \theta^{\lambda^p} y_t^p, \theta^{\lambda^{np}} y_t^{np}) \in (\bar{x}_t^p, \bar{x}_t^{np}, \bar{y}_t^p, \bar{y}_t^{np}) - K\} \subset \{\theta : (\theta^{\alpha^p} \bar{x}_t^p, \theta^{\alpha^{np}} \bar{x}_t^{np}, \theta^{\lambda^p} \bar{y}_t^p, \theta^{\lambda^{np}} \bar{y}_t^{np}) \in (\bar{x}_t^p, \bar{x}_t^{np}, \bar{y}_t^p, \bar{y}_t^{np}) - K\}$ . Then,  $\{\theta : (\theta^{\alpha^p} x_t^p, \theta^{\alpha^{np}} x_t^{np}, \theta^{\lambda^p} y_t^p, \theta^{\lambda^{np}} y_t^{np}) \in (x_t^p, x_t^{np}, y_t^p, y_t^{np}) - K\} \subset \{\theta : (\theta^{\alpha^p} \bar{x}_t^p, \theta^{\alpha^{np}} \bar{x}_t^{np}, \theta^{\lambda^p} \bar{y}_t^p, \theta^{\lambda^{np}} \bar{y}_t^{np}) \in (\bar{x}_t^p, \bar{x}_t^{np}, \bar{y}_t^p, \bar{y}_t^{np}) - K\}$ . Consequently,  $\Psi_t(\bar{x}_t^p, \bar{x}_t^{np}, \bar{y}_t^p, \bar{y}_t^{np}) \geq \Psi_t(x_t^p, x_t^{np}, y_t^p, y_t^{np})$ .

### Proof of Proposition 3

(b.1) and (b.2) come from the definition of the additive distance function.

(b.3) For any  $(x_t, y_t)$  and any  $\lambda > 0$ , we have:

$$\begin{aligned}
\Xi_t(\lambda x_t, \lambda y_t) &= \sup_{\beta} \left\{ \beta \in \mathbb{R} : \left( (1 - \beta \odot \gamma^{np}) \lambda x_t^{np}, (1 - \beta \odot \gamma^p) \lambda x_t^p, \right. \right. \\
&\quad \left. \left. (1 + \beta \odot \sigma^{np}) \lambda y_t^{np}, (1 + \beta \odot \sigma^p) \lambda y_t^p \right) \in T_t \right\} \\
&= \sup_{\beta} \left\{ \beta \in \mathbb{R} : \lambda \left( (1 - \beta \odot \gamma^{np}) x_t^{np}, (1 - \beta \odot \gamma^p) x_t^p, (1 + \beta \odot \sigma^{np}) y_t^{np}, \right. \right. \\
&\quad \left. \left. (1 + \beta \odot \sigma^p) y_t^p \right) \in T_t \right\} \\
&= \Xi_t(x_t, y_t).
\end{aligned}$$

(b.4) For any  $(x_t, y_t) \in T_t$  and any  $(\hat{x}_t, \hat{y}_t) \in T_t$  where  $(\hat{x}_t, \hat{y}_t) = \left( (1 - \beta \odot \gamma^{np}) x_t^{np}, (1 - \beta \odot \gamma^p) x_t^p, (1 + \theta \odot \sigma^{np}) y_t^{np}, (1 + \theta \odot \sigma^p) y_t^p \right)$ , we have:

$$\begin{aligned}
\Xi_t(\hat{x}_t, \hat{y}_t) &= \sup_{\beta} \left\{ \beta \in \mathbb{R} : \left( (1 - \theta \odot \gamma^{np} - \beta \odot \gamma^{np}) x_t^{np}, (1 - \theta \odot \gamma^p - \beta \odot \gamma^p) x_t^p, \right. \right. \\
&\quad \left. \left. (1 + \theta \odot \sigma^{np} + \beta \odot \sigma^{np}) y_t^{np}, (1 + \theta \odot \sigma^p + \beta \odot \sigma^p) y_t^p \right) \in T_t \right\} \\
&= \sup_{\beta} \left\{ \beta \in \mathbb{R} : \left( (1 - (\theta + \beta) \odot \gamma^{np}) x_t^{np}, (1 - (\theta + \beta) \odot \gamma^p) x_t^p, \right. \right. \\
&\quad \left. \left. (1 + (\theta + \beta) \odot \sigma^{np}) y_t^{np}, (1 + (\theta + \beta) \odot \sigma^p) y_t^p \right) \in T_t \right\} \\
&= \sup_{\delta} \left\{ \delta \in \mathbb{R} : \left( (1 - \delta \odot \gamma^{np}) x_t^{np}, (1 - \delta \odot \gamma^p) x_t^p, (1 + \delta \odot \sigma^{np}) y_t^{np}, \right. \right. \\
&\quad \left. \left. (1 + \delta \odot \sigma^p) y_t^p \right) \in T_t \right\} - \theta \\
&= \Xi_t(x_t, y_t) - \theta.
\end{aligned}$$

(b.5) Suppose that any  $(\hat{x}_t, \hat{y}_t) \in T_t$  is such that  $\hat{x}_t = x_t \otimes w_x$  and  $\hat{y}_t = y_t \otimes w_y$  where  $w_x$  and  $w_y$  are the weighting parameters related to the changing units of measurement of inputs

and outputs. In such case, we have  $\Xi_t(\hat{x}_t, \hat{y}_t) = \sup_{\beta} \left\{ \beta \in \mathbb{R} : \left( (1 - \beta \odot \gamma^{np})x_t^{np}, (1 - \beta \odot \gamma^p)x_t^p, (1 + \beta \odot \sigma^{np})y_t^{np}, (1 + \beta \odot \sigma^p)y_t^p \right) \in T_t \right\}$ . Moreover,

$$\begin{aligned} \Xi_t(\hat{x}_t, \hat{y}_t) \odot w &= \sup_{\beta} \left\{ \beta \in \mathbb{R} : \left( ((1 - \beta \odot \gamma^{np})\hat{x}_t^{np}) \odot w_{x^{np}}, ((1 - \beta \odot \gamma^p)\hat{x}_t^p) \odot w_{x^p}, \right. \right. \\ &\quad \left. \left. ((1 + \beta \odot \sigma^{np})\hat{y}_t^{np}) \odot w_{y^{np}}, ((1 + \beta \odot \sigma^p)\hat{y}_t^p) \odot w_{y^p} \right) \in T_t \right\} \\ &= \sup_{\beta} \left\{ \beta \in \mathbb{R} : \left( (1 - \beta \odot \gamma^{np})x_t^{np}, (1 - \beta \odot \gamma^p)x_t^p, (1 + \beta \odot \sigma^{np})y_t^{np}, \right. \right. \\ &\quad \left. \left. (1 + \beta \odot \sigma^p)y_t^p \right) \in T_t \right\} \\ &= \Xi_t(x_t, y_t) \\ &\equiv \Xi_t(\hat{x}_t, \hat{y}_t). \end{aligned}$$

(b.6) Consider  $K$ , the union of convex cones defined as follows:  $K = K^{np} \cup K^B$  where  $K^B = K^{x^p} \cup K^{y^p}$ . Remark that  $K^{np} = (\mathbb{R}_+^{nnp}) \times (-\mathbb{R}_+^{mnp})$ ,  $K^{x^p} = (-\mathbb{R}_+^{np}) \times (\mathbb{R}_+^{mp})$  and  $K^{y^p} = (\mathbb{R}_+^{np}) \times (-\mathbb{R}_+^{mp})$ . For any observations  $(x_t^p, x_t^{np}, y_t^p, y_t^{np})$  and  $(\bar{x}_t^p, \bar{x}_t^{np}, \bar{y}_t^p, \bar{y}_t^{np})$  with  $(x_t^p, x_t^{np}, y_t^p, -y_t^{np}) \geq (\bar{x}_t^p, \bar{x}_t^{np}, \bar{y}_t^p, -\bar{y}_t^{np})$  then, we state that  $\left\{ \beta \in \mathbb{R} : \left( (1 - \beta \odot \gamma^{np})x_t^{np}, (1 - \beta \odot \gamma^p)x_t^p, (1 + \beta \odot \sigma^{np})y_t^{np}, (1 + \beta \odot \sigma^p)y_t^p \right) \in (\bar{x}_t^p, \bar{x}_t^{np}, \bar{y}_t^p, \bar{y}_t^{np}) - K \right\} \subset \left\{ \beta \in \mathbb{R} : \left( (1 - \beta \odot \gamma^{np})x_t^{np}, (1 - \beta \odot \gamma^p)x_t^p, (1 + \beta \odot \sigma^{np})y_t^{np}, (1 + \beta \odot \sigma^p)y_t^p \right) \in (x_t^p, x_t^{np}, y_t^p, y_t^{np}) - K \right\}$ . In addition,  $\left\{ \beta \in \mathbb{R} : \left( (1 - \beta \odot \gamma^{np})\bar{x}_t^{np}, (1 - \beta \odot \gamma^p)\bar{x}_t^p, (1 + \beta \odot \sigma^{np})\bar{y}_t^{np}, (1 + \beta \odot \sigma^p)\bar{y}_t^p \right) \in (\bar{x}_t^p, \bar{x}_t^{np}, \bar{y}_t^p, \bar{y}_t^{np}) - K \right\} \subset \left\{ \beta \in \mathbb{R} : \left( (1 - \beta \odot \gamma^{np})x_t^{np}, (1 - \beta \odot \gamma^p)x_t^p, (1 + \beta \odot \sigma^{np})y_t^{np}, (1 + \beta \odot \sigma^p)y_t^p \right) \in (\bar{x}_t^p, \bar{x}_t^{np}, \bar{y}_t^p, \bar{y}_t^{np}) - K \right\}$ . Then,  $\left\{ \beta \in \mathbb{R} : \left( (1 - \beta \odot \gamma^{np})\bar{x}_t^{np}, (1 - \beta \odot \gamma^p)\bar{x}_t^p, (1 + \beta \odot \sigma^{np})\bar{y}_t^{np}, (1 + \beta \odot \sigma^p)\bar{y}_t^p \right) \in (\bar{x}_t^p, \bar{x}_t^{np}, \bar{y}_t^p, \bar{y}_t^{np}) - K \right\} \subset \left\{ \beta \in \mathbb{R} : \left( (1 - \beta \odot \gamma^{np})x_t^{np}, (1 - \beta \odot \gamma^p)x_t^p, (1 + \beta \odot \sigma^{np})y_t^{np}, (1 + \beta \odot \sigma^p)y_t^p \right) \in (x_t^p, x_t^{np}, y_t^p, y_t^{np}) - K \right\}$ .

$\beta \odot \gamma^p x_t^p, (1 + \beta \odot \sigma^{np}) y_t^{np}, (1 + \beta \odot \sigma^p) y_t^p \in (\bar{x}_t^p, \bar{x}_t^{np}, \bar{y}_t^p, \bar{y}_t^{np}) - K \}$ . Consequently, we have  
 $\Xi_t(x_t, y_t) \geq \Xi_t(\bar{x}_t, \bar{y}_t)$ .

## Appendix 2

Consider a  $B$ -disposable production technology  $T_t$  and a set of  $Z$  observations such that  $\mathcal{Z} = \{0, 1, \dots, Z\}$  with  $z \in \mathcal{Z}$ . For any  $(x_t, y_t) \in \mathbb{R}_+^{n+m}$  we have  $x_t = (x_t^p, x_t^{np}) \in \mathbb{R}_+^{n^p+n^{np}}$  and  $y_t = (y_t^p, y_t^{np}) \in \mathbb{R}_+^{m^p+m^{np}}$  such that  $[n] = [n^p] + [n^{np}]$  and  $[m] = [m^p] + [m^{np}]$ . Notice that  $[n^p] = \text{Card}(x^p)$ ,  $[n^{np}] = \text{Card}(x^{np})$ ,  $[m^p] = \text{Card}(y^p)$  and  $[m^{np}] = \text{Card}(y^{np})$ .

The mathematical programs introduced below, allow to estimate the efficiency score of production units in a Data Envelopment Analysis approach.

### Mathematical program of multiplicative distance function under convex production set

The mathematical program for the observation 0 is as follows:

$$\begin{aligned}
 \Psi_t(x_t^0, y_t^0) &= \inf \theta \\
 \text{s.t} \quad & \theta^{\alpha^{np}} x_t^{0,i} \geq \sum_{z \in \mathcal{Z}} \eta^z x_t^{z,i} & i \in [n^{np}] \\
 & \theta^{\alpha^p} x_t^{0,i} \leq \sum_{z \in \mathcal{Z}} \eta^z x_t^{z,i} & i \in [n^p] \\
 & \theta^{\alpha^{np}} x_t^{0,i} \geq \sum_{z \in \mathcal{Z}} \mu^z x_t^{z,i} & i \in [n^{np}] \\
 & \theta^{\alpha^p} x_t^{0,i} \geq \sum_{z \in \mathcal{Z}} \mu^z x_t^{z,i} & i \in [n^p] \\
 & \theta^{\lambda^{np}} y_t^{0,j} \leq \sum_{z \in \mathcal{Z}} \eta^z y_t^{z,j} & j \in [m^{np}] \\
 & \theta^{\lambda^p} y_t^{0,j} \geq \sum_{z \in \mathcal{Z}} \eta^z y_t^{z,j} & j \in [m^p] \\
 & \theta^{\lambda^{np}} y_t^{0,j} \leq \sum_{z \in \mathcal{Z}} \mu^z y_t^{z,j} & j \in [m^{np}] \\
 & \theta^{\lambda^p} y_t^{0,j} \leq \sum_{z \in \mathcal{Z}} \mu^z y_t^{z,j} & j \in [m^p] \\
 & \sum_{z \in \mathcal{Z}} \eta = \sum_{z \in \mathcal{Z}} \mu_z = 1, \quad \theta \geq 0, \quad \mu \geq 0.
 \end{aligned}$$

Notice that  $\alpha^{np} = \alpha^p = \{0, 1\}$ ,  $\lambda^{np} = \{-1, 0\}$  and  $\lambda^p = \{0, 1\}$ . Moreover, remark that in this paper, we focus on the following four cases :

- (i)  $\alpha^{np} = 1$  and  $\alpha^p = \lambda^{np} = \lambda^p = 0$ .
- (ii)  $\alpha^p = 1$  and  $\alpha^{np} = \lambda^{np} = \lambda^p = 0$ .
- (iii)  $\lambda^{np} = -1$  and  $\alpha^p = \alpha^{np} = \lambda^p = 0$ .
- (iv)  $\lambda^p = 1$  and  $\alpha^p = \alpha^{np} = \lambda^{np} = 0$ .

### Mathematical programs of multiplicative distance function under non convex production technology

According to the cases quoted above, the programs related to these cases are provided below when the production set is non convex:

- (i)  $\alpha^{np} = 1$  and  $\alpha^p = \lambda^{np} = \lambda^p = 0$

$$\Psi_t^{i^{np}}(x_t, y_t) = \max_{\substack{z \in \mathcal{Z} \\ i \in [n^{np}]}} \left( \frac{x_t^{z,i}}{x_t^{0,i}} \right).$$

*Proof:* Consider that for  $\alpha^{np} = 1$  and  $\alpha^p = \lambda^{np} = \lambda^p = 0$ , we have:

$$\begin{aligned} \Psi_t^{i^{np}}(x_t, y_t) &= \max_{z \in \mathcal{Z}} \left\{ \min_{z \in \mathcal{Z}} \left\{ \theta : \theta x_t^{0,i} \geq x_t^{z,i}, x_t^{0,r} \geq x_t^{z,r}, y_t^{0,j} \leq y_t^{z,j}, y_t^{0,s} \leq y_t^{z,s} \right\}; \right. \\ &\quad \left. \min_{z \in \mathcal{Z}} \left\{ \theta : \theta x_t^{0,i} \geq x_t^{z,i}, x_t^{0,r} \leq x_t^{z,r}, y_t^{0,j} \leq y_t^{z,j}, y_t^{0,s} \geq y_t^{z,s} \right\}; \right. \\ &\quad \left. i \in [n^{np}], r \in [n^p], j \in [m^{np}], s \in [m^p] \right\} \\ &= \max_{z \in \mathcal{Z}} \left\{ \min_{z \in \mathcal{Z}} \left\{ \theta : \theta \geq \frac{x_t^{z,i}}{x_t^{0,i}}, x_t^{0,r} \geq x_t^{z,r}, y_t^{0,j} \leq y_t^{z,j}, y_t^{0,s} \leq y_t^{z,s} \right\}; \right. \\ &\quad \left. \min_{z \in \mathcal{Z}} \left\{ \theta : \theta \geq \frac{x_t^{z,i}}{x_t^{0,i}}, x_t^{0,r} \leq x_t^{z,r}, y_t^{0,j} \leq y_t^{z,j}, y_t^{0,s} \geq y_t^{z,s} \right\}; \right. \\ &\quad \left. i \in [n^{np}], r \in [n^p], j \in [m^{np}], s \in [m^p] \right\} \\ &= \max_{\substack{z \in \mathcal{Z} \\ i \in [n^{np}]}} \left( \frac{x_t^{z,i}}{x_t^{0,i}} \right). \end{aligned}$$

- (ii)  $\alpha^p = 1$  and  $\alpha^{np} = \lambda^{np} = \lambda^p = 0$

$$\Psi_t^{i^p}(x_t, y_t) = \max_{\substack{z \in \mathcal{Z} \\ r \in [n^p]}} \left( \frac{x_t^{z,r}}{x_t^{0,r}} \right).$$



(iii)  $\lambda^{np} = -1$  and  $\alpha^{np} = \alpha^p = \lambda^p = 0$

$$\Psi_t^{\alpha^{np}}(x_t, y_t) = \max_{\substack{z \in \mathcal{Z} \\ j \in [m^{np}]}} \left( \frac{y_t^{0,j}}{y_t^{z,j}} \right).$$

(iv)  $\lambda^p = 1$  and  $\alpha^{np} = \alpha^p = \lambda^{np} = 0$

$$\Psi_t^{\alpha^p}(x_t, y_t) = \max_{\substack{z \in \mathcal{Z} \\ s \in [m^{np}]}} \left( \frac{y_t^{z,s}}{y_t^{0,s}} \right).$$

Proofs of (ii), (iii) and (iv) are similar to the proof of (i).

## Mathematical program of additive distance function under convex production set

The mathematical program associated to the observation 0 is presented below:

$$\begin{aligned}
\Xi_t(x_t^0, y_t^0) &= \sup \beta \\
\text{s.t} \quad & x_t^{0,i} - \beta \gamma^{np} x_t^{0,i} \geq \sum_{z \in \mathcal{Z}} \eta^z x_t^{z,i} & i \in [n^{np}] \\
& x_t^{0,i} - \beta \gamma^p x_t^{0,i} \leq \sum_{z \in \mathcal{Z}} \eta^z x_t^{z,i} & i \in [n^p] \\
& x_t^{0,i} - \beta \gamma^{np} x_t^{0,i} \geq \sum_{z \in \mathcal{Z}} \mu^z x_t^{z,i} & i \in [n^{np}] \\
& x_t^{0,i} - \beta \gamma^p x_t^{0,i} \geq \sum_{z \in \mathcal{Z}} \mu^z x_t^{z,i} & i \in [n^p] \\
& y_t^{0,j} + \beta \sigma^{np} y_t^{0,j} \leq \sum_{z \in \mathcal{Z}} \eta^z y_t^{z,j} & j \in [m^{np}] \\
& y_t^{0,j} + \beta \sigma^p y_t^{0,j} \geq \sum_{z \in \mathcal{Z}} \eta^z y_t^{z,j} & j \in [m^p] \\
& y_t^{0,j} + \beta \sigma^{np} y_t^{0,j} \leq \sum_{z \in \mathcal{Z}} \mu^z y_t^{z,j} & j \in [m^{np}] \\
& y_t^{0,j} + \beta \sigma^p y_t^{0,j} \leq \sum_{z \in \mathcal{Z}} \mu^z y_t^{z,j} & j \in [m^p] \\
& \sum_{z \in \mathcal{Z}} \eta = \sum_{z \in \mathcal{Z}} \mu_z = 1, \quad \theta \geq 0, \quad \mu \geq 0.
\end{aligned}$$

Remark that  $(\gamma^{np}, \gamma^p) \in [0, 1]^{n^{np} + n^p}$  and  $(\sigma^{np}, \sigma^p) \in [0, 1]^{m^{np}} \times [-1, 0]^{m^p}$ . In addition, this paper focus on the cases where:

- (i)  $\gamma^{np} = 1$  and  $\gamma^p = \sigma^{np} = \sigma^p = 0$ ;
- (ii)  $\gamma^p = 1$  and  $\gamma^{np} = \sigma^{np} = \sigma^p = 0$ ;
- (iii)  $\sigma^{np} = 1$  and  $\gamma^{np} = \gamma^p = \sigma^p = 0$ ;
- (iv)  $\sigma^p = -1$  and  $\gamma^{np} = \gamma^p = \sigma^{np} = 0$ .

## Mathematical programs of the additive distance function under non convex production technology

As stated above, the programs proposed in this section are subjected to the four cases quoted previously.

(i)  $\gamma^{np} = 1$  and  $\gamma^p = \sigma^{np} = \sigma^p = 0$

$$\Xi_t^{i^{np}} = \min_{\substack{z \in \mathcal{Z} \\ i \in [n^{np}]}} \left( 1 - \frac{x_t^{z,i}}{x_t^{0,i}} \right).$$

*Proof:* For  $\gamma^{np} = 1$  and  $\gamma^p = \sigma^{np} = \sigma^p = 0$  we have:

$$\begin{aligned} \Xi_t^{i^{np}}(x_t, y_t) &= \min_{z \in \mathcal{Z}} \left\{ \max_{z \in \mathcal{Z}} \left\{ \beta : (1 - \beta)x_t^{0,i} \geq x_t^{z,i}, x_t^{0,r} \geq x_t^{z,r}, y_t^{0,j} \leq y_t^{z,j}, y_t^{0,s} \leq y_t^{z,s} \right\}; \right. \\ &\quad \left. \max_{z \in \mathcal{Z}} \left\{ \beta : (1 - \beta)x_t^{0,i} \geq x_t^{z,i}, x_t^{0,r} \leq x_t^{z,r}, y_t^{0,j} \leq y_t^{z,j}, y_t^{0,s} \geq y_t^{z,s} \right\}; \right. \\ &\quad \left. i \in [n^{np}], r \in [n^p], j \in [m^{np}], s \in [m^p] \right\} \\ &= \min_{z \in \mathcal{Z}} \left\{ \max_{z \in \mathcal{Z}} \left\{ \beta : \beta \leq 1 - \frac{x_t^{z,i}}{x_t^{0,i}}, x_t^{0,r} \geq x_t^{z,r}, y_t^{0,j} \leq y_t^{z,j}, y_t^{0,s} \leq y_t^{z,s} \right\}; \right. \\ &\quad \left. \max_{z \in \mathcal{Z}} \left\{ \beta : \beta \leq 1 - \frac{x_t^{z,i}}{x_t^{0,i}}, x_t^{0,r} \leq x_t^{z,r}, y_t^{0,j} \leq y_t^{z,j}, y_t^{0,s} \geq y_t^{z,s} \right\}; \right. \\ &\quad \left. i \in [n^{np}], r \in [n^p], j \in [m^{np}], s \in [m^p] \right\} \\ &= \min_{\substack{z \in \mathcal{Z} \\ i \in [n^{np}]}} \left( 1 - \frac{x_t^{z,i}}{x_t^{0,i}} \right). \end{aligned}$$

(ii)  $\gamma^p = 1$  and  $\gamma^{np} = \sigma^{np} = \sigma^p = 0$

$$\Xi_t^{i^p}(x_t, y_t) = \min_{\substack{z \in \mathcal{Z} \\ r \in [n^p]}} \left( 1 - \frac{x_t^{z,r}}{x_t^{0,r}} \right).$$

(iii)  $\sigma^{np} = 1$  and  $\gamma^{np} = \gamma^p = \sigma^p = 0$

$$\Xi_t^{\sigma^{np}}(x_t, y_t) = \min_{\substack{z \in \mathcal{Z} \\ j \in [m^{np}]}} \left( \frac{y_t^{z,j}}{y_t^{0,j}} - 1 \right).$$

(iv)  $\sigma^p = -1$  and  $\gamma^{np} = \gamma^p = \sigma^{np} = 0$

$$\Xi_t^{o^p}(x_t, y_t) = \min_{\substack{z \in \mathcal{Z} \\ s \in [m^p]}} \left( 1 - \frac{y_t^{z,s}}{y_t^{0,s}} \right).$$

Proofs of cases (ii), (iii) and (iv) are similar to the proof of (i). Hence, they are omitted.

## Appendix 3

Technical change			
	$a = \Delta T_{t,t+1}^{o^p} > 1$	$b = \Delta T_{t,t+1}^{o^p} < 1$	$\Delta T_{t,t+1}^{o^p} = 1$
$c = \Delta T_{t,t+1}^{o^{np}} > 1$	$\Delta EDT_{t,t+1} > 1$	i. If $c > b^{-1}$ then, $\Delta EDT_{t,t+1} > 1$ ii. If $c < b^{-1}$ then, $\Delta EDT_{t,t+1} < 1$	$\Delta EDT_{t,t+1} = c > 1$
$d = \Delta T_{t,t+1}^{o^{np}} < 1$	i. If $d^{-1} < a$ then, $\Delta EDT_{t,t+1} > 1$ ii. If $d^{-1} > a$ then, $\Delta EDT_{t,t+1} < 1$	$\Delta EDT_{t,t+1} < 1$	$\Delta EDT_{t,t+1} = d < 1$
$\Delta T_{t,t+1}^{o^{np}} = 1$	$\Delta EDT_{t,t+1} = a > 1$	$\Delta EDT_{t,t+1} = b < 1$	$\Delta EDT_{t,t+1} = 1$
Efficiency variation			
	$e = \Delta EC_{t,t+1}^{o^p} > 1$	$f = \Delta EC_{t,t+1}^{o^p} < 1$	$\Delta EC_{t,t+1}^{o^p} = 1$
$g = \Delta EC_{t,t+1}^{o^{np}} > 1$	$\Delta EDE_{t,t+1} > 1$	i. If $g > f^{-1}$ then, $\Delta EDE_{t,t+1} > 1$ ii. If $g < f^{-1}$ then, $\Delta EDE_{t,t+1} < 1$	$\Delta EDE_{t,t+1} = g > 1$
$h = \Delta EC_{t,t+1}^{o^{np}} < 1$	i. If $h^{-1} < e$ then, $\Delta EDE_{t,t+1} > 1$ ii. If $h^{-1} > e$ then, $\Delta EDE_{t,t+1} < 1$	$\Delta EDE_{t,t+1} < 1$	$\Delta EDE_{t,t+1} = h < 1$
$\Delta EC_{t,t+1}^{o^{np}} = 1$	$\Delta EDE_{t,t+1} = e > 1$	$\Delta EDE_{t,t+1} = f < 1$	$\Delta EDE_{t,t+1} = 1$
Scale efficiency change			
	$j = \Delta SE_{t,t+1}^{o^p} > 1$	$k = \Delta SE_{t,t+1}^{o^p} < 1$	$\Delta SE_{t,t+1}^{o^p} = 1$
$l = \Delta SE_{t,t+1}^{o^{np}} > 1$	$\Delta EDS_{t,t+1} > 1$	i. If $l > k^{-1}$ then, $\Delta EDS_{t,t+1} > 1$ ii. If $l < k^{-1}$ then, $\Delta EDS_{t,t+1} < 1$	$\Delta EDS_{t,t+1} = l > 1$
$q = \Delta SE_{t,t+1}^{o^{np}} < 1$	i. If $q^{-1} < j$ then, $\Delta EDS_{t,t+1} > 1$ ii. If $q^{-1} > j$ then, $\Delta EDS_{t,t+1} < 1$	$\Delta EDS_{t,t+1} < 1$	$\Delta EDS_{t,t+1} = q < 1$
$\Delta SE_{t,t+1}^{o^{np}} = 1$	$\Delta EDS_{t,t+1} = j > 1$	$\Delta EDS_{t,t+1} = k < 1$	$\Delta EDS_{t,t+1} = 1$

Table 1: Decomposition of EDHM (output direction)

Technical change			
	$a = \Delta\mathcal{T}_{t,t+1}^{ip} > 1$	$b = \Delta\mathcal{T}_{t,t+1}^{ip} < 1$	$\Delta\mathcal{T}_{t,t+1}^{ip} = 1$
$c = \Delta\mathcal{T}_{t,t+1}^{inp} > 1$	$\Delta\mathcal{EDT}_{t,t+1} > 1$	i. If $c > b^{-1}$ then, $\Delta\mathcal{EDT}_{t,t+1} > 1$ ii. If $c < b^{-1}$ then, $\Delta\mathcal{EDT}_{t,t+1} < 1$	$\Delta\mathcal{EDT}_{t,t+1} = c > 1$
$d = \Delta\mathcal{T}_{t,t+1}^{inp} < 1$	i. If $d^{-1} < a$ then, $\Delta\mathcal{EDT}_{t,t+1} > 1$ ii. If $d^{-1} > a$ then, $\Delta\mathcal{EDT}_{t,t+1} < 1$	$\Delta\mathcal{EDT}_{t,t+1} < 1$	$\Delta\mathcal{EDT}_{t,t+1} = d < 1$
$\Delta\mathcal{T}_{t,t+1}^{inp} = 1$	$\Delta\mathcal{EDT}_{t,t+1} = a > 1$	$\Delta\mathcal{EDT}_{t,t+1} = b < 1$	$\Delta\mathcal{EDT}_{t,t+1} = 1$
Efficiency variation			
	$e = \Delta\mathcal{EC}_{t,t+1}^{ip} > 1$	$f = \Delta\mathcal{EC}_{t,t+1}^{ip} < 1$	$\Delta\mathcal{EC}_{t,t+1}^{ip} = 1$
$g = \Delta\mathcal{EC}_{t,t+1}^{inp} > 1$	$\Delta\mathcal{EDE}_{t,t+1} > 1$	i. If $g > f^{-1}$ then, $\Delta\mathcal{EDE}_{t,t+1} > 1$ ii. If $g < f^{-1}$ then, $\Delta\mathcal{EDE}_{t,t+1} < 1$	$\Delta\mathcal{EDE}_{t,t+1} = g > 1$
$h = \Delta\mathcal{EC}_{t,t+1}^{inp} < 1$	i. If $h^{-1} < e$ then, $\Delta\mathcal{EDE}_{t,t+1} > 1$ ii. If $h^{-1} > e$ then, $\Delta\mathcal{EDE}_{t,t+1} < 1$	$\Delta\mathcal{EDE}_{t,t+1} < 1$	$\Delta\mathcal{EDE}_{t,t+1} = h < 1$
$\Delta\mathcal{EC}_{t,t+1}^{inp} = 1$	$\Delta\mathcal{EDE}_{t,t+1} = e > 1$	$\Delta\mathcal{EDE}_{t,t+1} = f < 1$	$\Delta\mathcal{EDE}_{t,t+1} = 1$
Scale efficiency change			
	$j = \Delta\mathcal{SE}_{t,t+1}^{ip} > 1$	$k = \Delta\mathcal{SE}_{t,t+1}^{ip} < 1$	$\Delta\mathcal{SE}_{t,t+1}^{ip} = 1$
$l = \Delta\mathcal{SE}_{t,t+1}^{inp} > 1$	$\Delta\mathcal{EDS}_{t,t+1} > 1$	i. If $l > k^{-1}$ then, $\Delta\mathcal{EDS}_{t,t+1} > 1$ ii. If $l < k^{-1}$ then, $\Delta\mathcal{EDS}_{t,t+1} < 1$	$\Delta\mathcal{EDS}_{t,t+1} = l > 1$
$q = \Delta\mathcal{SE}_{t,t+1}^{inp} < 1$	i. If $q^{-1} < j$ then, $\Delta\mathcal{EDS}_{t,t+1} > 1$ ii. If $q^{-1} > j$ then, $\Delta\mathcal{EDS}_{t,t+1} < 1$	$\Delta\mathcal{EDS}_{t,t+1} < 1$	$\Delta\mathcal{EDS}_{t,t+1} = q < 1$
$\Delta\mathcal{SE}_{t,t+1}^{inp} = 1$	$\Delta\mathcal{EDS}_{t,t+1} = j > 1$	$\Delta\mathcal{EDS}_{t,t+1} = k < 1$	$\Delta\mathcal{EDS}_{t,t+1} = 1$

Table 2: Decomposition of EDHM (input direction)

Technical change			
	$a = \Delta T_{t,t+1}^{o^p} > 0$	$b = \Delta T_{t,t+1}^{o^p} < 0$	$\Delta T_{t,t+1}^{o^p} = 0$
$c = \Delta T_{t,t+1}^{o^{np}} > 0$	$\Delta EDT_{t,t+1} > 0$	i. If $ c  >  b $ then, $\Delta EDT_{t,t+1} > 0$ ii. If $ c  <  b $ then, $\Delta EDT_{t,t+1} < 0$	$\Delta EDT_{t,t+1} = c > 0$
$d = \Delta T_{t,t+1}^{o^{np}} < 0$	i. If $ d  <  a $ then, $\Delta EDT_{t,t+1} > 0$ ii. If $ d  >  a $ then, $\Delta EDT_{t,t+1} < 0$	$\Delta EDT_{t,t+1} < 0$	$\Delta EDT_{t,t+1} = d < 0$
$\Delta T_{t,t+1}^{o^{np}} = 0$	$\Delta EDT_{t,t+1} = a > 0$	$\Delta EDT_{t,t+1} = b < 0$	$\Delta EDT_{t,t+1} = 0$
Efficiency variation			
	$e = \Delta EC_{t,t+1}^{o^p} > 0$	$f = \Delta EC_{t,t+1}^{o^p} < 0$	$\Delta EC_{t,t+1}^{o^p} = 0$
$g = \Delta EC_{t,t+1}^{o^{np}} > 0$	$\Delta EDE_{t,t+1} > 0$	i. If $ g  >  f $ then, $\Delta EDE_{t,t+1} > 0$ ii. If $ g  <  f $ then, $\Delta EDE_{t,t+1} < 0$	$\Delta EDE_{t,t+1} = g > 0$
$h = \Delta EC_{t,t+1}^{o^{np}} < 0$	i. If $ h  <  e $ then, $\Delta EDE_{t,t+1} > 0$ ii. If $ h  >  e $ then, $\Delta EDE_{t,t+1} < 0$	$\Delta EDE_{t,t+1} < 0$	$\Delta EDE_{t,t+1} = h < 0$
$\Delta EC_{t,t+1}^{o^{np}} = 0$	$\Delta EDE_{t,t+1} = e > 0$	$\Delta EDE_{t,t+1} = f < 0$	$\Delta EDE_{t,t+1} = 0$
Scale efficiency change			
	$j = \Delta SE_{t,t+1}^{o^p} > 0$	$k = \Delta SE_{t,t+1}^{o^p} < 0$	$\Delta SE_{t,t+1}^{o^p} = 0$
$l = \Delta SE_{t,t+1}^{o^{np}} > 0$	$\Delta EDS_{t,t+1} > 0$	i. If $ l  >  k $ then, $\Delta EDS_{t,t+1} > 0$ ii. If $ l  <  k $ then, $\Delta EDS_{t,t+1} < 0$	$\Delta EDS_{t,t+1} = l > 0$
$q = \Delta SE_{t,t+1}^{o^{np}} < 0$	i. If $ q  <  j $ then, $\Delta EDS_{t,t+1} > 0$ ii. If $ q  >  j $ then, $\Delta EDS_{t,t+1} < 0$	$\Delta EDS_{t,t+1} < 0$	$\Delta EDS_{t,t+1} = q < 0$
$\Delta SE_{t,t+1}^{o^{np}} = 0$	$\Delta EDS_{t,t+1} = j > 0$	$\Delta EDS_{t,t+1} = k < 0$	$\Delta EDS_{t,t+1} = 0$

Table 3: Decomposition of EDLHM (output direction)



Technical change			
	$a = \Delta \mathcal{T}_{t,t+1}^{ip} > 0$	$b = \Delta \mathcal{T}_{t,t+1}^{ip} < 0$	$\Delta \mathcal{T}_{t,t+1}^{ip} = 0$
$c = \Delta \mathcal{T}_{t,t+1}^{inp} > 0$	$\Delta \mathcal{EDT}_{t,t+1} > 0$	i. If $ c  >  b $ then, $\Delta \mathcal{EDT}_{t,t+1} > 0$ ii. If $ c  <  b $ then, $\Delta \mathcal{EDT}_{t,t+1} < 0$	$\Delta \mathcal{EDT}_{t,t+1} = c > 0$
$d = \Delta \mathcal{T}_{t,t+1}^{inp} < 0$	i. If $ d  <  a $ then, $\Delta \mathcal{EDT}_{t,t+1} > 0$ ii. If $ d  >  a $ then, $\Delta \mathcal{EDT}_{t,t+1} < 0$	$\Delta \mathcal{EDT}_{t,t+1} < 0$	$\Delta \mathcal{EDT}_{t,t+1} = d < 0$
$\Delta \mathcal{T}_{t,t+1}^{inp} = 0$	$\Delta \mathcal{EDT}_{t,t+1} = a > 0$	$\Delta \mathcal{EDT}_{t,t+1} = b < 0$	$\Delta \mathcal{EDT}_{t,t+1} = 0$
Efficiency variation			
	$e = \Delta \mathcal{EC}_{t,t+1}^{ip} > 0$	$f = \Delta \mathcal{EC}_{t,t+1}^{ip} < 0$	$\Delta \mathcal{EC}_{t,t+1}^{ip} = 0$
$g = \Delta \mathcal{EC}_{t,t+1}^{inp} > 0$	$\Delta \mathcal{EDE}_{t,t+1} > 0$	i. If $ g  >  f $ then, $\Delta \mathcal{EDE}_{t,t+1} > 0$ ii. If $ g  <  f $ then, $\Delta \mathcal{EDE}_{t,t+1} < 0$	$\Delta \mathcal{EDE}_{t,t+1} = g > 0$
$h = \Delta \mathcal{EC}_{t,t+1}^{inp} < 0$	i. If $ h  <  e $ then, $\Delta \mathcal{EDE}_{t,t+1} > 0$ ii. If $ h  >  e $ then, $\Delta \mathcal{EDE}_{t,t+1} < 0$	$\Delta \mathcal{EDE}_{t,t+1} < 0$	$\Delta \mathcal{EDE}_{t,t+1} = h < 0$
$\Delta \mathcal{EC}_{t,t+1}^{inp} = 0$	$\Delta \mathcal{EDE}_{t,t+1} = e > 0$	$\Delta \mathcal{EDE}_{t,t+1} = f < 0$	$\Delta \mathcal{EDE}_{t,t+1} = 0$
Scale efficiency change			
	$j = \Delta \mathcal{SE}_{t,t+1}^{ip} > 0$	$k = \Delta \mathcal{SE}_{t,t+1}^{ip} < 0$	$\Delta \mathcal{SE}_{t,t+1}^{ip} = 0$
$l = \Delta \mathcal{SE}_{t,t+1}^{inp} > 0$	$\Delta \mathcal{EDS}_{t,t+1} > 0$	i. If $ l  >  k $ then, $\Delta \mathcal{EDS}_{t,t+1} > 0$ ii. If $ l  <  k $ then, $\Delta \mathcal{EDS}_{t,t+1} < 0$	$\Delta \mathcal{EDS}_{t,t+1} = l > 0$
$q = \Delta \mathcal{SE}_{t,t+1}^{inp} < 0$	i. If $ q  <  j $ then, $\Delta \mathcal{EDS}_{t,t+1} > 0$ ii. If $ q  >  j $ then, $\Delta \mathcal{EDS}_{t,t+1} < 0$	$\Delta \mathcal{EDS}_{t,t+1} < 0$	$\Delta \mathcal{EDS}_{t,t+1} = q < 0$
$\Delta \mathcal{SE}_{t,t+1}^{inp} = 0$	$\Delta \mathcal{EDS}_{t,t+1} = j > 0$	$\Delta \mathcal{EDS}_{t,t+1} = k < 0$	$\Delta \mathcal{EDS}_{t,t+1} = 0$

Table 4: Decomposition of EDLHM (input direction)