



**HAL**  
open science

# Microemulsion breakdown by pervaporation technique: Effect of the alkyl chain length of n-alkanol, a cosurfactant of the microemulsion

Saâd Moulay, Amel Hadj-Ziane-Zafour, Jean-Paul Canselier

## ► To cite this version:

Saâd Moulay, Amel Hadj-Ziane-Zafour, Jean-Paul Canselier. Microemulsion breakdown by pervaporation technique: Effect of the alkyl chain length of n-alkanol, a cosurfactant of the microemulsion. *Journal of Colloid and Interface Science*, 2007, 311 (2), pp.556. 10.1016/j.jcis.2007.02.069 . hal-03592086

**HAL Id: hal-03592086**

**<https://hal.science/hal-03592086>**

Submitted on 1 Mar 2022

**HAL** is a multi-disciplinary open access archive for the deposit and dissemination of scientific research documents, whether they are published or not. The documents may come from teaching and research institutions in France or abroad, or from public or private research centers.

L'archive ouverte pluridisciplinaire **HAL**, est destinée au dépôt et à la diffusion de documents scientifiques de niveau recherche, publiés ou non, émanant des établissements d'enseignement et de recherche français ou étrangers, des laboratoires publics ou privés.



## Open Archive Toulouse Archive Ouverte (OATAO)

OATAO is an open access repository that collects the work of Toulouse researchers and makes it freely available over the web where possible.

This is an author-deposited version published in: <http://oatao.univ-toulouse.fr/>  
Eprints ID : 3075

### To link to this article :

URL : <http://dx.doi.org/10.1016/j.jcis.2007.02.069>

**To cite this version** : Canselier, Jean-Paul and Moulay, Saâd and Zafour Hadj-Ziane, A. ( 2007) *Microemulsion breakdown by pervaporation technique: Effect of the alkyl chain length of n-alkanol, a cosurfactant of the microemulsion.* Journal of Colloid and Interface Science, Vol.311 (n°2). pp. 556--561 . ISSN 0021-9797

Any correspondence concerning this service should be sent to the repository administrator: [staff-oatao@inp-toulouse.fr](mailto:staff-oatao@inp-toulouse.fr)

# Microemulsion breakdown by pervaporation technique: Effect of the alkyl chain length of *n*-alkanol, a cosurfactant of the microemulsion

Saâd Moulay<sup>a,\*</sup>, Amel Zafour Hadj-Ziane<sup>a</sup>, Jean-Paul Canselier<sup>b</sup>

<sup>a</sup> *Laboratoire de Chimie-Physique Moléculaire et Macromoléculaire (LCPMM), Faculté des Sciences de l'Ingénieur, Département de Chimie Industrielle, Université Saâd Dahlab de Blida, Route de Soumâa, B.P. 270, Blida 09000, Algeria*

<sup>b</sup> *Laboratoire de Génie Chimique, (UMR CNRS 5503) ENSIAT/INP Toulouse, 5, Rue Paulin Talabot, 31106 Toulouse, France*

## Abstract

Two sets of microemulsions, cyclohexane- and water-rich ones, were prepared with the following *n*-alkanols as cosurfactants: *n*-propanol, *n*-butanol, *n*-pentanol, and *n*-hexanol. The results showed the influence of the alkyl chain length of the *n*-alkanol on the permselectivity properties of the pervaporation technique in the breakdown of the microemulsions. The variations of the total flux rate  $J$  and the enrichment factor  $\beta$  were in parallel with the effect of the cosurfactant on the swelling extent of the PDMS membrane.

*Keywords:* *n*-Alkanol; Microemulsion; PDMS membrane; Pervaporation

## 1. Introduction

Microemulsion is a macroscopically homogeneous, thermodynamically stable, optically isotropic, transparent, and clear solution. The basic components of a microemulsion are well-known, consisting of water, oil, surfactant and cosurfactant. The use of microemulsions as reaction media and vehicles is becoming wide-spread; apart from cleansing products, oil recovery, cosmetics, lubricants and agriculture, their application has been extended to nanoparticle preparation [1], pharmaceuticals and drug delivery [2], enzymatic reactions [3], electrochemical reactions [4], and polymerization methods [5].

These thermodynamically stable and organized molecular systems are, however, sometimes difficult to break down physically, i.e. without adding a chemical, mainly because of the very low interfacial tension between oily and aqueous domains. An attempt to destabilize microemulsions was the addition of electrolytes followed by ultrafiltration (UF) but the results were not encouraging [6]. And, as it is well known, the latter separa-

tion technique suffers from a major pitfall, that is, the fouling of the membrane by the surfactant. To circumvent this drawback, we have successfully applied, with no major difficulty, the pervaporation technique, which is another membrane-separative process [7].

In the pervaporation operation, as depicted in Fig. 1, the feed mixture is maintained in contact with the upstream side of a dense membrane and the permeate (or the pervaporate) is continuously removed from the downstream side of the membrane in vapor state by a vacuum pump. The used membrane would alter the vapor-liquid equilibrium (VLE).

Several research issues have been accomplished by means of the pervaporation technique. To name but a few, there are the separation of organic components from aqueous or organic mixtures and of azeotropic binary systems [8–11], the control of oxidation of primary alcohols [12,13] and of some equilibrated reactions [14], and the breakdown of microemulsions [7,15,16]. Caron used the pervaporation technique to study the singlet oxygenation of some hydrophobic and natural substrates ( $\alpha$ -terpinene,  $\beta$ -citronellol, and  $\beta$ -pinene) in microemulsion [17]. Alcohols are most frequently used as the cosurfactants in microemulsions stabilized with ionic surfactants, affording larger curvatures (enhancement

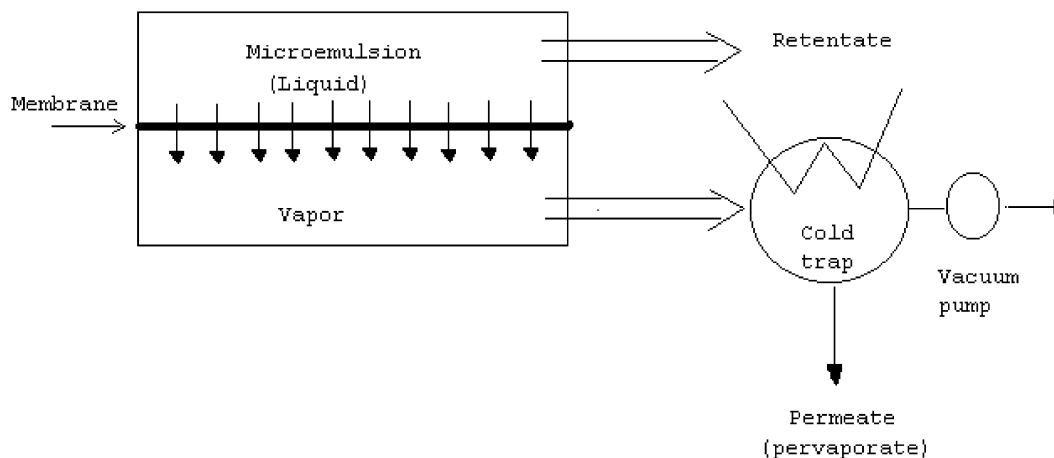

Fig. 1. Basic principles of the pervaporation technique.

of the one-phase microemulsion) and higher oil solubilization. The effects of the length of *n*-alcohols and of their isomers on microemulsion-based processes have been undertaken.

Sarma et al. reported the influence of primary and secondary alcohols on the partition equilibrium of phenol red in O/W microemulsions [18]. Savelli et al. studied the keratin cystine reactivity in function of the length of *n*-alcohol as a cosurfactant in the microemulsion medium; the longer the alkyl chain, the higher the reactivity [19]. The solubilization of water in some W/O microemulsions was examined as a function of the chain length of both the *n*-alkanes (oils) and the *n*-alkanols [20]; it was concluded that the partitioning of cosurfactant at the microemulsion droplet interface is responsible for higher water solubilization. However, Plucinski and Reitmeir [21] studied the influence of a series of *n*-alkanols ( $n = 5-12$ ) on the solubilization of phenylalanine in W/O microemulsion; the results were that the alcohols had no effect on the phenylalanine partitioning between the micellar and aqueous phases, but they have a remarked catalytic effect on its solubilization. Zhou and Rhue [22] showed the effect of the alcohol concentration on the oil solubilization (dodecane) in microemulsions, through the self-association phenomenon of alcohol.

The study of the cosurfactant effect has been extended to the microemulsion polymerization. Indeed, Puig et al. [23] reported the impact of the chain length of *n*-alkanols on the kinetics of the microemulsion polymerization of styrene; the polymerization rate decreased by addition of the alcohol in the order of *n*-butanol < *n*-hexanol < *n*-octanol, and the average-molecular weights of polystyrene were in general larger with alcohol irregardless its chain length. In another study, Herrera et al. disclosed that *n*-butanol did not affect the microemulsion polymerization rate of vinyl acetate and led to smaller average-molar masses of poly(vinyl acetate) [24].

In continuation of our work on the microemulsion breakdown by means of pervaporation [7,15,16], we wish to report the results of the effect of the chainlength of *n*-alkanols used as cosurfactants, on the permselectivity parameters.

## 2. Materials and methods

### 2.1. Chemicals

*n*-Propanol, *n*-butanol, *n*-pentanol, and *n*-hexanol in 99.5% purity were purchased from Aldrich and cyclohexane from Fluka; these chemicals were used as received. Sodium dodecyl-sulfate was provided from Prolabo and purified by recrystallization from ethanol. Water was bidistilled. Sylgard 184, a silicone elastomer (a base), and its curing agent, were supplied by Dow Corning Co.

### 2.2. Pervaporation apparatus

The pervaporation apparatus used in this work is depicted in Fig. 1. It comprised the following parts: stainless steel pervaporation cell (capacity of 120 cm<sup>3</sup>); pervaporation pyrex-made receiving set fitted with vapor traps; primary vacuum pump ( $10^{-1}-5 \times 10^{-1}$  mmHg). The condensation of the pervaporate was done by means of a liquid nitrogen.

### 2.3. Membrane preparation

The PDMS membranes were prepared as follows: Sylgard, in an amount suitable for making a 125  $\mu$ m thick membrane, was mixed with the thermal curing agent at 10:1 mass ratio. After a good homogenization, this mixture was poured and spread evenly over a clean glass plate surface by means of an appropriate applicator. A transparent film was peeled off after exposure of the plate to a curing temperature of 160 °C (oven) for 30 min. The thickness of the membrane was estimated to be  $125 \pm 1$   $\mu$ m with a micrometer.

The morphology of the PDMS membrane was viewed using scanning electronic microscopy (SEM), LEO 435 VP type. Fig. 2 illustrates the morphology of PDMS membrane before and after swelling process.

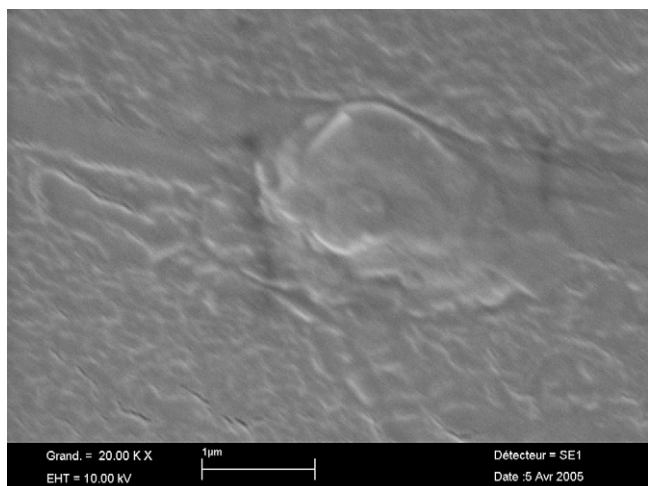

(a)

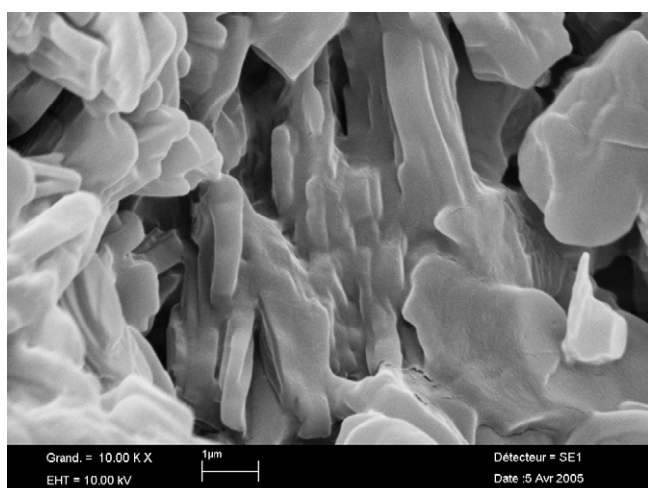

(b)

Fig. 2. SEM micrograph of the PDMS membrane: (a) non-swollen state, (b) swollen state (by cyclohexane).

Table 1  
Compositions of the microemulsions (wt%)

Microemulsion	Cyclohexane	Water	SDS	<i>n</i> -Alkanol
System I	69.00	2.50	9.50	19.00
System II	6.35	20.00	24.55	49.10

#### 2.4. Microemulsions characterization

Eight microemulsions (water-borne and cyclohexane-rich ones) were formulated according to the procedure described in the literature [25], with compositions shown in Table 1.

The conductivities ( $\kappa$ ) of the microemulsions were measured at 25 °C with conductometer 702 fitted with a Knick-type measuring four-poles cell and an integrated temperature probe.

The tests for the microemulsion nature, i.e. tests with methylene blue and a cobalt-chloride-impregnated filter paper, were performed as described earlier [15].

Microemulsion viscosities were recorded at room temperature using Carr-med rheometer CSL 500, with a shear rate  $d\gamma/dt$  varying in the range of 1–700  $s^{-1}$ .

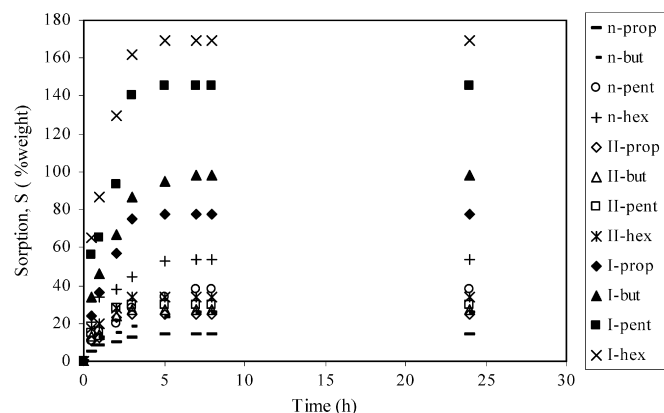

Fig. 3. Plot of the variation of the swelling extent  $S$  (wt%) of the PDMS membrane in the different *n*-alkanols, the system I microemulsions, and the system II microemulsions.

The droplets size of microemulsions were determined by photons correlation spectroscopy (PCS) using a Malvern-type Nanosizer (Zetasizer nano). The droplet mean-diameter was computed by the Stokes–Einstein’s law:  $R_H = k_B T / (6\pi\eta D)$ , where  $R_H$ ,  $k_B$ ,  $T$ ,  $\eta$ , and  $D$  are hydrodynamic radius of the droplet, Boltzmann’s constant, temperature in Kelvin, viscosity of the microemulsion, and diffusion constant, respectively.

The swelling degrees of the membrane with the different alcohols and their corresponding microemulsions were determined by Eq. (1) and illustrated in Fig. 3.

$$S (\%) = \left[ \frac{w - w_0}{w_0} \right] \times 100, \quad (1)$$

where  $w_0$  and  $w$  are the sample weight before and after swelling.

#### 2.5. Pervaporative parameters

The liquid permeate was analyzed by gas chromatography using Thermofinnigan autosampler AS 3000 with the following parts: FID, capillary column (Nukol-type), nitrogen as a carrier gas, Carbowax 20M as a stationary phase, column (2 m in length, 3.17 mm in diameter); injection port temperature, 160 °C, column temperature, 120 °C, and detector-port temperature, 200 °C.

The total mass flux rate or permeate flux  $J$  was provided by equation

$$J (\text{g}/(\text{h}\text{m}^2)) = \frac{W}{tA}, \quad (2)$$

where  $W$  is the weight of the condensate (g) (the condensate may contain a minute amount of water, besides oil and alcohol),  $t$  the trapping time (h) and  $A$  the surface area of the membrane ( $\text{m}^2$ ); the surface area of the membrane was 29.50  $\text{cm}^2$ . The enrichment factor  $\beta$  is estimated from the following relation:

$$\beta = \frac{C_i(\text{pervaporate})}{C_i(\text{retentate})}, \quad (3)$$

where  $C_i(\text{pervaporate})$  and  $C_i(\text{retentate})$  are the weight fractions (%) of the breakdown-affecting component (oil) in the

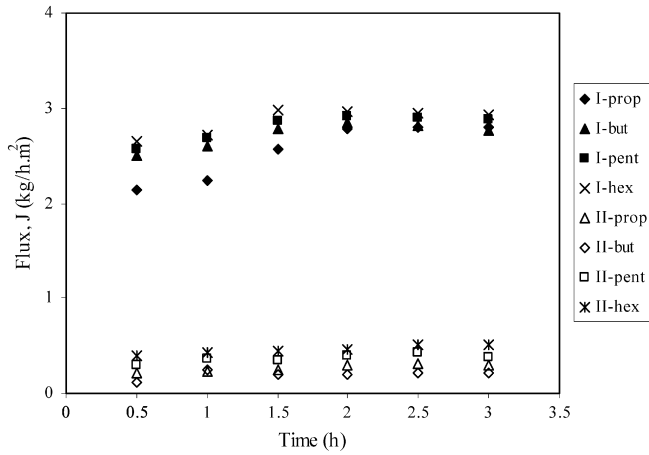

Fig. 4. Plots of the variation of the flux rate  $J$  ( $\text{kg}/(\text{h m}^2)$ ) for systems I and II microemulsions vs time. The working temperature was  $25^\circ\text{C}$ .

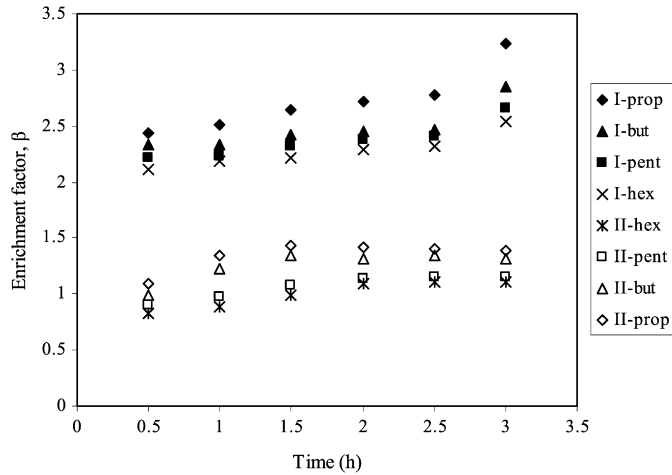

Fig. 5. Plots of the variation of the enrichment factor  $\beta$  for systems I and II microemulsions vs time. The working temperature was  $25^\circ\text{C}$ .

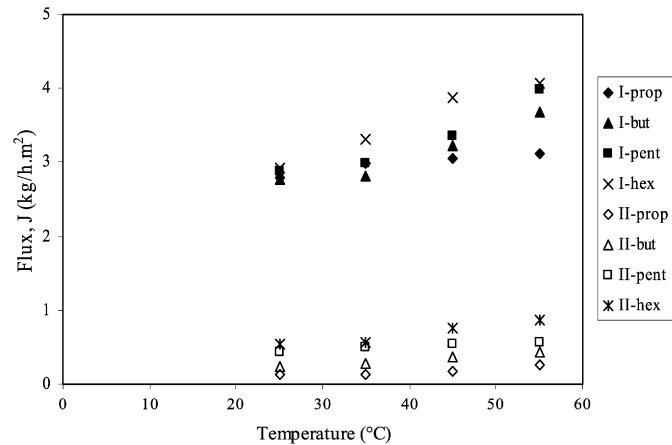

Fig. 6. Plots of the variation of the flux rate  $J$  ( $\text{kg}/(\text{h m}^2)$ ) for systems I and II microemulsions vs temperature. The operation time was 3 h.

permeate and the feed, respectively. Results of the variations of both the flux rates and the enrichment factors with time and with temperature are illustrated in Figs. 4–8. The concentrations  $C_i$ 's of the oil in the pervaporate and in the retentate

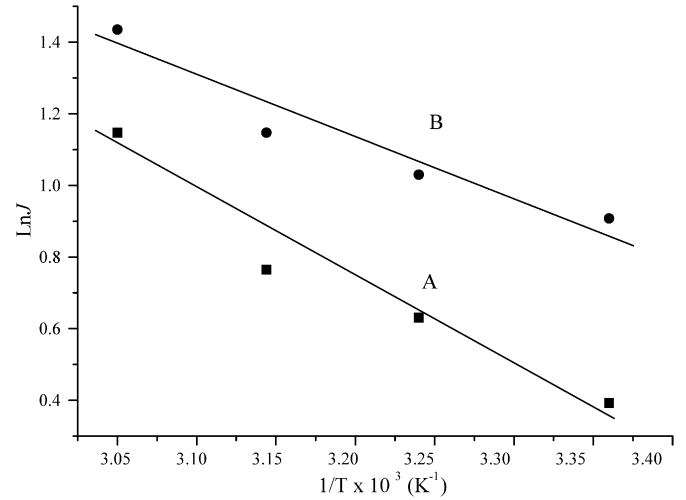

Fig. 7. Arrhenius plots  $\ln J = f(1/T)$ : A for  $I_{\text{prop}}$ ; B for  $I_{\text{hex}}$ .

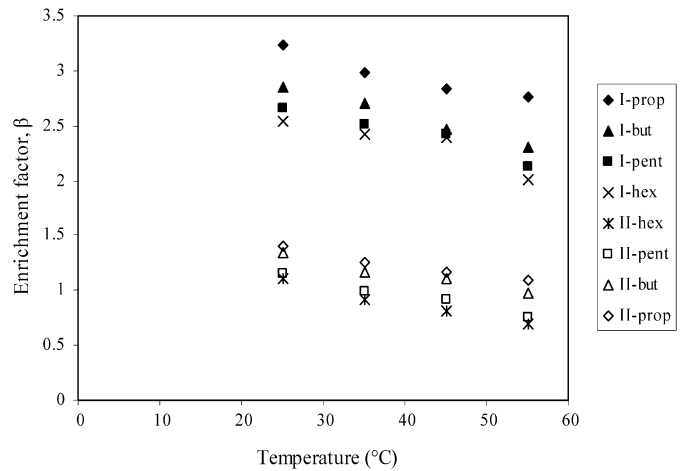

Fig. 8. Plots of the variation of the enrichment factor  $\beta$  for systems I and II microemulsions vs temperature. The operation time was 3 h.

were estimated as follows: the weight of the oil in the pervaporate  $W_{\text{oil}}(\text{perv})$  was calculated as:  $W_{\text{oil}}(\text{perv}) = W_{\text{per}} - W_{\text{alc}}(\text{perv})$  where  $W_{\text{per}}$  and  $W_{\text{alc}}(\text{perv})$  were the weights of the pervaporate and the alcohol in the pervaporate, respectively (assuming  $W_{\text{water}}(\text{perv})$  negligible), hence  $C_i(\text{pervaporate})$ .  $W_{\text{alc}}(\text{perv})$  was estimated from gas chromatography.  $W_{\text{oil}}(\text{ret})$  and  $W_{\text{alc}}(\text{ret})$  were then determined as  $W_{\text{oil}}(\text{feed}) - W_{\text{oil}}(\text{perv})$  and  $W_{\text{alc}}(\text{feed}) - W_{\text{alc}}(\text{perv})$ , respectively;  $W_{\text{oil}}(\text{feed})$  and  $W_{\text{alc}}(\text{feed})$  are the initial weights of the oil and alcohol in the feed. The weights of water and SDS were almost unchanged during the pervaporation operation, hence  $C_i(\text{retentate})$  can be computed.

### 3. Results and discussion

#### 3.1. Microemulsions

Four water-borne microemulsions (systems I) and four cyclohexane-rich ones (systems II) were made with  $n$ -alkanols of increasing alkyl chain length (Table 1), that is, from  $n$ -propanol to  $n$ -hexanol. The weight ratio cosurfactant/surfactant



Table 2  
Characteristics of the microemulsions<sup>a</sup>

	I <sub>1</sub> -prop	I <sub>1</sub> -but	I <sub>1</sub> -pent	I <sub>1</sub> -hex	II <sub>1</sub> -prop	II <sub>1</sub> -but	II <sub>1</sub> -pent	II <sub>1</sub> -hex
$\kappa$ (mS/cm)	132	98.7	52.5	20.3	285	235	226	198
$\phi$ (nm)	20–30	22–35	25–40	40–50	10–35	20–40	25–55	20–55
$\eta$ (mPa S)	2.35	2.56	2.78	2.98	3.21	3.56	3.65	3.89
Nature	O/W/O	O/W/O	O/W/O	O/W/O	W/O/W	W/O/W	W/O/W	W/O/W

<sup>a</sup>  $\kappa$ ,  $\phi$ , and  $\eta$  are the conductivity at 25 °C, the droplet mean-diameter, and the dynamic viscosity of the microemulsion at 25 °C, respectively.

(*n*-alkanol:SDS) was maintained at 2 as most authors suggested. The different physico-chemical tests confirmed the O/W/O and W/O/W natures for systems I and II, respectively. As can be noticed in Table 2, the conductivities of the former systems were significantly lower than those of latter systems; an oil-rich microemulsion is less conductive than a water-rich one. More interestingly, the conductivity ( $\kappa$ ) decreased with increasing chain length of alkanol. For example, in systems II, the conductivity of the microemulsion II<sub>1</sub>-prop was 285 mS/cm but that of II<sub>1</sub>-hex was 198 mS/cm, nearly 100 mS/cm lower. The dielectric constants  $\epsilon$  of the alkanols and their Reichardt–Dimroth parameter  $E_T^N$  (the normalized  $E_T$ ), the solvent polarity parameter, would account for the conductivity differences of the corresponding microemulsions; the higher the  $\epsilon$  and  $E_T$ , the greater is  $\kappa$ . The dielectric constants of *n*-alkanols at 25 °C [26] and their Reichardt–Dimroth parameter [27] are as follows: *n*-propanol ( $\epsilon = 20.33$ ;  $E_T^N = 0.617$ ), *n*-butanol (17.5; 0.602), *n*-pentanol (13.9; 0.568), and *n*-hexanol (13.3; 0.559).

The microemulsions of system II were about 1.34 more viscous than those of system I and, in general, the dynamic viscosity of a microemulsion  $\eta$  increased with alkyl chain length of the alcohol. The viscosities were in the range of 2.35–2.98 and 3.31–3.89 mPa S for systems I and II, respectively.

However, the alkyl chain length of the alkanol had a slight effect on the droplet size of the microemulsion; those with *n*-hexanol were of a greater size than those with *n*-propanol. Yet, the droplet mean-diameter  $\phi$  fluctuated generally between 10 and 55 nm.

### 3.2. Sorption study

One of the basic criteria of a membrane designed for a pervaporation purpose is its substantial density. SEM micrograph shown in Fig. 2a reveals how dense was the freshly prepared PDMS membrane, used in this study; no pores were apparent and detected. After swelling by cyclohexane, a change of its internal morphology is clear as shown in Fig. 2b. The sorption results are given in Fig. 3. It can be deduced that the different alcohols are not good swelling agents for the PDMS membrane; indeed, an optimal swelling degree of about 60% was observed at a temperature of 25 °C and after 5 h. However, the sorption extent is function of the alcohol length: *n*-hexanol (54%) > *n*-pentanol (38%) > *n*-butanol (25%) > *n*-propanol (14%). The alcohol of a longer alkyl chain is more hydrophobic, thus more miscible with PDMS membrane, which is known for its greater organophilicity. The trend in the sorption of *n*-alkanols by PDMS membrane is in tune with their solubility parameters,  $\delta^*$ s:  $\delta_{n\text{-hexanol}}$  (9.97 (cal cm<sup>3</sup>)<sup>1/2</sup>),  $\delta_{n\text{-pentanol}}$  (11.92),  $\delta_{n\text{-butanol}}$

(11.40),  $\delta_{n\text{-propanol}}$  (11.92),  $\delta_{\text{PDMS}}$  (7.3) [28]. The lower the solubility parameter difference  $\Delta\delta$ , ( $\Delta\delta = |\delta_{\text{PDMS}} - \delta_{\text{alcohol}}|$ ), the greater the miscibility, thus the better the swelling of the membrane [29].

By comparison of the sorption curves of Fig. 3, one can deduce that microemulsions of system I swelled the PDMS membrane remarkably better than those of system II; for example, a sorption of about 170% of I<sub>1</sub>-hex was gained after 5 h and at a temperature of 25 °C, and only 35% for II<sub>1</sub>-hex under the same working conditions. This difference in sorptions owes to the nature difference of the microemulsions of systems I and II: in I, cyclohexane has a great affinity with PDMS membrane (about 250% swelling), and in II, water has no affinity with membrane (swelling nil) [30]. That is, cyclohexane would raise the swelling ability of the microemulsion, and water would oppositely reduce it. To recall, the solubility parameter of PDMS is closer to that of cyclohexane ( $\delta_{\text{cyclohexane}} = 8.2$  (cal cm<sup>3</sup>)<sup>1/2</sup>) and substantially lower than that of water (22.6 (cal cm<sup>3</sup>)<sup>1/2</sup>) [28]. Again, the increasing order of swellings of PDMS membrane by the microemulsions is as follows: I<sub>1</sub>-prop < I<sub>1</sub>-but < I<sub>1</sub>-pent < I<sub>1</sub>-hex and II<sub>1</sub>-prop < II<sub>1</sub>-but < II<sub>1</sub>-pent < II<sub>1</sub>-hex.

The larger the alkyl chain, the less polar the alcohol and, consequently, the greater the sorption.

### 3.3. Pervaporation study

The pervaporation operation was effective in inducing the microemulsion breakdown leading to the separation of its components. The breakdown-promoting constituent is the one that has a substantial affinity to the PDMS membrane, according to its sorption extent. In the present study, cyclohexane, the oily component of the microemulsions, was preferentially transported through the membrane, inducing the disruption of the systems. In fact, an optimal volume was required for the collapse of a microemulsion, resulting in a cloudiness [7].

The permselectivity parameters of the pervaporation process, the total flux rate  $J$  and the enrichment factor  $\beta$ , were experimentally determined for both systems I and II. More accurately, the study of the effect of the cosurfactant on the variations of  $J$  and  $\beta$  with time and temperature was undertaken.

#### 3.3.1. Effect of time

Fig. 4 illustrates the variations of the total flux rate with time for systems I and II. It is clear that the longer the alkyl chain of the alcohol, the greater the total flux. The better affinity of *n*-hexanol with PDMS membrane would account for this result; its relatively higher organophilic character contributes to the breakdown of the microemulsion, and henceforth, accelerates

the transport of cyclohexane. It is interesting to notice that for systems I,  $J$  increased within the first 90 min and leveled off beyond a value of 2.8 and 2.93 kg/(h m<sup>2</sup>) for *n*-propanol and *n*-hexanol, respectively, but it decreased for systems II starting at 0.301 and 0.333 kg/(h m<sup>2</sup>) for these alcohols. The total flux rates for systems I were found nine-fold those for systems II, plausibly because of the organophilic character of PDMS membrane. The effect of the alcohol chain length on  $J$  manifested mostly within the first 90 min of the three-hour operation for systems I.

Fig. 5 displays the variations of the enrichment factor with time for systems I and II. The enrichment factors for systems I were about twice those for systems II. However, the impact of the nature of the cosurfactant was that there was a reverse effect to the flux rates,  $\beta$  decreased with alcohol chain length for both systems. On the other hand, a slight rise of  $\beta$  was observed within 2 h of operation, followed by stable values of 2.813 and 1.46 for *n*-propanol and, 2.39 and 1.21 for *n*-hexanol.

### 3.3.2. Effect of temperature

Fig. 6 shows the variations of the total flux rates with temperature, maintaining the operation time at 3 h, for systems I and II. On the contrary to variations of  $J$  with time, a sharp increase with temperature was found for both systems. Also  $J$  was found to rise with the chain length of the cosurfactant. For a 20 °C increase, about the flux increased by 1.99 and 0.14 kg/(h m<sup>2</sup>) for *n*-propanol and, 1.63 and 0.07 kg/(h m<sup>2</sup>) for *n*-hexanol, for systems I and II, respectively. Again, the total fluxes for the first systems were generally lower than those for the second ones, owing to the oil-richness difference in these systems. From the Arrhenius plots of  $\ln J = f(1/T)$  (Fig. 7) the activation energy  $E_a$  was found to be 20.24, 17.83, 14.32, and 9.20 kJ/mol for I<sub>1-prop</sub>, I<sub>1-but</sub>, I<sub>1-pent</sub>, and I<sub>1-hex</sub>, respectively. The activation energy results indicate that the pervaporation performance should be in the following order: I<sub>1-prop</sub> < I<sub>1-but</sub> < I<sub>1-pent</sub> < I<sub>1-hex</sub>. It is worthy to recall [16] that the microemulsions in the feed became turbid at temperatures higher than 45–50 °C after 3 h operation; however, for lower temperatures, this cloudiness appeared after 24 h.

Fig. 8 illustrates the effect of temperature on the enrichment factor  $\beta$  for systems I and II. A decrease of  $\beta$  with temperature was generally observed and, the reverse effects of the cosurfactants, as compared to the variation of the flux rate were noted for the systems in question. For a 20 °C temperature increase,  $\beta$  declined from 3.25 to 2.55 for I<sub>1-prop</sub>, and from 2.51 to 2.00 for I<sub>1-hex</sub>. For the corresponding systems II, the drop was from 1.30 to 1.18 and from 1.00 to 0.82, respectively.

## 4. Conclusions

Pervaporation proved to be a powerful technique in the breakdown of a microemulsion, well known as a highly or-

dered system. One of the factors affecting the permselectivity properties of the pervaporation when applied in the collapse of a microemulsion, is the alkyl chain length of *n*-alcohol used as a cosurfactant; alcohol with a longer alkyl chain provides better properties. Had the breakdown of a microemulsion mattered afterwards and the pervaporation been viewed as the alternative technique, the microemulsion should have preferentially been consisted of an *n*-alcohol of a longer alkyl chain.

## References

- [1] M.A. López-Quintela, J. Rivas, J. Colloid Interface Sci. 158 (2005) 446.
- [2] S. Peltola, P. Saarinen-Savolainen, J. Kiesvaara, T.M. Suhonen, A. Urretzi, Int. J. Pharm. 254 (2003) 99.
- [3] Y.L. Khmel'nitsky, R. Hilhorst, A. Visser, C. Veeger, Eur. J. Biochem. 211 (1993) 73.
- [4] J.M. Rusling, Pure Appl. Chem. 73 (2002) 1895.
- [5] C.C. Co, R. De Vries, E.W. Kaler, in: J. Dexter (Ed.), Reactions and Synthesis in Surfactant Systems, in: Surfactants Science Series, vol. 100, Marcel Dekker, New York, 2001.
- [6] C. Yang, Ph.D. thesis, INP de Toulouse, France, 1993.
- [7] T. Aouak, S. Moulay, A. Hadj-Ziane, J. Membr. Sci. 173 (2000) 149.
- [8] R.Y.M. Huang, C.K. Yeom, J. Membr. Sci. 58 (1991) 33.
- [9] S. Moulay, T. Aouak, A. Hadj-Ziane, F. Rouabah, M. El-Mahdi, J. Soc. Alg. Chim. 10 (2000) 89.
- [10] A. Jonquière, R. Clément, P. Lochon, M. Dresch, B. Chrétien, J. Membr. Sci. 206 (2002) 87.
- [11] H.E.A. Brütshcke, in: S.P. Nunes, K.V. Peinemann (Eds.), State of the Art of Pervaporation Processes in the Chemical Industry, in: Membrane Technology in the Chemical Industry, Wiley-VCH, Weinheim, 2001.
- [12] H. Benguergoura, T. Aouak, S. Moulay, J. Membr. Sci. 229 (2004) 107.
- [13] S. Moulay, H. Benguergoura, T. Aouak, J. Chromatogr. A 1135 (2006) 78.
- [14] N. Wynn, Chem. Eng. Prog. 97 (2001) 66.
- [15] A.Z. Hadj-Ziane, S. Moulay, Desalination 170 (2004) 91.
- [16] S. Moulay, A. Hadj-Ziane, N. Bensacia, Sep. Purif. Technol. 44 (2005) 181.
- [17] L. Caron, V. Nardello, J. Mugge, E. Hoving, P.L. Alsters, J.-M. Aubry, J. Colloid Interface Sci. 282 (2005) 478.
- [18] S. Sarma, M. Bora, R.K. Dutta, Colloids Surf. A 256 (2005) 105.
- [19] P.P. Savelli, C. Solans, R. Pons, M. Clausse, P. Erra, Colloids Surf. A 119 (1996) 155.
- [20] Y. Bayrak, Colloids Surf. A 247 (2004) 99.
- [21] P. Plucinski, J. Reitmeyer, Colloids Surf. A 97 (1995) 157.
- [22] M. Zhou, R.D. Rhue, J. Colloid Interface Sci. 228 (2000) 18.
- [23] J.E. Puig, E. Mendizábal, S. Degado, J. Arellano, F. López-Serrano, C.R. Chimie 6 (2003) 1267.
- [24] J.R. Herrera, R.D. Peralta, R.G. López, L.C. Cesteros, E. Mendizábal, J.E. Puig, Polymer 44 (2003) 1795.
- [25] C. Bourayne, M.T. Maurette, E. Pliveros, M. Riviere, A. Savignac, A. Lattes, J. Chim. Phys. 79 (1982) 139.
- [26] J.A. Dean, Lange's Handbook of Chemistry, 13th ed., McGraw-Hill, New York, 1985.
- [27] C. Reichardt, Solvents and Solvent Effect in Organic Chemistry, third ed., Wiley-VCH, New York, 2003.
- [28] J. Bandrup, E.H. Immergut, Polymer Handbook, third ed., Wiley, New York, 1998.
- [29] B. Smitha, D. Suhanya, S. Sridhar, M. Ramakrishna, J. Membr. Sci. 241 (2004) 1.
- [30] A. Hadj-Ziane, S. Moulay, J.-P. Canselier, J. Chromatogr. A 1091 (2005) 145.