



HAL
open science

Monitoring of the Aggregation Process of Dense Colloidal Silica Suspensions in a Stirred Tank by Acoustic Spectroscopy

Mallorie Tourbin, Christine Frances

► **To cite this version:**

Mallorie Tourbin, Christine Frances. Monitoring of the Aggregation Process of Dense Colloidal Silica Suspensions in a Stirred Tank by Acoustic Spectroscopy. Powder Technology, 2008, pp.0. 10.1016/j.powtec.2008.04.067 . hal-03591046

HAL Id: hal-03591046

<https://hal.science/hal-03591046>

Submitted on 28 Feb 2022

HAL is a multi-disciplinary open access archive for the deposit and dissemination of scientific research documents, whether they are published or not. The documents may come from teaching and research institutions in France or abroad, or from public or private research centers.

L'archive ouverte pluridisciplinaire **HAL**, est destinée au dépôt et à la diffusion de documents scientifiques de niveau recherche, publiés ou non, émanant des établissements d'enseignement et de recherche français ou étrangers, des laboratoires publics ou privés.

Paper accepted for publication in Powder Technology

Monitoring of the Aggregation Process of Dense Colloidal Silica Suspensions in a Stirred Tank by Acoustic Spectroscopy

M. Tourbin, C. Frances*

*Laboratoire de Génie Chimique CNRS/INPT/UPS UMR 5503,
5, rue Paulin Talabot, BP 1301, 31106 Toulouse Cedex 01, France*

Abstract

The aim of this study is to analyze the behaviour of dense colloidal suspensions in flow by acoustic spectroscopy. The destabilization and the aggregation of stable colloidal silica dispersions in a stirred tank are obtained by addition of salt.

Experiments were made in order to observe the influence of different operating parameters, like silica concentration, temperature and stirring speed, on the behaviour of the suspended particles.

The use of online acoustic spectroscopy to analyse the process enables us to evaluate the evolution of the silica suspension properties during the aggregation processes. For example, the influence of physicochemical and hydrodynamics parameters on the aggregation process can be simply explained on the basis of the acoustic attenuation spectra. Thus the direct analysis of the spectra can give information on the evolution of the aggregation process and a fast comparison of the effects of the various operational parameters.

*Corresponding author.
Christine.Frances@ensiacet.fr (C. Frances)

Keywords: acoustic spectroscopy, nanoparticles, dense suspensions, aggregation, online characterization.

1. Introduction

The success of nanoparticles is due to their use in a wide range of industrial applications in the chemical, pharmaceutical, cosmetic industries, etc. The industrially useful properties of nanoparticles (optical properties, texture, rheological behaviour, bioavailability ...) in the form of powders or suspensions are closely related to the particle size and to their dispersion state.

Processing nanoparticles creates a series of problems during the generation, handling, conveying or storage steps. An inherent problem of the different methods of generation or treatment of nanoparticles in dense suspensions is the difficulty of controlling the process of aggregation and, in the long term, preserving the quality and the stability of the products.

New characterization methods for nanoparticles and the final products made of nanoparticles are needed to adapt the new methods of synthesis or treatment to this type of particle.

Principally, on-line characterization techniques are necessary for good control of the production process of the colloidal particles. The major problem for particle sizing of colloidal and dense systems during a process is that the conventional methods often require sampling and significant dilution. Uncertainties arise due to the unknown behaviour of such dense dispersions induced by the dilution step since the physicochemical and hydrodynamic conditions are changed. This gives rise to the recurrent issue of how representative the sample is. A better understanding of the aggregation phenomena would result if measurements were carried out in true processing conditions, with respect to both solid content and shear conditions.

The objective of this study is to analyze the process of aggregation of concentrated nanoparticle suspensions under flow conditions (shearing, transport), which are identical to those met in real processes, using suitable characterization methods that allow a reliable analysis of the particle size distribution in dense media. The characteristics of acoustic spectroscopy make it suitable for consideration as a solution to this problem. This characterization technique was used by some authors considering particle size variations, principally during crystallization processes [1, 2, 3, 4, 5] and gelation of dairy products [6, 7]. In this paper, measurements of the evolution of acoustic properties of colloidal silica suspensions during aggregation processes at different operating conditions are reported. Furthermore, silica suspension is a good candidate to test the possible use of ultrasonics to follow the behaviour of the particles because the suspension is constituted of spherical and relatively monodispersed particles. Such properties are involved in the main statement of the theory for acoustic data treatment.

2. Materials and Methods

2.1. Colloidal silica suspensions

A colloidal silica suspension, Klebosol 30R50 (Clariant, France), having an initial solid content of 30% w/w was used. Its density is about 1.21 g.cm^{-3} (silica density is 2.37 g.cm^{-3}) and its specific surface is around $50 \text{ m}^2.\text{g}^{-1}$. It was observed by scanning electronic microscopy that the silica particles in Klebosol 30R50 were spherical and monodispersed. Their average number diameter was roughly estimated at 80 nm. Deionized water (pH~6 and Λ ~5-7 μS) was used to prepare diluted silica suspensions from the Klebosol 30R50 initial suspension. The solid content of these suspensions was determined

with a precision of 10^{-2} % by measuring the humidity rate by thermogravimetry using a Halogen Moisture Analyser HB43 desiccation balance (Mettler Toledo) [8].

The stability and particle size of the silica suspensions have been investigated in a previous study [8]. Using dynamic light scattering, as well as measurements of pH and zeta potential, it was established that the silica suspensions remain stable and homogeneous in the range of the concentrations considered ($3\% < \text{wt.} < 20\%$). The homogeneity of the suspension is not affected by major destabilization phenomena, such as particle migration (creaming, sedimentation), particle size variation or aggregation (coalescence, flocculation).

2.2. Characterization of concentrated suspensions by acoustic spectroscopy

Acoustic spectroscopy, as a particle sizing technique, consists in measuring the acoustic attenuation spectrum of a dispersed sample (suspension or emulsion) over a given frequency range. The attenuation of the sound of the suspension provides important information, notably related to the particles size and concentration. The interaction of ultrasound waves with particles has been comprehensively described through a complete mathematical framework, known as the ECAH theory [9, 10], which accurately predicts the attenuation spectrum of a suspension taking into account three main types of particle/wave interactions: thermo-elastic, scattering and visco-inertial effects [11]. For this study, we had access to the commercial acoustic spectrometer Ultrasizer (Malvern Instruments, Ltd) that emits acoustic waves between 1 to 160 MHz. These waves have no effect on the aggregation process itself because they have a very low power, about $10 \mu\text{W}\cdot\text{cm}^{-2}$. The instrument calculates the particle size distributions through inversion to a model based on ECAH theory.

The size of the suspended particles was first measured before destabilizing the dispersed medium. The data obtained by acoustic spectroscopy is in good agreement with that given in diluted conditions using laser light diffraction (Figure 1). Indeed, the particle mean number

diameter is about 80 nm (which is in agreement with SEM observations) and the corresponding mean volume diameter is about 112 nm.

Figure 1

Furthermore, the analysis of the attenuation spectra of acoustic waves throughout the silica suspensions highlights the predominance of thermo-elastic effects due to the very small particle size. In addition, the analysis at different solid concentrations showed the existence of multiple scattering of the acoustic signal due to crowd particle effects. This phenomenon is due to the very small size and the high concentration of silica particles [8]. This results in an overlapping of the viscous and thermal skin surrounding the particles.

3. Experimental set-up and online characterization of particle behaviour

3.1 Experimental set-up for the analysis of aggregation process in a stirred tank

Aggregation experiments were carried out in a jacketed, batch agitated vessel of 1L capacity. The suspension is stirred with an A310 axial flow impeller (Lightnin). The experimental set-up also includes a thermostatic bath. (Figure 2)

600 mL of a sodium chloride solution was firstly charged into the tank and put under stirring. When the desired operating temperature was reached, 900 mL of a suspension of colloidal silica at a given concentration was added as instantaneously as possible. The initial concentrations of the sodium chloride solution and of the silica suspension were chosen in order to get the desired salt concentration and solid content after the mixing of both components.

The suspension was continuously recycled from the stirred batch reactor through the flow cell of the acoustic spectrometer using a peristaltic pump (Masterflex) that allows on-line size analysis. However, the effect of the pump on the aggregates needed to be considered. The main criterion to select the pump and to adjust the flow rate was minimum shear on the aggregates. As a result, a peristaltic pump was chosen in preference to other types of pumps. Moreover, the pump was placed downstream of the Ultrasizer, allowing the aggregates to be sampled before passing through the pump.

Figure 2

In this paper, the silica aggregation process was analyzed for given operational parameters: silica concentration, temperature and stirring speed. The different experiments that were carried out are summarized in Table 1.

Table 1

3.2. Aggregation process

For this study, the aggregation was observed in the absence of any other process, such as nucleation or particle growth. The Ultrasizer was used to quantify on-line the variation of size of the suspended particles in the process versus time. As an example, during the aggregation of Klebosol 30R50 colloidal silica diluted at 6% w/w the attenuation spectra were recorded every 30 min over a period of 8 hours. Some of these spectra are presented on Figure 3.

Figure 3

The curve at time $t = 0$ is the spectrum recorded in the initial suspension before the aggregation begins. At time $t = 60$ min, the slope of the curve has significantly decreased indicating that the particle dispersion undergoes an important destabilization phenomenon by aggregation. At further times, the change in the spectra is still observed resulting from the presence of larger aggregates, but after a certain period, the slope change is less significant indicating that the size of the aggregates does not evolve any more. It can then be supposed that the aggregation process is almost complete within 8 hours.

Taking into account the multiple scattering of the ultrasonic wave through the suspension, the particle size distributions of the suspension throughout the destabilization process were calculated [8].

Figure 4 represents the particle size distributions during this destabilization process calculated from the acoustic spectroscopy data. The evolution of the particle size distribution is consistent with an aggregation process. Indeed, the aggregation of particles is illustrated by the shift of the distributions towards the larger sizes. The evolution of the particle size distribution shows the appearance of a second population of particles after 120 min of processing, which is due to the formation of quite large aggregates, while the first peak moves gradually towards the larger sizes and decreases in intensity. It can be thought that the suspended particles are of two types: an initial population of primary particles and small aggregates, which evolves slowly and tends to disappear; a second population of large aggregates then appears after 120 min. However, the peak that corresponds to the large aggregates lacks precision. Indeed, the distribution is sensitive to the calculation parameters introduced by the experimenter (fixed or variable input for the calculation of the solid concentration, allowed minimum standard deviation on the particle size distribution, etc.). In this example, the peak of aggregates corresponds to a low volume percentage and therefore it

corresponds to a low number of particles that do not contribute enough to the total attenuation. In addition, the introduction of a correction factor to take into account the multiple scattering also contributes to the low reliability of the determined particle size distribution.

To complete this analysis, the particle size distributions were also determined in diluted conditions by laser light diffraction (after quenching into a pH 2 buffer). The PSD are represented in Figure 5. The particle aggregation is clearly illustrated again by the shift of the distribution towards the larger sizes. At the beginning of the process ($t = 0^+$), the monomodal log-normal curve of the particle size distribution has a mean size of 112 nm. During the first period, the mean size does not change a lot but the geometric deviation increases (the width of the distribution is increasing). Then an important change in size can be seen as aggregation proceeds once the process time exceeded 60 min: the distribution becomes bimodal.

Surprisingly, these results are in very good agreement with those determined by acoustic spectroscopy, thus leading to an important conclusion: the dilution step hardly influences, or not at all, the silica aggregates. Due to better precision, the determination of the particle size distributions during the aggregation process may be better obtained by laser light diffraction. However, the acoustic spectrometer allows on-line characterization and acoustic spectra which can be interpreted in order to give precious information during a continuous process.

Figure 4

Figure 5

4. Influence of the operating conditions on the aggregation processes

The silica aggregation process was analyzed for different physicochemical (silica concentration, temperature) and hydrodynamic (stirring speed) parameters.

4.1. Silica concentration

The influence of silica concentration on the aggregation process was studied by varying the silica solid content $[\text{SiO}_2] = 3; 6; 10; \text{ or } 20\%$ w/w, keeping the other conditions constant: $[\text{NaCl}] = 0.8 \text{ mol.L}^{-1} / T = 25^\circ\text{C} / \text{ stirring speed} = 450 \text{ rpm}$.

Figure 6 represents the attenuation spectra at initial ($t = 0$) and final ($t = 8 \text{ hrs}$) times of the aggregation process for the different silica suspensions. It can be observed that the initial attenuation spectra are all parallel. A change of the gradient of the spectrum is proof of a change in the suspended particle size. Whatever the solid content considered, the gradients of the final spectra ($t = 8 \text{ hrs}$) highlight the existence of an aggregation process. The gradients of the curves for the experiments at 6% and 10% w/w are quite similar. This similarity proves that the stationary states obtained during these three experiments are not different regarding the final particle size. The gradient of the spectrum for the 3% w/w suspension is higher than the others; the suspension may probably be constituted of smaller aggregates than in the solutions of higher concentrations. On the other hand, the gradient of the spectrum for the 20% w/w suspension is slightly lower than the others; in this case, the suspension may probably be constituted of slightly larger aggregates than in the solutions of lower concentrations.

For an easier comparison, Table 2 shows the calculated gradients of the curves if the attenuation spectra are comparable to log-log straight lines.

Figure 6

Table 2

The results of the laser diffraction measurements during the processes, shown in Figure 7, show that the higher the silica concentration, the faster the aggregation: the second population appears early and the aggregates are larger. Indeed, when the particle concentration increases, the collision frequency increases too.

Figure 7

4.2. Temperature

The influence of the temperature was studied in the range $T = 12; 25; 50; 65$ °C, keeping the others parameters constant: $[\text{SiO}_2] = 20\%$ w/w / $[\text{NaCl}] = 0.8 \text{ mol.L}^{-1}$ // stirring speed = 450 rpm.

Figure 8

Figure 8 represents the attenuation spectra at initial and final ($t = 8$ hrs) times of the aggregation process for the different temperatures. The attenuation spectra at $t = 0$ are parallel for the four temperatures and the higher the temperature, the higher the attenuation is for a given frequency. This behaviour can be easily explained by the effect of the temperature on the acoustic attenuation [12]. To confirm this result, measurements were performed with the Ultrasizer on stable 20% w/w suspensions of Klebosol 30R50 and for the above listed temperatures. As it can be observed in Figure 9, an increase of the temperature leads to an increase of the attenuation, which results in a translation of the spectra.

Figure 9

At the end of the process, the gradients of the curves are very different depending on the temperature considered, which proves that the steady state of the process is very different depending on temperature. For $T = 12^{\circ}\text{C}$, the gradient of the attenuation spectrum does almost not change, expressing a minor change of size and indicating that the aggregation process hardly occurs. For $T = 25^{\circ}\text{C}$, the gradient of the spectrum at the final time is very different than the initial one, indicating that the change of particle size during the process is a major one. Likewise, for $T = 65^{\circ}\text{C}$, the gradient of the spectrum is much smaller than at initial time. It can be concluded that when the temperature increases, the aggregation process is promoted and the aggregate sizes seem to be larger because of the increase in the Brownian diffusion coefficient. For a better understanding, the values of the curves slopes during those processes are summarized in Table 2.

Furthermore, it can be observed that the spectra measured at the final process time for $T = 25^{\circ}\text{C}$ and $T = 65^{\circ}\text{C}$ are very similar to one another, although the gradient of the $T = 25^{\circ}\text{C}$ spectrum is slightly smaller than for the $T = 65^{\circ}\text{C}$ spectrum. These observations, in addition with those for the processes at different silica concentrations, lead to the possible conclusion that the aggregates formed at $T = 65^{\circ}\text{C}$ are smaller than those formed at $T = 25^{\circ}\text{C}$. However, this hypothesis was refuted by the laser diffraction particle size analysis. [12] (Figure 10)

Figure 10

Another hypothesis to explain the very small difference between the slope of the curves at $T = 25^{\circ}\text{C}$ and $T = 65^{\circ}\text{C}$, and the inconsistency of the interpretation given previously on the effect

of the temperature on the aggregate size, could be that the dispersions are different with respect to the aggregate structure, which results in different behaviour of the suspension during the propagation of the acoustic waves.

4.3. Stirring speed

The influence of hydrodynamic conditions was analyzed varying the stirring speed (stirring speed = 250; 450; 690; 1120 rpm / $Re = 13280; 27000; 41400; 67200$ respectively) keeping the other conditions constant: $[SiO_2] = 20\%$ w/w / $[NaCl] = 0.8 \text{ mol.L}^{-1}$ / $T = 25^\circ\text{C}$.

At the initial time, the four spectra are the same because the suspensions are formed of suspended particles of the same size and at the same temperature (Figure 11). However, at the final time, the spectra are very different. Indeed, for a stirring speed of 1120 rpm, the spectrum remains almost constant, proving that the particle size varied a little. For the other three stirring speeds considered, the spectrum slopes change significantly during the process (Table 2), which indicates larger particle size variations. Furthermore, it can be noted that the gradients of the spectra for 250 and 450 rpm are smaller than that for 690 rpm. From these observations, it may be assumed that the lower the stirring speed, the larger the particle size is. This is due to the increase of the collision frequency when the shear rate increases (but, it must be noted that in this case the collision efficiency decreases).

Figure 11

5. Conclusion

Despite being based on different physical principles and requiring very different data analysis procedures, acoustic spectroscopy and laser light diffraction measurements lead to

comparable results. It was concluded that the silica aggregates formed during the process are affected little by the dilution process necessary when using the laser light diffraction method.. Moreover, it was demonstrated that the acoustic spectroscopy analysis gives interesting information, even if it does not lead to precise PSD results for Klebosol 30R50. The influence of physicochemical and hydrodynamics parameters on the aggregation process can simply be explained on the basis of the acoustic attenuation spectra. Thus the direct analysis of the spectra can give information on the kinetics of the aggregation process and a fast comparison of the effects of the various operational parameters on aggregation.

7. Acknowledgements

The authors gratefully acknowledge R. Tweedie and M. Terray from Malvern Instruments for their scientific support on acoustic spectroscopy analysis. The authors are also very grateful for the local support of the cooperative structure of joint research FERMaT (Toulouse, France).

8. References

- [1] Marshall T., Tebbut J.S., Challis R.E., Monitoring the crystallization from solution of a reactive dye by ultrasound, *Measurement Science and Technology*, 11, 509-517, (2000).
- [2] Hipp A.K., Walker B., Mazzotti M., Morbidelli M., In-Situ Monitoring of Batch Crystallization by Ultrasound Spectroscopy, *Ind. Eng. Chem. Res.*, 39(3), 783-789, (2000).
- [3] Mougín P., Wilkinson D., Roberts K.J., In Situ Measurement of Particle Size during the Crystallization of L-Glutamic Acid under Two Polymorphic Forms: Influence of Crystal Habit on Ultrasonic Attenuation Measurements, *Crystal Growth and Design*, 2(3), 227-234, (2002).
- [4] Lyall E., Mougín P., Wilkinson D., Roberts K.J., In Situ Ultrasonic Spectroscopy Study of

- the Nucleation and Growth of Copper Sulfate Pentahydrate Batch Crystallized from Supersaturated Aqueous Solutions, *Ind. Eng. Chem. Res.*, 43(16), 4947-4956, (2004).
- [5] Li M., Wilkinson D., Patchigolla K., Mouglin P., Roberts K.J., Tweedie R., On-Line Crystallization Process Parameter Measurements Using Ultrasonic Attenuation Spectroscopy, *Crystal Growth and Design*, 4(5), 955-963, (2004).
- [6] Corredig M., Alexander M., Dalgleish D.G., The application of ultrasonic spectroscopy to the study of the gelation of milk components, *Food Research International*, 37(6), 557-565, (2004).
- [7] Dalgleish D., Alexander M., Corredig. M., Studies of the acid gelation of milk using ultrasonic spectroscopy and diffusing wave spectroscopy, *Food Hydrocolloids*, 18(5), 747-755, (2004).
- [8] Tourbin M., Frances C., A survey of Complementary Methods for the Characterization of Dense Colloidal Silica, *Particle and Particle System Characterization*, *In Press*.
- [9] Epstein P.S., Carhart R.R., The absorption of sound in suspensions and emulsions. I. Water fog in air, *Journal of Acoustic Society of America*, 25, 553-565, (1953).
- [10] Allegra J.R, Hawley S.A, Attenuation of Sound in Suspensions and Emulsions: Theory and Experiments, *Journal of Acoustic Society of America*, 51 (5 part 2), 1545 – 1564, (1972).
- [11] Dukhin A.S., Goetz P.J., New developments in acoustic and electroacoustic spectroscopy for characterizing concentrated dispersions, *Colloids and Surfaces A: Physicochemical and Engineering Aspects*, 192, 267-306, (2001).
- [12] Tourbin M., Caractérisation et comportement de suspensions concentrées de nanoparticules sous écoulement : Application aux processus d'agrégation et de rupture, *Thèse de Doctorat, Institut National Polytechnique de Toulouse*, (2006).

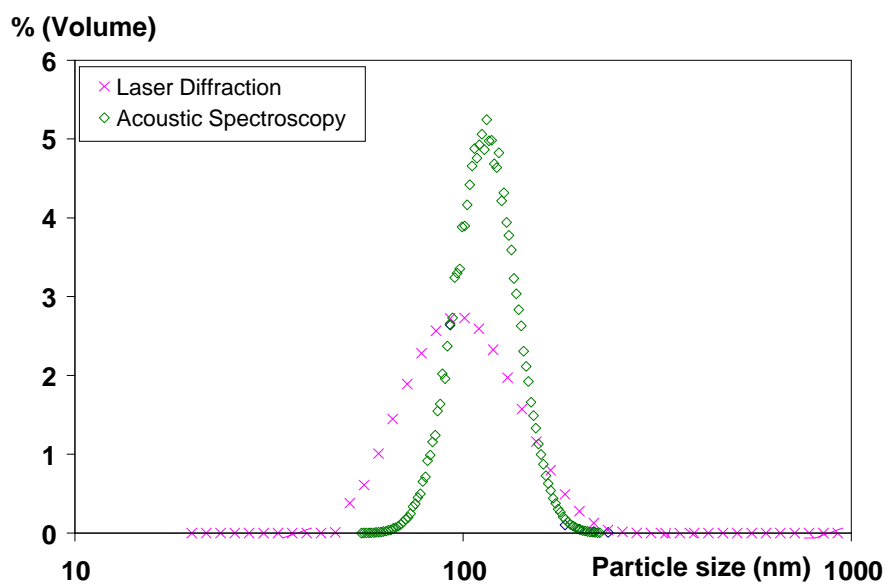

Figure 1: Comparison of volume frequency distributions measured by laser diffraction and acoustic spectroscopy (10 % wt. suspension).

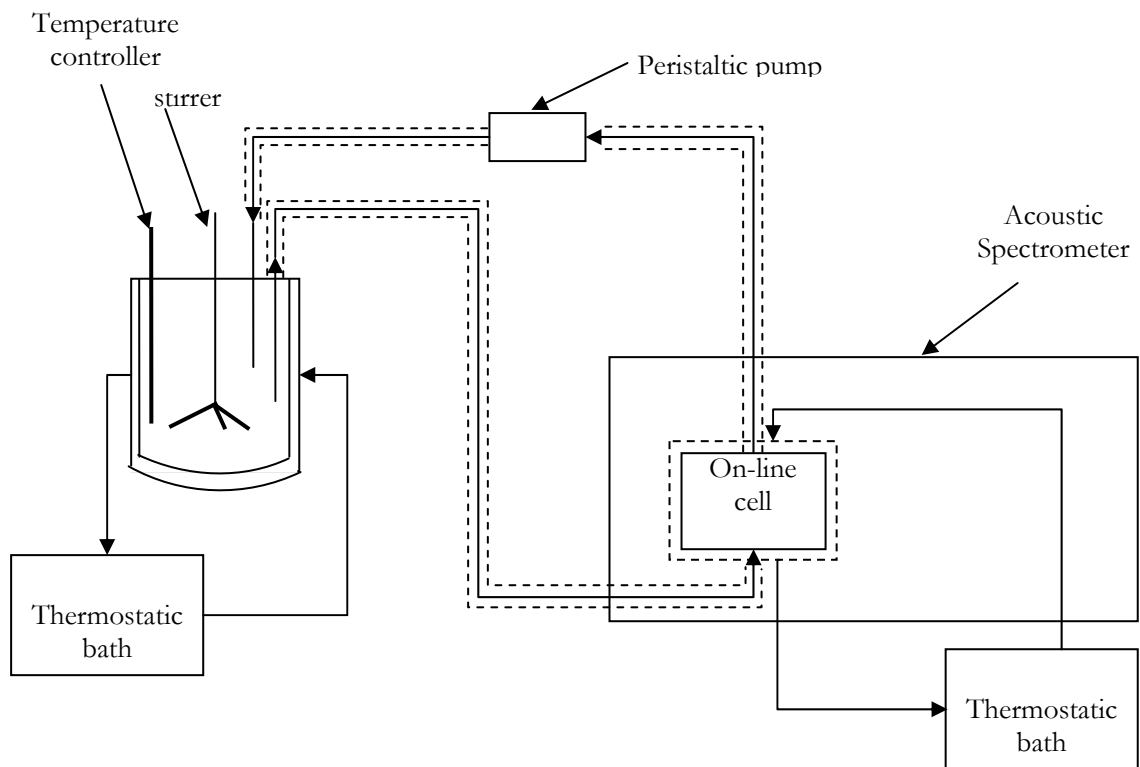

Figure 2: Experimental set-up

Experiment	[SiO ₂] (% wt.)	[NaCl] (mol.L ⁻¹)	Temperature (°C)	Stirring speed (rpm)
1	3	0.8	25	450
2	6	0.8	25	450
3	10	0.8	25	450
4	20	0.8	25	450
5	20	0.8	12	450
6	20	0.8	50	450
7	20	0.8	65	450
8	20	0.8	25	690
9	20	0.8	25	1120

Table 1: Parameters of the experiments of the destabilization of silica suspensions by salt addition.

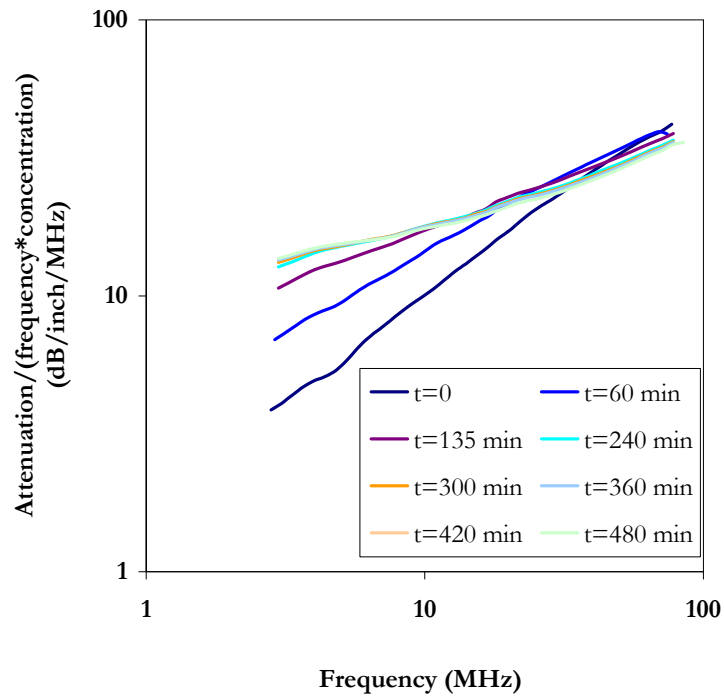

Figure 3: Attenuation spectra measured by on-line acoustic spectroscopy in dense conditions of the aggregation process. $[\text{SiO}_2] = 6\% \text{ w/w}$ / $[\text{NaCl}] = 0.8 \text{ M}$ / $T = 25^\circ\text{C}$ / stirring speed = 450 rpm.

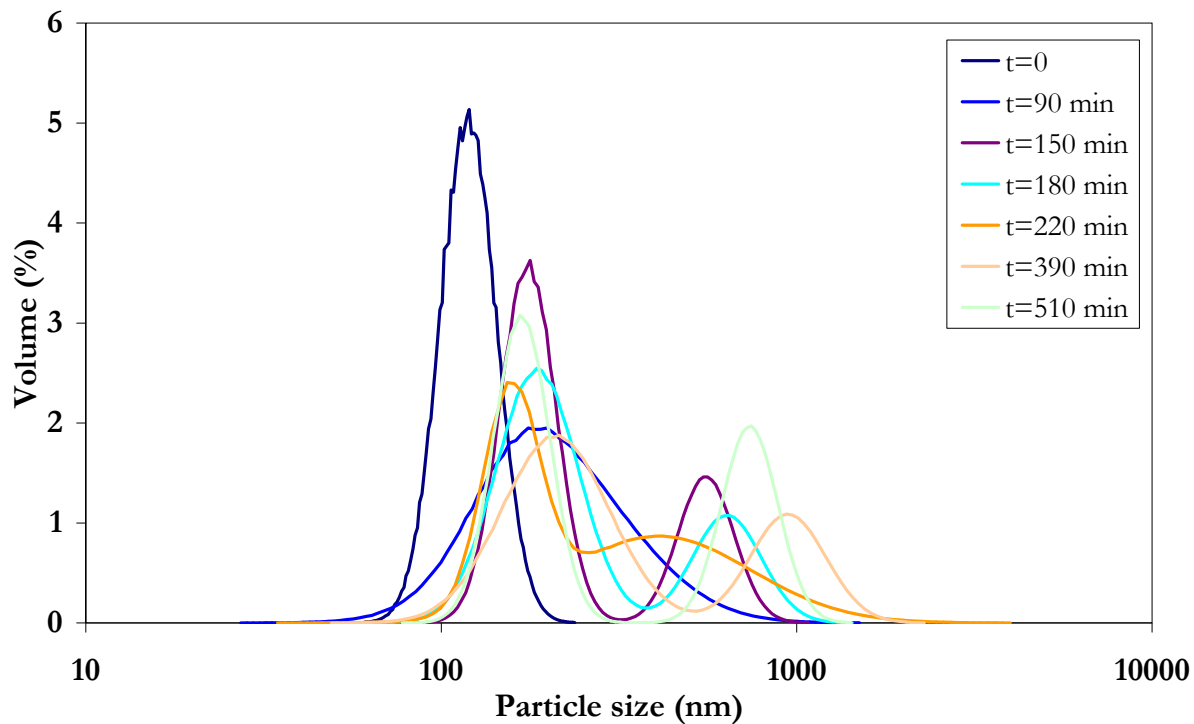

Figure 4: Particle size distribution measured by on-line acoustic spectroscopy in dense conditions of the aggregation process. $[\text{SiO}_2] = 6\% \text{ w/w}$ / $[\text{NaCl}] = 0.8 \text{ M}$ / $T=25^\circ\text{C}$ / stirring speed = 450 rpm.

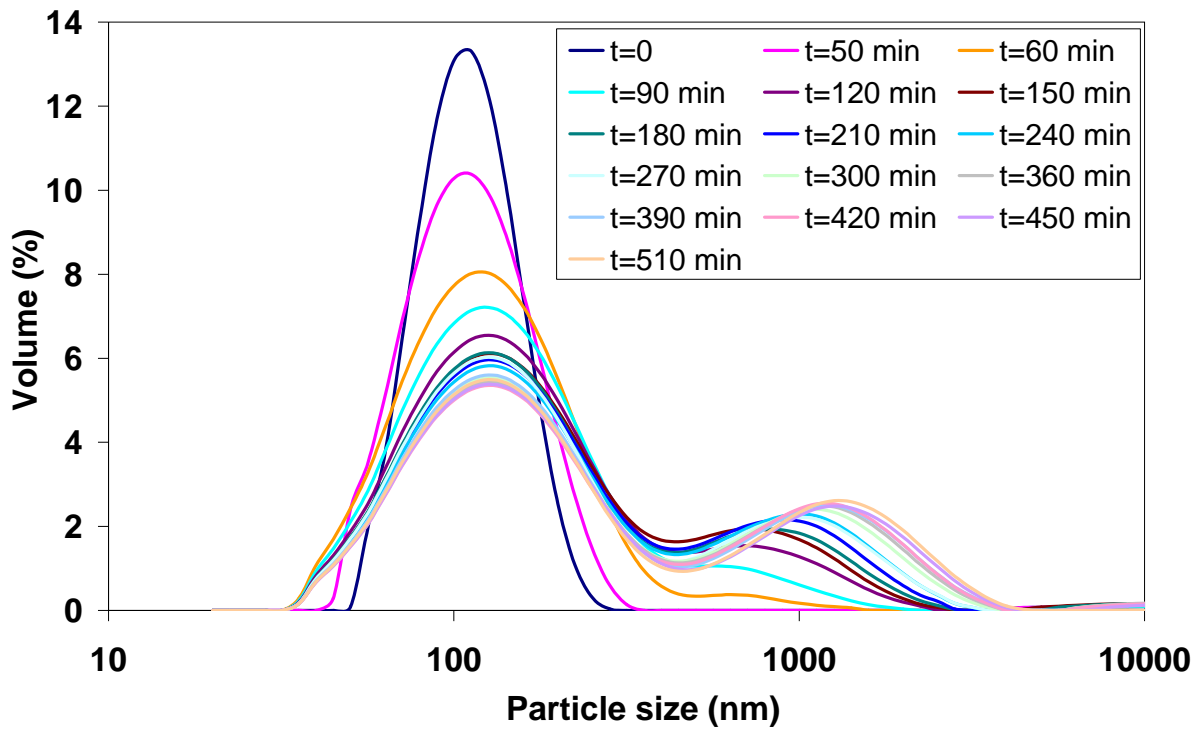

Figure 5: Particle size distribution measured by laser diffraction. Samples of the suspensions taken during the aggregation process are diluted. $[\text{SiO}_2] = 6\% \text{ wt.} / [\text{NaCl}] = 0.8 \text{ M} / T = 25^\circ\text{C} / \text{stirring speed} = 450 \text{ rpm}$.

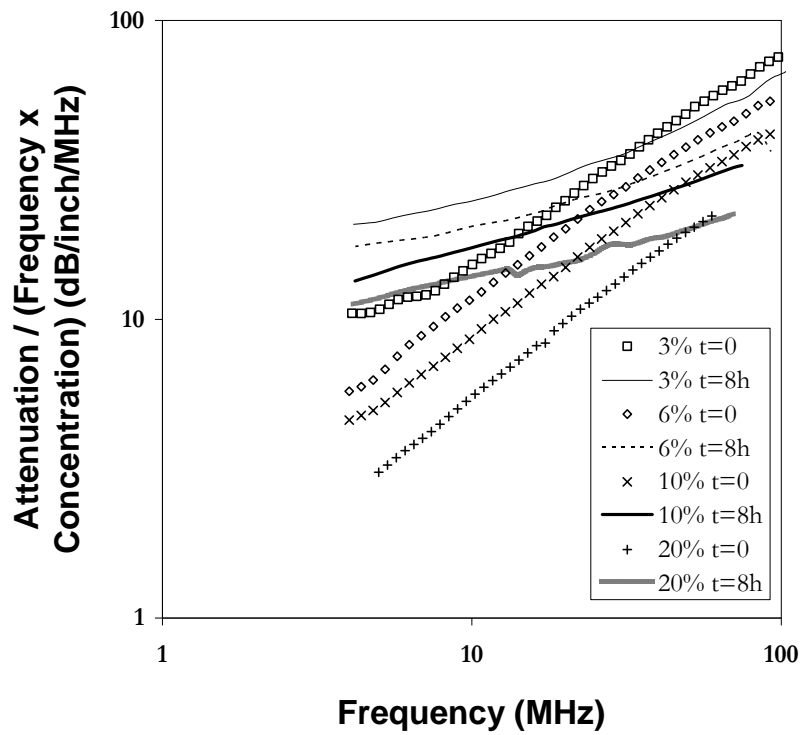

Figure 6: Comparison of the attenuation spectra in the suspensions at the beginning and the end of the aggregation process ($t = 8$ hrs) –Effect of the silica concentration.

Silica concentration variations	3%		6%		10%		20%	
	t=0	t=8h	t=0	t=8h	t=0	t=8h	t=0	t=8h
Attenuation spectrum gradient	0.69	0.46	0.51	0.29	0.40	0.27	0.36	0.16
Temperature variations	12°C		25°C		65°C			
	t=0	t=8h	t=0	t=0	t=8h	t=0		
Attenuation spectrum gradient	0.36	0.43	0.37	0.17	0.40	0.19		
Stirring speed variations	1120 tr.min ⁻¹		690 tr.min ⁻¹		450 tr.min ⁻¹		250 tr.min ⁻¹	
	t=0	t=8h	t=0	t=8h	t=0	t=8h	t=0	t=8h
Attenuation spectrum gradient	0.36	0.38	0.37	0.26	0.37	0.17	0.37	0.22

Table 2: Attenuation spectra gradients obtained when the different operating parameters are varied.

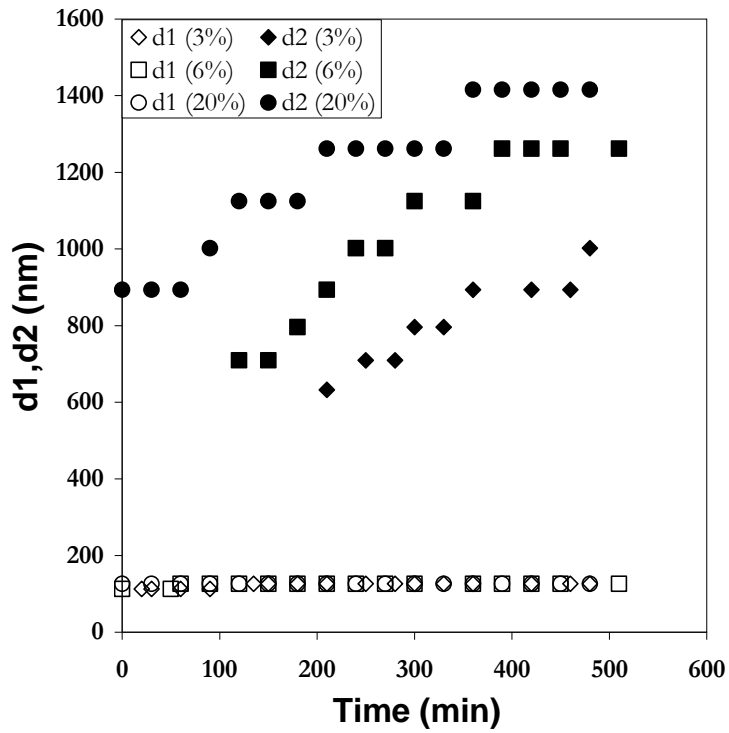

Figure 7: Comparison of the evolution of the modes (d1=peak of primary particles and d2=peak of aggregates) of the particle size distribution for the experiments n°1, 2 and 4.

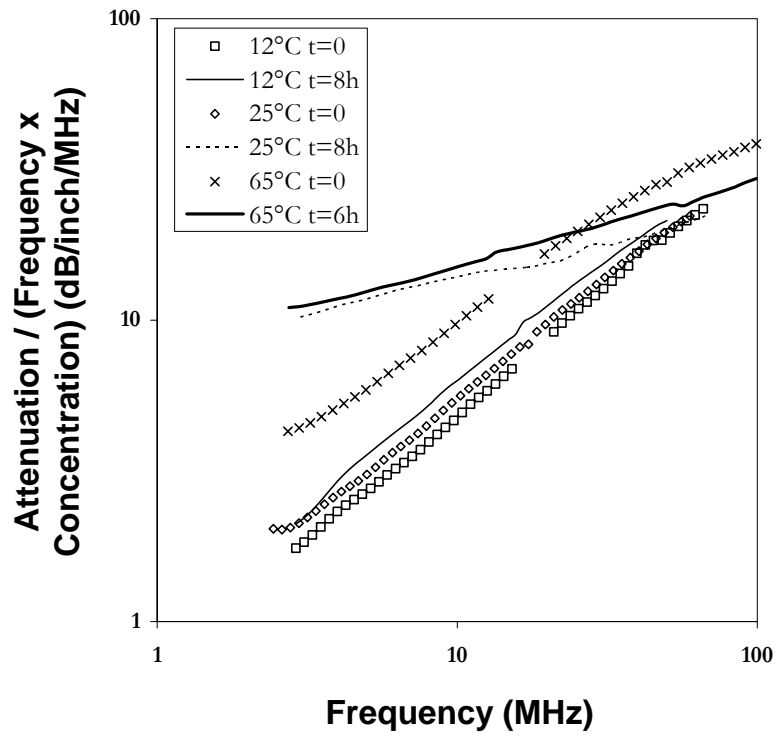

Figure 8: Comparison of the attenuation spectra in the suspensions at the beginning and the end of the aggregation process ($t = 8$ hrs) – Effect of temperature.

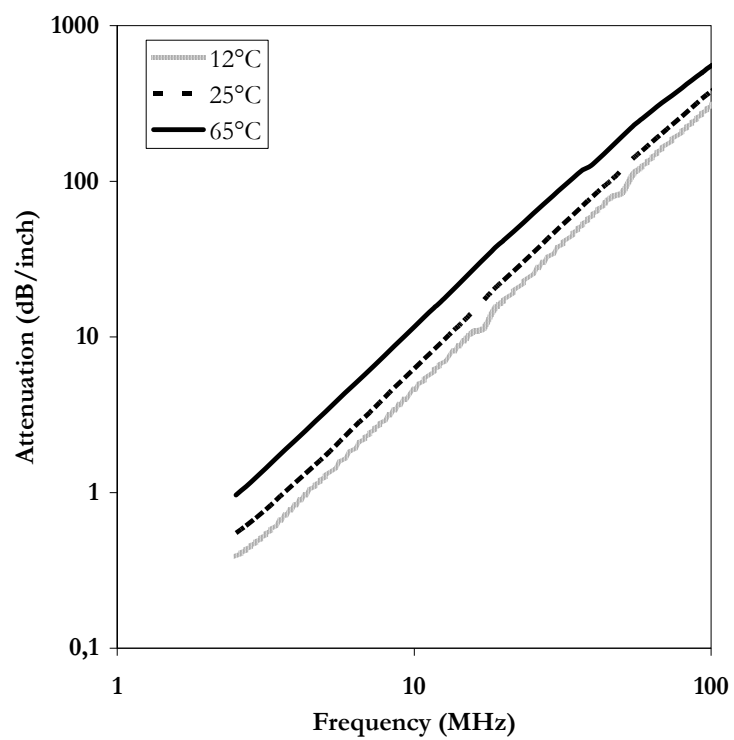

Figure 9: Attenuation spectra in a 30% w/w Klebosol 30R50 suspension at different temperatures: 12°C, 25°C and 65°C.

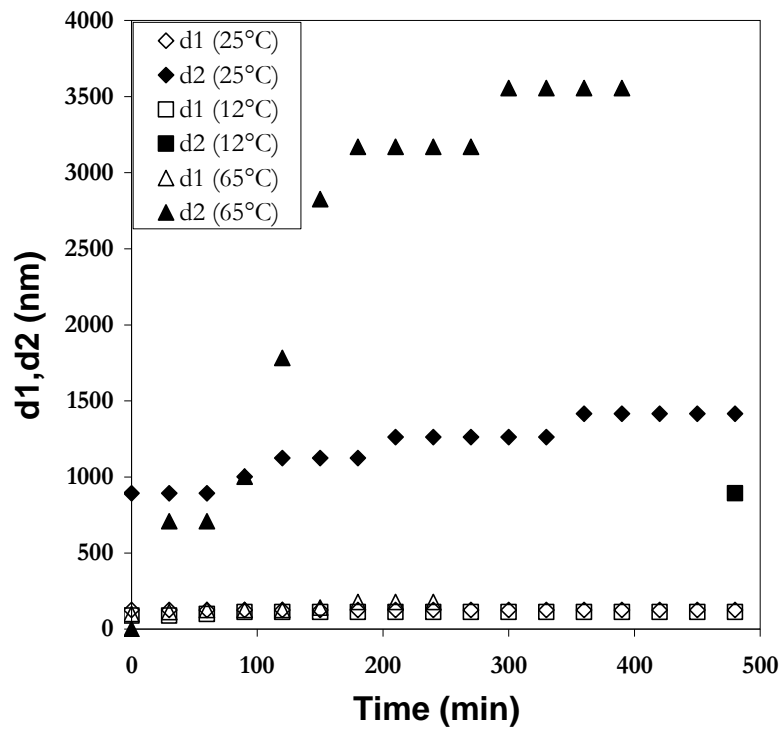

Figure 10: Comparison of the evolution of the modes of the particle size distribution for the experiments n°4, 5, and 6.

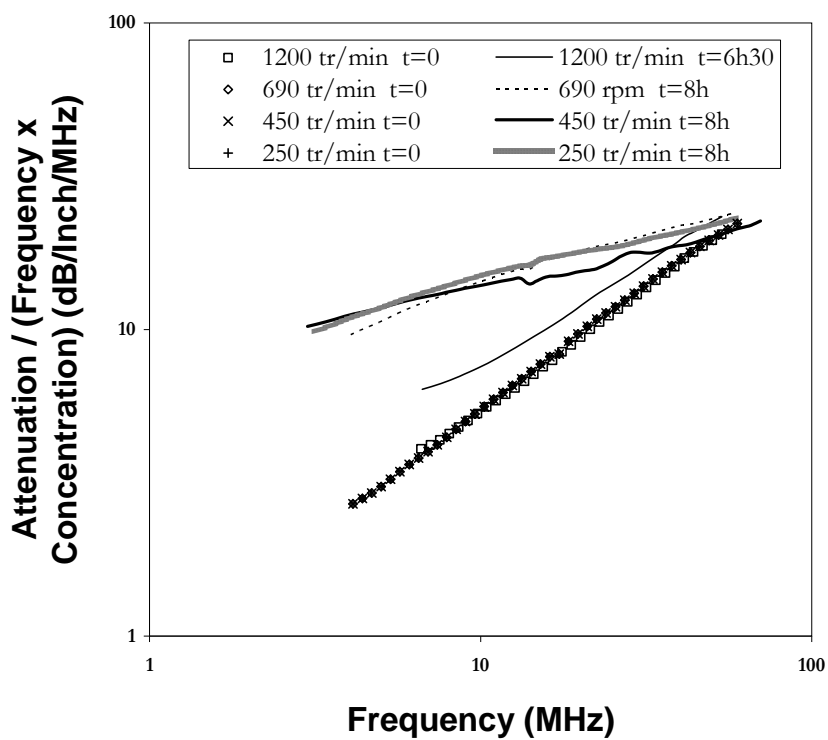

Figure 11: Comparison of the attenuation spectra in the suspensions at the beginning and the end of the aggregation process ($t = 8$ hrs) – Effect of stirring speed.