



HAL
open science

Event-based Extraction of Navigation Features from Unsupervised Learning of Optic Flow Patterns

Paul Fricker, Tushar Chauhan, Christophe Hurter, Benoit Cottureau

► **To cite this version:**

Paul Fricker, Tushar Chauhan, Christophe Hurter, Benoit Cottureau. Event-based Extraction of Navigation Features from Unsupervised Learning of Optic Flow Patterns. 17th International Conference on Computer Vision Theory and Applications, Feb 2022, Vienne (Online Streaming), France. pp.702-710, 10.5220/0010836200003124 . hal-03590636

HAL Id: hal-03590636





<https://hal.science/hal-03590636>

Submitted on 28 Feb 2022

HAL is a multi-disciplinary open access archive for the deposit and dissemination of scientific research documents, whether they are published or not. The documents may come from teaching and research institutions in France or abroad, or from public or private research centers.

L'archive ouverte pluridisciplinaire **HAL**, est destinée au dépôt et à la diffusion de documents scientifiques de niveau recherche, publiés ou non, émanant des établissements d'enseignement et de recherche français ou étrangers, des laboratoires publics ou privés.

Event-based Extraction of Navigation Features from Unsupervised Learning of Optic Flow Patterns

Paul Fricker^{1,2}^a, Tushar Chauhan¹^b, Christophe Hurter²^c and Benoit R. Cottureau¹^d

¹*Centre de Recherche Cerveau et Cognition, CNRS UMR5549, Toulouse, France*

²*Ecole Nationale de l'Aviation Civile, Toulouse, France*

Keywords: Optic Flow, Spiking Neural Network, Unsupervised Learning, STDP.

Abstract: We developed a Spiking Neural Network composed of two layers that processes event-based data captured by a dynamic vision sensor during navigation conditions. The training of the network was performed using a biologically plausible and unsupervised learning rule, Spike-Timing-Dependent Plasticity. With such an approach, neurons in the network naturally become selective to different components of optic flow, and a simple classifier is able to predict self-motion properties from the neural population output spiking activity. Our network has a simple architecture and a restricted number of neurons. Therefore, it is easy to implement on a neuromorphic chip and could be used for embedded applications necessitating low energy consumption.

1 INTRODUCTION

During locomotion, retinal optic flow patterns are used by numerous animal species to monitor their heading and moving speed. In primates, optic flow is processed through a hierarchical network that first extracts local motion components, combines them to determine global motion properties, and subsequently estimates navigation parameters. This process is very efficient in terms of energy consumption as information in the primate visual system is transmitted under a binary form (spikes), and it is generally admitted that the brain only requires about 20 watts to function (Mink et al., 1981). Reproducing these neural mechanisms in artificial and embedded systems could have significant implications in industrial (e.g., autonomous vehicles) and clinical (e.g., navigation with computer assistance in blind patients) domains. The last years have seen the emergence of numerous studies where the optic flow was computed from a bio-inspired perspective, thanks to the development of event-based cameras. Similar to the human retina, these cameras, also known as dynamic vision sensors (DVS), emit spikes at locations where a change in log-luminance (an increment or a decrement) is detected

in the visual inputs. Transmission is asynchronous and has a very high temporal resolution (down to the millisecond, (Posch et al., 2014)), which is potentially very advantageous for real-time applications given the subsequent treatment of the spikes is adequately performed.

A natural way to process the spikes emitted by event-based cameras is to use spiking neural networks (SNNs). These networks favor low power computation as they can be directly implemented on neuromorphic chips such as Intel Loihi (Davies et al., 2018) or IBM TrueNorth (Akopyan et al., 2015). Learning with SNNs can be performed with or without supervision. In the first case, the discrete nature of spikes makes it challenging to estimate the network parameters through back-propagation, even though recent developments such as the surrogate gradient method have led to promising results (Nefteci et al., 2019; Zenke et al., 2021). Learning in this case often necessitates a large amount of labeled data, and generalization to other visual contexts is not always guaranteed. Unsupervised approaches can provide an interesting alternative to supervised methods as they are more flexible to modifications in the input and do not need labeled datasets.

In this paper, we describe a simple, functional, and efficient spiking neural network that learns to extract meaningful optic flow components during natural navigation conditions using a bio-inspired and unsupervised rule, the spike-timing-dependent plastic-

^a  <https://orcid.org/0000-0002-0560-7827>

^b  <https://orcid.org/0000-0002-0396-4820>

^c  <https://orcid.org/0000-0003-4318-6717>

^d  <https://orcid.org/0000-0002-2624-7680>

ity or STDP. We demonstrate that after training, the output units of the network become selective to optic flow components, and notably, to translational, rotational, and radial patterns. Moreover, we show that the activation of these units can be used to predict self-motion direction during navigation.

In the next sections, we begin with an overview of the state-of-the-art in the field (section 1.1). This is followed by a description of our methodology (section 2) and then by a presentation of our results (section 3).

1.1 Related Work

Over the last decade, an increasing number of studies have used event-based data for computer vision, with performances sometimes better than those obtained from more classical frame-based cameras in applications like object recognition (Neil and Liu, 2016; Stromatias et al., 2017), or visual odometry (Gallego and Scaramuzza, 2017; Nguyen et al., 2019). These studies were all based on deep convolutional neural networks or SNNs, coupled with supervised learning or classification approaches (see (Lakshmi et al., 2019)). For example, (Zhu et al., 2019) used an artificial neural network (ANN) to predict the optic flow from event-based data collected from a camera mounted on the top of a car moving within an urban environment (see also (Zhu et al., 2018)). In (Lee et al., 2020), the authors used the same dataset but processed it with a hybrid ANN/SNN neural network which produced even better optic flow estimations. Because they were not fully spiking, these approaches are difficult to implement on neuromorphic chips directly. In addition, these supervised approaches also require a large amount of labeled data which are not always available.

Alternative approaches based on unsupervised learning were also developed. In (Bichler et al., 2012), the authors demonstrated that motion selectivity could be learned by SNNs equipped with a bio-inspired STDP learning rule. Their network was able to discriminate motion direction on synthetic event-based data and also to count the vehicles in different highway lanes from data collected with a dynamic vision sensor (DVS). In recent work, (Oudjail. and Martinet., 2019; Oudjail. and Martinet., 2020) showed that only a small number of neurons are required to learn simple motion patterns from the STDP rule. However, in this case, the simulated inputs were restricted to a 5×5 pixels window, as opposed to 16×16 pixels for the simulations and 128×128 for the DVS data in (Bichler et al., 2012).

In (Paredes-Vallés et al., 2020), a deep hierarchi-

cal network including transmission delays and numerous layers was able to estimate the motion patterns of moving objects after unsupervised learning through STDP. This network was nonetheless complex and comprised different data formatting approaches distributed across multiple layers and neurons. Even more recently, (Debat et al., 2021) used the same type of SNN to show that learning through STDP led to neural populations whose spiking activity can be used to predict trajectories.

Here, we build on these studies to develop a novel SNN which, when equipped with STDP, learns to extract optic flow properties, notably self-motion direction during navigation, from event-based data collected under natural locomotion conditions. Our SNN is simpler than those proposed in previous works and thus easier to set up and optimize. Given its straightforward nature and its small number of internal parameters, it can also be implemented easily on neuromorphic chips with low power consumption.

2 METHODS

Our processing pipeline consists of an SNN which processes event-based data consistent with those received by the primate retina during locomotion. In this section, we first describe the different types of event-based data used as inputs to our network (section 2.1). We subsequently describe our neural network's properties (section 2.2) and the unsupervised learning rule used for training (section 2.3). We finally detail the evaluations employed to characterize the networks' properties after learning (section 2.4).

2.1 Event-based Inputs

Two different datasets were used to train our network. They are described in the following two sections.

2.1.1 Simple Simulations of Optic Flow

To characterize the ability of our network to learn optic flow components, we designed simulations in which four bright disks (one in each quadrant of the visual field) were either translating (leftward, rightward, upward, and downward), rotating (clockwise and counter-clockwise), or expanding/contracting in front of a black background (see figure 1-A). The disks had a diameter of 6 pixels, and the total size of the visual field was 32×32 pixels (a quadrant was 16×16 pixels). Each simulation was generated from 16 temporal frames presented at different speeds: 120,

240, or 480 pixels per second, leading to video sequences of 133 ms, 67 ms, or 33 ms, respectively. We used 800 simulations in total for the training of our SNN (100 for each optic flow pattern, presented in random order). These sequences were filtered by spatial kernels consisting of a difference of Gaussian (DoG) of 5×5 pixels. Spikes were generated each time the difference between the outputs of these filters between two successive frames exceeded a given threshold in absolute value (see figure 1B). For each spike, the information transmitted to the SNN contained its timing, location, and polarity (see section 2.1.3).

These simulations provided an excellent framework to evaluate our approach because they permitted full control of the optic flow patterns transmitted to the SNN (see (Bichler et al., 2012) for another example of synthetic event-based data with 2D motion). They also permitted us to characterize the robustness of the model to noise by manipulation of the signal-to-noise ratio (SNR) in the input spikes. This SNR manipulation was done by adding random spikes in the input.

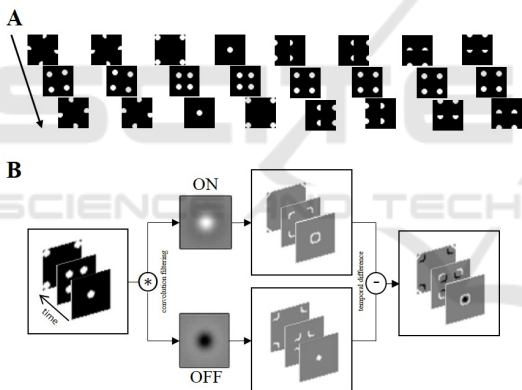

Figure 1: Generation and pre-processing of the optic flow simulations A) From left to right: clockwise and counter-clockwise rotations, contracting and expanding patterns, rightward, leftward, upward and downward translations. B) Spike generation from a spatio-temporal filtering of the different components through DoG filters (ON and OFF) and temporal differences.

2.1.2 Event-based Data Collected during Navigation in the Environment

We used a second dataset composed of visual input spikes captured by an event-based camera mounted on a pedestrian’s head as they walked within an urban environment (Mueggler et al., 2017). The camera was a DAVIS characterized by a spatial resolution of 240×180 pixels with a minimum latency of $3 \mu\text{s}$ and a 130 dB dynamic range (Brandli et al., 2014). To train

and evaluate our SNN, we restricted our analyses to spikes generated from the central part (a square of 60×60 pixels) of the visual field. This restriction permitted us to limit the number of incoming spikes processed by our SNN and improve the processing speed.

An Internal Measurement Unit (IMU) was used during the collection of the data. It provided the ground-truth X, Y, and Z values for the acceleration and angular velocity of the pedestrian trajectories at 1 kHz. The path followed during data acquisition consisted of a large loop across an urban environment. The pedestrian walked forward for 133 seconds, and made lateral (left/right) turns. There were more rightward turns in the path, with only a few turns to the left. As a consequence, the walking sequence mainly featured forward and rightward motions.

2.1.3 Data Format

Whether from simulated data or event-based cameras, spikes were coded using an Address-Event Representation (AER), which contained their spatial coordinates, timestamps, and polarities. They were subsequently grouped into batches of the same duration and transmitted to the SNN through a scheduler, treating all incoming events. After each batch processing, the SNN entered a resting period. During it, the membrane potentials of all the neurons were reset to their baseline level.

2.2 Spiking Neural Network

2.2.1 Architecture

Our SNN was composed of two layers with lateral inhibition. This reduced, 2-layer structure, allowed us to keep the number of parameters low, which could facilitate its implementation on a neuromorphic chip. The first layer was retinotopically organized: each of its neurons received afferent spikes from only one quadrant of the visual field. We used 64 neurons in total in this layer (16 for each quadrant). They received AER data via the scheduler (see section 2.1.3). Neurons in the second layer (64 in total) were fully connected to the outputs of the first layer. Figure 2 provides an overview of our architecture.

2.2.2 Spiking Neuron Model

Our neuron model is based on Leaky-Integrate-and-Fire (LIF) units (Gerstner and Kistler, 2002). A LIF neuron has a membrane potential V_m , a resting potential V_{rest} , a membrane resistance R_m , a time constant τ_m , and an input current I . The membrane potential of a LIF neuron increases every time it receives an input

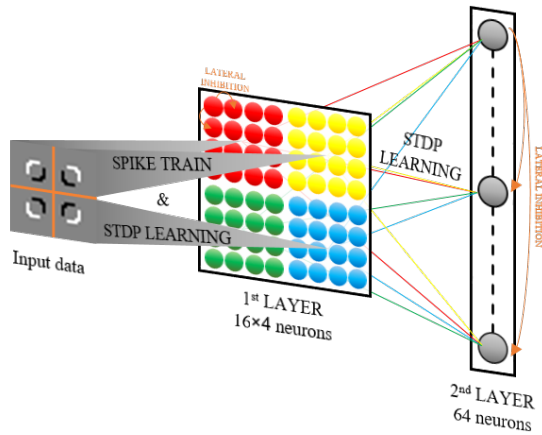

Figure 2: General architecture of our SNN. Neurons in the first layer are retinotopically organized and only received afferent spikes from one quadrant of the visual field (see the different colours). Neurons in the second layers are fully connected to the outputs of the first layer. Unsupervised learning is first performed in the first layer. After convergence of the synaptic weights, spikes are transmitted to the second layer and the STDP rule is applied.

spike. In the absence of inputs, the membrane potential exponentially decays over time. When the membrane potential reaches the threshold potential V_{thresh} , the neuron emits a spike, and its potential remains at a resting state during a refractory period. This behavior is illustrated in figure 3 and can be characterized by the following equation:

$$\tau_m \frac{d}{dt} V_m(t) = -(V_m(t) - V_{rest}) + R_m I(t) \quad (1)$$

During the refractory period following a spike emission, the membrane potentials of the other neurons in the network were not updated.

2.3 Unsupervised Learning with Spike-Timing-Dependent Plasticity

Learning in our SNN is unsupervised and regulated by the STDP rule. Originally described by (Bi and Poo, 1998; Markram et al., 1997), the STDP is believed to reflect a general learning principle in the nervous system of living organisms (Dan and Poo, 2004). It relies on the spike time difference between pre and post-synaptic neurons. When a pre-synaptic neuron emits a spike just before a post-synaptic neuron, its synaptic weight is reinforced through long-term potentiation (LTP). On the other hand, when the post-synaptic neuron fires first, the synaptic weight is decreased through long-term depression (LTD). In our study, we used an additive version of the STDP rule,

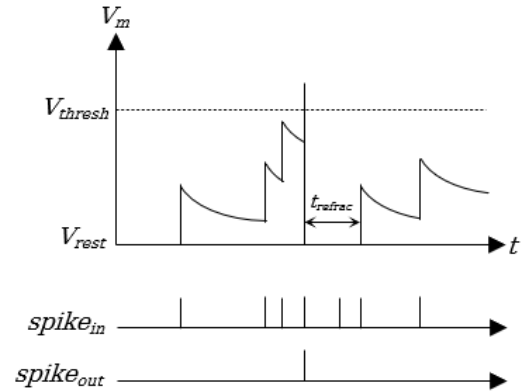

Figure 3: LIF neuron. The membrane potential V_m varies as a function of the incoming spikes $spike_{in}$. When the threshold V_{thresh} is reached, the neuron emits a spike $spike_{out}$ and returns to its resting state. It remains in this resting state for a refractory period t_{refrac} .

which can be described by the equation 2 below and is graphically represented in figure 4.

$$\Delta w = \begin{cases} -A_{LTD} + w \cdot e^{\frac{\Delta t}{\tau}}, & \Delta t \leq 0 \\ A_{LTP} + w \cdot e^{\frac{-\Delta t}{\tau}}, & \text{otherwise.} \end{cases} \quad (2)$$

Here, Δw is the synaptic weight change, A the amplitude of this change, w the current weight, τ the time constant, and Δt the time difference between the input and output spikes. To prevent neurons in our SNN from learning the same patterns, we added a lateral inhibition mechanism in each of our two layers (see (Chauhan et al., 2018)). Whenever a neuron emits a spike, it prevents all the other neurons from the same layer from firing until the next input batch is processed.

2.4 Evaluation

To characterize the ability of our network to process optic flow, we used different evaluation metrics. We first characterized the selectivity of the SNN after learning. Because optic flow patterns are widespread in our inputs, we expected neurons in the second layer to progressively become responsive to the different patterns. This expectation was measured by characterizing their receptive fields and responses after training.

To complete these observations, we also computed confusion matrices using the approach proposed by (Diehl and Cook, 2015). After learning, we characterized the responses of each neuron in the second layer to the different optic flow patterns by presenting it the training set used for learning, with the learning rate set to zero. For a given neuron, the preferred optic

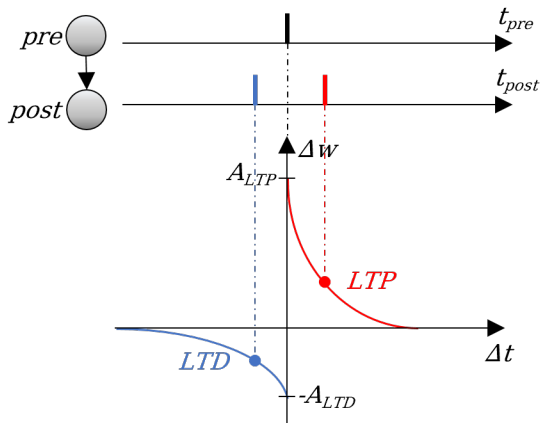

Figure 4: Illustration of the STDP learning rule. When a pre-synaptic neuron spikes just before the post-synaptic neuron, their associated synaptic weight is increased by Δw via long-term potentiation (LTP). The increase is more important for short spike time differences $\Delta t = t_{post} - t_{pre}$ (see the red curve). At the opposite, the synaptic weight is decreased via long-term depression (LTD) when the pre-synaptic neurons emits a spike after the post-synaptic neuron (see the blue curve).

flow component corresponds to the one which leads to the maximum number of output spikes across all the trials. Once this labeling was done, predicting the label of any new trial was determined by selecting the most frequent label in the population response. The confusion matrix specifies the distribution of the labels associated with our simulation's different optic flow components. In an ideal SNN, the confusion matrix is the identity matrix.

3 RESULTS

We present here the results obtained by training our SNN with the two event-based datasets (see sections 2.1.1 and 2.1.2).

3.1 Learning from Optic Flow Simulations

After learning on the synthetic event-based optic flow dataset, 50 percent of the neurons in the second layer of our SNN developed a selectivity to optic flow. Figure 5 illustrates the responses of eight of these neurons before (5-A) and after (5-B) unsupervised training through STDP. While the receptive fields (on the left) are initially random, we can observe that they became highly structured and responsive to different optic flow patterns after learning. For example, the neuron illustrated in the first row is selective to up-

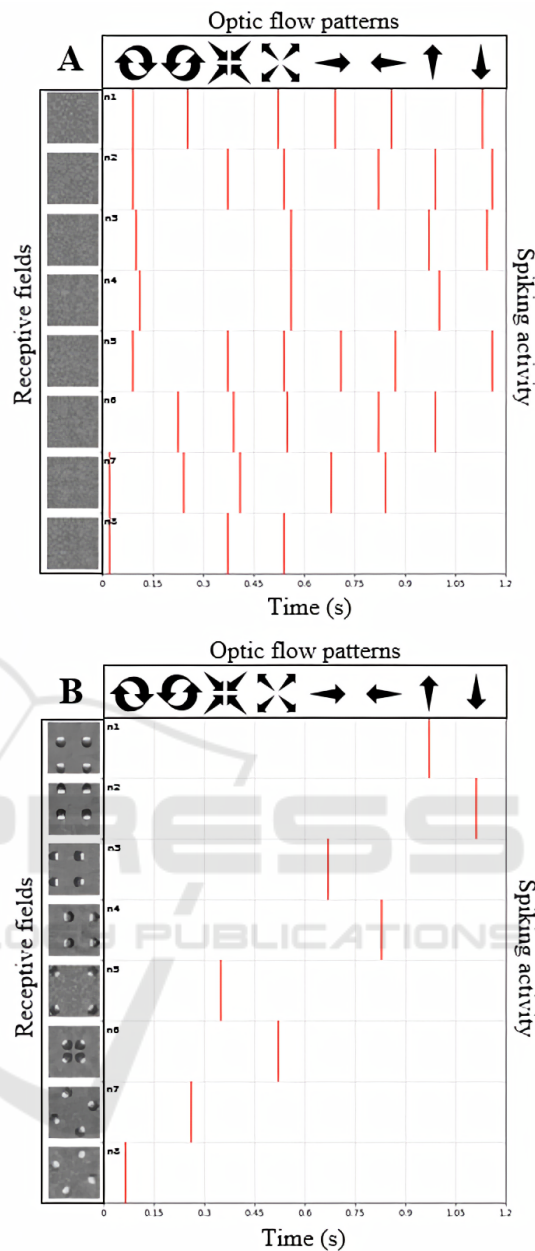

Figure 5: Illustration of the spiking activity of our SNN before (A) and after (B) unsupervised training using synthetic event-based data with different optic flow patterns. We show the receptive fields of the neurons on the leftward columns. White and dark regions respectively correspond to luminance onsets and offsets. Responses to different optic flow patterns (the different conditions are provided on the upward row) are shown on the rightward columns.

ward translation. The rightward columns present the spiking activity of these neurons in responses to different optic flow patterns (optic flow conditions are shown on the top). Before learning, each neuron responds to different optic flow conditions. In contrast,

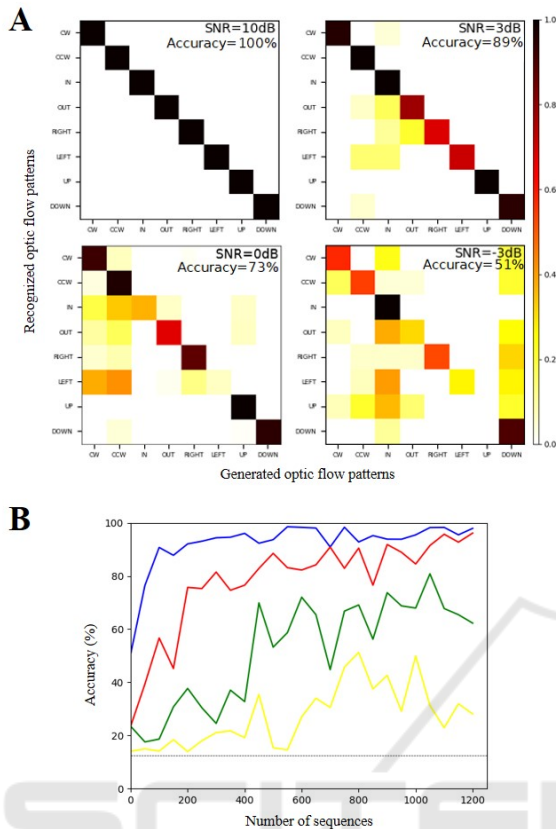

Figure 6: Performances of our SNN on the synthetic event-based dataset. A) Confusion matrices obtained when labeling eight different optic flow patterns for four different noise levels (SNR = 10, 3, 0 and -3 dB). Global performances are provided on the upper right corners. B) Accuracy level (in percentages) as a function of the number of presented sequences (from 1 to 1200) for different SNR values (10 dB in blue, 3 dB in red, 0 dB in green, and -3 dB in yellow). The dashed line gives the chance level (12.5 percent in this case).

after training, when presented 80 sequences (10 for each optic flow condition in random order), responses are sparse, and each neuron only spikes to one optic flow pattern.

Next, we examined the properties of our SNN at the population level using confusion matrices. Figure 6 provides matrices estimated under multiple noisy conditions (A) and a varying number of sequences presented to the network (B). In the absence of noise, the nature of the optic flow pattern can be fully recovered from the spiking activity of the network. When noise is added, performances decrease but remain largely above chance (12.5 percent) even for high noise levels. For example, there are still 73 percent correct predictions for an SNR of 0 dB. Importantly, to control that learning in our SNN was not

based on the initial positions of the discs, we ran additional simulations where these positions were randomly picked along the trajectories. Classification performances of the network after convergence remained unchanged. Notably, the optic flow component was always fully recovered in the absence of noise. This demonstrates that the network learns the displacement of the discs.

With this simulated dataset, the second layer neurons, which did not converge, kept random receptive fields after learning, even when we increased the number of presented motions in the training set. This is likely to be driven by the fact that our simulations only included eight conditions, and in this case, only a limited number of neurons is needed to extract motion direction from the inputs. In addition, lateral inhibition in our network (see section 2.3) prevented other neurons from learning the same patterns. As we will see below, all the second layer neurons converged when the training was performed using real (and therefore more complex) data.

3.2 Learning from Navigation DVS Data

We now examine the performances of our SNN on real event-based data collected during locomotion. Using the ground-truth angular velocities provided by the IMU (see section 2.1.2), we segmented this dataset into three distinct categories: leftward, onward, and rightward self-motions. After training, all neurons in the second layer of the SNN developed specific responses to optic flow. In figure 7, we show the spiking activity from eight of these neurons before (7-A) and after (7-B) unsupervised training through STDP. The labels of the optic flow patterns are shown on the top. As with the synthetic event-based data, we can observe that neural activity is initially random (receptive fields are noisy, and neurons respond to all optic flow conditions). After training, it is much more specific as neurons show structured receptive fields and fire only for one optic flow category. For example, the neuron presented on the first row became selective to leftward motion. All the other neurons are only responsive to one condition.

Next, we tested whether the spiking activity of the SNN can predict these labels. This process is the same as described in section 2.4. In this case, the chance level is at 33.33 percent. In figure 7-C, we show the performances of our SNN on this navigation dataset. Training led to an overall accuracy of 87.5 percent of correct classification between the three optic flow patterns. This score is well above chance, even though some of the leftward (and less frequently forward) se-

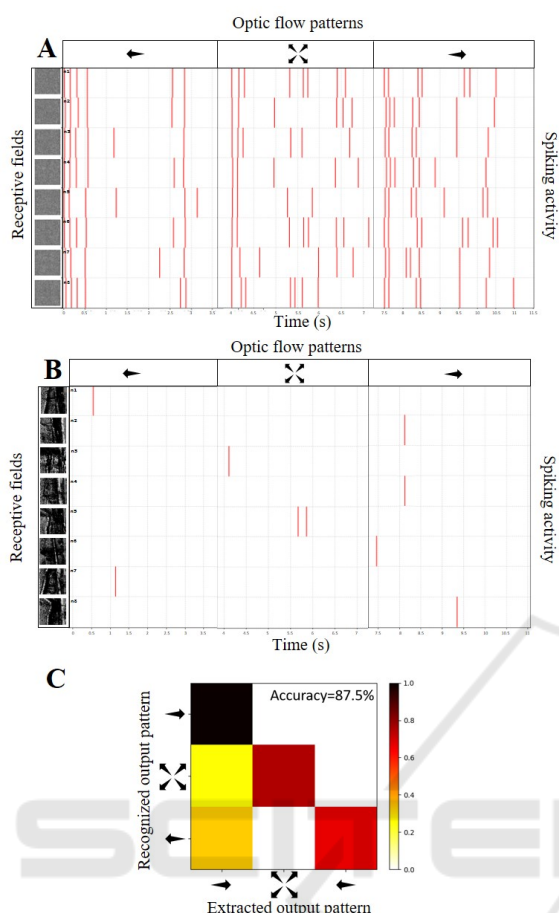

Figure 7: Performances of our SNN on event-based data collected during navigation in the environment. Receptive fields (leftward columns) and spiking activity (rightward columns) are shown before (A) and after (B) training for eight representative neurons in the second layer of our SNN. C) Confusion matrix after training. Our SNN was able to label 87.5 percent of the sequences correctly.

quences were misclassified as rightward motions. As mentioned in section 2.1.2, the navigation data mostly contained rightward and forward motions, which may explain the classifications biases observed here. Future works should examine in more detail whether the same SNN trained with more balanced motion inputs would reach better classification performances.

4 DISCUSSION

In this paper, we present a simple SNN (see figure 2) capable of extracting optic flow components from event-based data. Learning in our network is fully unsupervised and depends on a bio-inspired learning rule, spike-timing-dependent plasticity (see figure 4). After convergence, neurons in the network become

selective to different optic flow components, and their spiking activity at the population level can be used to determine self-motion direction during navigation. These properties are observed with both simulated data (see figure 6) as well as real data collected with a DVS camera during locomotion (see figure 7).

Our SNN comprises 128 neurons in its two layers while (Paredes-Vallés et al., 2020), (Bichler et al., 2012) and (Diehl and Cook, 2015) respectively used 177, 266 and 6400 neurons in their networks (NB: A much smaller number of neurons was used by (Oudjail. and Martinet., 2019; Oudjail. and Martinet., 2020), but in their case, inputs were restricted to translations in four directions in a small grid of 5 x 5 pixels). After learning, our SNN requires 10 spikes on average to correctly classify an optic flow pattern. As a single spike is estimated to consume between 700 and 900 pJ on a neuromorphic chip (Indiveri et al., 2006; Aamir et al., 2018; Asghar et al., 2021), our network would therefore need between 7 and 9 nJ to characterize self-motion. Because of its simple architecture (only two layers and 128 neurons) and low energy consumption when implemented on a chip, our SNN is a good candidate for embedded applications where an accurate estimation of optic flow is necessary, for example, in autonomous vehicles or for navigation with computer assistance in blind patients.

The event-based navigation dataset that we used here was limited, and the walking path of the pedestrian mostly contained forward and rightward displacements. In the near future, the properties of our SNN will be characterized using a more balanced and fuller dataset. Also, the predictions obtained from the output spiking activity of our network were restricted to the pattern of optic flow (i.e., to the direction of self-motion). Future improvements could include an estimation of the exact displacement and velocities of the camera within the 3D environment (see for example (Debat et al., 2021) for an estimation of the 2D trajectories from the outputs of an SNN trained with STDP). This could be realized by adding other layers to the SNN or including a second event-based camera to support stereoscopic vision.

ACKNOWLEDGMENTS

Paul Fricker was funded by a PhD fellowship from the Occitanie region awarded to Benoit R. Cottreau and Christophe Hurter. This research was also supported by a grant from the ‘Agence Nationale de la Recherche’ (ANR-16-CE37-0002-01, ANR JCJC 3D3M) awarded to Benoit R. Cottreau.

REFERENCES

- Aamir, S. A., Stradmann, Y., Müller, P., Pehle, C., Hartel, A., Grübl, A., Schemmel, J., and Meier, K. (2018). An accelerated lif neuronal network array for a large-scale mixed-signal neuromorphic architecture. *IEEE Transactions on Circuits and Systems I: Regular Papers*, 65(12):4299–4312.
- Akopyan, F., Sawada, J., Cassidy, A., Alvarez-Icaza, R., Arthur, J., Merolla, P., Imam, N., Nakamura, Y., Datta, P., Nam, G.-J., Taba, B., Beakes, M., Brezzo, B., Kuang, J. B., Manohar, R., Risk, W. P., Jackson, B., and Modha, D. S. (2015). TrueNorth: Design and Tool Flow of a 65 mW 1 Million Neuron Programmable Neurosynaptic Chip. *IEEE Transactions on Computer-Aided Design of Integrated Circuits and Systems*, 34(10):1537–1557. Conference Name: IEEE Transactions on Computer-Aided Design of Integrated Circuits and Systems.
- Asghar, M. S., Arslan, S., and Kim, H. (2021). A low-power spiking neural network chip based on a compact lif neuron and binary exponential charge injector synapse circuits. *Sensors*, 21(13):4462.
- Bi, G.-q. and Poo, M.-m. (1998). Synaptic Modifications in Cultured Hippocampal Neurons: Dependence on Spike Timing, Synaptic Strength, and Postsynaptic Cell Type. *Journal of Neuroscience*, 18(24):10464–10472. Publisher: Society for Neuroscience Section: ARTICLE.
- Bichler, O., Querlioz, D., Thorpe, S. J., Bourgoin, J.-P., and Gamrat, C. (2012). Extraction of temporally correlated features from dynamic vision sensors with spike-timing-dependent plasticity. *Neural Networks*, 32:339–348.
- Brandli, C., Berner, R., Yang, M., Liu, S.-C., and Delbruck, T. (2014). A 240×180 130 db 3 μ s latency global shutter spatiotemporal vision sensor. *IEEE Journal of Solid-State Circuits*, 49(10):2333–2341.
- Chauhan, T., Masquelier, T., Montlibert, A., and Cottureau, B. R. (2018). Emergence of Binocular Disparity Selectivity through Hebbian Learning. *Journal of Neuroscience*, 38(44):9563–9578. Publisher: Society for Neuroscience Section: Research Articles.
- Dan, Y. and Poo, M.-m. (2004). Spike Timing-Dependent Plasticity of Neural Circuits. *Neuron*, 44(1):23–30.
- Davies, M., Srinivasa, N., Lin, T.-H., Chinya, G., Cao, Y., Choday, S. H., Dimou, G., Joshi, P., Imam, N., Jain, S., Liao, Y., Lin, C.-K., Lines, A., Liu, R., Mathaikutty, D., McCoy, S., Paul, A., Tse, J., Venkataraman, G., Weng, Y.-H., Wild, A., Yang, Y., and Wang, H. (2018). Loihi: A Neuromorphic Many-core Processor with On-Chip Learning. *IEEE Micro*, 38(1):82–99. Conference Name: IEEE Micro.
- Debat, G., Chauhan, T., Cottureau, B. R., Masquelier, T., Paindavoine, M., and Baures, R. (2021). Event-based trajectory prediction using spiking neural networks. *Frontiers in Computational Neuroscience*, 15:47.
- Diehl, P. U. and Cook, M. (2015). Unsupervised learning of digit recognition using spike-timing-dependent plasticity. *Front. Comput. Neurosci.*
- Gallego, G. and Scaramuzza, D. (2017). Accurate angular velocity estimation with an event camera. *IEEE Robotics and Automation Letters*, 2(2):632–639.
- Gerstner, W. and Kistler, W. M. (2002). *Spiking Neuron Models: Single Neurons, Populations, Plasticity*. Cambridge University Press, Cambridge.
- Indiveri, G., Chicca, E., and Douglas, R. (2006). A vlsi array of low-power spiking neurons and bistable synapses with spike-timing dependent plasticity. *IEEE Transactions on Neural Networks*, 17(1):211–221.
- Lakshmi, A., Chakraborty, A., and Thakur, C. S. (2019). Neuromorphic vision: From sensors to event-based algorithms. *WIREs Data Mining and Knowledge Discovery*, 9(4):e1310.
- Lee, C., Kosta, A. K., Zhu, A. Z., Chaney, K., Daniilidis, K., and Roy, K. (2020). Spike-flownet: event-based optical flow estimation with energy-efficient hybrid neural networks. In *European Conference on Computer Vision*, pages 366–382. Springer.
- Markram, H., Lübke, J., Frotscher, M., and Sakmann, B. (1997). Regulation of synaptic efficacy by coincidence of postsynaptic APs and EPSPs. *Science (New York, N.Y.)*, 275(5297):213–215.
- Mink, J. W., Blumenschine, R. J., and Adams, D. B. (1981). Ratio of central nervous system to body metabolism in vertebrates: its constancy and functional basis. *The American Journal of Physiology*, 241(3):R203–212.
- Mueggler, E., Rebecq, H., Gallego, G., Delbruck, T., and Scaramuzza, D. (2017). The event-camera dataset and simulator: Event-based data for pose estimation, visual odometry, and SLAM. *The International Journal of Robotics Research*, 36(2):142–149. Publisher: SAGE Publications Ltd STM.
- Neftci, E. O., Mostafa, H., and Zenke, F. (2019). Surrogate Gradient Learning in Spiking Neural Networks: Bringing the Power of Gradient-Based Optimization to Spiking Neural Networks. *IEEE Signal Processing Magazine*, 36(6):51–63. Conference Name: IEEE Signal Processing Magazine.
- Neil, D. and Liu, S.-C. (2016). Effective sensor fusion with event-based sensors and deep network architectures. In *2016 IEEE International Symposium on Circuits and Systems (ISCAS)*, pages 2282–2285. ISSN: 2379-447X.
- Nguyen, A., Do, T.-T., Caldwell, D. G., and Tsagarakis, N. G. (2019). Real-time 6dof pose relocation for event cameras with stacked spatial lstm networks. In *Proceedings of the IEEE/CVF Conference on Computer Vision and Pattern Recognition (CVPR) Workshops*.
- Oudjail, V. and Martinet, J. (2019). Bio-inspired event-based motion analysis with spiking neural networks. In *Proceedings of the 14th International Joint Conference on Computer Vision, Imaging and Computer Graphics Theory and Applications - Volume 4: VIS-APP*, pages 389–394. INSTICC, SciTePress.
- Oudjail, V. and Martinet, J. (2020). Meta-parameters exploration for unsupervised event-based motion analysis. In *Proceedings of the 15th International Joint*

- Conference on Computer Vision, Imaging and Computer Graphics Theory and Applications - Volume 4: VISAPP*, pages 853–860. INSTICC, SciTePress.
- Paredes-Vallés, F., Scheper, K. Y. W., and de Croon, G. C. H. E. (2020). Unsupervised Learning of a Hierarchical Spiking Neural Network for Optical Flow Estimation: From Events to Global Motion Perception. *IEEE Transactions on Pattern Analysis and Machine Intelligence*, 42(8):2051–2064. Conference Name: IEEE Transactions on Pattern Analysis and Machine Intelligence.
- Posch, C., Serrano-Gotarredona, T., Linares-Barranco, B., and Delbruck, T. (2014). Retinomorph Event-Based Vision Sensors: Bioinspired Cameras With Spiking Output. *Proceedings of the IEEE*, 102(10):1470–1484. Conference Name: Proceedings of the IEEE.
- Stromatias, E., Soto, M., Serrano-Gotarredona, T., and Linares-Barranco, B. (2017). An event-driven classifier for spiking neural networks fed with synthetic or dynamic vision sensor data. *Frontiers in neuroscience*, 11:350.
- Zenke, F., Bohté, S. M., Clopath, C., Comşa, I. M., Göltz, J., Maass, W., Masquelier, T., Naud, R., Neftci, E. O., Petrovici, M. A., Scherr, F., and Goodman, D. F. M. (2021). Visualizing a joint future of neuroscience and neuromorphic engineering. *Neuron*, 109(4):571–575.
- Zhu, A. Z., Yuan, L., Chaney, K., and Daniilidis, K. (2018). Ev-flownet: Self-supervised optical flow estimation for event-based cameras. *arXiv preprint arXiv:1802.06898*.
- Zhu, A. Z., Yuan, L., Chaney, K., and Daniilidis, K. (2019). Unsupervised event-based learning of optical flow, depth, and egomotion. In *Proceedings of the IEEE/CVF Conference on Computer Vision and Pattern Recognition*, pages 989–997.
- 