



HAL
open science

Active Control of Violin Bridges

Charles Besnainou, Henri Boutin

► **To cite this version:**

Charles Besnainou, Henri Boutin. Active Control of Violin Bridges. *J. Violin Soc. Am*, 2012, 23 (3). hal-03583425

HAL Id: hal-03583425

<https://hal.science/hal-03583425v1>

Submitted on 21 Feb 2022

HAL is a multi-disciplinary open access archive for the deposit and dissemination of scientific research documents, whether they are published or not. The documents may come from teaching and research institutions in France or abroad, or from public or private research centers.

L'archive ouverte pluridisciplinaire **HAL**, est destinée au dépôt et à la diffusion de documents scientifiques de niveau recherche, publiés ou non, émanant des établissements d'enseignement et de recherche français ou étrangers, des laboratoires publics ou privés.

See discussions, stats, and author profiles for this publication at: <https://www.researchgate.net/publication/325818968>

Active Control of Violin Bridges

Article · January 2012

CITATIONS

0

READS

355

2 authors:



Charles Besnainou
Sorbonne Université

32 PUBLICATIONS 218 CITATIONS

SEE PROFILE



Henri Boutin
Sorbonne Université

35 PUBLICATIONS 139 CITATIONS

SEE PROFILE

Some of the authors of this publication are also working on these related projects:



Active Control of Musical Instruments [View project](#)



Up dated composite musical strings instruments/Enhanced sound radioactivity by 6 dB [View project](#)

Innovation in Violin Making

Active Control of Violin Bridges

CHARLES BESNAINOU¹ AND HENRI BOUTIN²

¹Laboratoire d'Acoustiques Musicales, Université Pierre et Marie Curie
11 rue de Lourmel, 75015 Paris, France
charles.besnainou@upmc.fr

²School of Physics, University of New South Wales
Sydney 2052, Australia
henri.boutin@unsw.edu.au

Thursday, November 6, 2008, 3 pm

Fan Tao, Moderator: I had the privilege of visiting Charles Besnainou's acoustics lab in Paris three years ago. He and other members of the lab are doing some fascinating research in acoustics. Today we will hear about a project Charles has been working on with one of his graduate students.

A little background. Charles is actually a lute player and a lutemaker. He's made hundreds of lutes, many of them using carbon fiber and other composite materials. Also, he has collaborated with Joseph Curtin on many projects. We're so glad to have him come all the way from Paris to show us his latest project.

Charles Besnainou: The purpose of this talk is to show how you can enhance instruments by active control. In the second part of this talk, we are going

to show you our updated research on the bridge activated on a violin.

So what is active control? [Feedback noise from electric guitar] When your electric guitar is in front of a loudspeaker, you have feedback between the sensor of your guitar and the loudspeaker. The musician is able to use his position to make something that could be interesting aesthetically. The purpose of our research is to precisely control feedback as an element of sound quality.

Here's the main principle used in our research: We have a vibrating structure, and on that vibrating structure we have sensors that catch some information such as speed, acceleration, and placement. And then using signal processing, we re-inject forces by means of an activator inside the instrument so that its behavior is changed (Fig. 1).

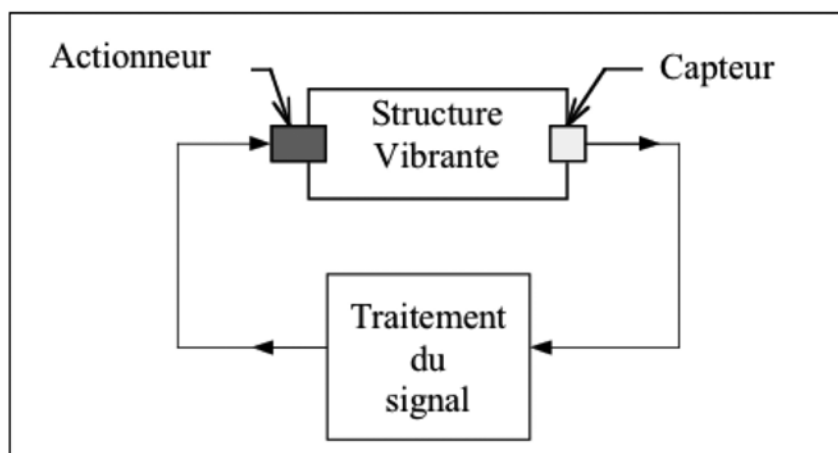

Figure 1. Diagram of the process of modifying the modal vibration behavior of an instrument: 1) Capture the movement of the instrument electronically; 2) process the electronic signal; and 3) inject a force on the instrument to modify its vibration.

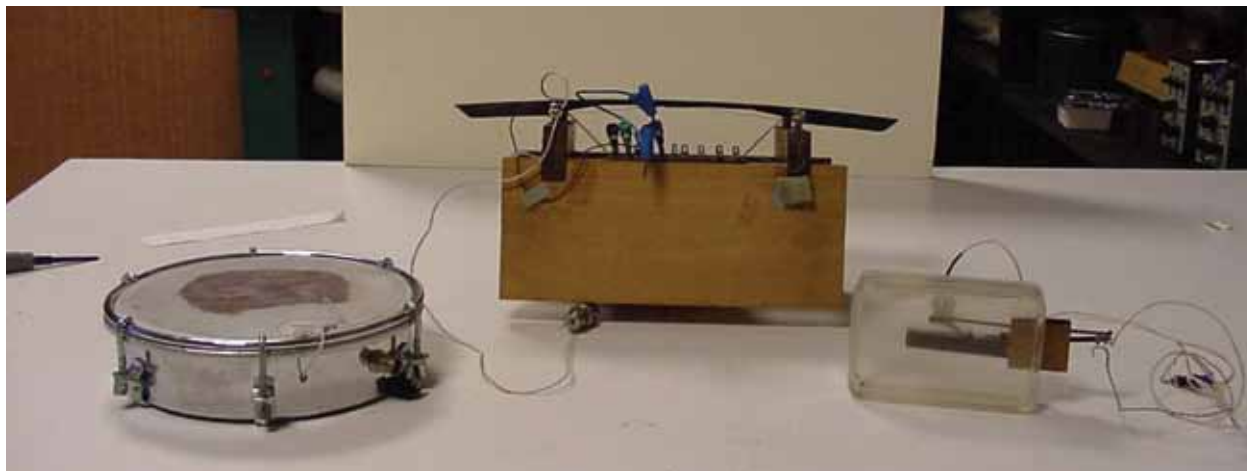

Figure 2. Examples of a drum, a xylophone bar, and a reed under electronic control.

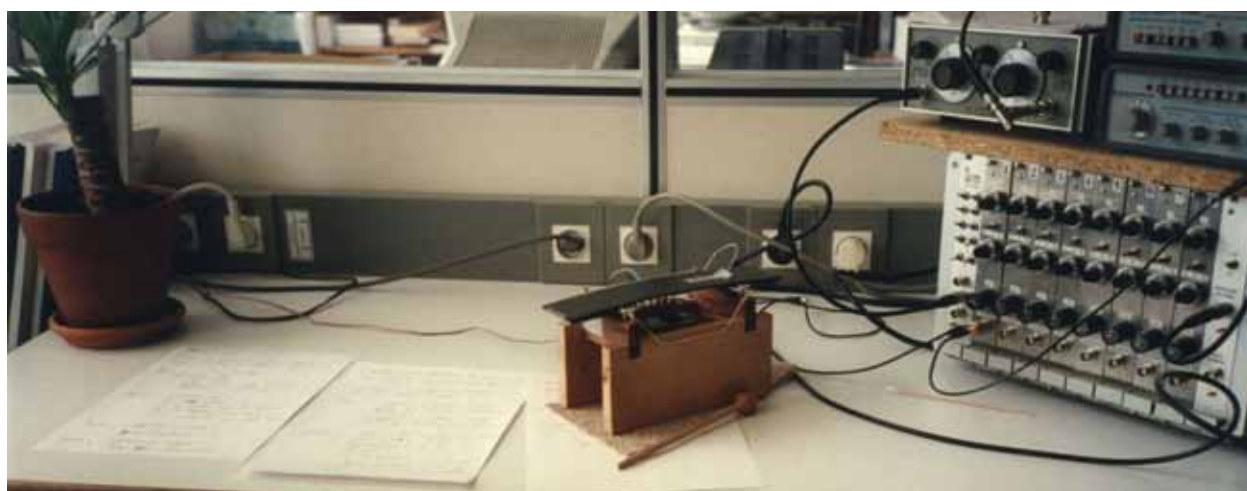

Figure 3. The simplest system: a xylophone bar

It is a way to change the voice of an instrument.

Very simply, as we say a swing is a vibrating mode, we can say that musical instruments can be summarized as many combinations of swings coupled together. As with children playing on their swings in your backyard, they want to be impulsed so that the damping of the system is reduced. If you take time to play with your children, you discover that if you give the impulse at the maximum displacement, you reduce the damping. But if you give the impulse when the swing is at minimum displacement, you can change the period of the swing, and then you change the frequency. This is the principle we use to change the modal behaviors of mechanical systems, including a xylophone bar, a small drum, and a reed (Fig. 2).

A xylophone bar is one of the simplest systems because its modes are quite separate and

identified as mass, damper, and stiffness, i.e., a spring (Fig. 3). Let me give you some results of research we obtained from such an experiment. First, we reduce the damping of the first mode of the xylophone bar. We knock on it [demonstrating sound] to produce a sound, which is detected by a microphone at the rear of the bar (Fig. 4). It is possible to have a different way of controlling the modes of that structure. For instance, we can control two modes at the same time: the first mode [demonstrating sound], and then two modes at the same time [demonstrating sound] (Fig. 5). Now we can change the resonance frequency of the system [demonstrating sounds] (Fig. 6). By means of the loop we have changed the mechanical properties of the mode.

We have made a new instrument that includes an electronic controller device. We can play many

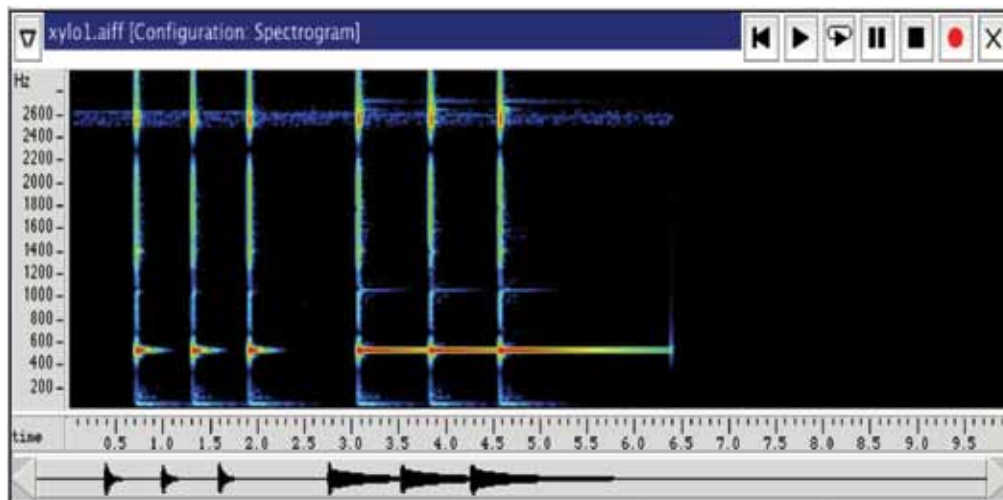

Figure 4. Xylophone exaltation mode 1 (frequency versus time).

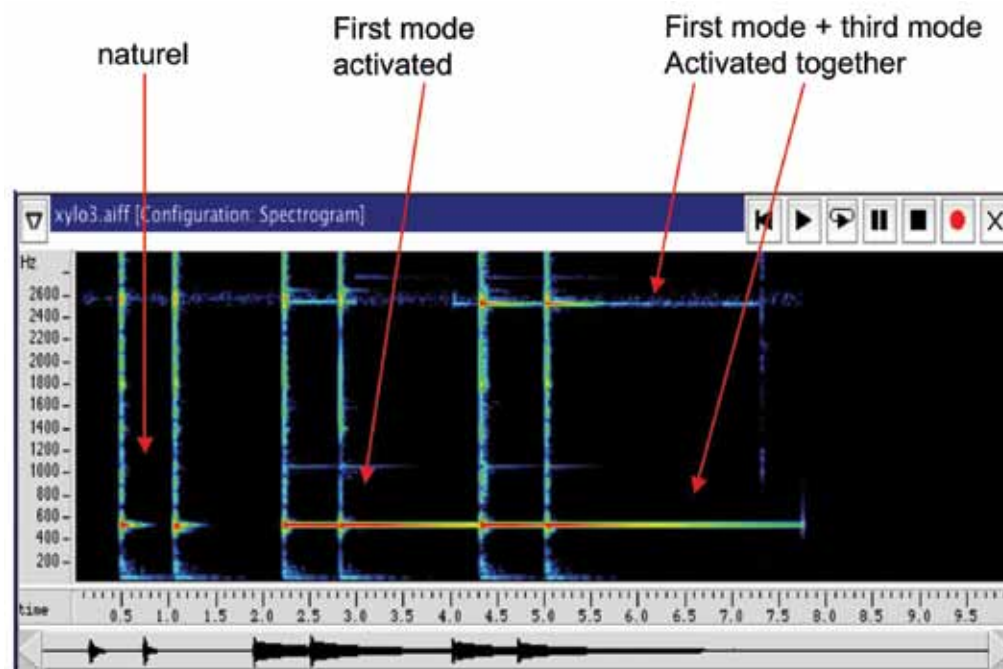

Figure 5. Reducing the damping: time decay lengthened.

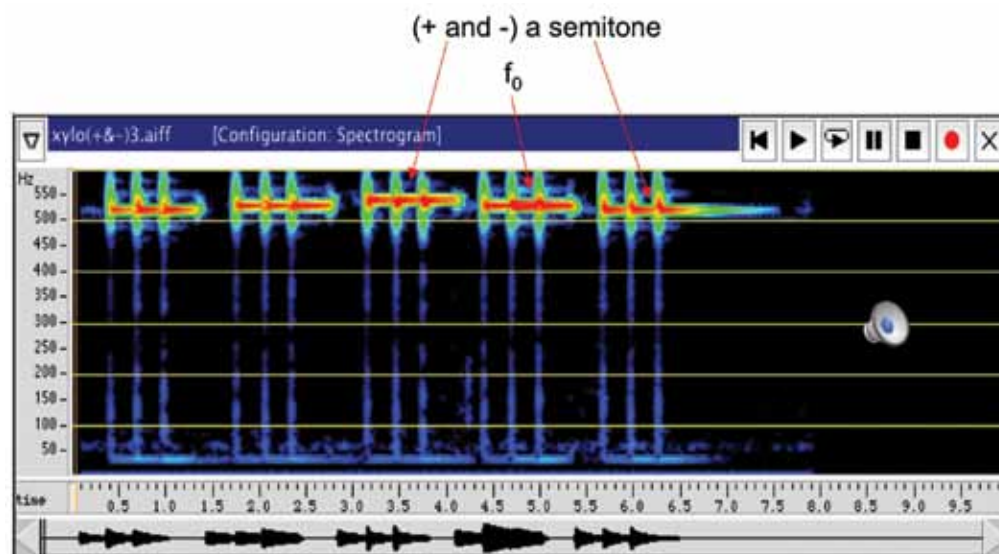

Figure 6. Shifting the resonance frequency of the xylophone bar.

things, such as a xylophone vibrator [demonstrating sound] (Fig. 7). And so on. Here I am able to move the frequencies of the different modes and make them inharmonic, so the sound is like a bell, a small *clochette* [demonstrating sounds] (Fig. 8). If I introduce a nonlinear device into the loop, I can excite many modes of the structure, and the sound could be completely different than the xylophone bar [demonstrating sounds] (Fig. 9).

Now we can do that on a drum, and with this device we can change the pitch of the drum [demonstrating sounds] (Fig. 10). And we can do the same thing on a small reed blown with wind. We have glued on the reed an actuator and a sensor, and you can hear the modulation of the frequencies [demonstrating sound] (Fig. 11).

We have developed an experiment on a violin. The first experiment we did was to introduce a piezoelectric actuator on the soundpost (Fig. 12). We made a loop between a sensor on the bridge and a specially designed controller to re-inject a force on the soundpost to change the frequency response of the whole system. As you see in Fig. 13, it is possible to take the natural mode, de-enhance the mode, or completely eliminate it.

Listen to this [playing violin] (Fig. 14). It is a huge change of voice. Here it's more subtle. The idea is to introduce in the loop a nonlinear device, which applies a nonlinearity to the entire range of frequencies. The effect is a big enrichment of the sound, although it might not be a beautiful sound (Fig. 15).

Please [playing violin]. Activated [playing violin]. The system has the potential to change

the response of an instrument. We might try in a few months to make on a single instrument a very excellent response like a Stradivari violin has.

Now my colleague Henri Boutin is going to talk about bridge adjustment.

Henri Boutin: I am going to present my work with Charles on how to change the vibration of a bridge using an active control technique. In the audible frequency range, the vibration of a violin bridge is mostly composed of two vibration modes: the rocking mode at ~ 3 kHz, and the bouncing mode at ~ 6 kHz (Fig. 16). We have been trying to change the characteristics of the rocking mode using a technique of active control. By measuring the frequency response of the violin, we can see that there is a broad peak in frequency at ~ 3 kHz (boxed area in Fig. 17). This broad peak has been called in many papers the Bridge Hill. This Bridge Hill may determine the identity of the sound of the violin. We wanted to change the characteristics of this Bridge Hill by an active control technique. So the purpose of the study was to change the shape of the Bridge Hill and, secondly, to assess the impact of the modification on the violin's timbre.

First we suggested a very simple physical model of the violin with a bridge, composed of one mass and two springs, connected to a multimodal structure describing the violin body (Fig. 18). Such a model allows the mass to be driven by a rocking mode of vibration. We calculated and plotted its input admittance as a function of frequency (Fig. 18). This curve is composed of many narrow peaks related to the body resonances, which are super-

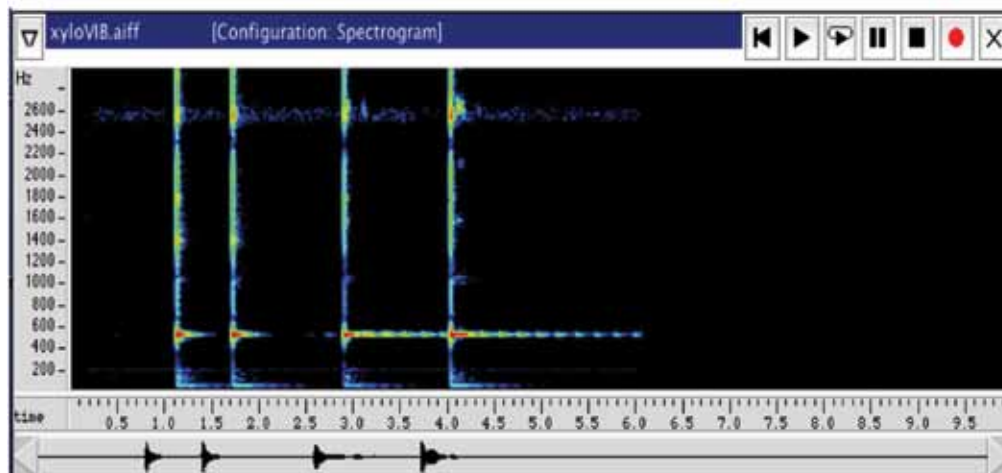

Figure 7. Spectrogram of xylo vibrato.

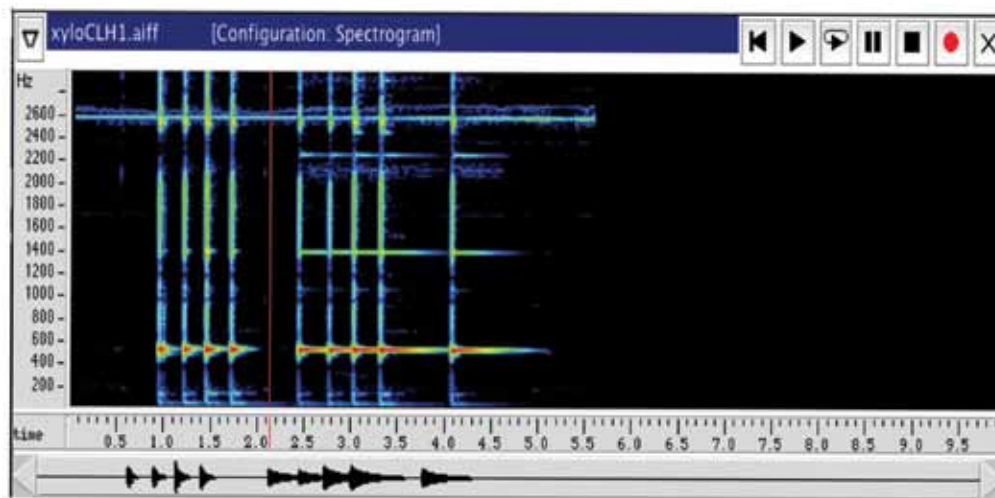

Figure 8. Spectrogram of xylo clochette.

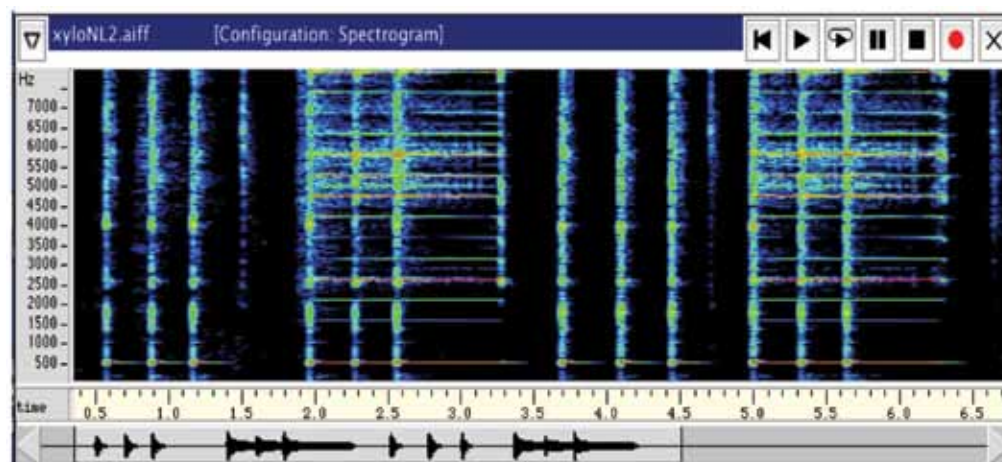

Figure 9. Spectrogram of xylo nonlinear retroaction.

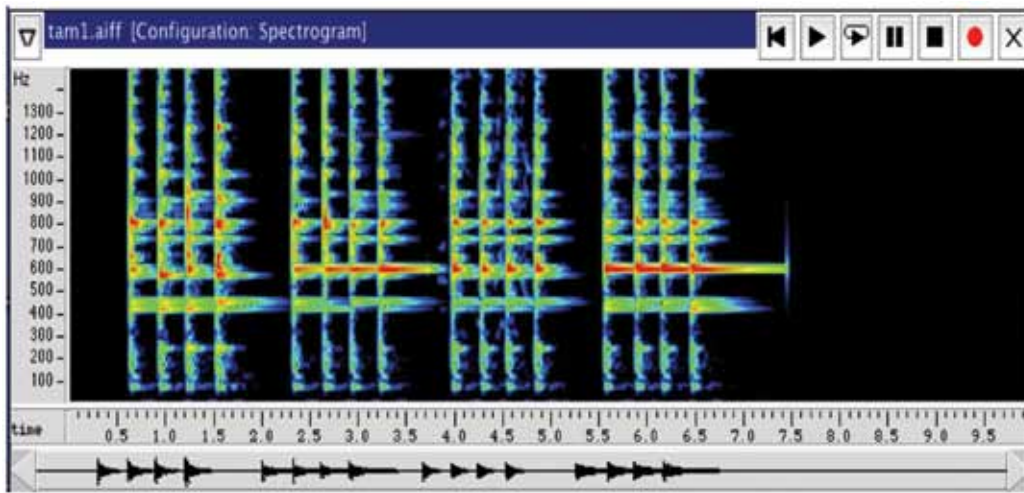

Figure 10. Spectrogram of changing the modes of a drum.

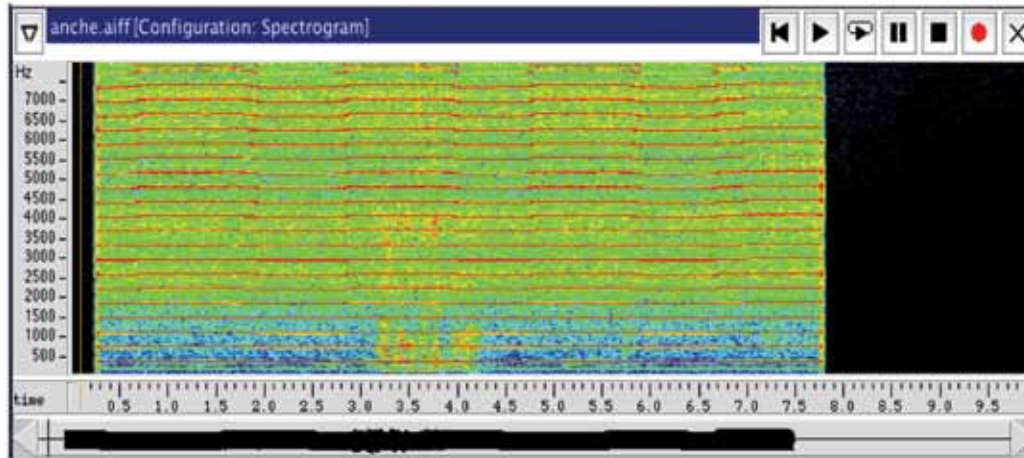

Figure 11. Modulating the frequency of a reed.

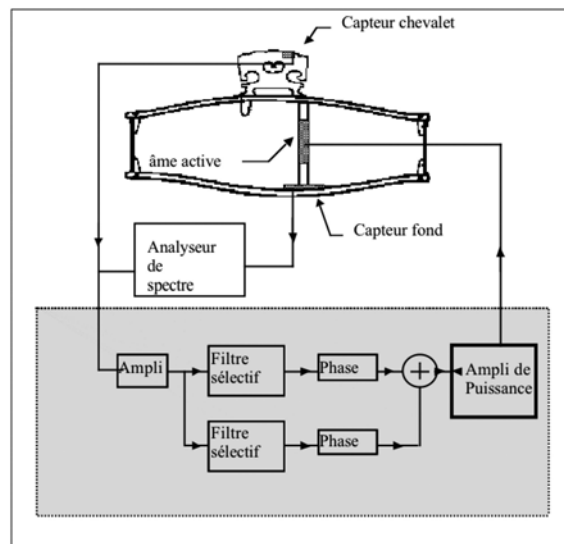

Figure 12. Activation of a violin via its soundpost.

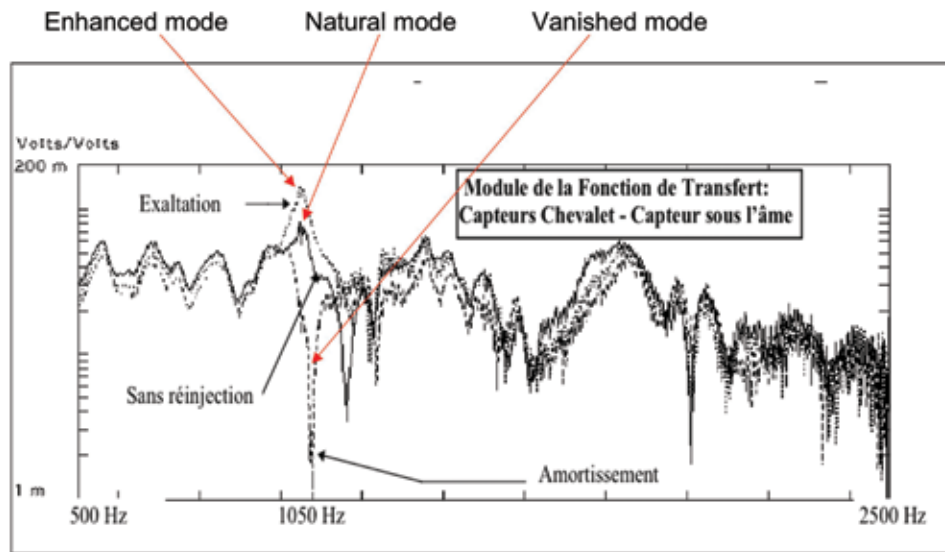

Figure 13. Modification of the transfer function of a violin to either enhance or diminish a particular mode.

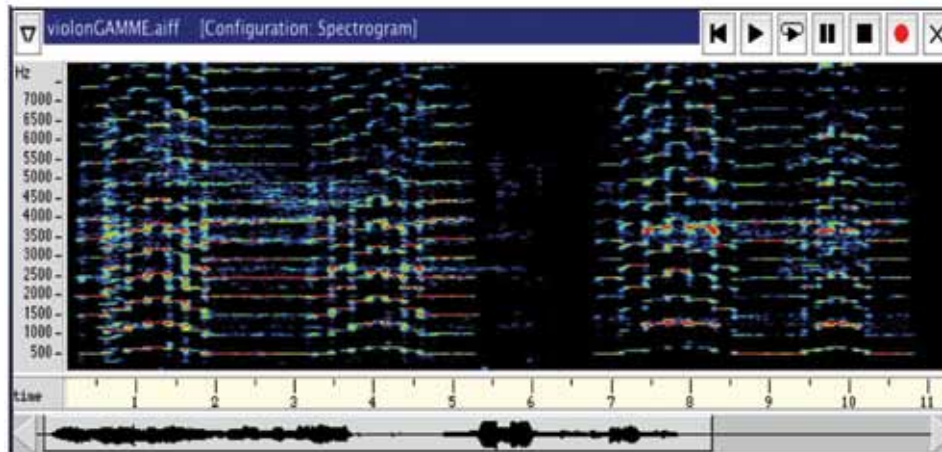

Figure 14. Spectrogram of a scale of a violin played without control and with control.

imposed on another broad peak like the measured admittance curve. When we average this curve over small frequency intervals, the resulting curve features a broad peak whose maximum depends on the mass and stiffness introduced in the bridge model. We use this calculation to estimate the frequency, amplitude, and bandwidth of the Bridge Hill (Fig. 19).

A simple mass-spring system has a resonance whose frequency, amplitude, and bandwidth depend on the mass, stiffness, and the damping coefficient. Those resonance characteristics can be modified by applying to the system a force depending on its velocity. To do that we needed a sensor to measure the system velocity, a controller to cal-

culate the desired force signal in real time from the sensor signal, and an actuator to apply the force on the system. As shown by the theoretical curves (Fig. 20), the controller coefficients allowed us to independently modify the amplitude, the bandwidth, and the frequency of the system resonance.

Obviously, controlling the resonances of a real bridge is much more challenging, since it has more resonances than a simple mass-spring system. However, as the rocking mode frequency is very different from the next higher modes, we still applied the feedback technique previously described. To do that, we introduced a sensor inside the bridge slightly above its heart plus two actuators in the ears of the bridge. Then we

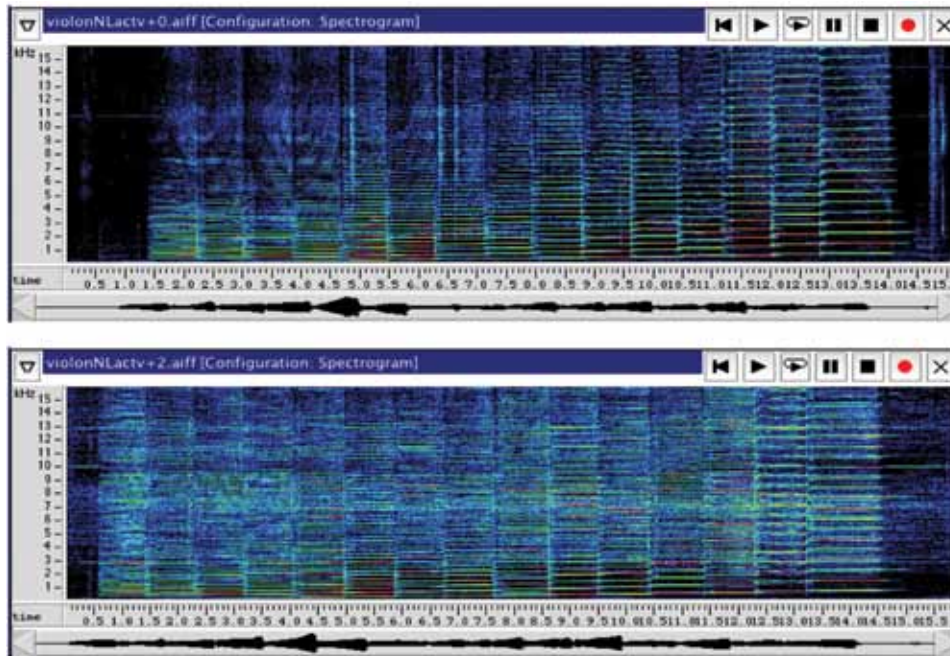

Figure 15. Enrichment of the spectra by nonlinear active control.

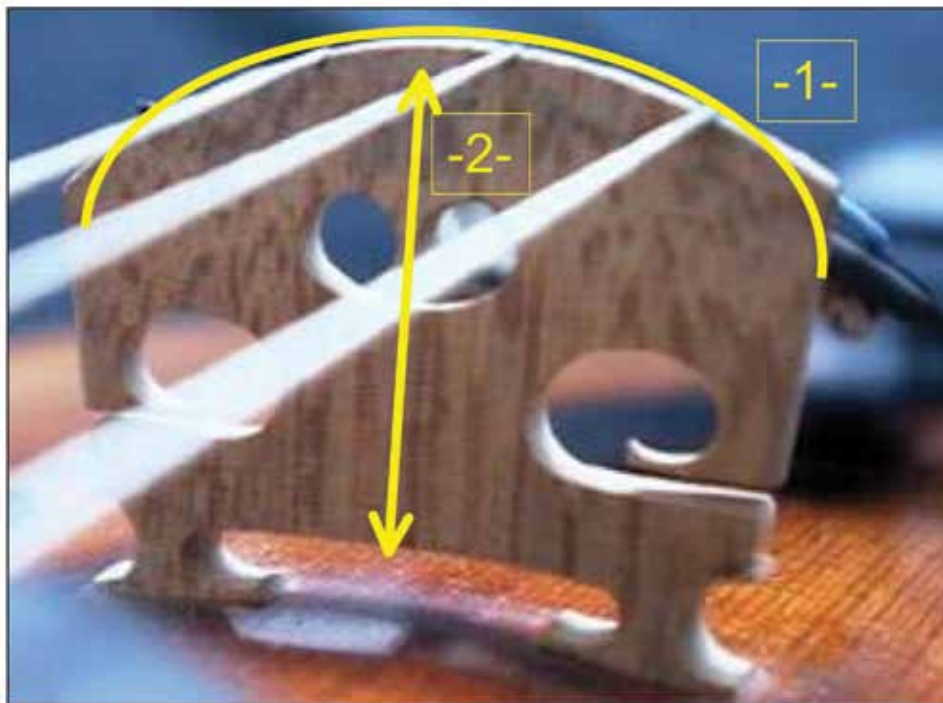

Figure 16. The violin bridge has two main vibration modes: 1) the rocking mode (~ 3 kHz) and 2) the bouncing mode (~ 6 kHz).

measured the bridge input admittance while it was removed from the instrument body (Fig. 21). The first peak of resonance at ~ 2.3 kHz corresponds to the rocking mode. It is significantly lower than

its usual location (~ 3 kHz), probably because the transducers increased the mass of the bridge.

Our objective was to modify this resonance with the bridge mounted on the instrument. The

$$Y_b = \text{velocity response to unit force amplitude}$$

$$= \frac{u_{\text{bridge}}}{F e^{j\omega t}}$$

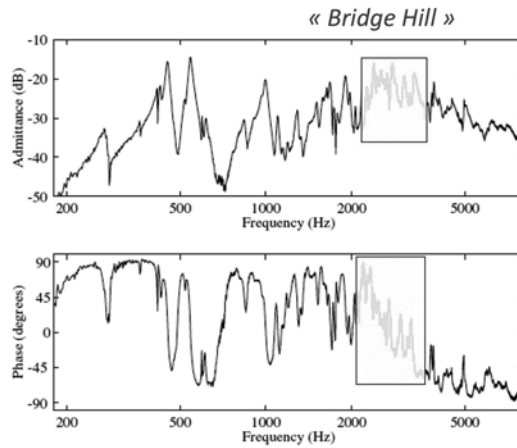
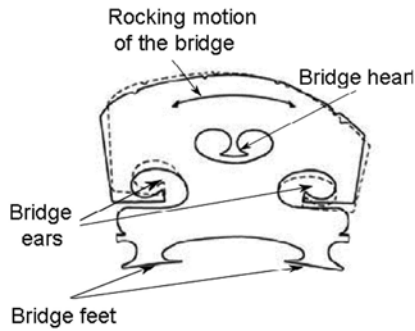

Input admittance of a real violin bridge

Figure 17. Spectra of the input admittance (velocity/applied force) of a real violin bridge.

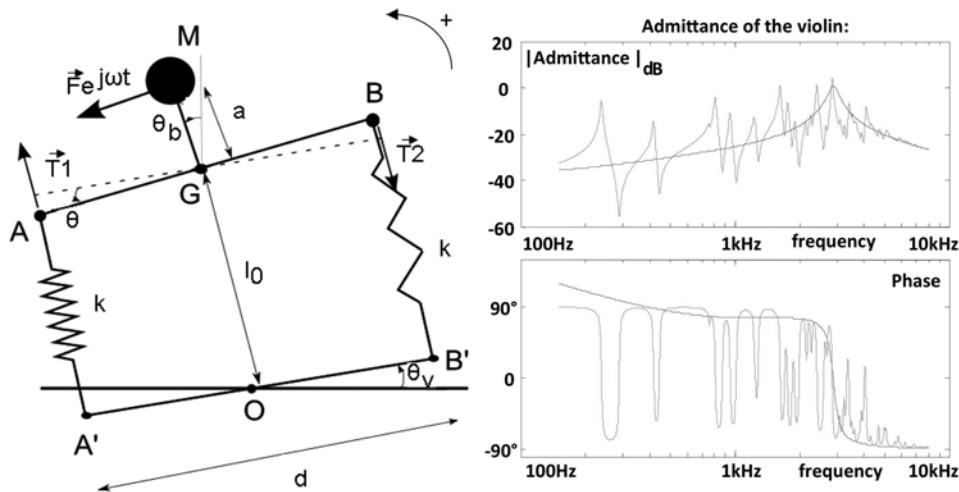

Figure 18. A simple theoretical model of a violin bridge connected (in A', O, and B') to a multi-modal system describing the violin body. The right-hand plot shows its input admittance.

violin we used was equipped with an active soundpost provided with a piezoelectric actuator. We applied a force at the soundpost and measured the velocity at the bridge. Although this transfer function is different from the violin's input admittance, it is also composed of resonance peaks corresponding to the body resonances. The Bridge Hill was observed as well and then the relative modifications of its characteristics, while applying the feedback force, could be measured on such a curve. The diagram of this active violin is described in Fig. 22.

To measure the transfer function we applied

a sinusoidal force sweeping the frequency range of interest, 2 to 6 kHz. The velocity at the upper part of the bridge was fed by the controller, which calculates in real time the force to apply to the actuators. The sensor signal, recorded and divided by the force at the soundpost, gave us the violin transfer function.

This curve was measured first without the controller (Fig. 23). Then we simulated the action of several controllers on the measured transfer function (Fig. 23, dotted lines), and for each we estimated the Bridge Hill (Fig. 23, solid line). We

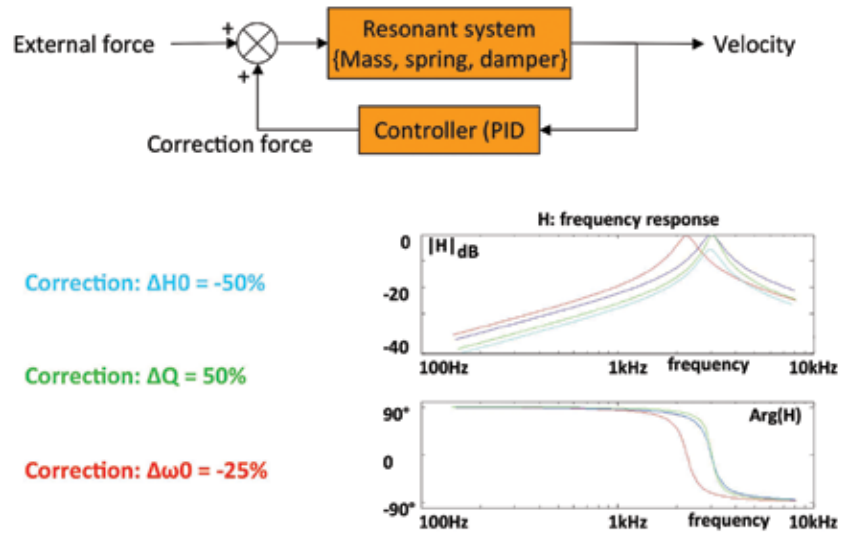

Figure 19. Frequency response of a second-order resonant system controlled by a feedback loop.

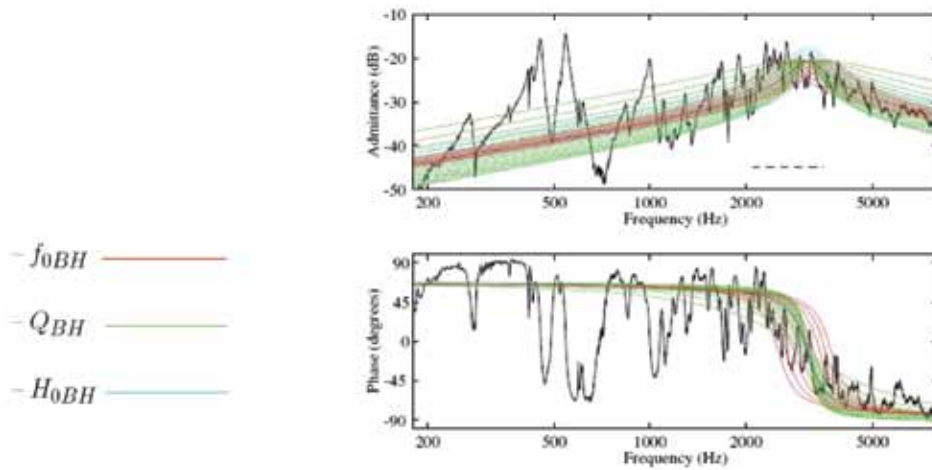

Figure 20. Modification of the frequency, bandwidth, and amplitude of the Bridge Hill by active control. These curves were obtained using the theoretical model.

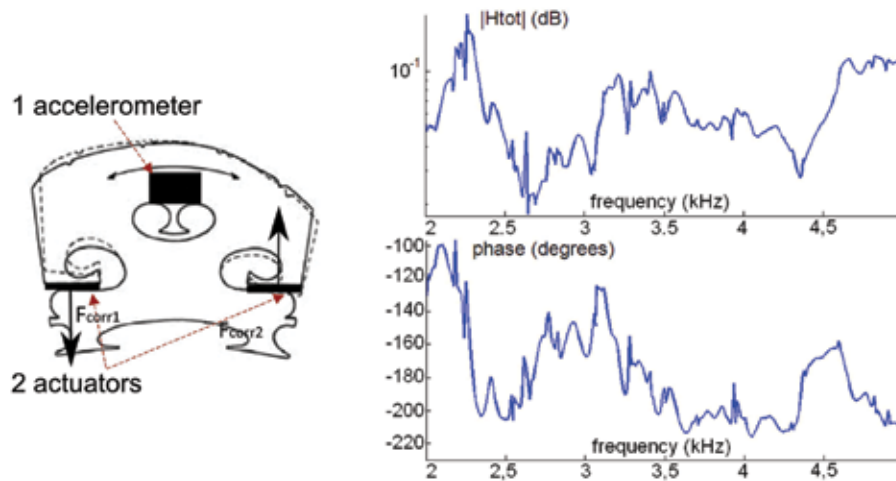

Figure 21. Measured transfer function of the active violin bridge between the actuators and the sensor.

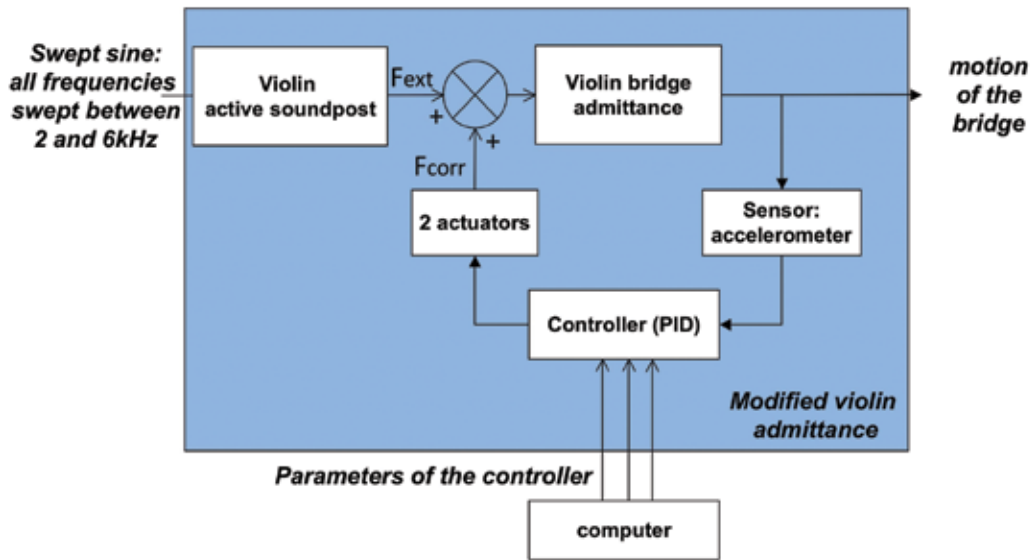

Figure 22. Diagram of the active violin used to measure the transfer function between the force applied at the soundpost and the velocity measured at the upper part of the bridge.

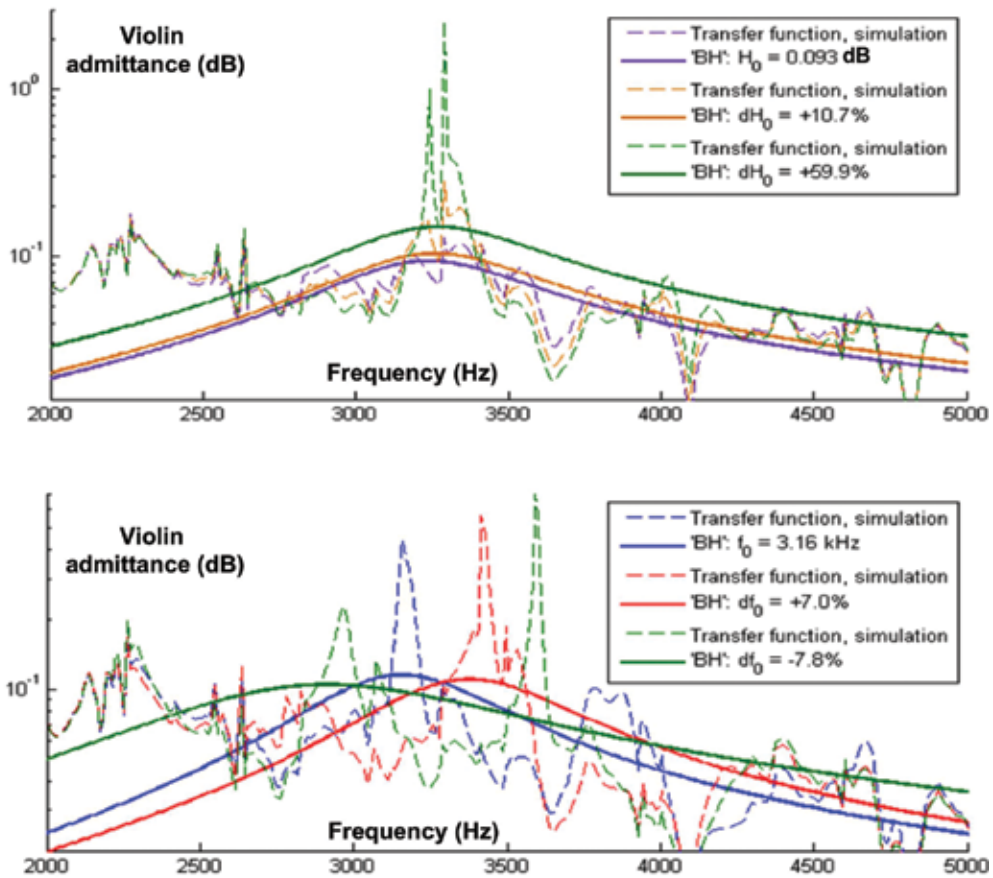

Figure 23. Examples of modified violin transfer functions obtained by simulation. The amplitude (upper curve) and the center frequency (lower curve) of the Bridge Hill were modified.

successively modified the maximum amplitude of the Bridge Hill (Fig. 23, upper plot) and its center frequency (Fig. 23, lower plot).

The next step consisted in evaluating the modifications applied to the real bridge transfer function for each controller. We first compared the frequency responses obtained from simulation (Fig. 24, dotted line) and from measurement with the real bridge (Fig. 24, solid line), while using two arbitrary controllers. For both experiments the measured results were close to the simulation curves. The curves obtained with the theoretical model seem to predict the modification of the real bridge response quite well.

Then we applied the controllers previously used in simulation to the real violin and measured the corresponding transfer functions. The curves in Fig. 25 show that such controllers enabled us to modify the Bridge Hill amplitude (upper curve) and frequency (lower curve).

More experiments were made with real playing conditions. The performer was asked to play four notes with different controllers, and the radiated sound was recorded with a microphone. First, we measured the impact on the radiated sound of a

controller that was set to increase the amplitude of the Bridge Hill. The spectrograms (Fig. 26) clearly show that the radiated sound had a high amplitude component around 3.5 kHz when the controller was added.

The subsequent experiments involved lowering and raising the Bridge Hill frequency. A high-amplitude component in the sound spectrogram (Fig. 27, upper plot) was measured in the first case at 3.4 kHz, and at 4.0 kHz in the second case (Fig. 27, lower plot). Those examples show that the sound spectrum of the violin can be modified by active control around the Bridge Hill frequency. Additional experiments need to be conducted with musicians to measure the impact of these modifications on the sound quality.

We brought with us the active violin we used to carry out these experiments. We'll play it with and without controller, and then ask the musician and you in the audience if you can hear differences in the sound.

The first condition is with is no correction of the bridge. [Plays violin]. Now, I'm going to apply a correction in amplitude. [Plays violin] Next, I have removed the controller, so now we hear the

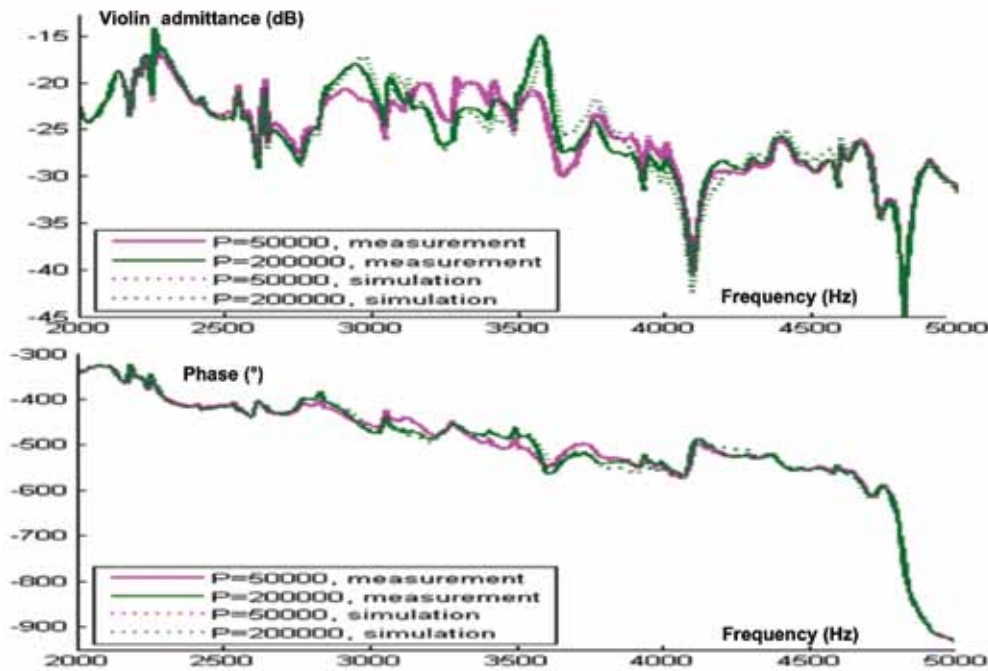

Figure 24. Comparison of simulated and measured violin bridge transfer functions (amplitude and phase versus frequency).

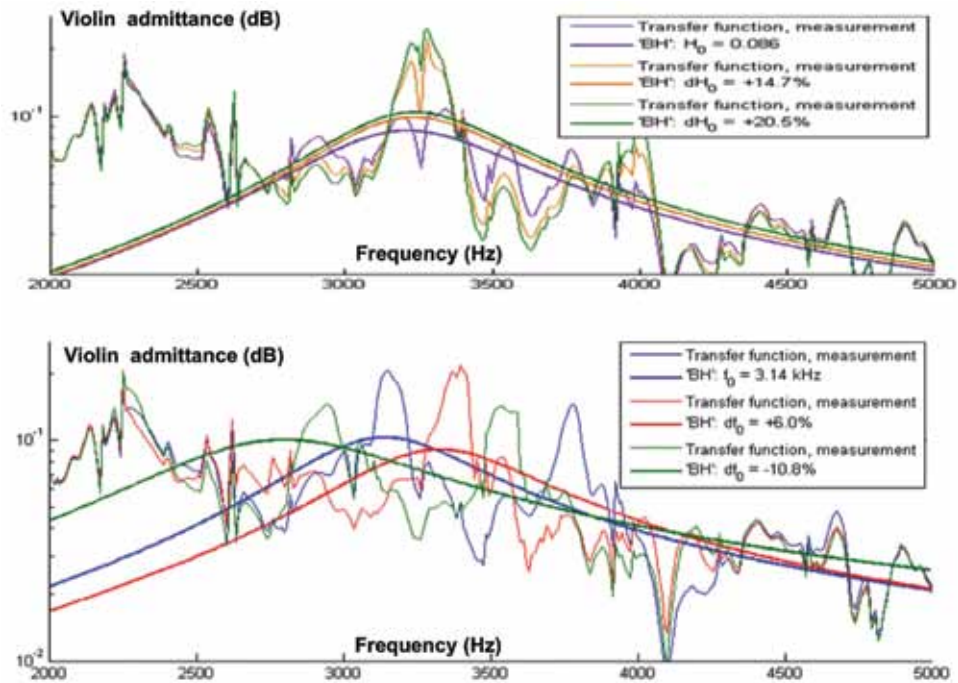

Figure 25. Measured violin transfer function while modifying the Bridge Hill amplitude (upper curve) and its center frequency (lower curve).

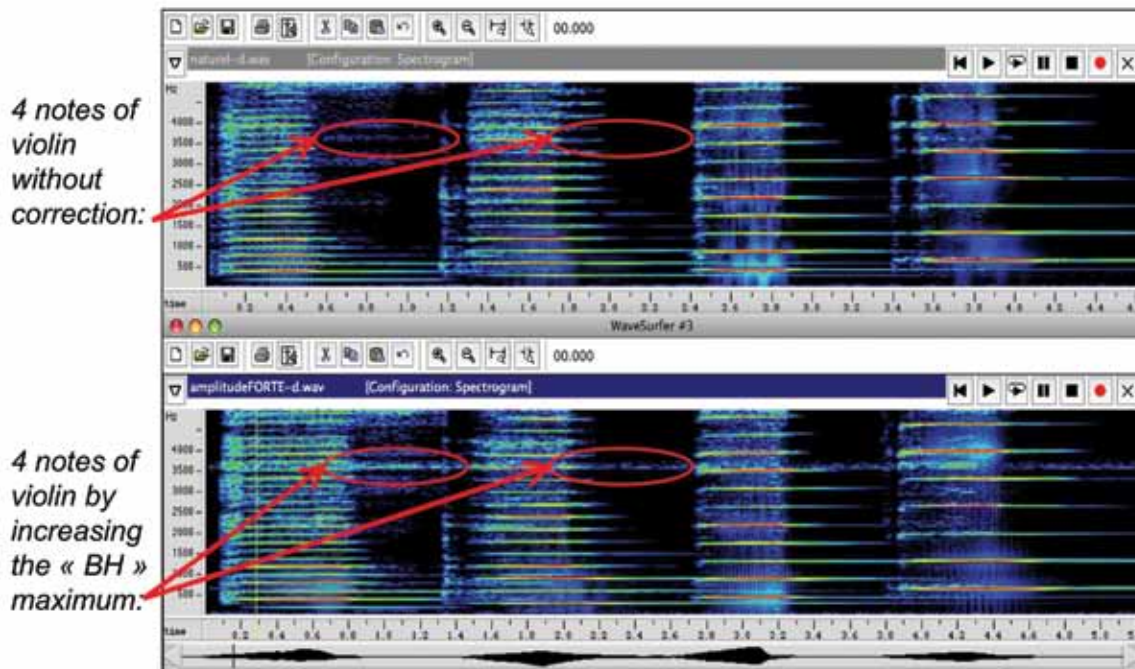

Figure 26. Spectrograms of the radiated sound obtained with (lower curve) and without (upper curve) the controller. The controller was used (lower curve) to increase the Bridge Hill amplitude at ~3.5 kHz.

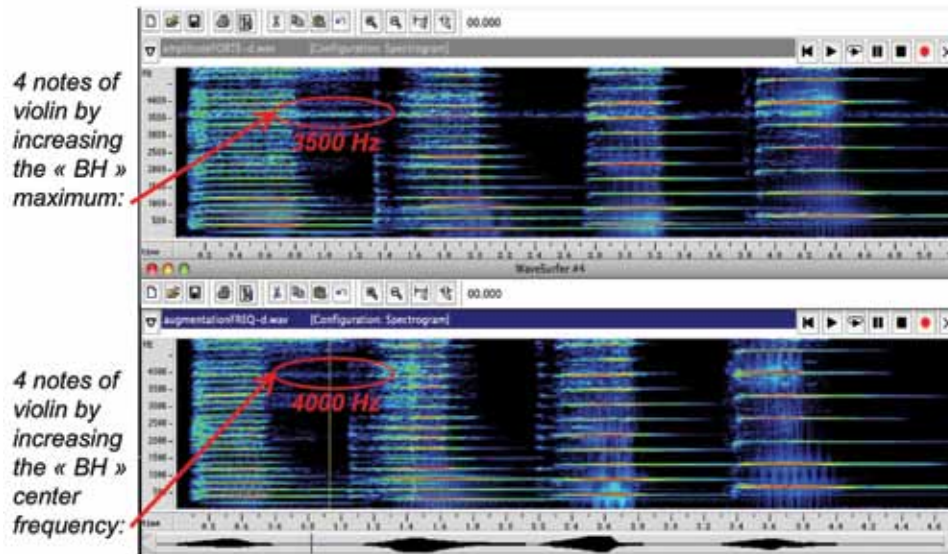

Figure 27. Spectrograms of the radiated sound obtained with two different controllers intended to lower (upper curve) and raise (lower curve) the Bridge Hill frequency (initially at 3.5 kHz).

natural sound. [Plays violin]

Mr. Tao: I notice that the tone quality of the violin that you're using is very poor. I would be very interested to hear the results with a much better sounding instrument.

Dr. Besnainou: The next step would be to try it on a Stradivari violin.

Mr. Tao: That would be quite interesting. We know from our many measurements of changes in setup with violins that the objective differences are actually quite small. Subjectively, however, the differences can be large and significant to the player who is very sensitive and attuned to the characteristics of his instrument. The problem when you do an experiment on such a poor instrument is that we're not really attuned to the subtleties of this really poor instrument.

Dr. Besnainou: If you are convinced, you could contact our team and try these experiments on a very good instrument. I am sure that a good instrument would be more sensitive. Our goal is to understand the know-how of the craftsman when he carves his bridge. Of course, it is very subtle.

Alan Copeland: The bridge that you used on the violin must be quite different from a normal bridge.

So when you do your normal state without feedback, that's already significantly modified from what a good bridge would do with that violin. Is that true, or does that bridge pretty well simulate a well-carved bridge?

Dr. Besnainou: No, this bridge is not a good bridge, of course. We use such a bridge because we know that when we block the ears by attaching the actuator, we drastically change the stiffness. If you have a good bridge, I don't know if it is very sensitive. We do have the ability to change the resonance frequency, the shape of the curves with the bandwidth, and the frequency response, so we can do as we want with a real bridge.

Dr. Copeland: You've convinced me that you can modify the character of the violin by doing what you're doing. The next step will be to determine if you can make it better by using the best bridge that a good bridge carver can make for this violin.

Dr. Besnainou: I can't answer that now, but it is a good idea. This type of device would be better in the hands of a craftsman who can make what he wants. We are not violinmakers, so we don't know what is interesting for the musician.

Mr. Tao: Thank you again, Charles and Henri.