



HAL
open science

A modal method adapted to the active control of a xylophone bar

Henri Boutin, Charles Besnainou

► **To cite this version:**

Henri Boutin, Charles Besnainou. A modal method adapted to the active control of a xylophone bar. Acoustics 2012, Apr 2012, Nantes, France. hal-03583419

HAL Id: hal-03583419

<https://hal.science/hal-03583419v1>

Submitted on 21 Feb 2022

HAL is a multi-disciplinary open access archive for the deposit and dissemination of scientific research documents, whether they are published or not. The documents may come from teaching and research institutions in France or abroad, or from public or private research centers.

L'archive ouverte pluridisciplinaire **HAL**, est destinée au dépôt et à la diffusion de documents scientifiques de niveau recherche, publiés ou non, émanant des établissements d'enseignement et de recherche français ou étrangers, des laboratoires publics ou privés.

A modal method adapted to the active control of a xylophone bar

Henri Boutin, Charles Besnainou

► **To cite this version:**

Henri Boutin, Charles Besnainou. A modal method adapted to the active control of a xylophone bar. Acoustics 2012, Apr 2012, Nantes, France. hal-00811148

HAL Id: hal-00811148

<https://hal.archives-ouvertes.fr/hal-00811148>

Submitted on 23 Apr 2012

HAL is a multi-disciplinary open access archive for the deposit and dissemination of scientific research documents, whether they are published or not. The documents may come from teaching and research institutions in France or abroad, or from public or private research centers.

L'archive ouverte pluridisciplinaire **HAL**, est destinée au dépôt et à la diffusion de documents scientifiques de niveau recherche, publiés ou non, émanant des établissements d'enseignement et de recherche français ou étrangers, des laboratoires publics ou privés.



ACOUSTICS 2012

A modal method adapted to the active control of a xylophone bar

H. Boutin and C. Besnainou

UPMC, IJLRDA, LAM, 15, rue de Lourmel, 75015 Paris, France
henriboutin@gmail.com

In Musical Acoustics, modal control is commonly used to modify the vibration characteristics of musical instruments. The number of transducers used to control the structures of such systems is typically reduced. In addition, their location is optimized, so as not to disturb the vibration of the instrument nor the musician playing.

In this paper, we suggest a control method adapted to these constraints. It allows modifying the characteristics of the peaks of resonance in the frequency response of the plant. This is achieved using a single pair of transducers. The controller is composed by a sum of second order resonant filters.

First we introduce the model of musical instruments we try to control. Then we describe the theoretical method used to calculate the coefficients of the controller. Over several simulations we succeeded in modifying the frequency and the amplitude of the first peaks of resonance in the frequency response of a xylophone bar.

1 Introduction

While applied to musical instruments, the theory of structural active control brings solutions to produce new sounds. Indeed it modifies the eigenmodes of the vibrating structure and then changes the acoustic characteristics of the sound. In the musical instruments provided with active controllers, the sound is radiated by the structure itself. Thus the interaction between the musician and the resonators is preserved. Then such instruments enable the musician to play new sounds with more expressivity than synthesizers.

The first musical instrument provided with a feedback loop was an electronic piano patented by Eisenmann [1] in 1893. It is fitted with some magnets placed close to the strings, which enable the instrumentist to change the damping of their vibration. Later the *EBow* and the *Sustainiac*, created by Heet [2] and Osborne & Hoover [3] respectively, allowed to extend the fundamental in the vibration of the guitar strings.

From 1995, Besnainou and co-workers [4, 5, 6, 7] applied modal control to resonators of many musical instruments by using piezoelectric transducers and *PID* controllers. They modified the characteristics of the Helmholtz resonance of the guitar, the lowest mode of the violin bridge and the first bending eigenmodes of the xylophone bar. This method was also used by Berdahl and Smith [8] to change the damping of the partials in the vibration of an electric guitar string.

A *PID* controller affects the frequency response of a vibrating structure over a large bandwidth and then can make some eigenmodes unstable. Consequently other types of controllers were suggested in order to overcome that point. In particular Rollow [9] introduced a *feedforward* controller which guarantees the loop stability, and used it to change the damping of the first mode of an experimental drum. Later Berdahl and Smith [10] developed an *RMS level tracking controller* adapted to the guitar strings. It imposes the amplitude of its partials and thus prevents them from diverging.

Unlike the *PID*, the controller suggested here is intended to modify the characteristics of the desired resonances of a musical instrument without changing the other ones. First we describe the considered system by a non-parametric model. Then we introduce the method

to determine the controller coefficients. It is applied to a model of xylophone bar made of composite material.

2 Model of musical instrument

In active control of musical instruments, the amount of transducers is typically reduced so as not to disturb the structure vibration nor the musician playing. Thus the considered system is outfitted with only one sensor and one actuator. In musical instruments the geometric and physical properties of the structure are usually complex, so that it is often hard to establish a realistic analytical model. Consequently we develop a non-parametric *input-output* model, characterized by its frequency responses. The considered system has two inputs: the force of the instrumentist, F_1 , and the force generated by the actuators, F_{act} . In general they are not collocated. The output is the measurement signal provided by the sensor, called Y . Thus the system is described by two frequency responses: $G_1 = Y/F_1|_{F_{act}=0}$ and $G_2 = Y/F_{act}|_{F_1=0}$. Y is the sum of both input signals, filtered by G_1 et G_2 respectively, cf. fig.1.

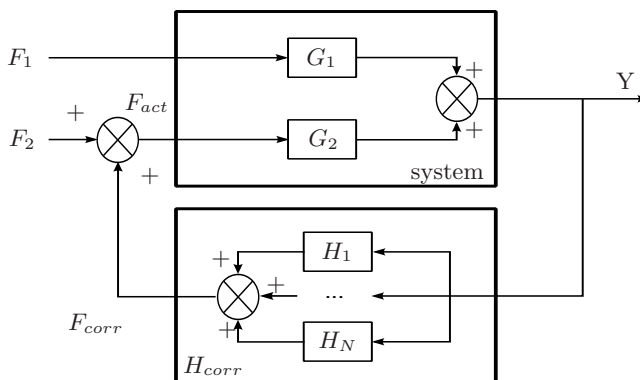

Figure 1: Diagram of the closed-loop system, described by the frequency responses G_1 and G_2 and by the controller response H_{corr} .

The suggested method consists in placing a controller in the feedback loop, between the sensor and the actuator, in order to modify the resonances of the closed-loop system. In general, the frequency response G_1 depends on the characteristics of the force applied by the instrumentist, so that it is not always the same. Unlike G_1 , the frequency response G_2 is totally known since the actuator position is chosen. Then the controller coefficients are determined in order to modify the resonance

peaks of the curve $Y/F_2|_{F_1=0}$, which does not depend on G_1 .

The frequency response of the transducers and the delay introduced by the controller in the feedback loop in case it is digital are not mentioned in the figure 1. Indeed, they are taken into account in the responses G_1 and G_2 . Thus, since the controller coefficients are chosen in order to modify the resonances of G_2 , the presence of the transducers and the possible controller delay do not disturb the variations applied to the closed-loop system.

In the sequel the frequency response G_2 is assumed to be a sum of resonance peaks which characterize the amplitude, the frequency and the decay of the partials in the radiated sound. Such a model is especially adapted to percussion instrument. As an example, we try to control the vibration of a xylophone bar in composite material. It was made by Charles Besnainou in the LAM (Laboratoire d'Acoustique Musicale) in 1995, and then studied by Chaigne & al [11]. It is outfitted with one sensor and two piezoelectric actuators in *PVDF* fed by the same voltage, cf. fig.2.

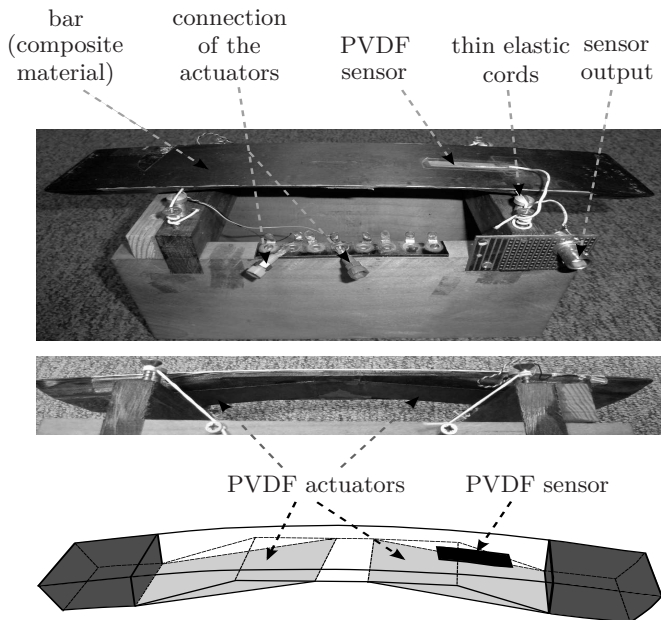

Figure 2: Xylophone bar made of composite material provided with piezoelectric transducers.

The measured frequency response of the xylophone bar \tilde{G}_2 and the estimate given by an *ARMA* filter G_2 were obtained through previous studies [12]. They make up two models of the system {xylophone bar + transducers}. They are shown between 100 Hz and 3.2 kHz, cf. fig.3. The order of the *ARMA* filter, equal to 8, is sufficient to identify the characteristics of the four main resonance peaks in the considered frequency range. The two higher peaks, 1 and 4, correspond to the first bending modes of odd order. The peaks 2 and 3 may be due to the actuators position, which is not perfectly symmetric with respect to the middle of the bar.

The i^{th} resonance of G_2 is characterized by the position of the peak, $\omega_i = 2\pi f_i$, its amplitude G_{max_i} , its

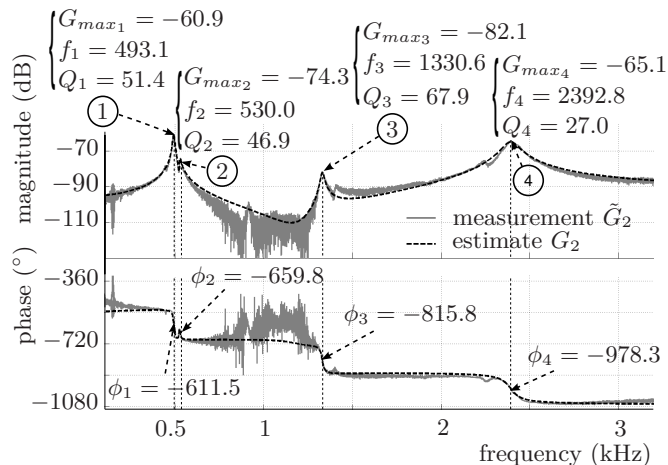

Figure 3: Measurement \tilde{G}_2 and estimate G_2 of the frequency response of the system {xylophone bar + transducers}.

width and the phase $\phi_i = \arg(G_2(j\omega_i))$. The width of the peak can be described by the -3 dB bandwidth $\Delta\omega_i$, and by the estimated quality factor $Q_i = \omega_i/\Delta\omega_i$, provided the distance to the contiguous peaks is large enough. The parameters of the first four peaks of G_2 are assessed, cf. fig.3, since they are useful to calculate the controller coefficients.

The controller is made up by N bandpass filters of second order, which transfer functions are:

$$H_i(s) = \frac{H_{c_i} s}{Q_{c_i} \omega_{c_i}} \frac{e^{-j\phi_{c_i}}}{1 + \frac{s}{Q_{c_i} \omega_{c_i}} + \left(\frac{s}{\omega_{c_i}}\right)^2}, \quad 1 \leq i \leq N \quad (1)$$

where s is the Laplace variable, H_{c_i} is the maximum value reached by the filter, ω_{c_i} its natural frequency and Q_{c_i} its quality factor. The ϕ_{c_i} parameter in the expression of H_i is used to change the phase difference between the system output signal and the signal generated by the filter. The amount of filters chosen in the controller, N , is equal to the quantity of resonance peaks we want to modify. The transfer function of the controller is the sum $H_{corr} = \sum_{i=1}^N H_i$. The closed-loop system is shown on figure 1. The coefficients of H_i depend on the characteristics of the corresponding peak of G_2 and also on the relative variations we hope to apply. The relative variations of amplitude, frequency and bandwidth are called η_{G_i} , η_{ω_i} and $\eta_{\Delta\omega_i}$ respectively. They are greater than -1 .

We have described in this paragraph a model of the system {musical instrument + transducers}. According to the diagram of figure 1, its closed-loop frequency response is:

$$G_{BF} = Y/F_2|_{F_1=0} = \frac{G_2}{1 - G_2 \times H_{corr}} \quad (2)$$

As H_{corr} is a sum of bandpass filters of order 2, its magnitude tends to zero when ω moves away from the frequencies ω_{c_i} , and then $G_{BF} \rightarrow G_2$. Consequently the frequency response is unchanged beyond the considered peaks of resonance. The following paragraph describes the method to determine the controller coefficients.

3 Theoretical method

The purpose of the required controller is to modify the amplitude, the frequency and the bandwidth of the desired peaks of resonance of the considered system. The variations we wish to apply have to be independent of one another. To do that, we first try to modify the amplitude of one peak of G_2 without changing its frequency. Then we allocate some desired values to its frequency and its amplitude simultaneously. At last we try to modify the bandwidth of the considered peak while leaving the amplitude and the frequency unchanged. In each case, the controller is applied to the model described by the frequency response G_2 . As it discloses few resonances, cf. fig.3, this model allows us to discuss the controller performance easily. Lastly the controller is used to modify the tuning of the system {xylophone bar + transducers} described by the measured frequency response \tilde{G}_2 .

a- modification of amplitude. The controller we use in order to modify the i^{th} peak is made up by only one filter H_i . Its natural frequency ω_{c_i} is set equal to ω_i . Then, the phase coefficient of H_i is chosen so that $G_2 \times H_{corr}$ is real in ω_i . In this case the denominator of G_{BF} at this frequency is real as well. To do that, ϕ_{c_i} is set equal to $\arg(G_2(j\omega_i)) + 2k_i\pi$, where k_i is the smaller integer such as $\phi_{c_i} \geq 0$. In these conditions, the choice of the H_{c_i} coefficient enables to allocate the desired value to the magnitude $G_{BF}(j\omega_i)$, provided the amplitude of the contiguous filters $|H_{i-1}|$ and $|H_{i+1}|$ are negligible in ω_i . Indeed, if $H_{c_i} = \frac{1}{|G_2(j\omega_i)|} \frac{\eta_{G_i}}{1+\eta_{G_i}}$, then

$$G_{BF}(j\omega_i) = (1 + \eta_{G_i}) \times G_2(j\omega_i) \quad (3)$$

Therefore the amplitude of the i^{th} peak is subjected to the relative variation η_{G_i} .

The bandwidth of the considered peak in the frequency response G_{BF} depends on the damping of the filter H_i . Thus it can be adjusted by changing the value of its quality factor. For practical purposes, we initially choose Q_{c_i} equal to the ratio of ω_i to $\Delta\omega_i$, provided the -3 dB bandwidth can be assessed, i.e. the distance to the contiguous peaks is large enough. Then its value is increased or reduced in order to modify the bandwidth of the peak of the closed-loop system, as shown by the simulations of paragraph 3c.

In the model {xylophone bar + transducers} described by G_2 , we modify the amplitude of the first resonance peak from -50% to 300% , cf. fig.4. In this simulation, Q_{c_i} is equal to the estimated quality factor $\omega_1/\Delta\omega_1 = 51.4$. In the closed-loop system the peak frequency is unchanged and its amplitude is exactly equal to the expected value. The closest peak, located in 530 Hz, is not significantly modified. In the case $\eta_{G_1} = -50\%$, the desired variation is so small that the first peak becomes a local minimum. We explain in the paragraph 3c how to overcome this disadvantage.

To sum up, the filter H_i of the corrector assigns the desired amplitude to the i^{th} peak of G_{BF} without modifying its frequency. The minimum amplitude variation

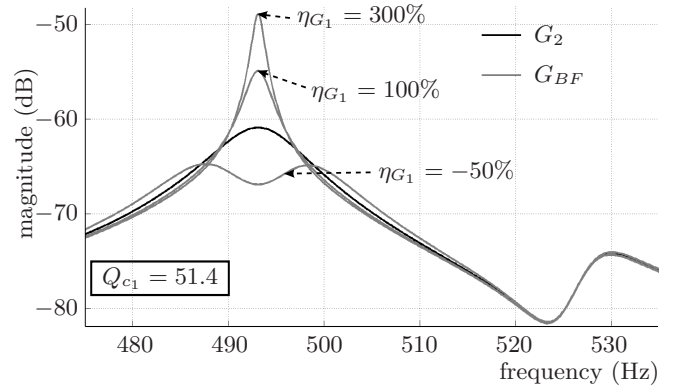

Figure 4: Modification of the amplitude of peak 1 in the system described by G_2 .

which can be applied depends on the initial damping of the peak and on the distance to the contiguous peaks.

b- modification of frequency. In this paragraph we try to modify simultaneously the amplitude and the frequency of the i^{th} peak of the system. To do that, we set the natural frequency of H_i equal to the desired frequency $\omega_{c_i} = \omega_i(1 + \eta_{\omega_i})$. Then we choose the ϕ_{c_i} coefficient so that $G_2 \times H_{corr}$ is real at this frequency: $\phi_{c_i} = \arg(G_2(j\omega_{c_i})) + 2k_i\pi$, where k_i is the smaller integer such as $\phi_{c_i} \geq 0$. Then, in order to assign the desired value to the magnitude $|G_{BF}(j\omega_{c_i})|$:

$$H_{c_i} = \frac{1}{|G_2(j\omega_{c_i})|} - \frac{1}{|G_2(j\omega_i)|(1 + \eta_{G_i})} \quad (4)$$

In these conditions,

$$G_{BF}(j\omega_{c_i}) = \frac{G_2(j\omega_{c_i})}{1 - |G_2(j\omega_{c_i})| H_{c_i}} \quad (5)$$

$$= (1 + \eta_{G_i}) |G_2(j\omega_i)| e^{j \arg(G_2(j\omega_{c_i}))} \quad (6)$$

The amplitude of the considered peak is increased in the closed-loop response means that η_{G_i} is positive and then, from eq.(4):

$$H_{c_i} > \frac{1}{|G_2(j\omega_{c_i})|} - \frac{1}{|G_2(j\omega_i)|} \quad (7)$$

Moreover, while H_{c_i} is less than $1/|G_2(j\omega_{c_i})|$, from eq.(5), the magnitude $|G_{BF}(j\omega_{c_i})|$ can get any positive value.

With the filter H_i as a controller, the i^{th} peak is not exactly located at the desired frequency in the closed-loop response. The position error depends on the bandwidth of H_i and thus on its quality factor Q_{c_i} . In the case $H_{c_i} > 0$, the magnitude $|G_{BF}|$ is increased at the frequency ω_{c_i} . Then the considered peak is all the closer to the desired frequency so the value of Q_{c_i} is large. However in these conditions, the magnitude $|H_i|$ of the controller decreases at the frequency ω_i and the initial peak of G_{BF} is less reduced.

In the model {xylophone bar + transducers} described by the G_2 response, we try to increase the amplitude of the fourth peak by 100% , and to modify its frequency

first by -29.3% (three tones), and then by $+5.9\%$ (one semi-tone), cf. fig.5. Thus its expected value is 1692.0 Hz with the first controller, and 2535.2 Hz with the second one.

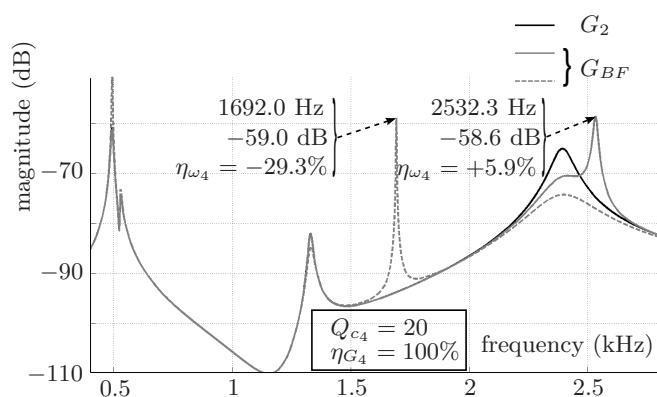

Figure 5: The controllers are intended to modify the frequency of the fourth resonance peak of the system by -29.3% and $+5.9\%$, and to increase the amplitude by $+100\%$, i.e. $+6.0$ dB.

In this simulation, the quality factor of each controller is $Q_{c_4} = 20$ and was chosen empirically. With the first controller the frequency of the fourth peak is equal to the desired value and its amplitude is 0.1 dB too high. With the second controller, the differences between these measured characteristics and the expected values are equal to 0.5 dB for the amplitude and 2.8 Hz (i.e. 0.11%) for the frequency. These errors may have been reduced by using a larger quality factor Q_{c_4} . Moreover in the case $\eta_{\omega_i} = -0.293$, the peaks 1, 2 and 3 are modified significantly on the one hand, and the amplitude of the initial peak is not totally reduced on the other hand. Therefore, Q_{c_4} can hardly be optimized.

As a conclusion the controller allowed us to modify the frequency of a resonance peak independently of its amplitude. However while the variation $|\eta_{\omega_i}|$ is increased, the initial peak is less reduced in the closed-loop response G_{BF} . Moreover the errors between the measured characteristics and the expected values are larger, and the contiguous peaks are more disturbed.

c- modification of bandwidth. The choice of the coefficients ω_{c_i} and H_{c_i} allowed the controller to allocate the desired amplitude and frequency to the i^{th} peak of G_{BF} , provided the distance with the contiguous peaks is large enough. Once these parameters are set, the quality factor Q_{c_i} can still be modified to change the bandwidth of the peak. While its value is increased (respectively reduced), the magnitude G_{BF} of the closed-loop system is modified over a narrower (respectively wider) frequency range. Consequently in the case the amplitude of the i^{th} peak is increased and the frequency is unchanged, i.e. $\omega_{c_i} = \omega_i$ and $H_{c_i} > 0$, Q_{c_i} must be reduced to extend its bandwidth in the closed-loop response, cf. fig.6a.

In the next simulation, the first peak of G_2 is subjected to the amplitude variation $\eta_{G_1} = +100\%$ and its frequency is not modified: $\eta_{\omega_1} = 0$. Thus the coefficient

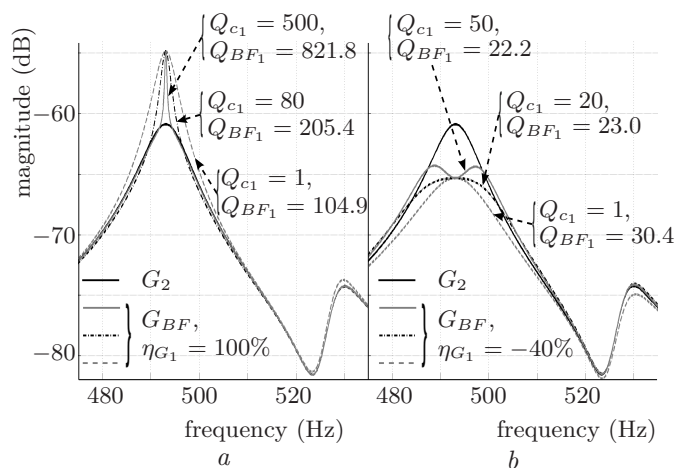

Figure 6: The controllers are intended to modify the bandwidth of peak 1, namely Δ_{ω_1} , and to increase its amplitude by $+100\%$ first (a), and to reduce it by 40% (b) then. Its frequency is unchanged. The quality factor Q_{BF_1} is estimated by the $\omega_1/\Delta_{\omega_1}$ ratio.

$H_{c_i} > 0$. The different values given to the quality factor Q_{c_i} cause modifications of the bandwidth. However it is upper bounded by its initial value. Moreover the amplitude variation and the frequency of the considered peak are unchanged. Last we observe that the characteristics of the second peak of G_{BF} are more disturbed as Q_{c_i} is small. In these conditions, the eigenmodes corresponding to the other resonance peaks can become unstable.

In the case $\eta_{\omega_i} \neq 0$, the amplitude and the frequency of the i^{th} peak in the closed-loop response depend on the Q_{c_i} value. Their distance to the expected values is reduced while Q_{c_i} is increased. However the amplitude of the initial peak is then less attenuated, cf. fig.5 when $\eta_{\omega_4} = -29.3\%$.

Unlike the previous case, when $H_{c_i} < 0$, the decrease of Q_{c_i} causes the reduction of the bandwidth of the i^{th} peak in the closed-loop response, cf. fig.6b. Now the variations applied in simulation are $\eta_{G_1} = -10\%$ and $\eta_{\omega_1} = 0$. Such a situation involves $H_{c_1} < 0$. We notice that the reduction of Q_{c_1} makes the bandwidth of the peak narrower, and that Δ_{ω_1} is lower bounded by its initial value. Moreover the Q_{c_1} value has to be small enough to prevent the peak from becoming a local minimum at the frequency f_1 , cf. fig.6b when $Q_{c_1} = 50$.

Obviously the case $H_{c_i} = 0$ causes $H_i = 0$ and then the bandwidth is unchanged.

In summary once the desired values are given to the amplitude and the frequency of the i^{th} peak of G_{BF} , its bandwidth can still be modified. However its variation depends on the sign of H_{c_i} , and then on the desired variation of the amplitude.

d- application to the xylophone bar. Now we try to modify the measured frequency response \tilde{G}_2 of the system {xylophone bar + transducers}, cf. fig.7. Our purpose is to change its tuning. To do that we suggest

increasing the amplitude of peaks 1 and 4 by 100%, leaving unchanged the frequency of the first one, and positioning the fourth peak in $2^{28/12} \times f_1 = 2468.9$ Hz. This way the interval between the considered peaks would be exactly two octaves plus a major third. The coefficients of each filter H_i are determined by using the previous method. Finally the controller is the sum of these filters.

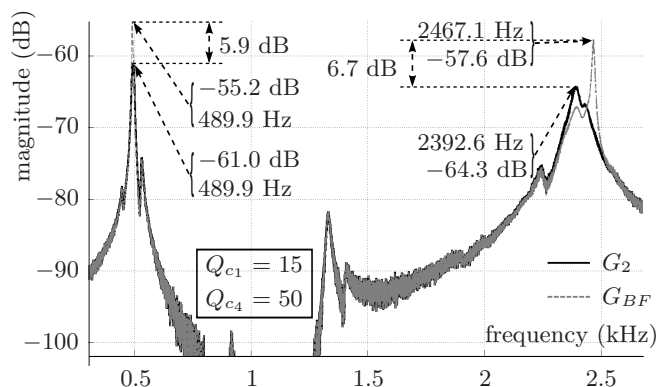

Figure 7: The controller is intended to increase the amplitude of peaks 1 and 4 by 100% (i.e. +6.0 dB) and to place the fourth peak in 2468.9 Hz. We chose the quality factors Q_{c_1} et Q_{c_4} after several simulations so as not to modify the other peaks of \tilde{G}_2 .

In this simulation, the errors of amplitude and frequency are less than 0.7 dB and than 0.1% respectively. They would be smaller if the Q_{c_4} coefficient were greater, but then the initial peak in 2.39 kHz would be less attenuated. As the sound radiated by the system {xylophone bar + transducers} is made up by several powerful partials such errors are hardly perceptible, cf. Zwicker et Fastl [13].

4 Conclusion

The suggested method of active control allowed us to modify the resonance characteristics of a structure by using only one pair of transducers. To do that it uses a non-parametric model, characterized by its frequency responses. Such a model is easy to set up even if the geometric and physical properties of the system are complex.

The magnitude of the suggested controller tends to 0 when the frequency moves away from the considered peaks. Consequently it modifies their characteristics without disturbing the contiguous peaks. For these reasons the method is adapted to control the vibration of multimodal structures in musical instruments.

Over simulations we allocated some desired values to the amplitude and to the frequency of different peaks of resonance. We succeeded in modifying a resonance frequency by several tones. Some modifications of bandwidth were also achieved but they depended on the chosen variations of amplitude. While the peaks of resonance are far enough from each other, the differences between the desired characteristics and the expected values are not significant. For each simulation the impulse response of the closed loop system was calculated, so that we can listen to the modifications obtained in the

radiated sound.

In the case the system is real, the response of the transducers and the delay generated in the feedback loop by the digital processor can be assessed. Thus the suggested method enables to take these features into consideration in the calculation of the controller coefficients. Consequently it should be readily applied to real musical instruments.

References

- [1] R. Eisenmann, "Musical instrument", *United States Patent Office* **496.402**, (1893)
- [2] G.S. Heet, "String instrument vibration initiator and sustainer", *United States Patent Office* **4.075.921**, (1978)
- [3] G.T. Osborne, A.A. Hoover, "Sustainer for a musical instrument", *United States Patent Office* **5.932.827**, (1999)
- [4] C. Besnainou, "Modal stimulation: a sound synthesis new approach", *proceedings of ISMA '95*, 434-438 (1995)
- [5] R. Chollet, G. Aeberli, C. Besnainou, "Modification de la résonance de Helmholtz de la guitare par contrôle actif" *proceedings of CFA '00*, 248-250 (2000)
- [6] H. Boutin, C. Besnainou, "Physical parameters of the violin bridge changed by active control", *proceedings of Acoustics'08* **123**(5), 3656-3656 (2008)
- [7] H. Boutin, C. Besnainou, "Physical parameters of an oscillator changed by active control: application to a xylophone bar", *proceedings of DAFX'08*, 173-176 (2008)
- [8] E. Berdahl, J.O. Smith and A. Freed "Active damping of a vibrating string", *proceedings of ACTIVE'06* (2006)
- [9] J.D. Rollow, *Active control of spectral detail radiated by an air-loaded impacted membrane*, PhD thesis, Pennsylvania State University (2003)
- [10] E. Berdahl, J.O. Smith, "Inducing unusual dynamics in acoustic musical instruments", *proceedings of CCA '07*, 1336-1341 (2007)
- [11] A. Chaigne, M. Bertagnolio, C. Besnainou, "Tuning of xylophone bars: influence of curvature and inhomogeneities", *proceedings of ISMA '01* **2**, 531-534 (2001)
- [12] H. Boutin, *Méthodes de contrôle actif d'instruments de musique. Cas de la lame de xylophone et du violon.*, PhD thesis, UPMC, Univ. Paris VI, IJLRDA, LAM team, Paris (2011)
- [13] E. Zwicker, H. Fastl, *Psycho-acoustics - facts and models*, Springer-Verlag, 2nd Edition, Berlin Heidelberg (1999)