

Functional packaging of RF, mmW and photonic functions based on femtosecond laser micromachining

E. Dubois¹, A. Bhaskar^{1,2}, J.M. Boucaud^{1,2}, A. Alves¹, C. Belem^{1,2},
F. Braud¹, E. Okada¹, V. Avramovic¹, J.F. Robillard¹, C. Durand²,
F. Gianesello², D. Bucci³, J.E. Broquin³, C. Gaquière¹, D. Gloria²

¹ IEMN-CNRS, Avenue Poincaré, F-59652 Villeneuve d'Ascq

² STMicroelectronics, 850 Rue Jean Monnet, F-38920 Crolles

³ IMEP-LAHC, Parvis Louis Néel, F-38016 Grenoble

1

Functional Packaging: context and objectives

2

Electro-Optical Packaging for Silicon Photonics

3

Packaging for mmW and sub-THz electronics

4

Improved RF SOI-CMOS using laser substrate engineering

5

Perspectives - Summary & Roadmap

Functional Packaging: Context & Objectives

System Moore Paradigm

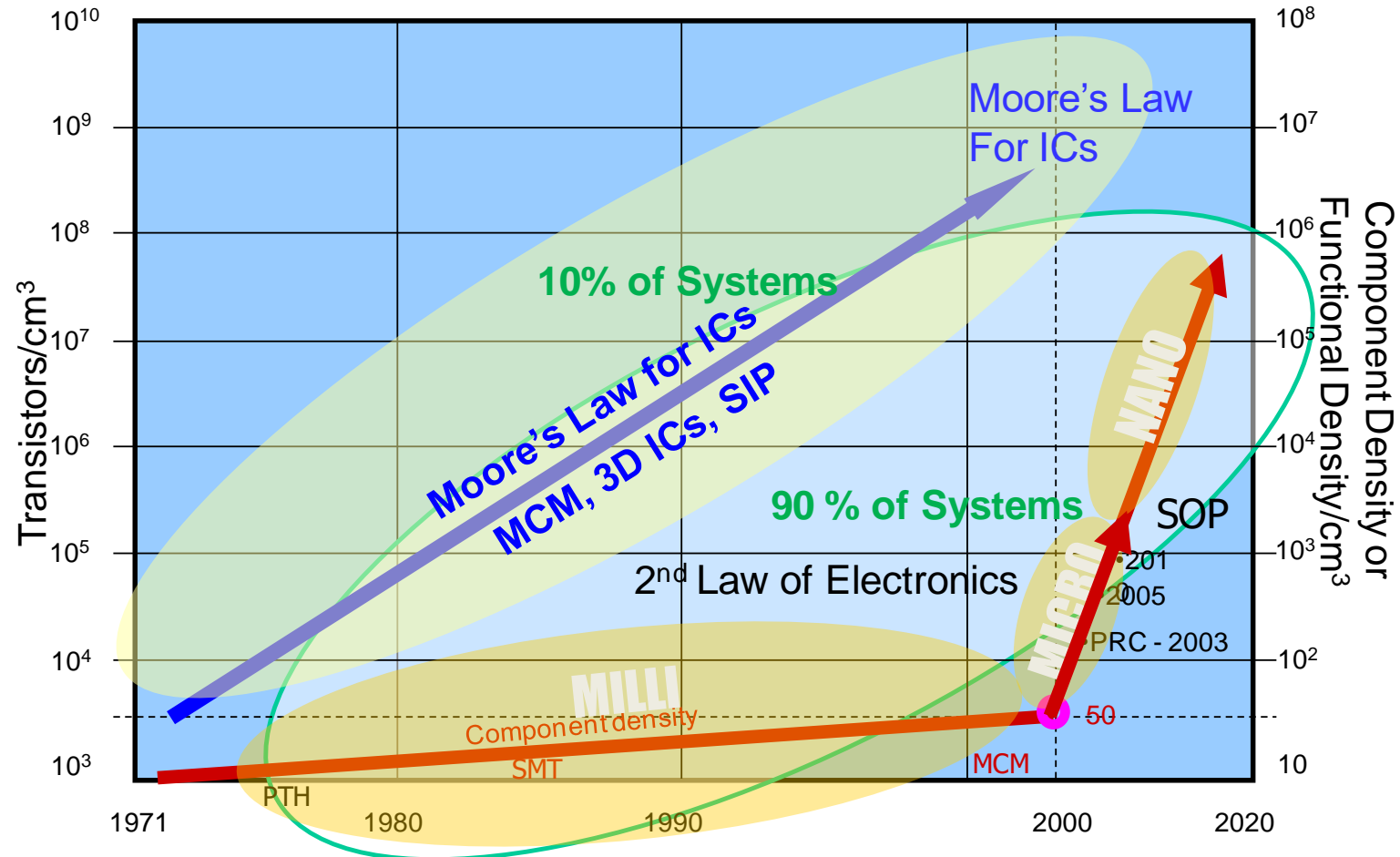

Sources: IBM, Intel

R. Tummala, System-On-Package (SOP) Mc Graw-Hill 2008

Functional Packaging: Context & Objectives

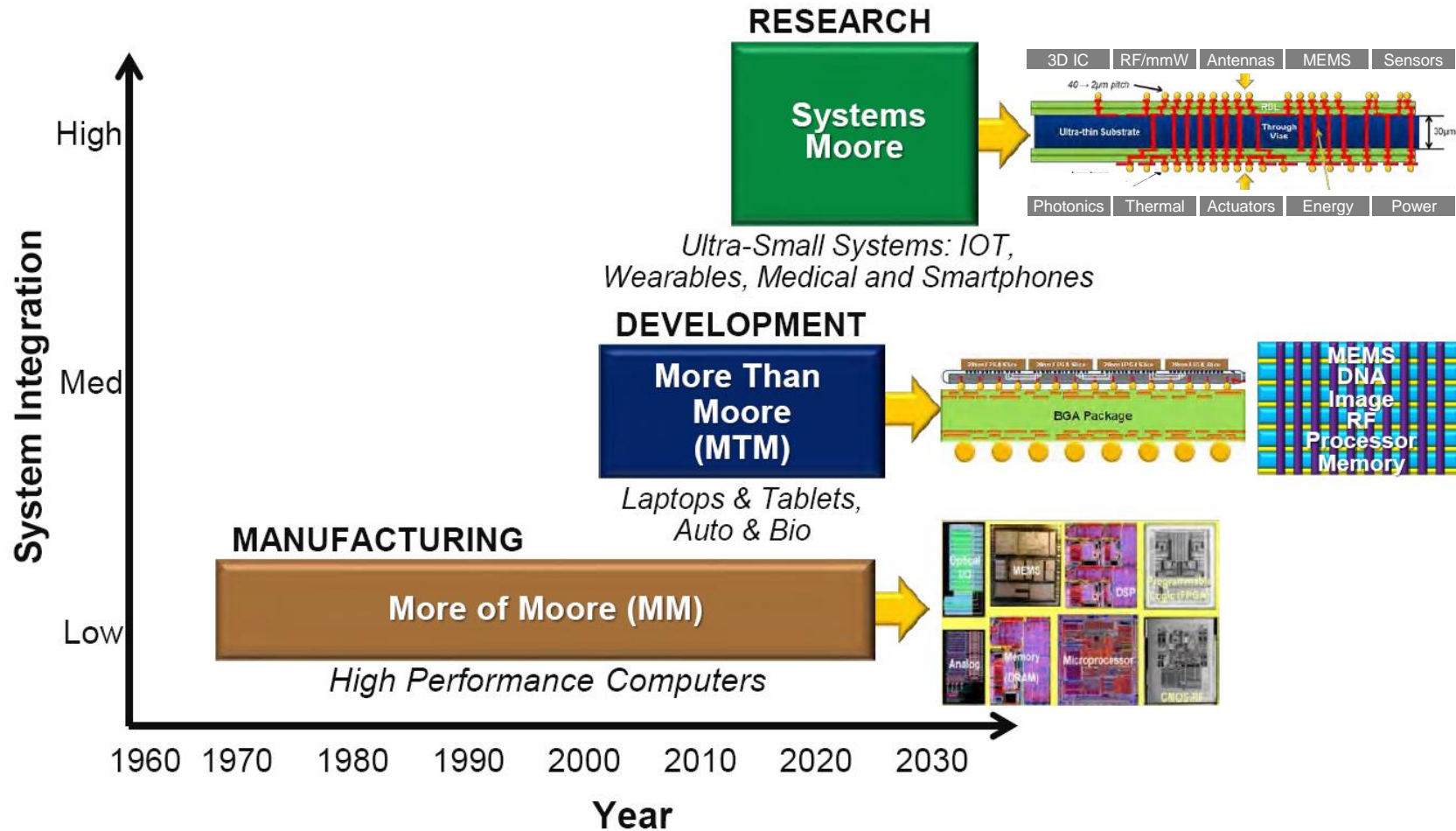

Objectives

- Fill the technology gap between sub- μm -sized devices and mm-sized system packages
- Support RF, mmW, Photonics technology developments for:
 - Augmented performance
 - New functionalities
 - Device/Circuit/System optimization

R. Tummala, System-On-Package (SOP) Mc Graw-Hill 2008

Femtosecond laser micromachining

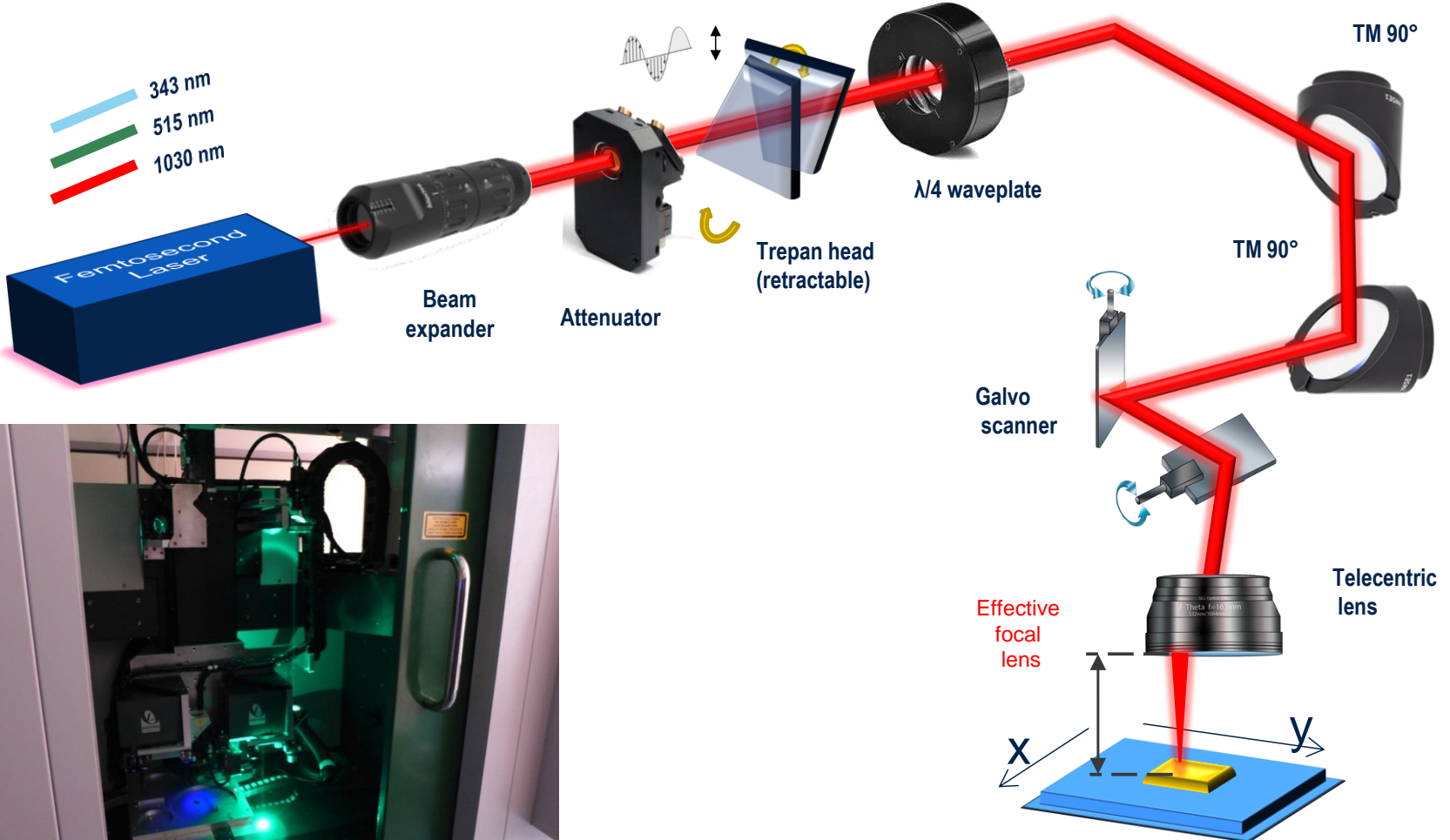
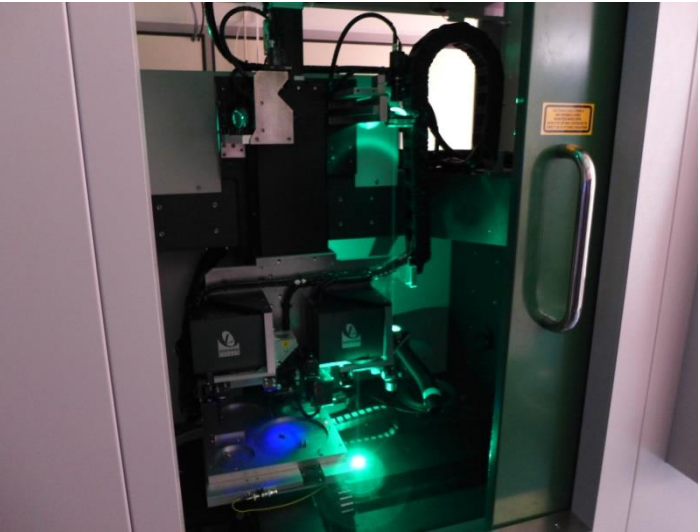
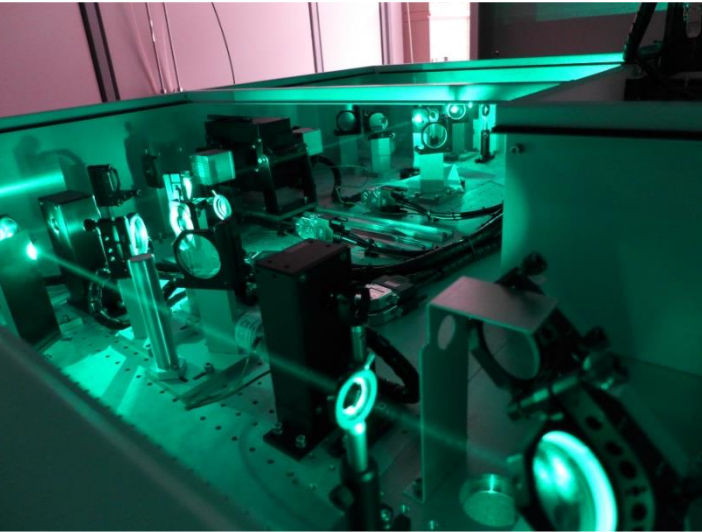
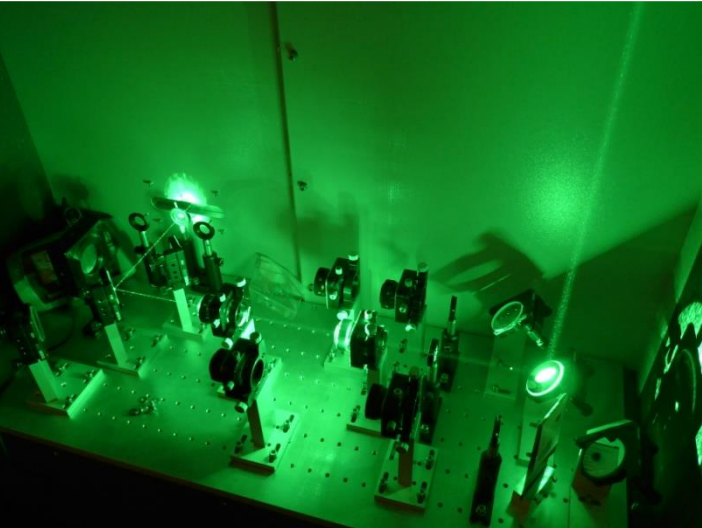

Advantages of femtosecond laser micromachining

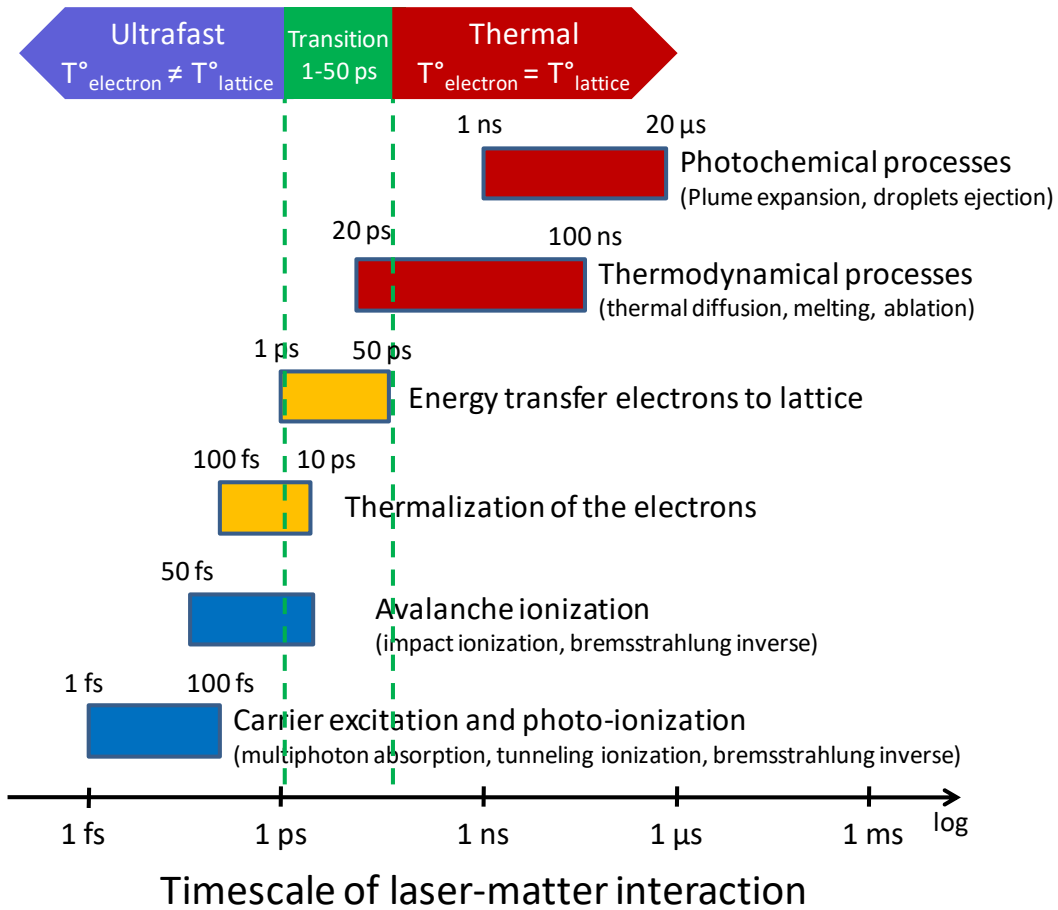

Courtesy : J. Lopez ALPHANOV CELIA UMR 5107

Multiphoton ionization

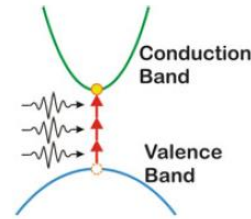

Tunneling ionization

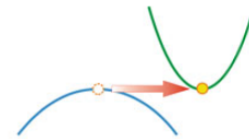

Avalanche ionization

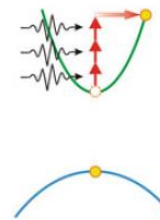

Impact ionization

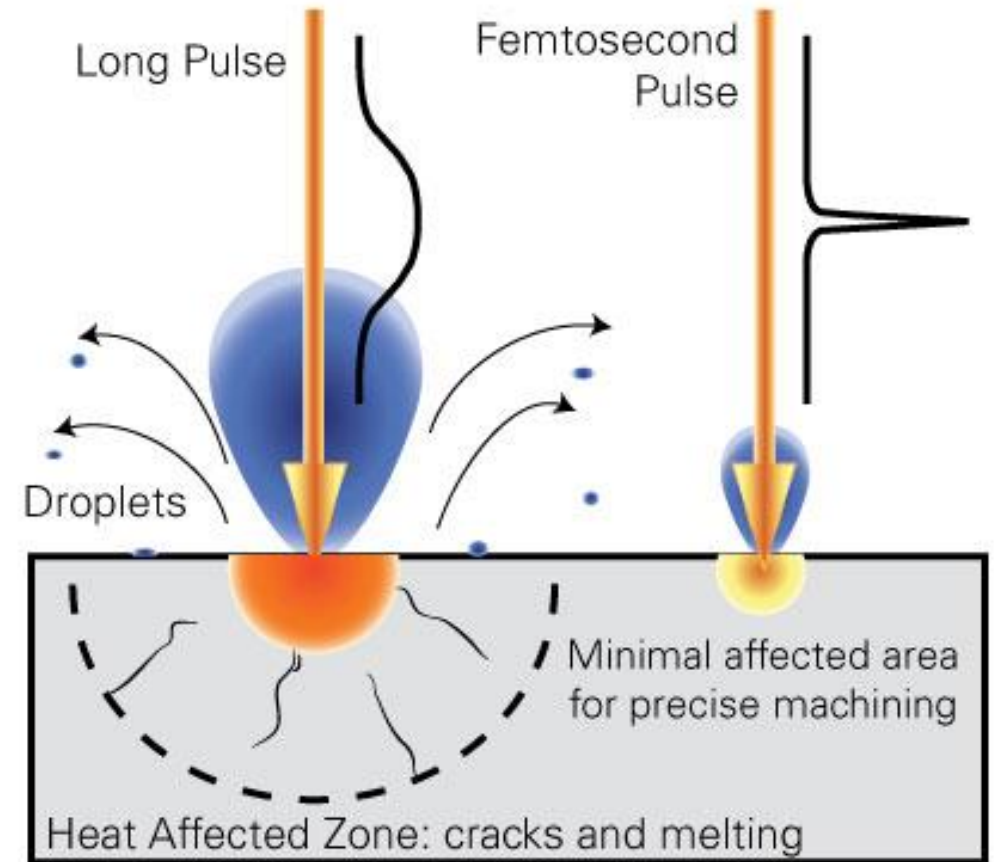

1 Functional Packaging: context and objectives

2 Electro-Optical Packaging for Silicon Photonics

3 Packaging for mmW and sub-THz electronics

4 Improved RF SOI-CMOS using laser substrate engineering

5 Perspectives - Summary & Roadmap

Electro-Optical Packaging for Silicon Photonics: motivation

- Silicon photonics
 - Low cost & derived from CMOS platform
 - Single mode communication
 - Addressing 100G standard through SDM
- Limitations
 - Active fiber alignment
 - Narrow optical I/O bandwidth

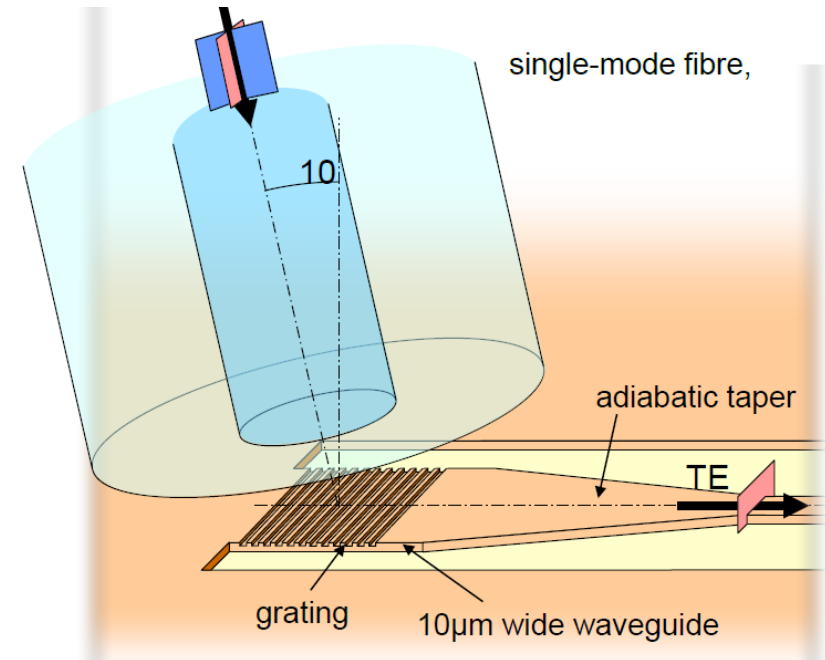
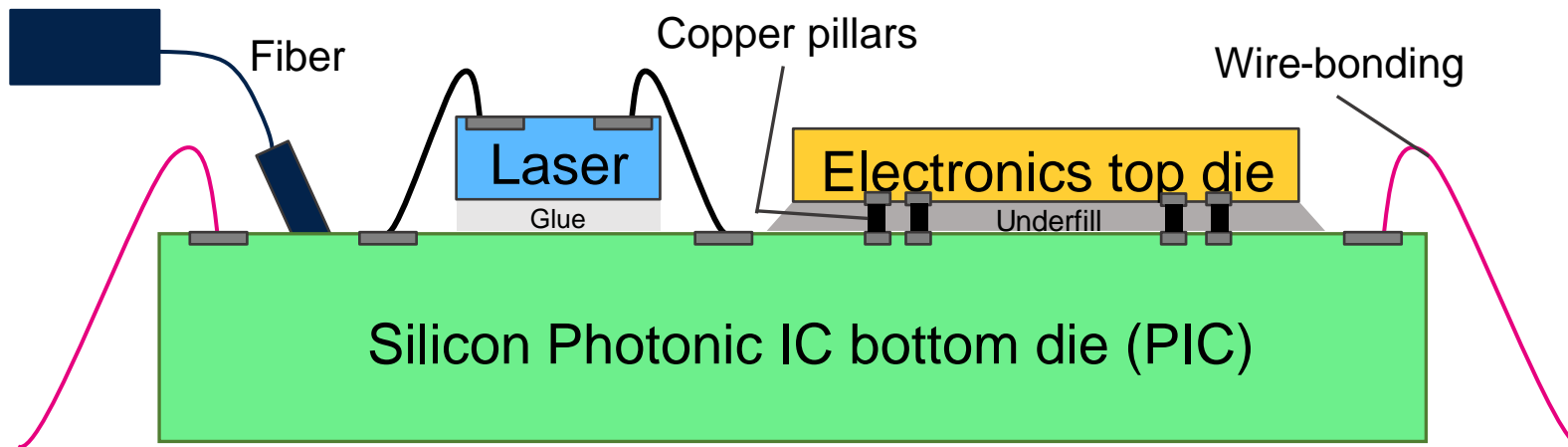
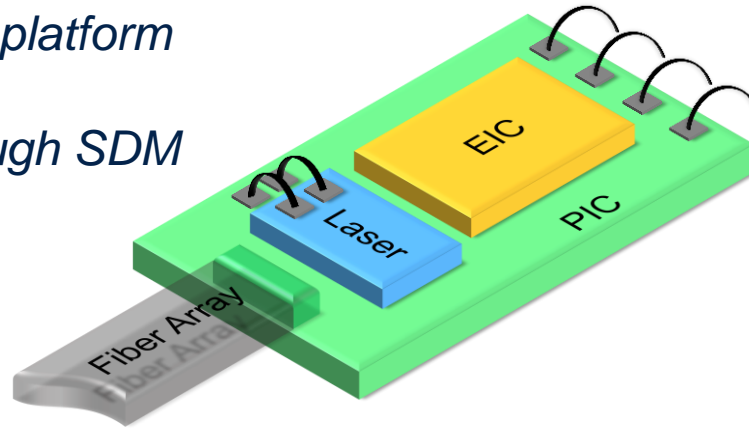

Source: *Coupling light to silicon photonic circuits*, Wim Bogaerts

Source : F. Boeuf *et al.*, IEEE IEDM, 2013

Electro-Optical Packaging for Silicon Photonics

Interposer Added-Value

- Passive alignment fiber butt-coupling
- CWDM Multiplexer on interposer
 - Potentially temperature insensitive
 - Enable wavelength specific grating couplers

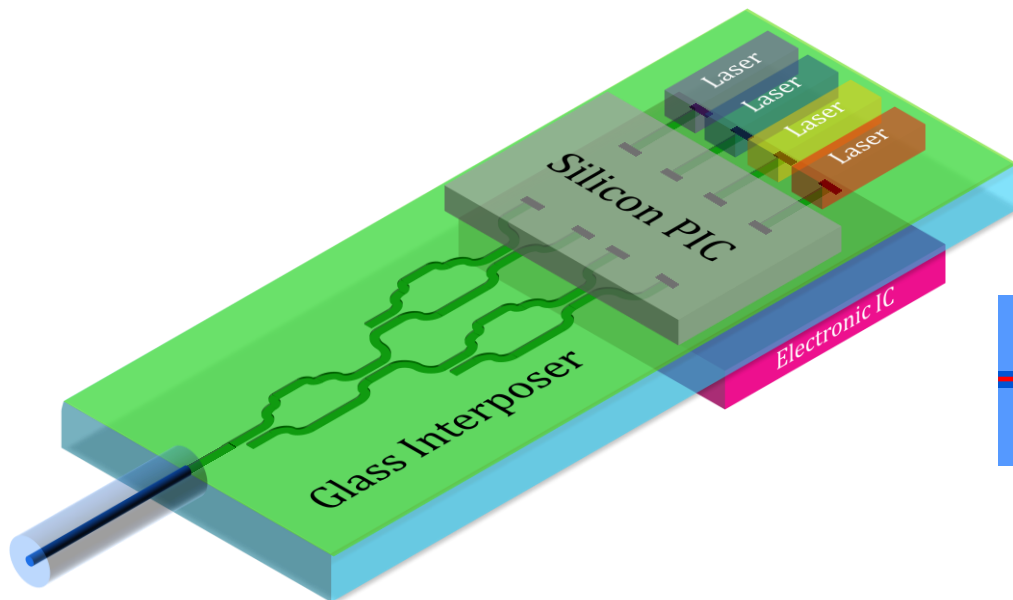

Objectives: packaging of silicon transceivers

- Single mode polymer waveguides
- RF transmission lines
- A slanted mirror for interposer/PIC coupling
- Demonstration of the optical coupling with a flip-chip bonded PIC25G IC

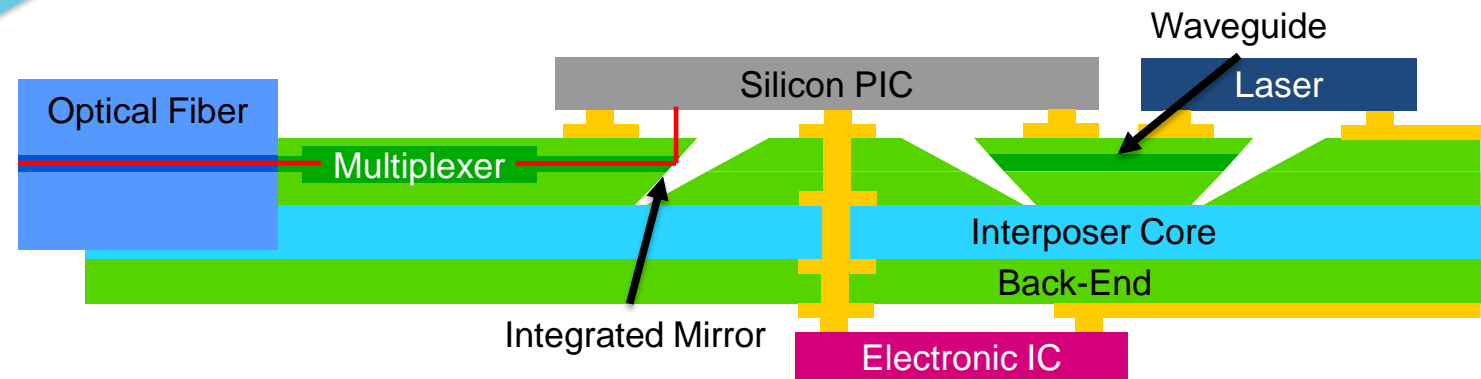

EO Packaging for Si Photonics: technological blocks

RF/mmW transmission lines

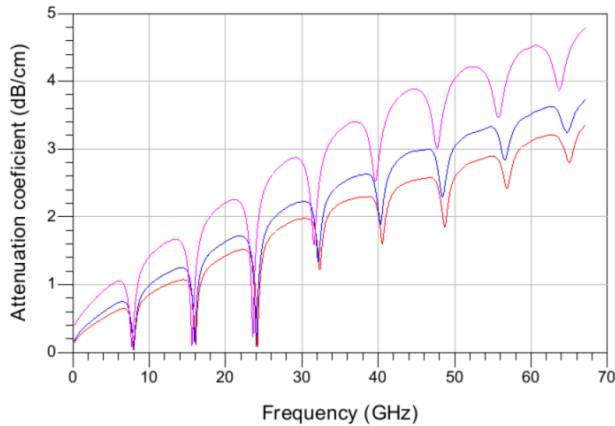
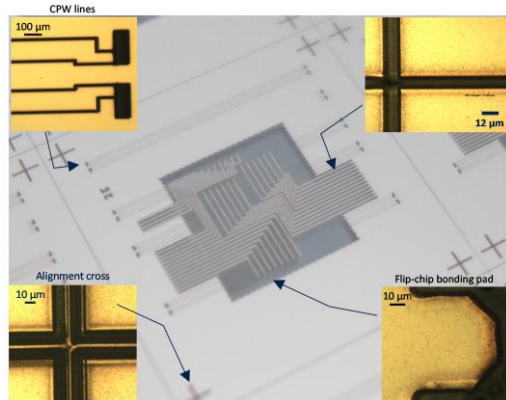

Polymer optical rib waveguides

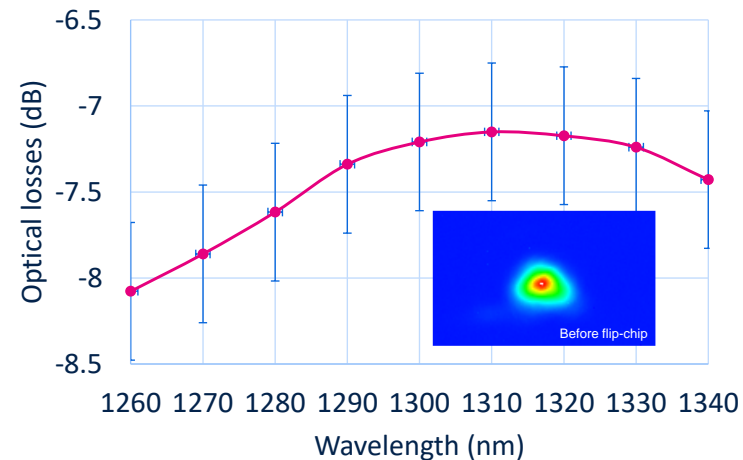
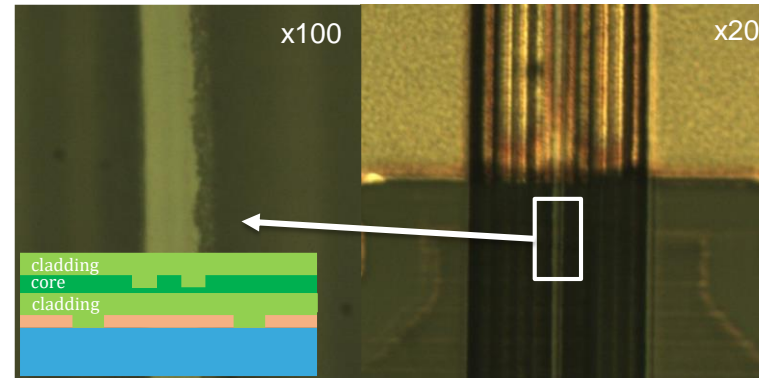

<1 dB variation over CWDM band
 Propagation losses: $4.4 \pm 0.25 \text{ dB.cm}^{-1}$

RF/mmW transmission lines

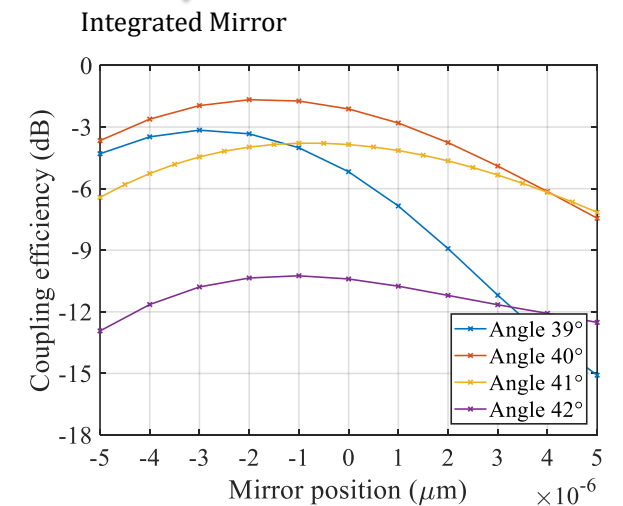
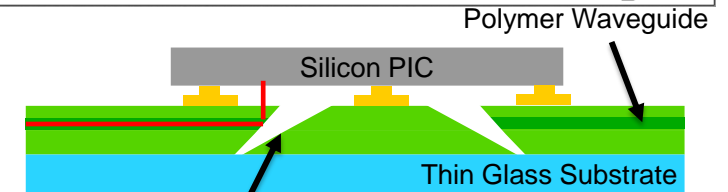
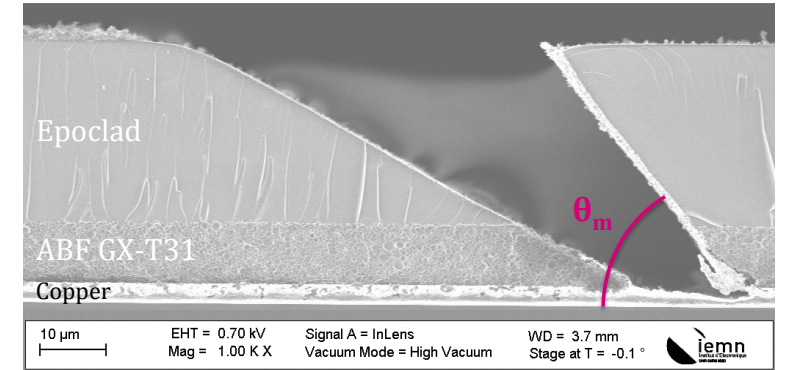

EO Packaging : Assembly and characterization

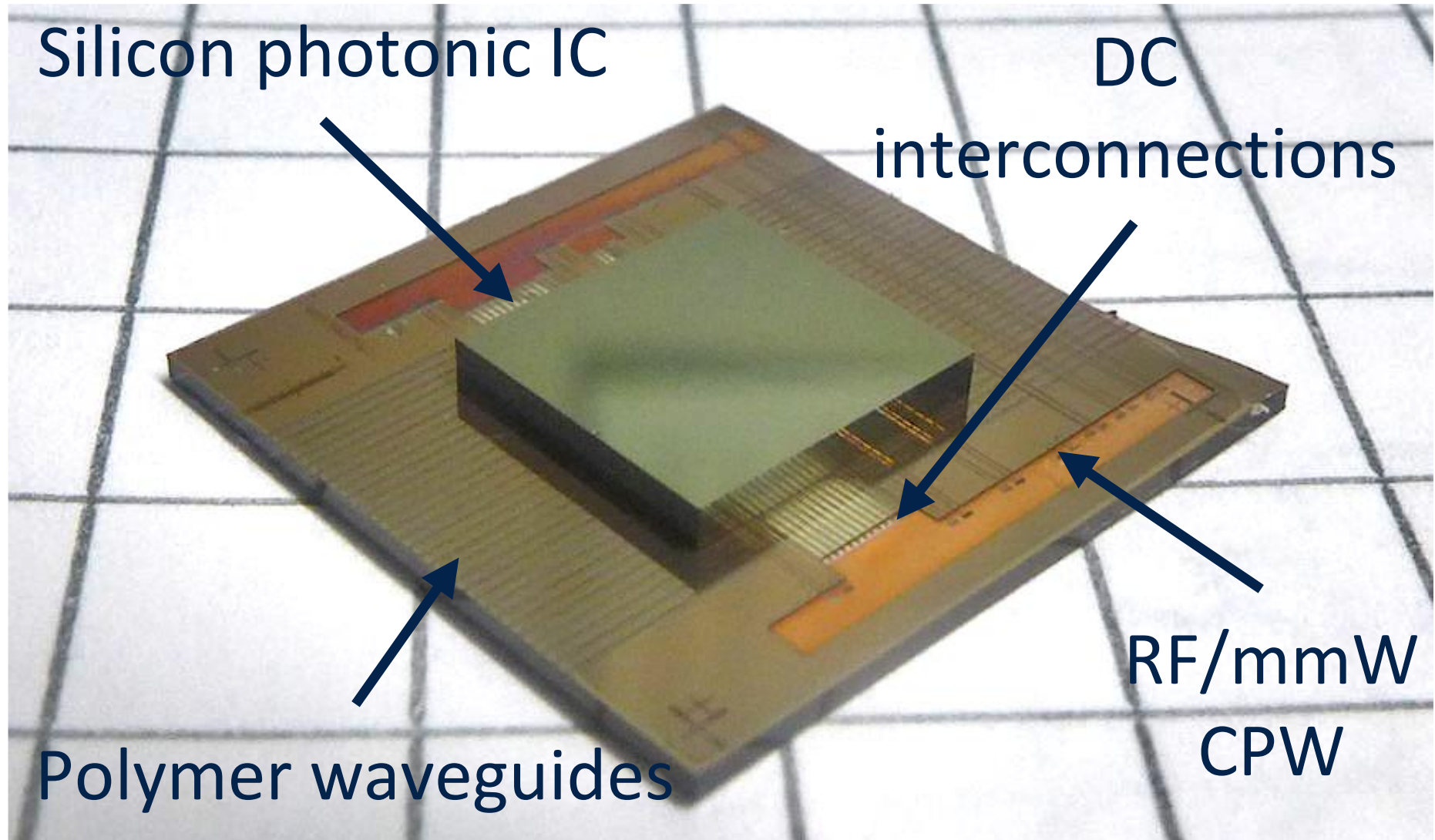

EO Packaging : Assembly and characterization

Flip-chip assembly

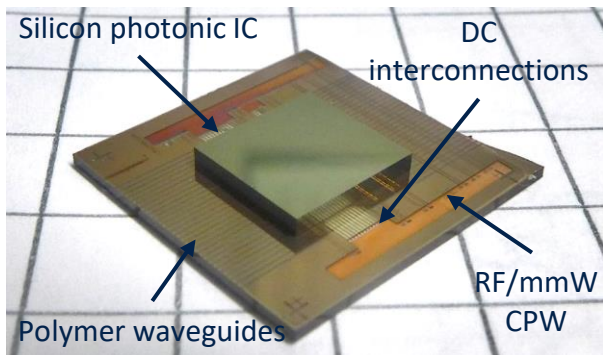

RF/mmW routing

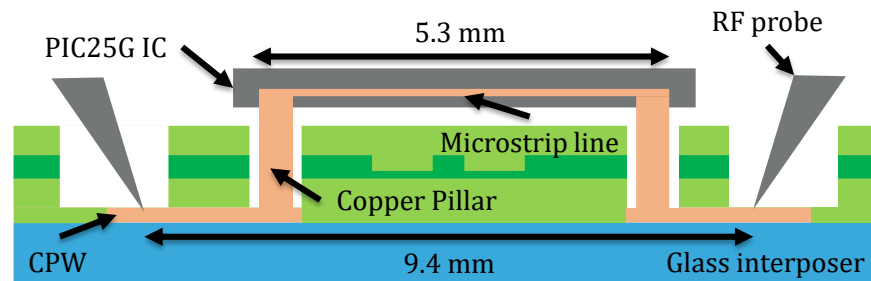

Optical-Electrical conversion

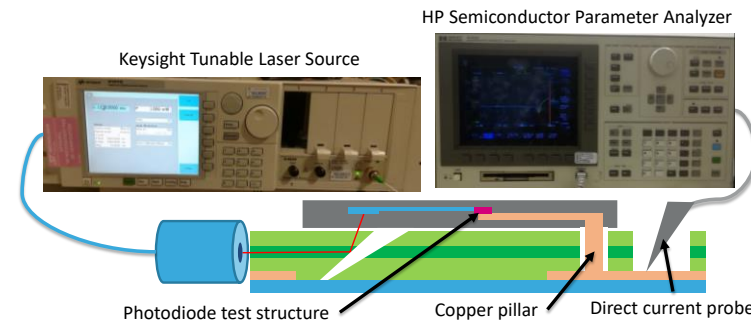

Optical routing

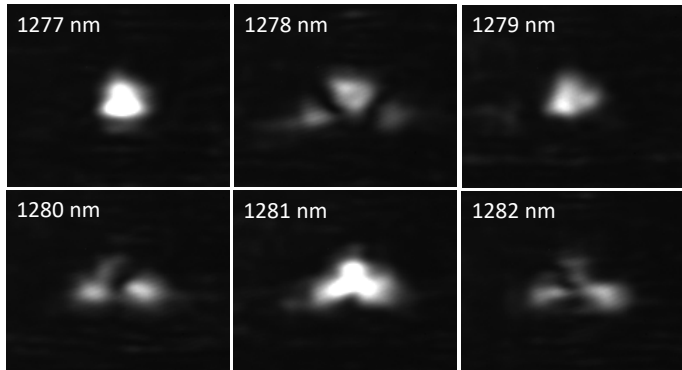
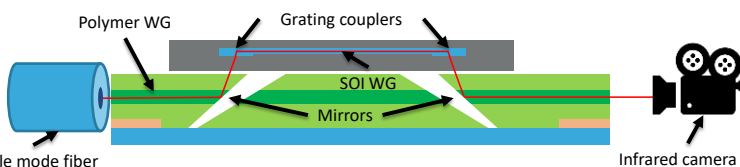

Losses due to mirror & wavelength dependence

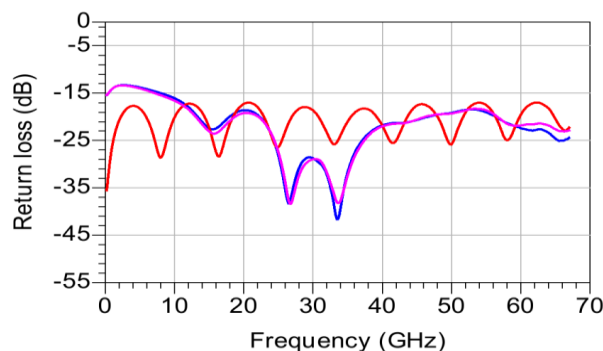
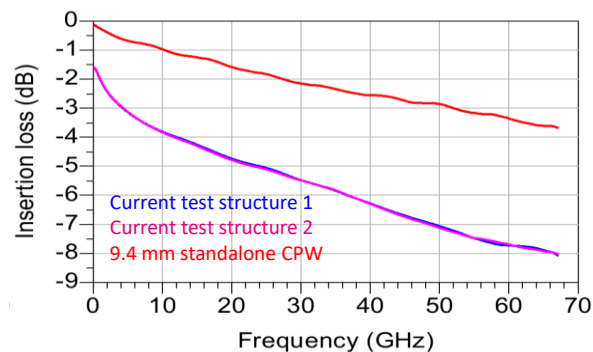

High frequency coupling validated
No significant impact on loss

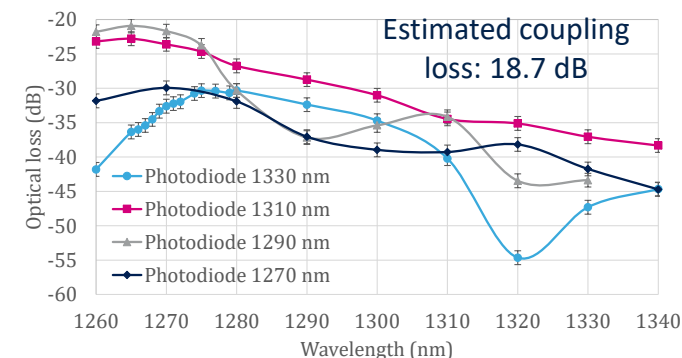
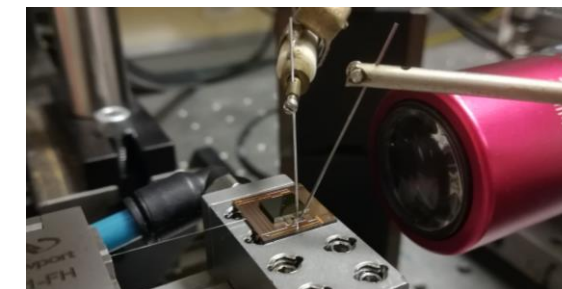

1

Functional Packaging: context and objectives

2

Electro-Optical Packaging for Silicon Photonics

3

Packaging for mmW and sub-THz electronics

4

Improved RF SOI-CMOS using laser substrate engineering

5

Perspectives - Summary & Roadmap

Packaging for mmW and THz electronics: motivation

Microfabrication Objectives

- Need to couple tiny Silicon chips to rectangular waveguides in mmW frequency range
- mmW waveguides fall in the gap between advanced CNC machining and clean room microfabrication
- Use laser micro-machining for low cost and compact planar waveguide architecture

Freq. (GHz)	Band / WG Standard	Dimensions (μm^2)
140-220	G / WR-5	1295x648
220-325	J / WR-3	864x432
325-500	Y / WR-2	508x254
500-750	Y / WR-1.5	381x190
750-1100	Y / WR-1	254x127

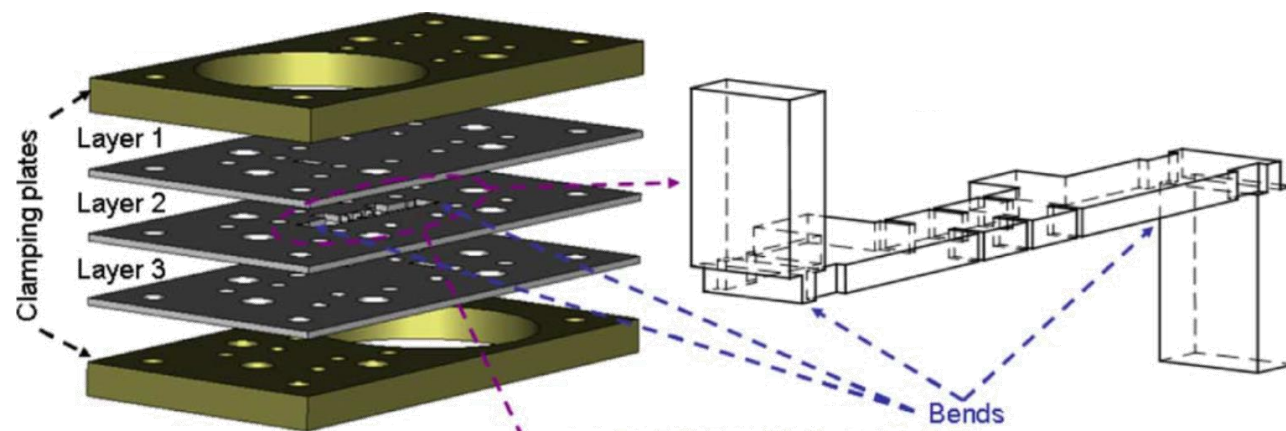
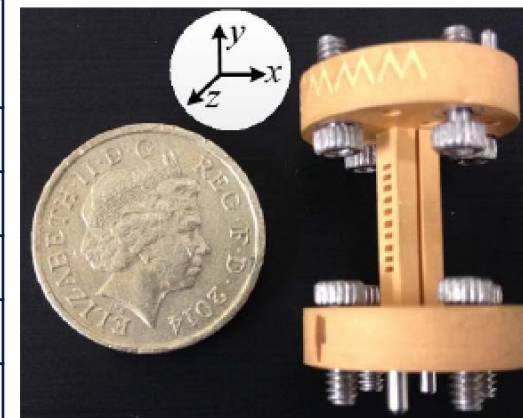

Packaging for mmW and THz electronics

Al₂O₃ Straight Waveguide

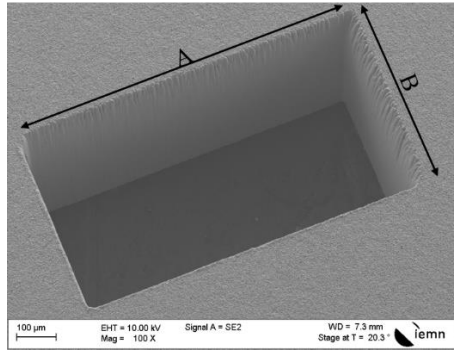
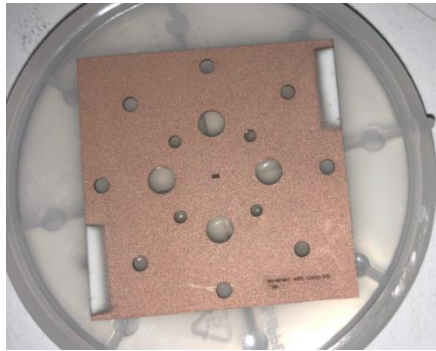

J-Band Tile-Style Planar Waveguide

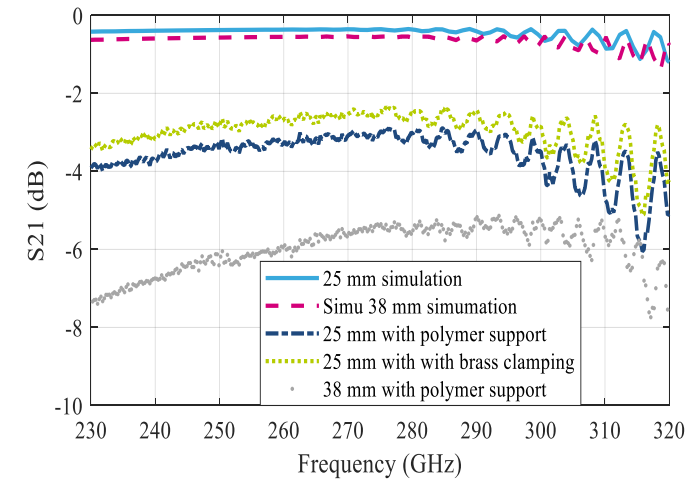
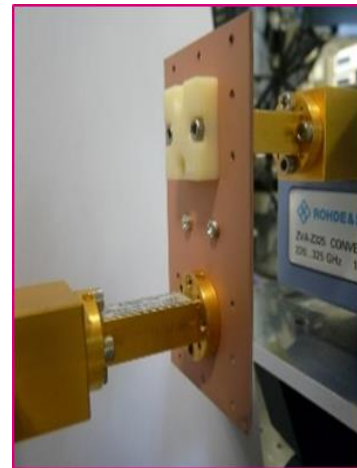
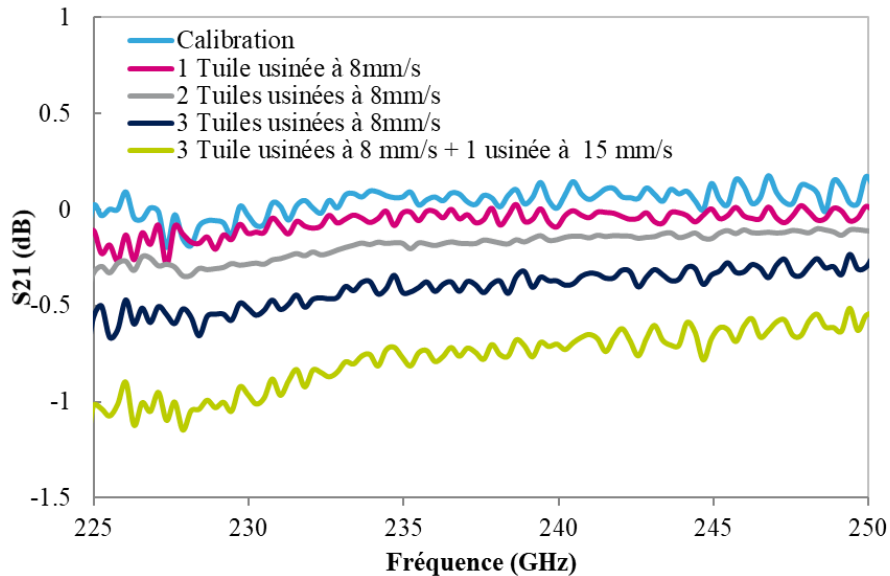
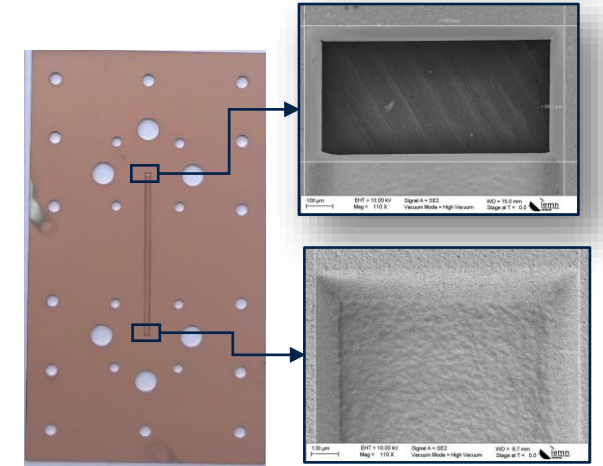
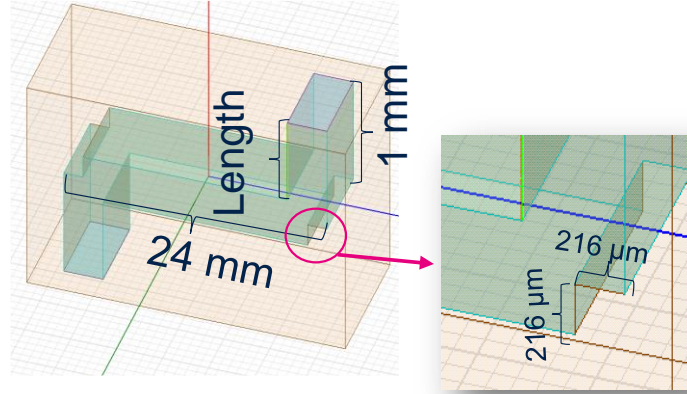

Packaging for mmW and THz electronics

New material exploration: PMMA

G-band (140-220 GHz) measurements

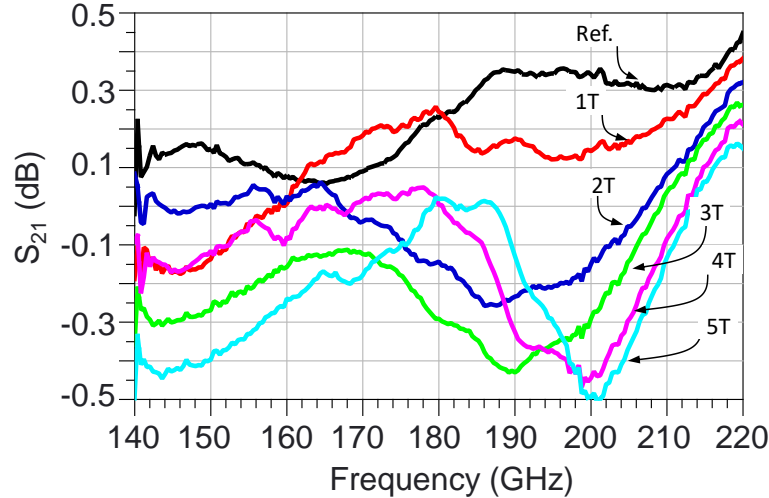
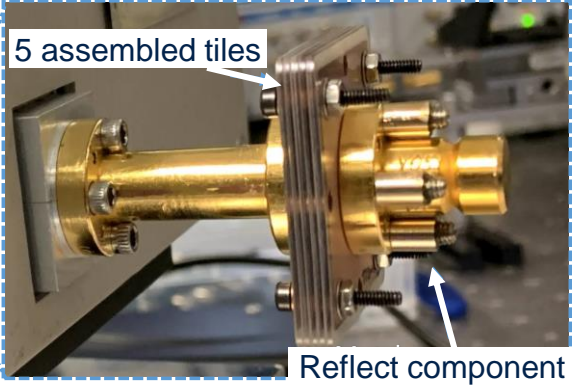
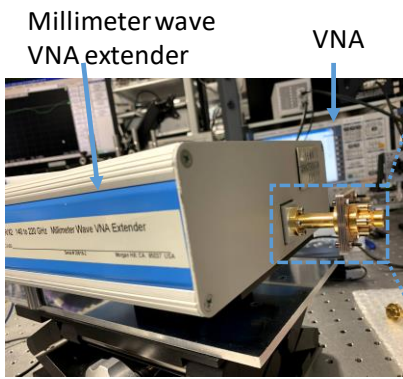
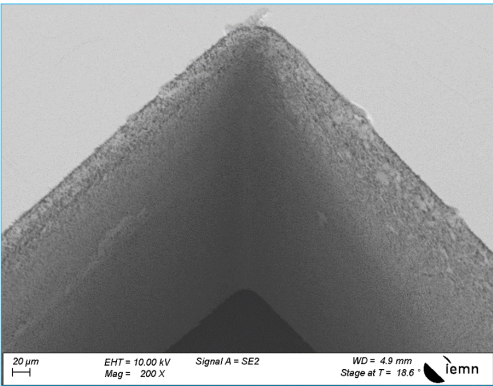
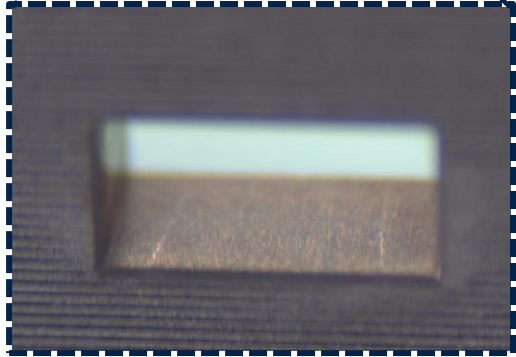
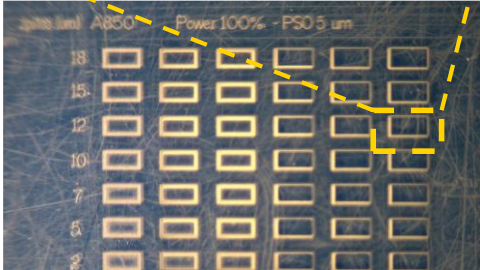
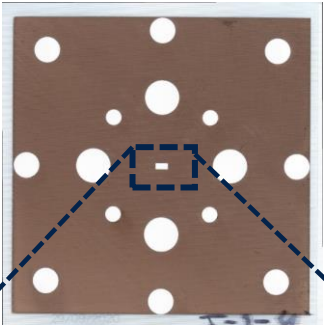
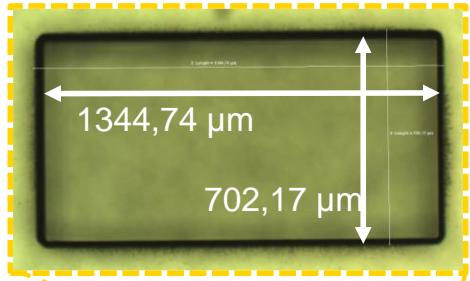

1

Functional Packaging: context and objectives

2

Electro-Optical Packaging for Silicon Photonics

3

Packaging for mmW and sub-THz electronics

4

Improved RF SOI-CMOS using laser substrate engineering

5

Perspectives - Summary & Roadmap

Improved RF SOI-CMOS using substrate engineering

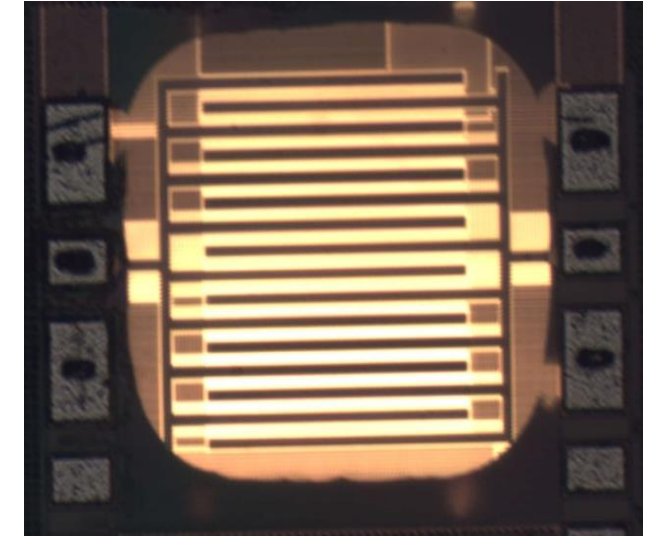
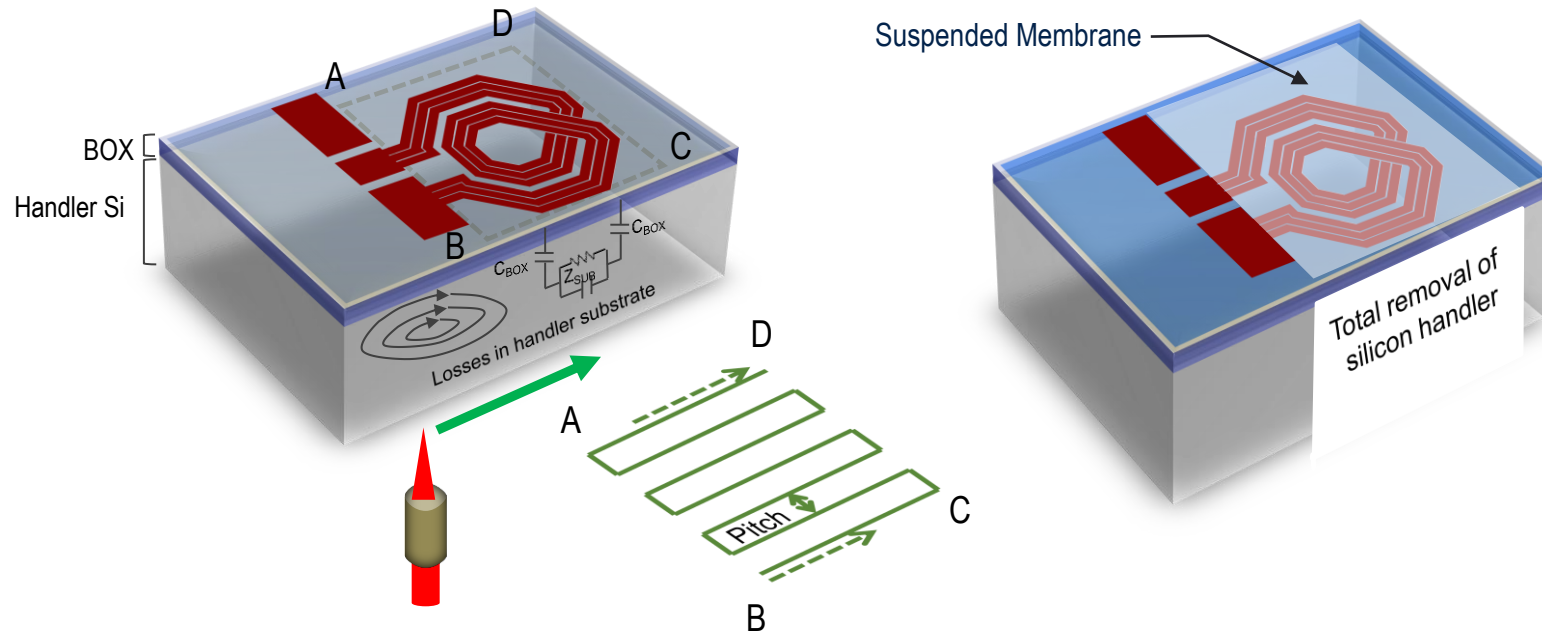

Laser Processing Results

- Efficiency of the silicon laser ablation process
- Study of scribing of trenches for optimal choice of process parameters
- Extrapolation to surface milled cavities
- Fabrication of ultimate membranes on SOI

RF Performance Results

- Study of RF losses (small signal) and linearity (large signal) of SP9T switch
- Study of Q-factor of inductors with compact modelling
- Noise figure study of inductor membranes used in LNA circuits

Laser ablation of silicon in infrared

Trench Analysis

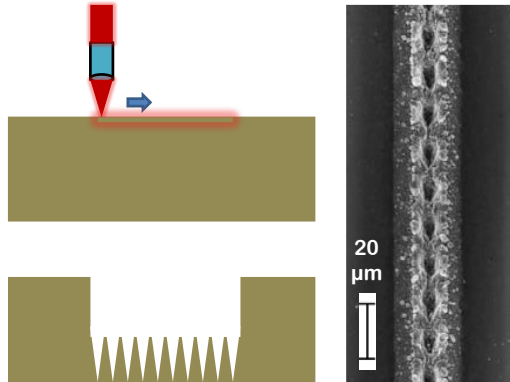

30 kHz

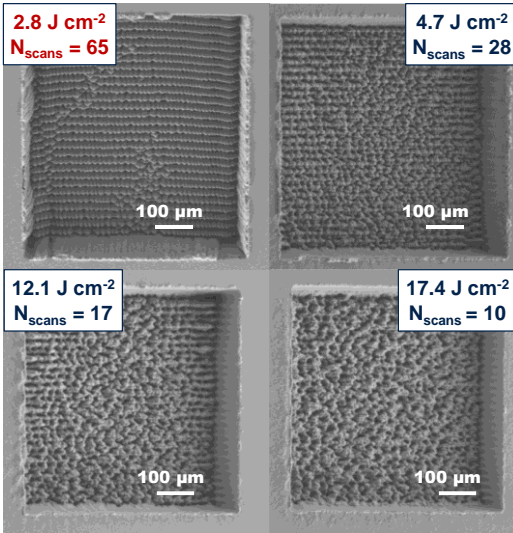

Surface milling optimization

200 kHz

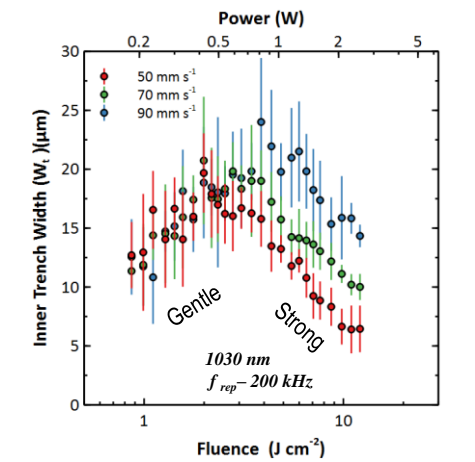
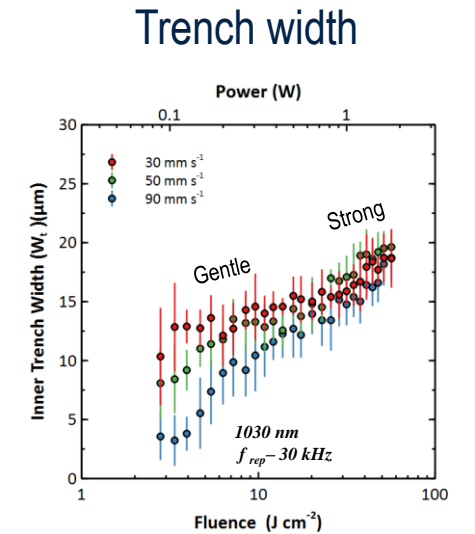
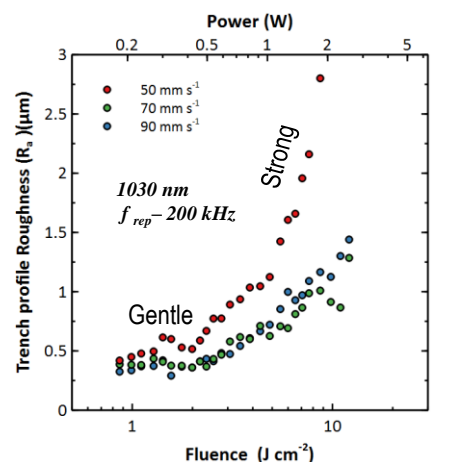
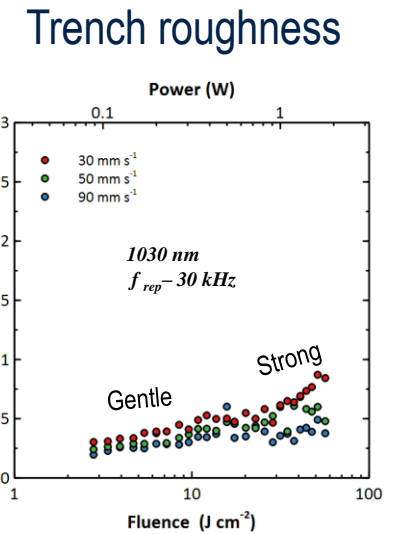
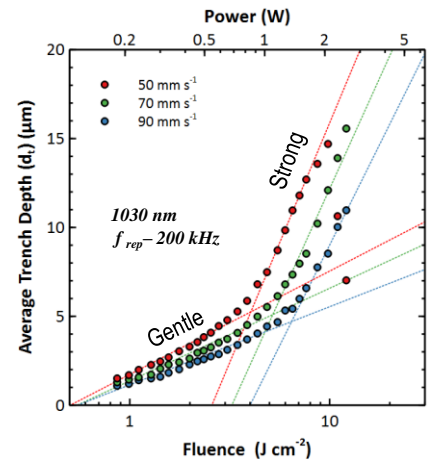
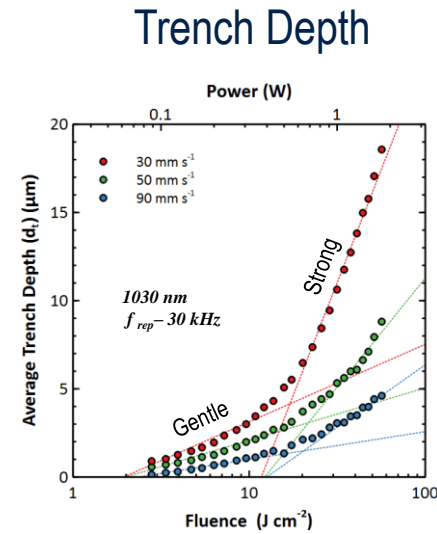

The removal rate can be as high as 20 μm per pass and up to $7 \times 10^6 \mu\text{m}^3 \text{s}^{-1}$

FLAME Process

(Femtosecond Laser Assisted Micromachining and etching)

Application of the FLAME process

Femtosecond Laser Assisted Micromachining and Etch

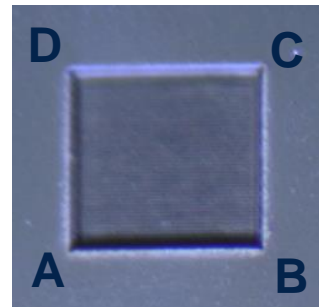
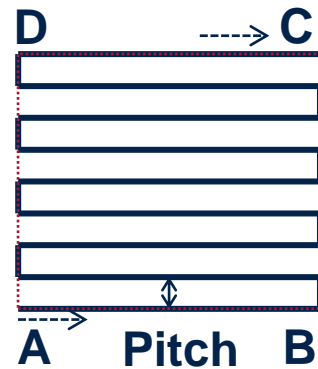
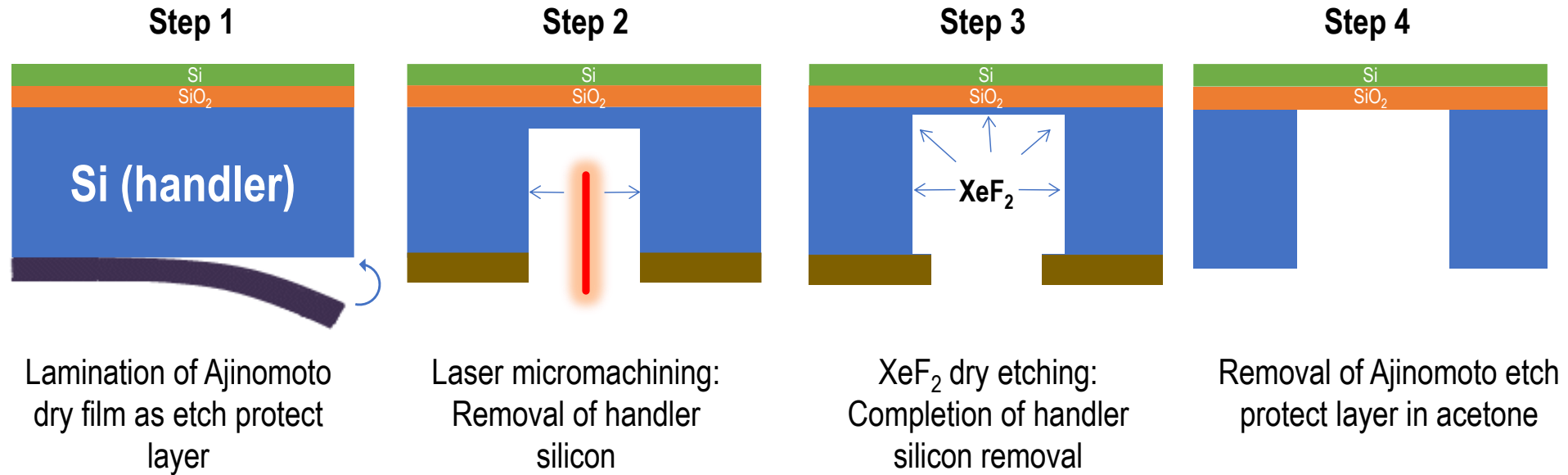

$\text{Area}_{ABCD} \approx \text{Active area of RF component}$

Application of the FLAME process

Femtosecond Laser Assisted Micromachining and Etch

Milled cavity

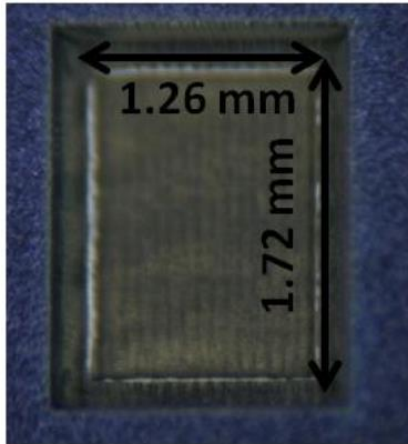

25 cycles

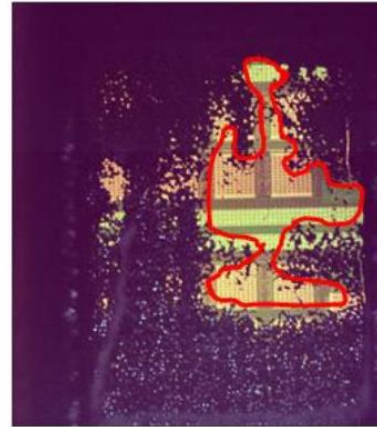

75 cycles

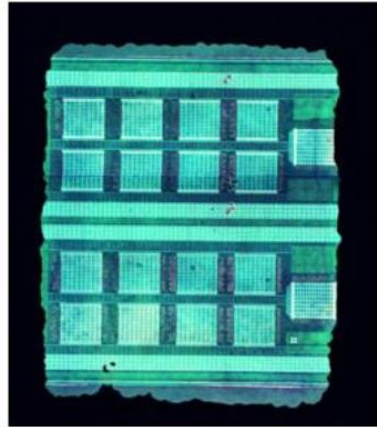

XeF₂ etching



- Selective isotropic etchant of Si over SiO₂ (selectivity of 1000:1)
- Etch parameters (with typical values used)
 - Cycle time: 10 s
 - XeF₂ pressure: 2 Torr
 - Temperature: 40 °C
 - No. of cycles: 30 - 100

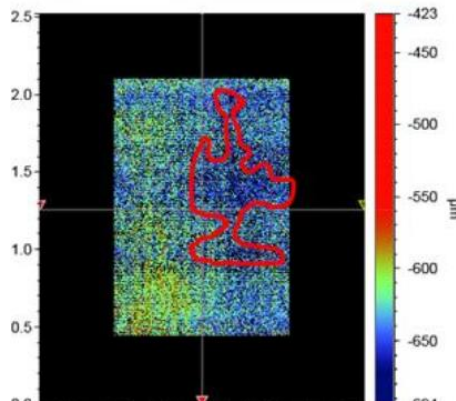

Depth profile

50 cycles

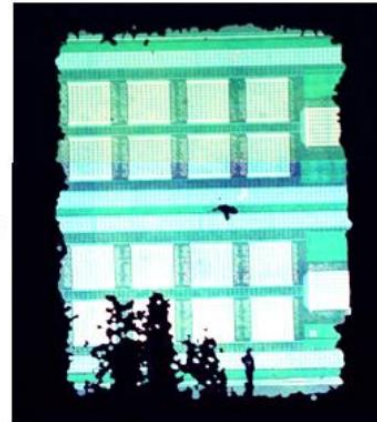

100 cycles

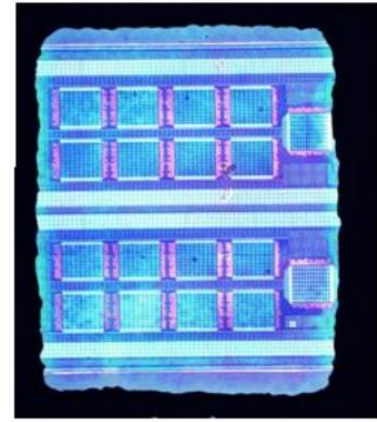

Flame Application to RF switch

Typical switch architecture

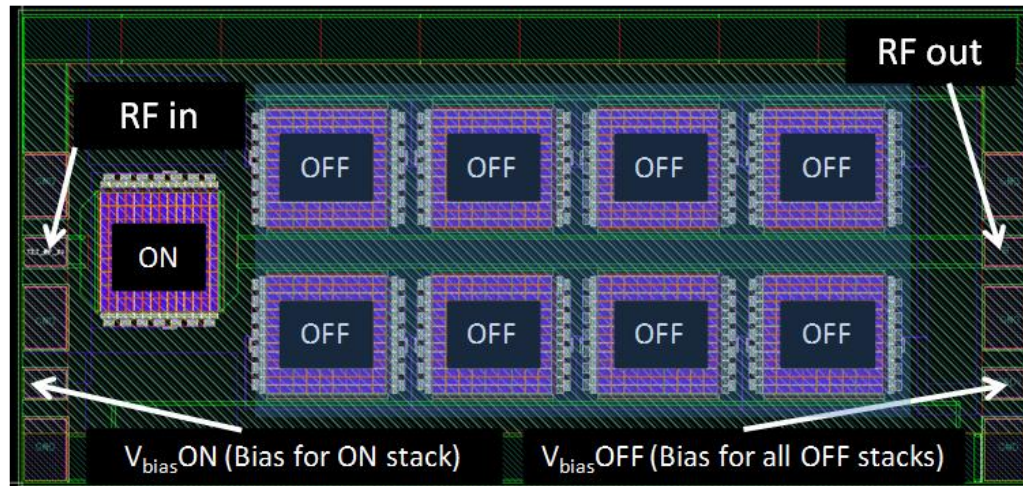
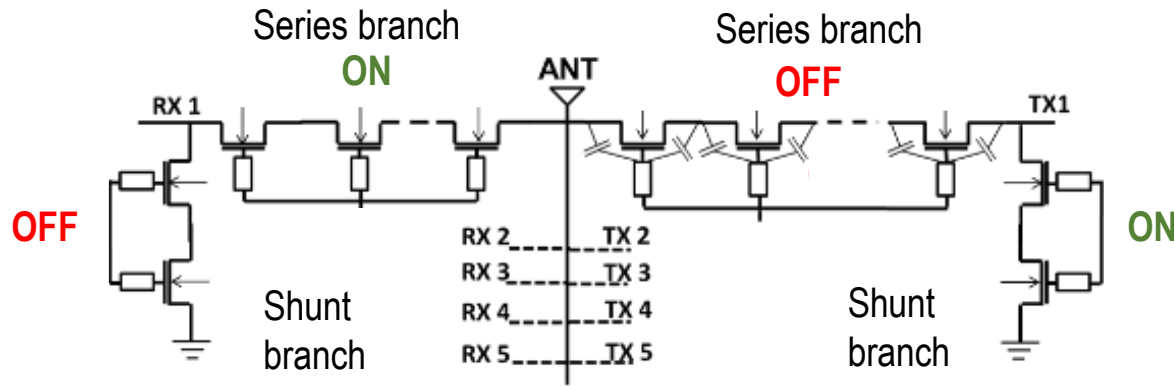

SP9T switch test structure

RF-specific SOI substrates

High-resistivity (HR)

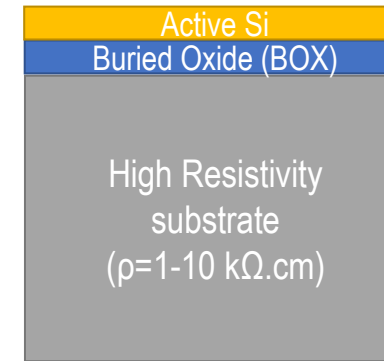

Trap-rich (TR)

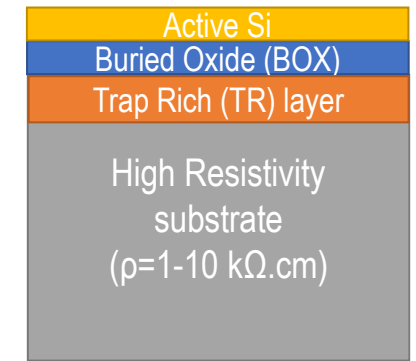

TR-SOI vs HR-SOI performance

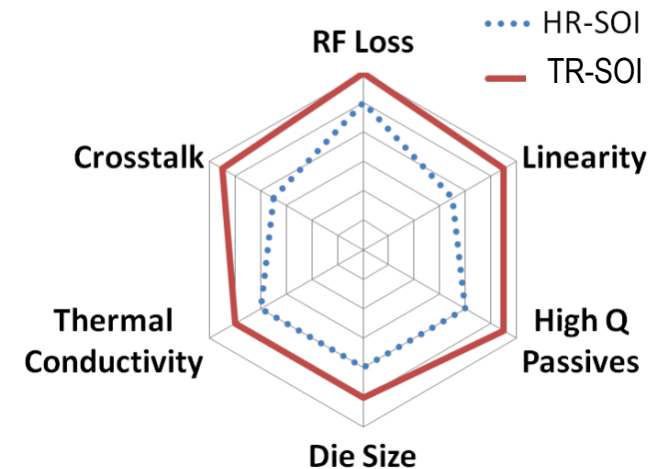

Improved RF SOI-CMOS switch: insertion losses

SP9T switch

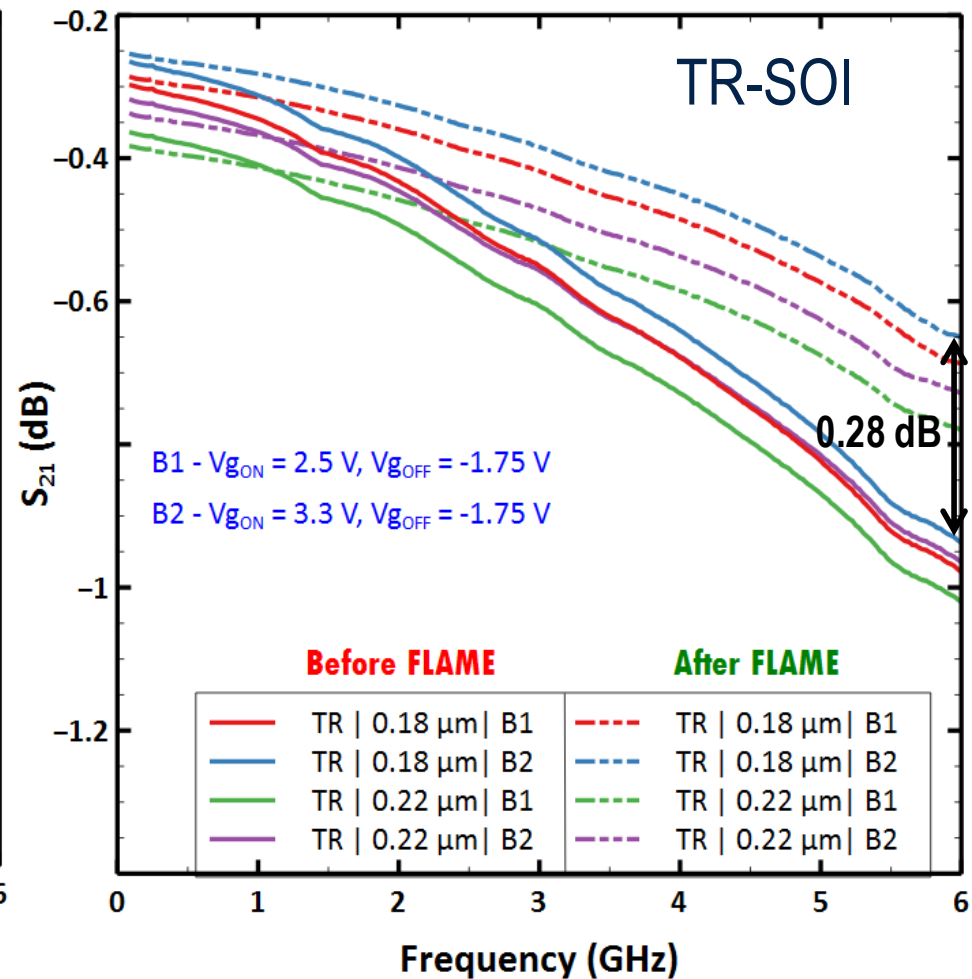
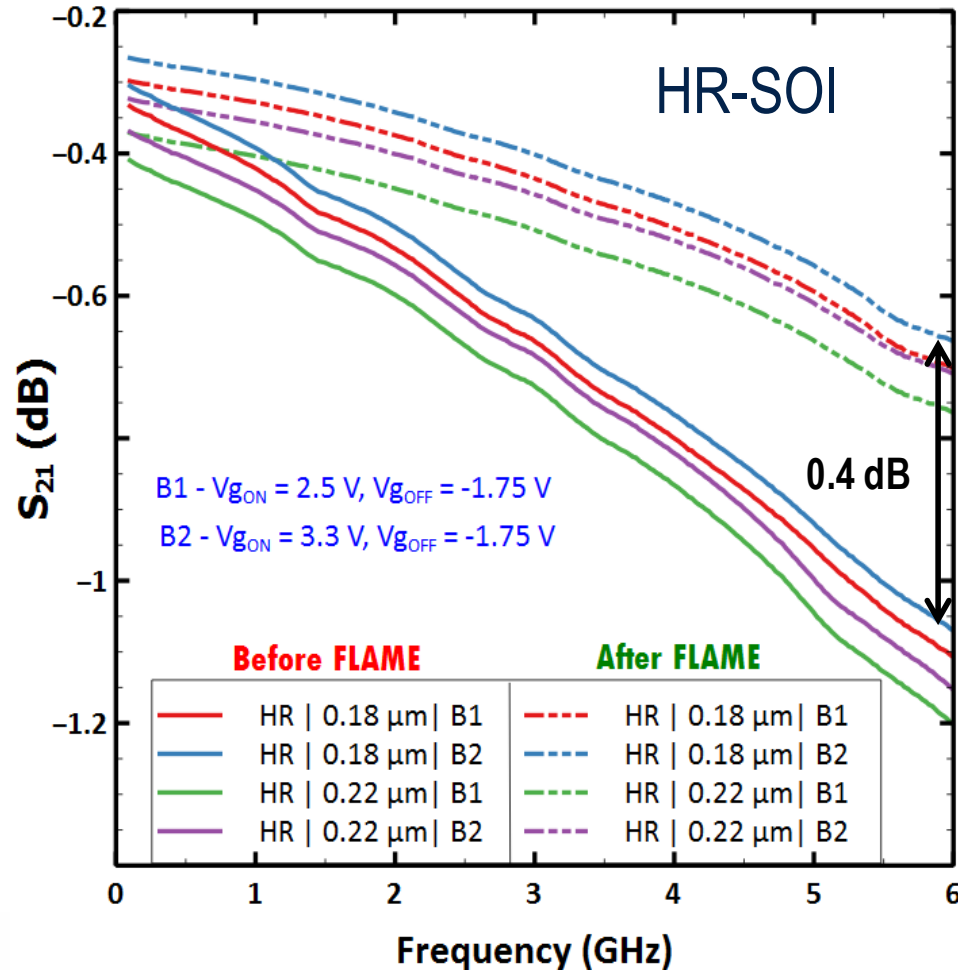

Improved RF SOI-CMOS switch : return losses

SP9T switch

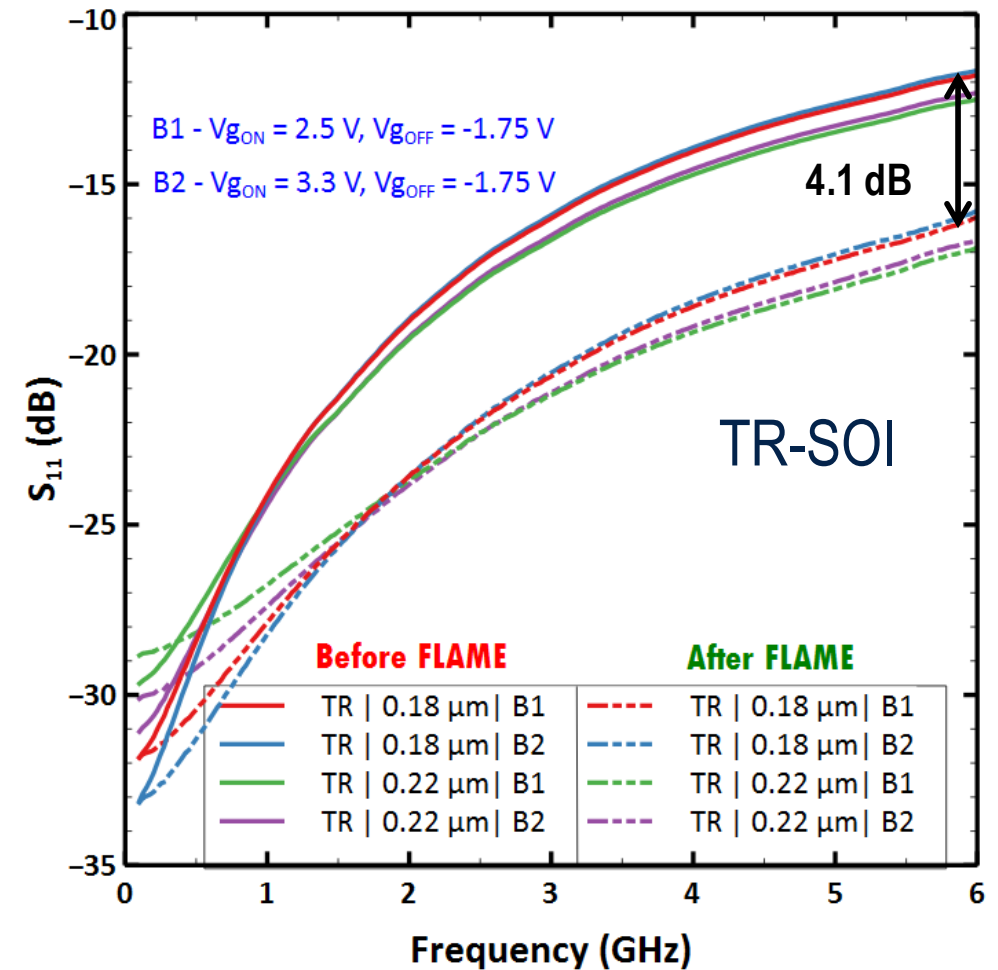
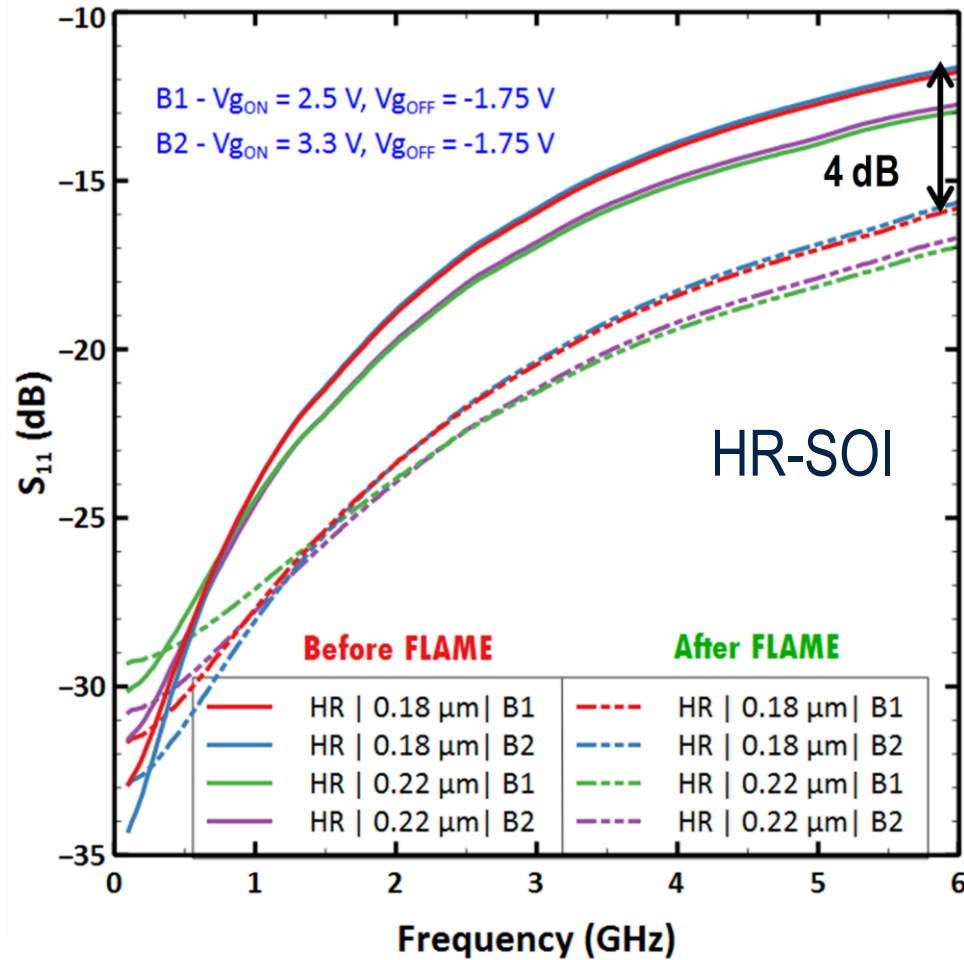

Improved RF SOI-CMOS: large signal harmonic distortion

SP9T switch at fundamental $f=1\text{GHz}$

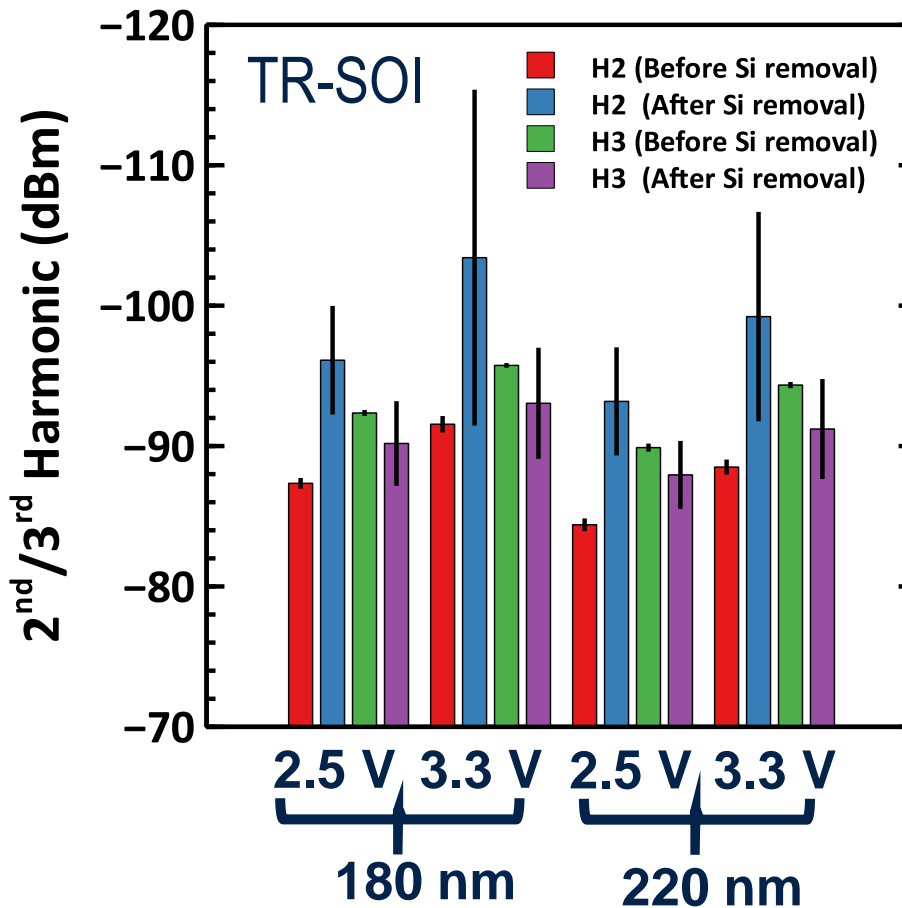
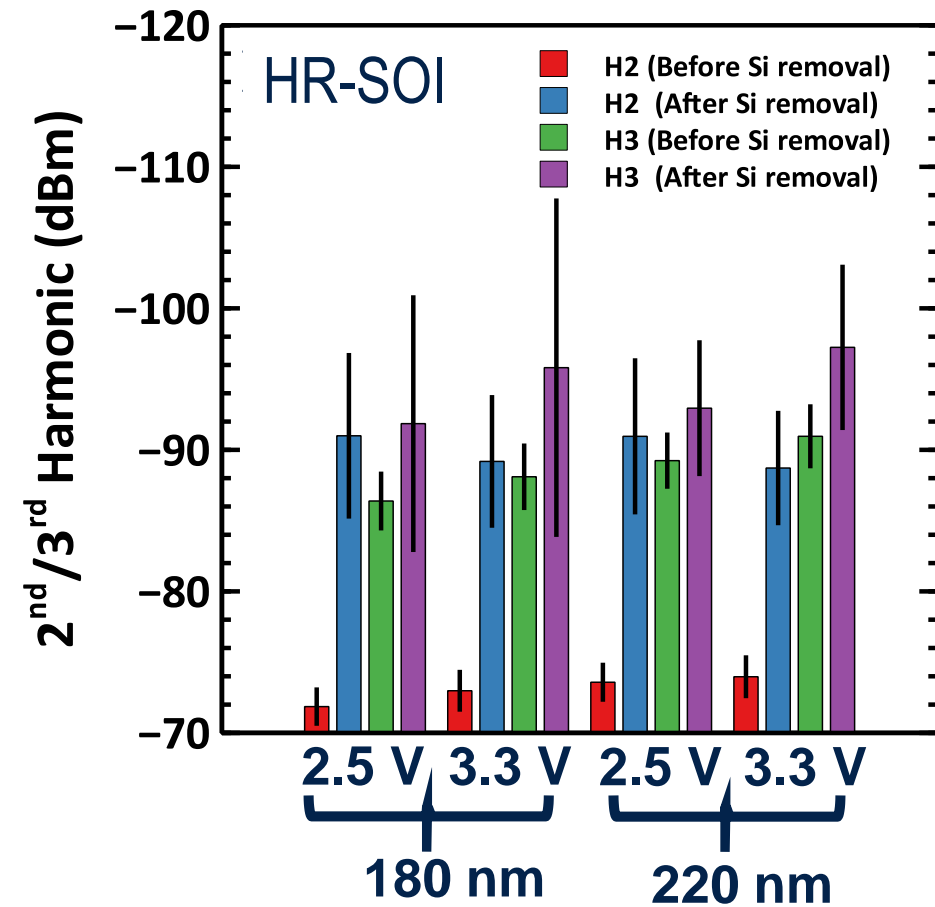

$L_g = 180\text{ nm}$

HR-SOI substrate

- H2 reduces by 22.7 dB
- H3 reduces by 5.6 dB

TR-SOI substrate

- H2 reduces by 7.8 dB
- H3 does not change

Improved RF SOI-CMOS: inductance Q-factor

Q-factor improvement

$$Q_{SR}/Q_{TR} = 1.5$$

$$Q_{SR}/Q_{HR} = 1.8$$

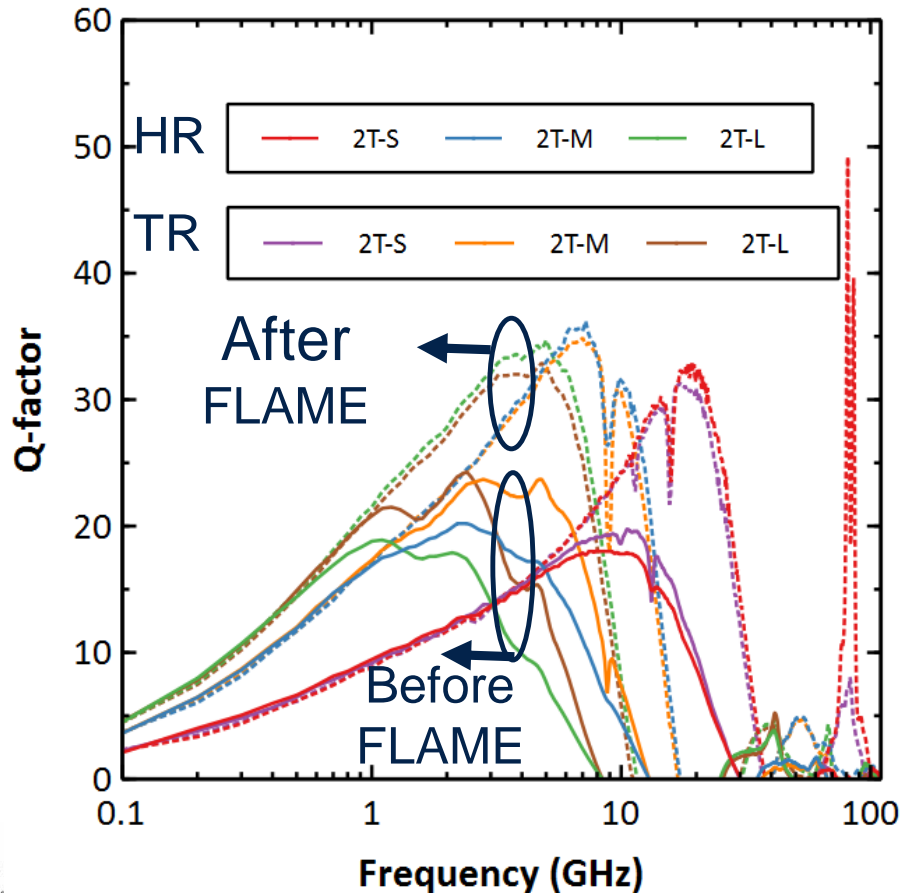
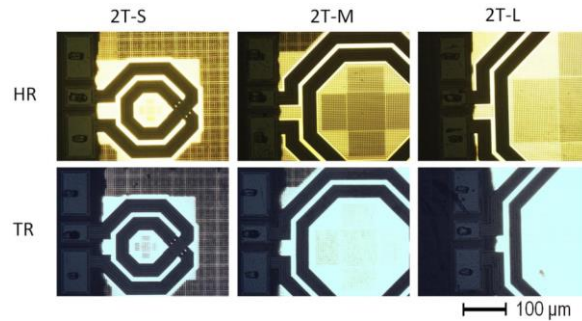

Low Noise Amplifier
Noise Figure improvement

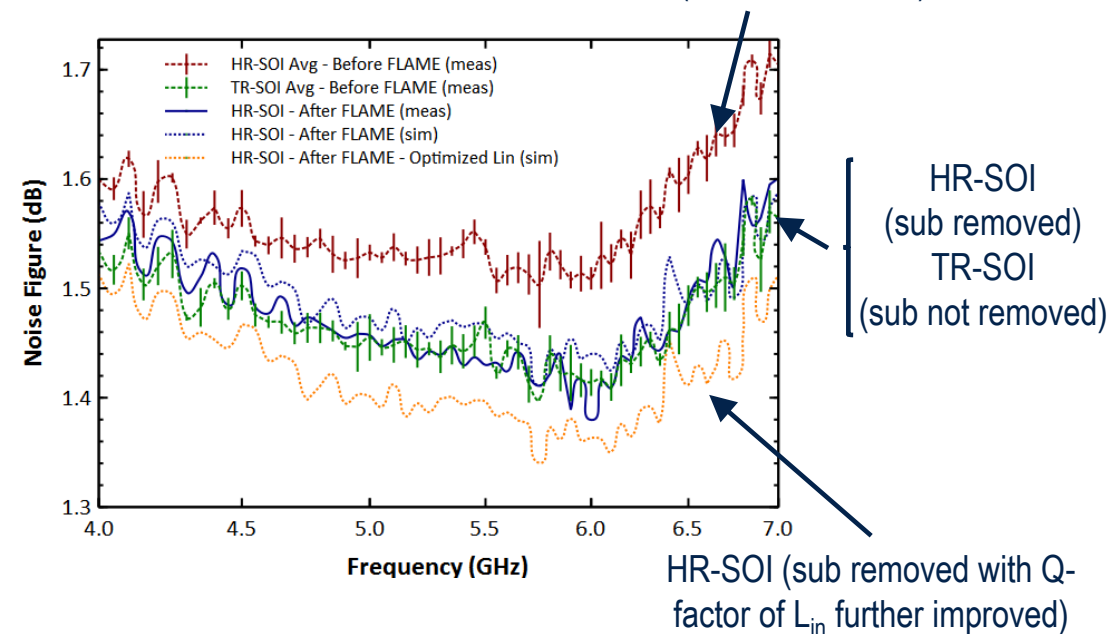
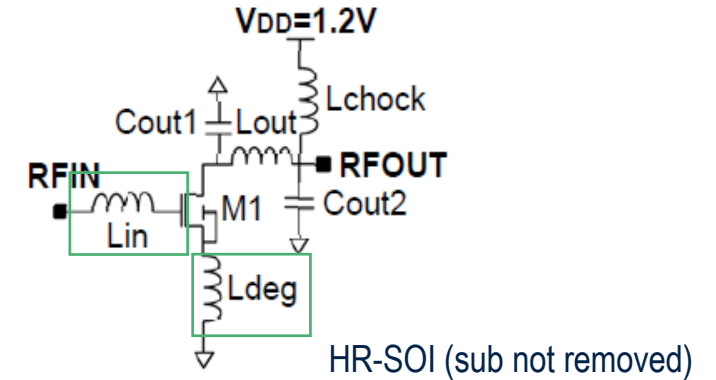

Summary

- Laser micromachining fully addresses the 1 μ m-1mm packaging range
- Functional Packaging fully takes advantages of laser techniques
 - Electro-optical interposer for Si-photonics applications
 - Optimal tool for microstructuring waveguides in the mmW and sub-THz bands
 - Substrate engineering to investigate ultimate performance of RF/mmW/photonics devices/circuits/systems

