



HAL
open science

Integrating process design and control: An application of optimal control to chemical processes

M. Miranda, Jean-Michel Reneaume, Xuân-Mi Meyer, Michel Meyer, F. Szigeti

► **To cite this version:**

M. Miranda, Jean-Michel Reneaume, Xuân-Mi Meyer, Michel Meyer, F. Szigeti. Integrating process design and control: An application of optimal control to chemical processes. *Chemical Engineering and Processing: Process Intensification*, 2008, 4 (11), pp.2004-2018. <10.1016/j.cep.2007.11.010>. <hal-03579890>

HAL Id: hal-03579890

<https://hal.science/hal-03579890v1>

Submitted on 18 Feb 2022

HAL is a multi-disciplinary open access archive for the deposit and dissemination of scientific research documents, whether they are published or not. The documents may come from teaching and research institutions in France or abroad, or from public or private research centers.

L'archive ouverte pluridisciplinaire **HAL**, est destinée au dépôt et à la diffusion de documents scientifiques de niveau recherche, publiés ou non, émanant des établissements d'enseignement et de recherche français ou étrangers, des laboratoires publics ou privés.



HAL Authorization

Integrating process design and control: An application of optimal control to chemical processes

M. Miranda^a, J.M. Reneaume^{b,*}, X. Meyer^c, M. Meyer^c, F. Szigeti^d

^a Department of Unit Operations, Faculty of Engineering, University of Los Andes (ULA), Mérida, Venezuela

^b Laboratoire de Thermique, Energétique et Procédés (LaTEP), Université de Pau, Rue Jules Ferry, BP 7511, 64075 Pau Cedex, France

^c ENSIACET/Laboratoire de Génie Chimique, 5 rue Paulin Talabot, 31106 Toulouse, France

^d Department of Control Engineering, Faculty of Engineering, University of Los Andes (ULA), Mérida, Venezuela

Abstract

In this paper, the optimal design of process systems generically used in chemical industries is studied. The closely coupled nature of optimal design specification of the equipment, the determination of the optimal process parameters in steady-state, moreover, some issues of the application of optimal control is shown. The solution of the overall optimization problem including (i) optimal design of the equipment and (ii) specification of its optimal control strategy can be found relying on two different design concepts, namely, on the conventionally used sequential or, on the newly emerged simultaneous design approaches. This paper gives the theoretical background of the ideas and presents a comparative summary of the approaches. The two approaches are contrasted to each other in which the effects of the interaction of optimal process design and optimal control is highlighted. A new simultaneous optimization procedure providing economic and operability benefits over the traditional stand-alone approach is proposed. The applicability of the idea is demonstrated by means of a design study carried out for optimal design of a coaxial heat exchanger and a reactive distillation column for the synthesis of ethyl tert butyl ether (ETBE), relying on the benefits of the utilization of optimal control.

Keywords: Optimal process design; Optimal control; Pontryagin's minimum principle; Nonlinear systems; Reactive distillation; Coaxial heat exchanger

1. Introduction

In order to improve the quality of the design of process control systems in the chemical industry, several methods of optimization have been developed in the last decade. Process optimization methods may result in a more economical and safer process operation even under the presence of the unavoidable modeling uncertainties and external disturbances. Traditionally, different optimization methods are used for the specification of the equipment and for determination of the basic process parameters in steady-state. This procedure may be referred as the *design* of the process, for some applications see Refs. [1,2].

Another interesting issue of the process optimization is related to control problems. Up to now, simple PI control configurations, sometimes with optimal tuning of the controller parameters, have been used in controller design practice in the

chemical industry. The application of the idea of optimal control has received some attention quite lately.

Initial research in the optimization of chemical processes focused mainly on the development of the process and control system design as independent *sequential* procedures. It was shown for distillation systems quite recently that tackling the optimization problems of both process design and control *simultaneously* may result in numerous economic benefits over the traditional sequential design approaches, see Refs. [3–6].

It has been recognized early that it has a number of advantages if, beyond traditional concepts of process engineering, some knowledge about the process dynamics is also taken into consideration when the process operation is detailed and the equipment specification is made during planning: active operational management of chemical processes by using *control* with adequate selection of control parameters may contribute to energy efficiency and safety, significantly [7,8]. A classical example of this was shown in Ref. [9], where the product (the output heat) of a tubular reactor was used to preheat the input feed. Even though this application was interesting to show how the utilization of the

* Corresponding author.

E-mail address: jean-michel.reneaume@univ-pau.fr (J.M. Reneaume).

process dynamics may contribute to a more economic process operation, the proposed configuration involves difficult process control problems. The most important message of this application was, however, that, besides the use of the optimization methods of the design in steady-state, it is at least as important to take the dynamics of the process into consideration yet in the early stages of the process specification.

In this paper the effects of the interaction of process design and control is investigated with special focus on the application of optimal control. The basic contribution of this work is the use of the idea of optimal control instead of simple PI schemes in the joint process/controller design. Our work will concentrate on the conception of a process and its optimal control capable to maintain the operative point of the equipment in presence of external disturbances on a certain operation interval so that some predetermined economic criteria are satisfied. In this contribution, the external disturbances are supposed to be known as a function of time (sinusoidal perturbations are generally considered). Uncertain parameters lying in a given interval are out the topics of this paper.

In order to show the advantages of the proposed idea, two basic optimization strategies are compared with each other in this paper. According to the first strategy, which can be viewed as the traditional approach, the optimization of the process design and the related optimal control problems are thought separately and they are considered as sequential design procedures. In the second strategy, process design and control are optimized simultaneously in the same design step.

In the simultaneous design two different solution methods of the optimization problem are proposed. By the first method, process and control design is carried out relying on Pontryagin's minimum principle [10–12]. The Euler-Lagrange equations are derived from the underlying optimization problem which are then solved by using a discretization technique. This method is called the *Optimal Control* approach. According to the second method, the optimal control problem is included in the constraints of the design problem explicitly, which is then solved by using the technique of successive quadratic programming (SQP). This method is called the *Optimal Design* approach. In both cases, the idea of the solution of the original infinite dimensional optimization problem is relied on the discretization of the state and control variables and the optimization problem is considered on a finite time horizon.

The paper is organized as follows. In Section 2 the formulation and the alternative solution methods of the optimization problem which will be discussed in this paper is presented. First, the mathematical concepts of the sequential and simultaneous design strategies are summarized. Then, the idea of the proposed design approaches applied to these strategies (referred as *Optimal Control* and *Optimal Design*) are described in details. It is shown how the application of Pontryagin's minimum principle together with its particular solution methods is embedded in the individual approaches.

For demonstrating the idea proposed in the previous section, the stream of discussion in Section 3 is built around a simple illustrative example in which the optimal design of a coaxial heat exchanger is considered. In Section 4, a more challenging

example, namely, the optimal design of a catalytic distillation process that has received particular attention recently is considered. More precisely, we will consider ethanol and isobutene etherification in order to produce ethyl tert butyl ether (ETBE). The summary of the simulation results concludes the discussion.

2. Problem statement

Let our objective be to design the process together with its optimal control able to maintain feasible operation of the equipment (operability of the process) in the presence of disturbances over a desired time horizon. The problem can be stated as follows:

$$\min_{x(t), x_0, u(t), u_0, d} \omega(d) + S(x(t_f), t_f) + \int_{t_0}^{t_f} g(x(t), u(t), d, t) dt \quad (1)$$

subject to:

$$\dot{x}(t) - f_\theta(x(t), u(t), d, t) = 0, \quad \forall t \in [t_0, t_f] \quad (2)$$

$$x(t_0) - x_0 = 0 \quad (3)$$

$$u(t_0) - u_0 = 0 \quad (4)$$

$$q_\theta(x(t), u(t), d, t) \leq 0 \quad (5)$$

$x \in \mathcal{X} \subset \mathbb{R}^n$ is the vector of state variables, $u \in \mathcal{U} \subset \mathbb{R}^m$ is the vector of manipulated (control) variables and $d \in D_p \subset \mathbb{R}^q$ is the vector of time invariant design variables. In this contribution, design variables are assumed to be continuous. Discrete design variables will be considered in future works. $x_0 \in \mathcal{X} \subset \mathbb{R}^n$ (respect. $u_0 \in \mathcal{U} \subset \mathbb{R}^m$) is the vector of initial conditions of the state variables (respect. control variables).

The objective function (1) to be minimized includes the annualized investment cost $\omega(d)$ and the operating (control) cost. S is the terminal term of the control cost. The function $g(\cdot)$ is assumed to be continuously differentiable with respect to all variables.

Eq. (2) refers to the dynamic process model that results in a set of differential and algebraic equations (DAEs) with the corresponding initial conditions (3) and (4). This model is submitted to process disturbances: notation f_θ is used to indicate that the known time varying perturbation $\theta(t)$ is part of the design setup but $\theta(t)$ itself is not a variable of the problem. The vector field f is assumed to be continuously differentiable. Eq. (5) refers to the generic design constraints. Note that there is no assumption on the control which can be arbitrary function of time except that it is piecewise continuous. The solution of this optimization problem can be found in two different ways as they will be characterized briefly in the following sections.

2.1. Sequential design and control

According to the first strategy, which is followed traditionally in the practice, the optimization of the process design and the related optimal control problems are thought separately and they are considered as sequential design procedures. First, the

design is performed for a specific working point in steady-state. Then, for a given solution of the steady-state design problem, one determines the optimal control in a subsequent optimization step. This two step approach can be summarized as follows.

Step 1. Optimal Design. The optimal design problem in steady-state can be stated as a minimax Nonlinear Programming Problem (NLP):

$$\max_{\theta} \left(\begin{array}{l} \min_{x_0, u_0, d} \omega(d) + (t_f - t_0) g(x_0, u_0, d) \\ \text{s.t.} \\ f_{\theta}(x_0, u_0, d) = 0 \\ q_{\theta}(x_0, u_0, d) \leq 0 \\ x_0 \in X \subset \mathbb{R}^n, \quad u_0 \in U \subset \mathbb{R}^m \\ d \in D_p \subset \mathbb{R}^q \end{array} \right) \quad (6)$$

The basic idea of the solution of this NLP problem (6) is that the performance criterion is minimized with respect to the perturbation θ that maximizes the cost functional, that is to say the worst-case effect of θ .

For sake of simplicity, in this contribution, problem (6) is solved for fixed values θ_0 of θ : minimum value, maximum value and nominal value. Subsequently, the optimal steady-state solutions x_0^*, u_0^*, d^* of the modified problem (6) are used to construct the initial condition of the optimal control problem when the design parameters are fixed at the value set d^* .

Step 2. Optimal Control. The above obtained design (d^*) is now evaluated dynamically in the presence of the perturbations and with consideration of dynamic control constraints. It can be easily seen that, in general, a great number of constraints are violated. The objective is therefore to search for the optimal control rule that ensures the operability of the process according to the performance criterion. The optimal control problem can be formulated as:

$$\left. \begin{array}{l} \min_{x(t), u(t)} S(x(t_f), t_f) + \int_{t_0}^{t_f} g_{d^*}(x(t), u(t), t) dt \\ \text{s.t.} \\ \dot{x}(t) - f_{\theta(t), d^*}(x(t), u(t), t) = 0 \\ q_{\theta, d^*}(x(t), u(t), t) \leq 0 \\ x(t_0) - x_0^* = 0 \\ u(t_0) - u_0^* = 0 \\ x \in \mathcal{X} \subset \mathbb{R}^n, \quad u \in \mathcal{U} \subset \mathbb{R}^m \\ \forall t \in [t_0, t_f] \end{array} \right\} \quad (7)$$

The optimal control problem (7) defined above is then solved using the Pontryagin's minimum principle. This will be detailed in more depth in a subsequent section.

2.2. Simultaneous design and control

In the simultaneous approach the design and the control are optimized simultaneously. If the terminal part $S(x(t_f), t_f)$ in the

performance function (1) is equal to zero, the problem (Eqs. (1)–(5)) is stated as follows:

$$\left. \begin{array}{l} \min_{x(t), x_0, u(t), u_0, d, \xi} \omega(d) + \int_{t_0}^{t_f} g(x(t), u(t), d, t) dt \\ \text{s.t.} \\ \dot{x}(t) - f_{\theta(t)}(x(t), u(t), d, t) = 0 \\ q_{\theta(t)}(x(t), u(t), d, t) + \xi^2 = 0 \\ x(t_0) - x_0 = 0 \\ u(t_0) - u_0 = 0 \\ x \in \mathcal{X} \subset \mathbb{R}^n, \quad u \in \mathcal{U} \subset \mathbb{R}^m \\ x_0 \in \mathcal{X} \subset \mathbb{R}^n, \quad u_0 \in \mathcal{U} \subset \mathbb{R}^m \\ d \in D_p \subset \mathbb{R}^q, \quad \xi \in \mathcal{Z} \subset \mathbb{R}^z \\ t \in [t_0, t_f] \end{array} \right\} \quad (8)$$

where the inequality constraints are transformed into equality constraints by the introduction of slack variables ξ .

For the solution of the optimization problem (8) two different solution strategies are proposed. In the first strategy, the optimal control problem is included in the constraints of the design problem explicitly, which is then solved using an SQP technique. This method was referred as *Optimal Design* strategy in the introduction.

In the second strategy, the design and control optimization is carried out on the basis of Pontryagin's minimum principle. The Euler-Lagrange equations are obtained from the problem of optimization. The algebraic-differential equation system is discretized then solved by the Newton–Raphson numerical method. This was called *Optimal Control* strategy. These optimization strategies are summarized in the following sections.

As the solution of the optimal control problem embedded in both the solution strategies is based on the application of Pontryagin's minimum principle we will, therefore, also present the solution to Pontryagin's minimum principle for the special case when the terminal cost S in the performance function (1) is considered zero. The derivation of the solution is based on the classical calculus of variations as it follows.

2.2.1. Optimal design strategy

The optimization problem (8) can be reformulated as:

$$\left. \begin{array}{l} \min_{x_0, u_0, d} \omega(d) + \mathcal{J}_0(x_0, u_0, d) \\ \text{s.t.} \\ f_{\theta}(x_0, u_0, d) = 0 \\ q_{\theta}(x_0, u_0, d) \leq 0 \\ x_0 \in \mathcal{X} \subset \mathbb{R}^n, \quad u_0 \in \mathcal{U} \subset \mathbb{R}^m \\ d \in D_p \subset \mathbb{R}^q, \end{array} \right\} \quad (9)$$

In problem (9), $\mathcal{J}_0(x_0, u_0, d)$ is given by:

$$\mathcal{J}_0(x_0, u_0, d) = \left(\begin{array}{l} \min_{x(t), u(t), \xi} \int_{t_0}^{t_f} g_d(x(t), u(t), t) dt \\ \text{s.t.} \\ \dot{x}(t) - f_{\theta(t), d}(x(t), u(t), t) = 0 \\ q_{\theta(t), d}(x(t), u(t), t) + \xi^2 = 0 \\ x(t_0) - x_0 = 0 \\ u(t_0) - u_0 = 0 \\ x \in \mathcal{X} \subset \mathbb{R}^n, \quad u \in \mathcal{U} \subset \mathbb{R}^m \\ \xi \in \mathcal{Z} \subset \mathbb{R}^z, \quad t \in [t_0, t_f] \end{array} \right) \quad (10)$$

Problem (10) represents the optimal control problem for the known initial conditions and given design variables. According to Pontryagin's Minimum Principle, a necessary condition for the optimal solution of problem (10) is given as follows:

Let $u^*(t)$ be the optimal control trajectory for the problem (10) and let $x^*(t)$ be the corresponding optimal state trajectory. Then, there exists a differentiable costate n -vector function $\lambda(t)$ and differentiable multipliers $\varphi(t)$, such that:

$$\left. \begin{array}{l} \frac{\partial H}{\partial \lambda} = \dot{x}(t) \rightarrow \dot{x}(t) = f_{\theta(t)}(x(t), u(t), d, t) \\ \frac{\partial H}{\partial \varphi} = 0 \rightarrow q_{\theta(t)}(x(t), u(t), d, t) + \xi^2 = 0 \\ \frac{\partial H}{\partial x} = -\dot{\lambda}(t) \rightarrow -\dot{\lambda}(t) = \left[\frac{\partial g}{\partial x} + \lambda^T(t) \frac{\partial f}{\partial x} + \varphi^T(t) \frac{\partial q}{\partial x} \right] \\ \frac{\partial H}{\partial u} = 0 \rightarrow \left[\frac{\partial g}{\partial u} + \lambda^T(t) \frac{\partial f}{\partial u} + \varphi^T(t) \frac{\partial q}{\partial u} \right] = 0 \\ \frac{\partial H}{\partial \xi} = 0 \rightarrow 2\varphi^T(t) \xi(t) = 0 \end{array} \right\} \quad (11)$$

for all $t \in [t_0, t_f]$. The appropriate state and control boundary conditions (3) and (4) are also added to system (11). The necessary transversality condition occurs:

$$(S_x - \lambda(t))\delta x|_{t=t_f} + (H(t) + S_t)\delta t|_{t=t_f} = 0 \quad (12)$$

for all $t \in [t_0, t_f]$. S_x and S_t are the derivatives of the terminal cost S with respect to the state and the time, respectively, δ is the infinitesimal operator and H is the Hamiltonian of the system which is defined in terms of $g(\cdot)$, $\lambda(\cdot)$ and $\varphi(\cdot)$ as:

$$\begin{aligned} H(x(t), u(t), \lambda(t), \varphi(t), t) &= g(x(t), u(t), t) \\ &+ \lambda^T f_{\theta}(x(t), u(t), t) \\ &+ \varphi^T (q_{\theta}(x(t), u(t), t) + \xi(t)^2) \end{aligned} \quad (13)$$

Since the terminal cost S in Eq. (1) is equal to zero, the transversality condition (12) results as:

$$\lambda(t_f) = 0 \quad (14)$$

Then, including the equations obtained in (11) in the restrictions of problem (9), the overall optimization problem can be stated

as:

$$\left. \begin{array}{l} \min_{x(t), x_0, u(t), u_0, d, \xi} \omega(d) + \int_{t_0}^{t_f} g(x(t), u(t), d, t) dt \\ \text{s.t.} \\ f_{\theta_0}(x_0, u_0, d) = 0 \\ q_{\theta_0}(x_0, u_0, d) \leq 0 \\ \dot{x}(t) - f_{\theta(t)}(x(t), u(t), d, t) = 0 \\ q_{\theta(t)}(x(t), u(t), d, t) + \xi^2 = 0 \\ \dot{\lambda}(t) = - \left[\frac{\partial g}{\partial x} + \lambda^T(t) \frac{\partial f}{\partial x} + \varphi^T(t) \frac{\partial q}{\partial x} \right] \\ \frac{\partial g}{\partial u} + \lambda^T(t) \frac{\partial f}{\partial u} + \varphi^T(t) \frac{\partial q}{\partial u} = 0 \\ 2\varphi^T(t) \xi(t) = 0 \\ x(t_0) - x_0 = 0 \\ u(t_0) - u_0 = 0 \\ \lambda^T(t_f) = 0 \\ x \in \mathcal{X} \subset \mathbb{R}^n, \quad u \in \mathcal{U} \subset \mathbb{R}^m \\ d \in D_p \subset \mathbb{R}^q, \quad \xi \in \mathcal{Z} \subset \mathbb{R}^z \\ t \in [t_0, t_f] \end{array} \right\} \quad (15)$$

Problem (15) results in a NonLinear Dynamic Optimization problem constrained by a set Differential and Algebraic Equations (DAE). One should note that this DAE system corresponds to a Two Point Boundary Value Problem (TPBVP). Various discretization techniques may be used to transform problem (15) into a Nonlinear Programming (NLP) problem that can be solved using an adapted optimization algorithm (SQP in our case). We can refer to this solution approach as the *Explicit Optimal Design* solution approach of problem (15).

For complex chemical processes (such as reactive distillation), the optimization problem may result in a very large sized problem. Too many process variables may cause numerical difficulties (even with small degree of freedom) which tend to make the problem computationally untractable: variable initialization, variable scaling, gradient evaluation. Thus, it is interesting to investigate how to implement an optimization procedure to improve stability and feasibility on this constrained (occasionally large-scale) optimization problem.

For these numerically untractable cases the so called *Implicit Optimal Design* solution method (in contrast to the explicit approach presented above) is proposed as it is shown in Fig. 1.

According to this scheme, the SQP manages the design variables and the initial values of the control variables. The model of the system is solved in steady-state in order to calculate the initial conditions of the state variables. Then the cost functional is computed solving the optimal control problem (10).

2.2.2. Optimal control strategy

In the *Optimal Control* strategy, the Pontryagin's minimum principle is now applied directly to the problem (8).

A new equation is added to system (11): derivatives with respect to the design variables are equal to zero. Necessary

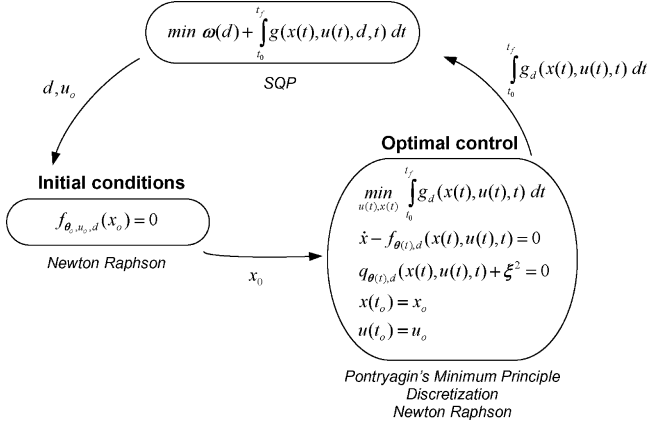

Fig. 1. Algorithmic model of the implicit solution approach.

conditions yield to:

$$\left. \begin{aligned}
 \frac{\partial H}{\partial \lambda} &= \dot{x}(t) \rightarrow \dot{x}(t) = f_{\theta(t)}(x(t), u(t), d, t) \\
 \frac{\partial H}{\partial \varphi} &= 0 \rightarrow q_{\theta(t)}(x(t), u(t), d, t) + \xi^2 = 0 \\
 \frac{\partial H}{\partial x} &= -\dot{\lambda}(t) \rightarrow -\dot{\lambda}(t) = \left[\frac{\partial g}{\partial x} + \lambda^T(t) \frac{\partial f}{\partial x} + \varphi^T(t) \frac{\partial q}{\partial x} \right] \\
 \frac{\partial H}{\partial u} &= 0 \rightarrow \left[\frac{\partial g}{\partial u} + \lambda^T(t) \frac{\partial f}{\partial u} + \varphi^T(t) \frac{\partial q}{\partial u} \right] = 0 \\
 \frac{\partial H}{\partial \xi} &= 0 \rightarrow 2\varphi(t)^T \xi(t) = 0 \\
 \frac{\partial \omega}{\partial d} + \int_{t_o}^{t_f} \left(\frac{\partial H}{\partial d} \right) dt &= 0 \rightarrow \\
 \frac{\partial \omega}{\partial d} + \int_{t_o}^{t_f} \left(\frac{\partial g}{\partial d} + \lambda^T(t) \frac{\partial f}{\partial d} + \varphi^T(t) \frac{\partial q}{\partial d} \right) dt &= 0
 \end{aligned} \right\} (16)$$

for all $t \in [t_o, t_f]$. The appropriate state and control boundary conditions (3) and (4), respectively, are also added to system (16). As said before, since the terminal cost S in Eq. (1) is equal to zero, the transversality condition is equivalent to: $\lambda(t_f) = 0$. H is the Hamiltonian (Eq. (13)).

The DAE system is discretized, then solved by the Newton–Raphson numerical method.

Remark 1. Since at the initial point steady-state is assumed, equation $f_{\theta_o}(x_o, u_o, d) = 0$ is included in system (16). The first equation of system (16), written at $t = t_o$:

$$\dot{x}(t_o) = f_{\theta(t_o)}(x(t_o), u(t_o), d, t_o) = 0$$

Remark 2. The control $u^*(\cdot)$ is a local minimum of the problem (10) if it satisfies Eq. (11) and

$$\frac{\partial^2 H}{\partial u^2} > 0$$

evaluated for $u = u^*$ is positive definite. This condition is called Legendre-Clebsch condition [13]. The *Optimal Design* and *Optimal Control* approaches, as they were presented in

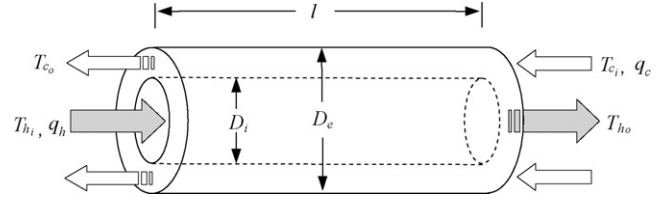

Fig. 2. Schematic diagram of the coaxial heat exchanger.

Sections (2.2.1) and (2.2.2), respectively, are equivalent if the Legendre-Clebsch condition is locally satisfied.

3. Application to a coaxial heat exchanger

In this section, the methodology is illustrated considering a very simple example: a coaxial heat exchanger (CHE). As shown in Fig. 2, typical CHE consists of one pipe placed concentrically inside another larger diameter pipe.

As said before, this is a simplified example: heat capacities are constant; heat transfer between hot and cold streams occurs at average temperature. Then, on the basis of the energy balances, the model of the process is written as:

$$\begin{bmatrix} \dot{T}_{h_o} \\ \dot{T}_{c_o} \end{bmatrix} = \begin{bmatrix} \frac{q_h \rho_h C_{p_h} (T_{h_i} - T_{h_o})}{K_1} - \frac{UA}{K_1} (\bar{T}_h - \bar{T}_c) \\ \frac{q_c \rho_c C_{p_c} (T_{c_i} - T_{c_o})}{K_2} + \frac{UA}{K_2} (\bar{T}_h - \bar{T}_c) \end{bmatrix} \quad (17)$$

where (K_1) and (K_2) coefficients are given by:

$$K_1 = \frac{C_{p_h} \rho_h V_h}{2} \quad \text{and} \quad K_2 = \frac{C_{p_c} \rho_c V_c}{2}, \quad (18)$$

average temperatures (\bar{T}_h) and (\bar{T}_c) are calculated as:

$$\bar{T}_h = \frac{T_{h_i} + T_{h_o}}{2} \quad \text{and} \quad \bar{T}_c = \frac{T_{c_i} + T_{c_o}}{2}, \quad (19)$$

and finally, the heat transfer area (A) and the volume (V_h), respectively (V_c), filled by the *hot*, respectively *cold*, fluid are computed as:

$$A = \pi D_i \ell, \quad V_h = \frac{\pi D_i^2 \ell}{4} \quad \text{and} \quad V_c = \frac{\pi D_e^2 \ell}{4} - V_h \quad (20)$$

In this model (Eqs. (17)–(20)), the state variables are the outlet temperatures of the hot (T_{h_o}) and cold (T_{c_o}) streams:

$$x(t) = [T_{h_o} \quad T_{c_o}]^T$$

The manipulated variable is the volumetric flowrate of the cold stream (q_c):

$$u(t) = q_c$$

The time invariant design parameters are the diameter of the inner tube (D_i) and the total length of the equipment (ℓ):

$$d = [D_i \quad \ell]^T$$

The temperature of the inlet hot flow is subject to a sinusoidal disturbance:

$$T_{h_i} = 338.7 + 2.22 \sin(1.55t) \quad (21)$$

Table 1
Parameter values of the heat exchanger

Parameter	Notation	Value
Specific heat capacity of hot fluid (J/(kg K))	C_{ph}	1666.34
Specific heat capacity of cold fluid (J/(kg K))	C_{pc}	3914.65
Hot flow rate (m ³ /s)	q_h	7.865e-4
External diameter (m)	D_e	0.05
Density of hot fluid (kg/m ³)	ρ_h	881.01
Density of cold fluid (kg/m ³)	ρ_c	1021.17
Heat transfer coefficient (W/(m ² K))	U	401.51
Inlet temperature of the cold stream (K)	T_{c_i}	299.5

The time invariant, known parameters are given in Table 1.

The objective is to determine the design parameters (d) of the CHE together with its optimal control ($u(t)$) which is able to maintain, at minimum annual total cost, the temperature of the hot side (T_{h_o}) in the close vicinity of a reference temperature ($T_{h_o}^{\text{ref}}$) over a finite time horizon of interest, in the presence of disturbances in the temperature of the hot flow (T_{h_i}). Constraints related to the maximum and minimum pressure drops for both streams are included in the problem. For sake of controllability, the manipulated variable ($u(t) = q_c$) is also maintained in the close vicinity of its nominal capacity.

3.1. Sequential design and control

According to the first strategy presented before, the optimal design and the related optimal control problems are thought separately and they are considered as sequential procedures as it is followed traditionally in the practice. For the CHE design described previously, the steady-state optimal design problem can mathematically be stated as follows:

$$\left. \begin{aligned} & \min_{D_i, \ell, u(0), x(0)} c_1 A + t_f(c_2 u(0) + c_3 \Delta P_c u(0) + c_4 \Delta P_h q_h) \\ & \text{s.t.} \\ & F(x(0), u(0), D_i, \ell) = 0 \\ & Ve_h \geq 0.45 \\ & Ve_c \geq 0.45 \\ & x_1(0) = T_{h_o}^{\text{ref}} \end{aligned} \right\} (22)$$

in which c_i are the different cost coefficients. The total capital cost is proportional to the heat transfer area: ($c_1 = 592.0 \text{ \$/m}^2$). Operating cost includes the cost of the cold water ($c_2 = 0.0264 \text{ \$/m}^3$) and the cost of the two pumps ($c_3 = c_4 = 15e^{-4} \text{ \$/W/h}$). t_f is the total operating time of the process supposing the life-cycle of the equipment is 15 years and the yearly rate of operation is 6000 h/year. It is also assumed that the operation of the process is periodic over the cycles of 8 h. ΔP_h , respectively ΔP_c , is the pressure drop in the pump operating at the hot, respectively cold, side. Pressure drops are calculated from the Fanning equation:

$$\Delta P_h = \frac{2\ell f_c \rho_h Ve_h^2}{D_i} \quad \text{and} \quad \Delta P_c = \frac{2\ell f_c \rho_c Ve_c^2}{D_e - D_i} \quad (23)$$

where (f_c) is the Fanning factor (equal to 0.001) and (Ve_h), respectively (Ve_c), is the velocity of the hot, respectively cold,

Table 2
Coaxial heat exchanger—state and design variables and costs: Best-case, nominal and worst-case steady-state designs

	Best-case	Nominal	Worst-case
T_{c_o} (K)	309	310	311
Diameter (m)	3.78e-2	3.75e-2	3.71e-2
Length (m)	28.26	29.96	31.95
Cold flow rate (m ³ /s)	4.30e-4	4.36e-4	4.75e-4
Investment cost (\\$)	639.35	676.25	710.27
Operating cost (\\$)	251.87	266.60	280.21
Total cost (\\$)	891.24	942.82	990.49

fluids:

$$Ve_h = \frac{4q_h}{\pi D_i^2} \quad \text{and} \quad Ve_c = \frac{4u}{\pi(D_e^2 - D_i^2)} \quad (24)$$

The first constraint includes the process model (17) in steady-state ($t = 0$). The inequality constraints are relative to the required minimum water speed ($Ve_{\text{min}} = 0.45 \text{ m/s}$) in the pipes. Recall that higher water speed improves the heat transfer and minimizes fouling. The last constraint ensures that the process reaches its objective: the output temperature of the hot fluid should be equal to the reference 314.81 K.

The above NLP problem (22) is solved using an SQP method. Three cases were considered according to the value of inlet hot temperature: (a) *nominal case*: the inlet hot temperature was fixed at its nominal value (338.70 K), (b) *worst-case*: the inlet hot temperature was set to its highest value (340.92 K), (c) *best-case*: the inlet hot temperature was set to its lowest value (336.48 K).

Table 2 summarizes the capital costs along with the optimal value of the design variables. It can be seen that for the worst-case design, a significant 5.05% additional cost (back-off) is required with respect to the nominal economic optimum. This is due to increased capital cost with over-design of the heat transfer area of the CHE.

All the design setups were dynamically tested by simulation, in the presence of the sinusoidal disturbance on the inlet hot temperature. It can be easily shown that in order to be able to maintain feasibility of the operation (respect to the constraint relative to the velocity and the output temperature of the hot fluid) the utilization of control is required. In our case, an optimal control scheme is adopted. The performance criterion includes both economic and controllability criteria: minimize the total cost while maintaining the hot temperature and the cold flow at their reference values $T_{h_o}^{\text{ref}}$ and q_c^{ref} . This performance requirement can be formulated as a quadratic cost function:

$$J = \frac{1}{2} \int_0^{t_f} [c_2 u(t) + c_3 \Delta P_c u(t) + c_4 \Delta P_h q_h + c_5 (u(t) - q_c^{\text{ref}})^2 + c_6 (x_1(t) - T_{c_o}^{\text{ref}})^2] dt \quad (25)$$

The Hamiltonian of the system can be written as:

$$H = \frac{1}{2} (c_2 u + c_3 \Delta P_c u + c_4 \Delta P_h q_h$$

$$\begin{aligned}
& +c_5(u - q_c^{\text{ref}})^2 + c_6(x_1 - T_{h_0}^{\text{ref}})^2 \\
& +\lambda_1 \left(\frac{q_h \rho_h C_{p_h} (T_{h_1} - x_1)}{K_1} - \frac{UA}{K_1} (\bar{T}_h - \bar{T}_c) \right) \\
& +\lambda_2 \left(\frac{u \rho_c C_{p_c} (T_{c_i} - x_2)}{K_2} + \frac{UA}{K_2} (\bar{T}_h - \bar{T}_c) \right) \\
& +\varphi_1 \left(\frac{-4q_h}{\pi D_i^2} + 0.45 + \xi_1^2 \right) \\
& +\varphi_2 \left(\frac{-4u}{\pi(D_e^2 - D_i^2)} + 0.45 + \xi_2^2 \right)
\end{aligned} \tag{26}$$

where λ_i and φ_i are the co-state and multipliers variables, respectively. By the application of Pontryagin's minimum principle (system (11)), the optimal control problem results in the following DAE system:

- Process model: Eq. (17)

- Minimum velocity constraints:

$$\frac{-4q_h}{\pi D_i^2} + 0.45 + \xi_1^2 = 0 \tag{27}$$

$$\frac{-4u}{\pi(D_e^2 - D_i^2)} + 0.45 + \xi_2^2 = 0 \tag{28}$$

- Adjoint system:

$$\dot{\lambda}_1 = -c_6(x_1 - T_{h_0}^{\text{ref}}) + \lambda_1 \left(\frac{q_h \rho_h C_{p_h}}{K_1} + \frac{UA}{2K_1} \right) - \lambda_2 \frac{UA}{2K_2} \tag{29}$$

$$\dot{\lambda}_2 = -\lambda_1 \frac{UA}{2K_1} + \lambda_2 \left(\frac{u \rho_c C_{p_c}}{K_2} + \frac{UA}{2K_2} \right) \tag{30}$$

$$\varphi_1 \xi_1 = 0, \quad \varphi_2 \xi_2 = 0 \tag{31}$$

- Optimal control equation:

$$\begin{aligned}
& \frac{1}{2}c_2 + c_3 \left(\frac{96fcu^2\rho_c\ell}{(D_e - D_i)(D_e^2 - D_i^2)\pi} \right) \\
& +c_5(u - q_c^{\text{ref}}) + \lambda_2 \frac{\rho_c C_{p_c} (T_{c_i} - x_2)}{K_2} \\
& -\varphi_2 \frac{4}{\pi(D_e^2 - D_i^2)} = 0
\end{aligned} \tag{32}$$

This system includes four differential equations, nine equations altogether. There are nine independent variables: the state variables (T_{h_0} and T_{c_0}), the co-state variables (λ_1 and λ_2), the multipliers (φ_1 and φ_2), the slack variables (ξ_1 and ξ_2) and the control variable (q_c). Boundary conditions include final conditions on the co-state variables (14) and initial conditions on the state variables: $(x(0))$ is solution of the steady-state design problem (22), considering the nominal value of the perturbed variable.

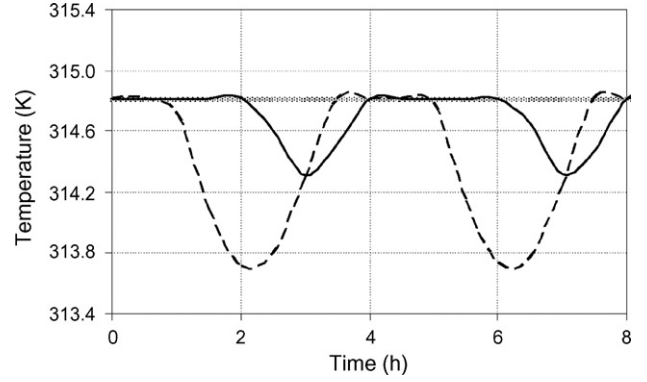

Fig. 3. Output temperature of the hot fluid for different design setups: nominal case (continuous line), worst-case (ragged line), best-case and reference (grey line).

Fig. 3 shows the profiles of the temperature of the hot fluid. It should be noted that, for both the nominal and the worst-case, the optimal control can not maintain the outlet hot temperature in the close vicinity of the reference over the entire time horizon: when the minimum velocity constraint is saturated (Fig. 4), the gap between the outlet hot temperature and the reference temperature increases.

The optimal control can maintain the temperature of the hot fluid over the entire time horizon only in the best-case. Indeed, this case has been optimized for a minimal input temperature of the hot fluid which results in an under-sized design. The control respects the minimum velocity constraints (0.45 m/s) and maintains the output temperature of the hot fluid at its reference value.

Table 3 shows the operating costs obtained for the system subject to perturbations while using the sequential approach. Of course time invariant design parameter and investment cost are the same as those presented in Table 2. *Operating cost 1* is the cost of water and the operating cost of the pumps. *Operating cost 2* is the penalty cost associated with the deviation between the output temperature of the hot fluid and the reference temperature. As said before, Operating cost 2 is equal to zero only for

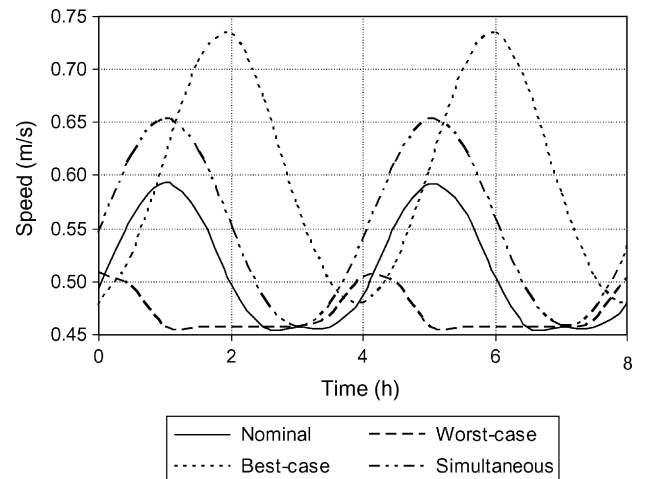

Fig. 4. Water speed at the cold side for sequential and simultaneous approach.

Table 3

Comparison of sequential and simultaneous strategies

	Best-case	Nominal	Worst-case	Simultaneous
Diameter (m)	3.78e-2	3.75e-2	3.71e-2	3.93e-2
Length (m)	28.26	29.96	31.95	29.07
Flow rate reference (m ³ /s)	4.30e-4	4.36e-4	4.75e-4	4.41e-4
Investment cost (\$)	639.35	676.25	710.27	683.57
Operating cost 1 (\$)	312.16	259.85	260.14	263.42
Operating cost 2 (\$)	0.0	3.42	3.55	0.0
Total cost 1 (\$)	951.53	936.10	970.42	947.00
Total cost 2 (\$)	951.53	939.52	973.97	947.00

the best-case. Comparing Operating cost 1 for the dynamic process (Table 3) and Operating cost for the steady-state (Table 2), one should note that, for the best-case, dynamic operation cost is greater than steady-state operating cost. Input temperature of the hot fluid will always be higher or equal to the reference temperature of the design requirements. Consequently, the cold water flowrate will always be higher or equal to the reference flux in order to be able to satisfy the minimum speed constraint. At the opposite, for the nominal and the worth cases, the dynamic operating cost is lower than the steady-state operating cost.

3.2. Simultaneous design and control

In order to determine the design parameters (D_i , ℓ) and the optimal control profiles simultaneously, the CHE illustrative example has been solved using to the two approaches presented earlier. According to the *Optimal Design* approach [14], investment cost is included in expression (25) as follows:

$$J = c_1\pi D_i \ell + \frac{1}{2} \int_0^{t_f} [c_2 u(t) + c_3 \Delta P_c u(t) + c_4 \Delta P_h q_h + c_5 (u(t) - q_c^{\text{ref}})^2 + c_6 (x_1(t) - T_{c_o}^{\text{ref}})^2] dt \quad (33)$$

Then J is minimized and this minimization is subject to the following constraints:

- Process model (17)
- Minimum velocity constraints (27) and (28)
- Adjoint system (29)–(31)
- Optimal control Eq. (32)

The optimization variables are: the state variables (T_{h_o} and T_{c_o}), the co-state variables (λ_1 and λ_2), the multipliers (φ_1 and φ_2), the slack variables (ξ_1 and ξ_2), the control variable (q_c) and the time invariant design parameters (ℓ) and (D_i). The problem has been solved using a SQP algorithm. For this simple example, the *Explicit Optimal Design* solution strategy has been used.

According to the procedure proposed as the *Optimal Control* approach, the Hamiltonian is modified including the investment

cost relative to the design parameters:

$$H = c_1\pi D_i \ell + \frac{1}{2}(c_2 u + c_3 \Delta P_c u + c_4 \Delta P_h q_h + c_5 (u - q_c^{\text{ref}})^2 + c_6 (x_1 - T_{h_o}^{\text{ref}})^2) + \lambda_1 \left(\frac{q_h \rho_h C_{p_h} (T_{h_i} - x_1)}{K_1} - \frac{UA}{K_1} (\bar{T}_h - \bar{T}_c) \right) + \lambda_2 \left(\frac{u \rho_c C_{p_c} (T_{c_i} - x_2)}{K_2} + \frac{UA}{K_2} (\bar{T}_h - \bar{T}_c) \right) + \varphi_1 \left(\frac{-4q_h}{\pi D_i^2} + 0.45 + \xi_1^2 \right) + \varphi_2 \left(\frac{-4u}{\pi (D_c^2 - D_i^2)} + 0.45 + \xi_2^2 \right) \quad (34)$$

Applying Pontryagin's minimum principle, Eqs. (17) and (27)–(32) are obtained. Furthermore, as said before (system (16)), additional equations are derived: derivatives with respect to the design parameters:

- Derivative with respect to the CHE length

$$\frac{\partial \omega}{\partial \ell} + \int_{t_o}^{t_f} \left(\frac{\partial H}{\partial \ell} \right) dt = 0$$

then

$$c_1\pi D_i + \int_{t_o}^{t_f} \left(c_3 \left(\frac{32 f_c \rho_c u^3}{\pi^2 (D_c - D_i) (D_c^2 - D_i^2)^2} \right) + c_4 \left(\frac{32 f_c \rho_h q_h^3}{\pi^2 D_i^5} \right) - \lambda_1 \left(\frac{8 q_h (T_{h_i} - x_1)}{\pi \ell^2 D_i^2} \right) - \lambda_2 \left(\frac{8 u (T_{c_i} - x_2)}{\pi \ell^2 (D_c^2 - D_i^2)} \right) \right) dt = 0 \quad (35)$$

- Derivative with respect to the CHE internal diameter

$$\frac{\partial \omega}{\partial D_i} + \int_{t_o}^{t_f} \left(\frac{\partial H}{\partial D_i} \right) dt = 0$$

then

$$c_1\pi\ell + \int_{t_0}^{t_f} \{c_3\} \left(\frac{32f_c\rho_c\ell u^3}{\pi^2} \frac{D_e + 5D_i}{(D_e - D_i)(D_e^2 - D_i^2)^2} \right) - c_4 \left(\frac{160f_c\rho_h\ell q_h^3}{\pi^2 D_i^6} \right) - \lambda_1 \left(\frac{16q_h(T_{c_i} - x_1)}{\pi D_i^3 \ell} - \frac{8U}{D_i^2 \rho_h C_{p_h}} (\bar{T}_h - \bar{T}_c) \right) - \lambda_2 \left(\frac{16uD_i(x_2 - T_{c_i})}{\pi\ell(D_e^2 - D_i^2)^2} - \left(\frac{8U}{(D_e^2 - D_i^2)\rho_c C_{p_c}} + \frac{16UD_i^2}{(D_e^2 - D_i^2)^2 \rho_c C_{p_c}} \right) (\bar{T}_h - \bar{T}_c) \right) + \varphi_1 \left(\frac{8q_h}{\pi D_i^3} \right) - \varphi_2 \left(\frac{8uD_i}{\pi(D_e^2 - D_i^2)^2} \right) dt = 0 \quad (36)$$

The whole system includes 11 equations: (17), (27)–(32), (35) and (36). There are four differential equations and 11 independent variables: the state variables (T_{h_0} and T_{c_0}), the co-state variables (λ_1 and λ_2), the multipliers (φ_1 and φ_2), the slack variables (ξ_1 and ξ_2), the control variable (q_c) and the time invariant design parameters (ℓ) and (D_i). The above system is discretized and the resulting algebraic nonlinear equations are solved using a Newton–Raphson technique. ($11 \times n$) Equations, where n is the number of discretization points, are to be solved.

Within the simultaneous approach, both the Optimal Design and the Optimal Control solution strategies have been used. As expected, the optimization variables (state variables, time invariant design variables and control variables) have the same optimal values: the two solution strategies are equivalent from a mathematical point of view. For such a simple example, the two formulations are also equivalent if one considers the numerical performances and the formulation load. The second point, which is the main conclusion, is that a feasible solution is achieved: the control can maintain the temperature of the hot fluid on the entire time horizon. In Table 3, these results are compared to those obtained according to the sequential approach.

For comparison between the sequential and simultaneous approaches, only the sequential best-case can be selected: performance requirements are satisfied only for this case (then operative cost 2 is equal to zero).

Comparing the different costs, one should note that the simultaneous strategy results in capital cost 6.91% higher than the sequential one. On the other hand, it provides significantly lower operating cost (15.61% less). Finally, for this example, the total cost is lightly reduced.

It can be interesting to consider a constraint for the maximal speed of the flowrate (problem of erosion for example). The new problem in steady-state can be written as:

$$\left. \begin{array}{l} \min_{D_i, \ell, u(0), x(0)} c_1 A + t_f(c_2 u(0) + c_3 \Delta P_c u(0) + c_4 \Delta P_h q_h) \\ \text{s.t.} \\ F(x(0), u(0), D_i, \ell) = 0 \\ 0.65 \geq V_{e_h} \geq 0.45 \\ 0.65 \geq V_{e_c} \geq 0.45 \\ x_1(0) = T_{h_0}^{\text{ref}} \end{array} \right\} (37)$$

All the simulations were repeated using the new constraints. The results obtained for the design in steady-state are the same as those presented in Table 2: the new constraints are not saturated.

Table 4

Simultaneous design strategy with minimal and maximal velocity constraints

	Simultaneous
Diameter (m)	4.03e-2
Length (m)	29.52
Flow rate reference (m ³ /s)	4.05e-4
Investment cost (\$)	710.29
Operation cost 1 (\$)	241.22
Operation cost 2 (\$)	0.0
Total cost 1 (\$)	951.51
Total cost 2 (\$)	951.51

Nevertheless new design has been obtained for the simultaneous approach (see Table 4).

Then, we calculated the new optimal control. Fig. 5 shows the output temperature and velocity variation for the best-case and the new simultaneous case. It is interesting to note that when the speed reaches its constrained maximal value, the control saturates and it is not possible to maintain the reference temperature [6].

Therefore, in this case, the sequential approach does not permit to find an acceptable control, which underlines the usefulness of the simultaneous approach. Indeed, Fig. 5 a shows that the maximal speed is never reached when the simultaneous approach is applied. The control is not therefore ever saturated and the reference is always maintained.

3.3. Conclusion

This simple example illustrates the fact that the more constrained the problem is, the more difficult it is to obtain a feasible process operation using the sequential solution strategy: considering the minimum fluid velocity constraints, only the sequential best-case is feasible on the whole time interval; considering the additional maximum velocity constraint, the hot fluid temperature can not be maintained at its reference value, even in the sequential best-case.

On the other hand, using the simultaneous solution strategy, a better process operability can be achieved: the hot fluid temperature is maintained at its reference value. Of course, it is not always possible to achieve a feasible solution, even with the simultaneous solution strategy: decreasing the upper bound of the cold fluid speed, D_i will decrease and, consequently, the speed of the hot fluid (interior tube) will increase. If one reaches the upper bound of the hot fluid speed, the problem will not have a feasible solution.

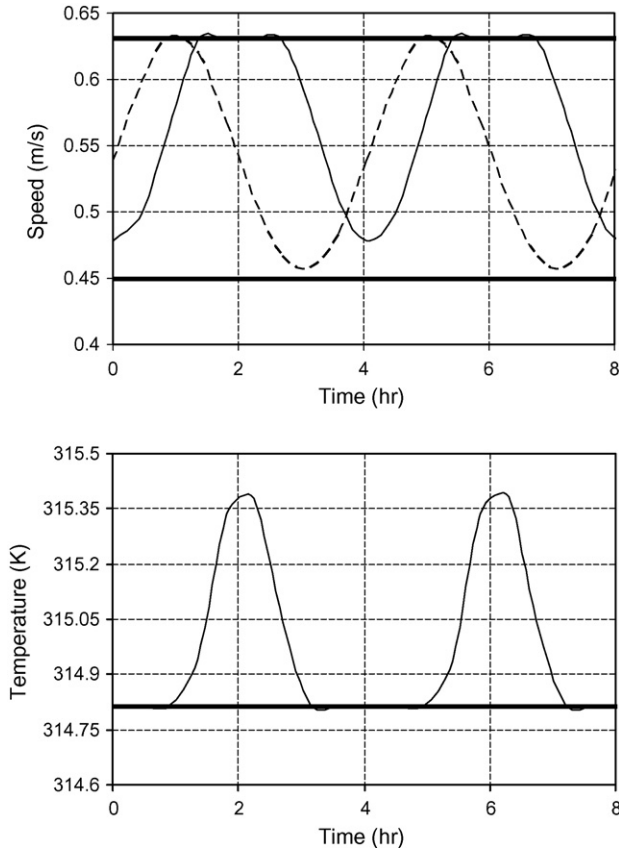

Fig. 5. (a) Water velocity at the cold side for the sequential design best-case (continuous line) and the simultaneous approach (ragged line) with minimal and maximal velocity constraints (b) deviation of the output temperature of hot fluid from the reference (grey line) for the sequential design when minimal and maximal velocity constraints are applied.

On such an example, operability benefits are greater than economic benefits.

4. Application to the catalytic distillation

In this example the production of ETBE from the etherification of isobutylene with ethanol is considered in a catalytic distillation column (Fig. 6). The reaction takes place on tray 4, 5 and 6 of the column: 400 g of Amberlyst 15 Wet is introduced on each reactive stage. Ethanol is fed on tray 3 and butenes are fed on tray 8. Inlet streams are described in Table 5. Operating pressure is equal to 9.5 kPa. The column is modelled using the classical Mass Equilibrium Summation Heat (MESH) equations: vapor–liquid equilibrium is assumed on each stage (except total condenser). The combination of alcohol, olefin and ether forms a highly non-ideal liquid phase and azeotropes have been detected experimentally [15]. Liquid nonideality is modelled using the UNIFAC model. For reactive stages, the mass balances are modified by the introduction of a reaction term. The kinetic law is taken from Ref. [16]. Liquid hold-up is evaluated using the Francis correlation. More information on the catalytic distillation process can be found in Ref. [5].

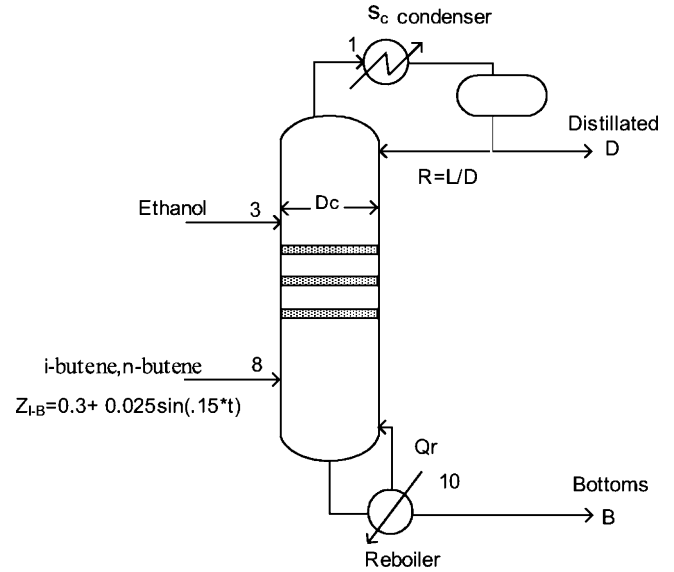

Fig. 6. Reactive distillation column for ETBE process.

The objective is to determine the design parameters (diameter of the column D_c , area of the condenser S_c and flow rate of the butene feed F_a) together with its optimal control, at minimum annual total cost, when the butene feed is subject to a sinusoidal disturbance in its composition (i -butene/ n -butene) given by:

$$z_{iB} = 0.3 + 0.025 \sin(0.15t) \quad (38)$$

The control variables are the reflux (R) and the reboiler duty (Q_r). Then, one needs to seek for the optimal control that maintains the ETBE composition at the bottom of the column, as close as possible to a reference value: $x^{\text{ref}} = 0.83$.

4.1. Sequential design and control

The optimal design problem, in steady-state, is stated as follows:

Table 5
ETBE reactive distillation column characteristics

Fixed operating parameters	Value
Feed 1	
Stage	3
Flow rate (mol/s)	0.02853
Temperature (K)	323
Composition	
Ethanol (mol%)	100
Feed 2	
Stage 8	951.51
Temperature (K)	342.38
Composition (nominal)	
<i>n</i> -Butene (mol%)	70
<i>i</i> -Butene (mol%)	30
Pressure (kPa)	9.5

$$\left. \begin{array}{l} \min_{x, D_c, S_c, F_a, Q_r, R} C_{\text{inv}} + C_{\text{op}} \\ \text{s.t.} \\ f(x, D_c, S_c, F_a, Q_r, R) = 0 \\ D_c \geq D_{\text{min}} \\ x_{\text{ETBE,ne}} = x^{\text{ref}} \end{array} \right\} \quad (39)$$

The minimized objective function is equal to the total annualized cost. It includes the investment cost (C_{inv}):

$$C_{\text{inv}} = C_{\text{col}} + C_{\text{tray}} + C_{\text{cond}}$$

where (C_{col}) is the annualized installed cost of the column shell:

$$C_{\text{col}} = \frac{1}{5} \left(\frac{\text{M\&S}}{280} \right) 101.9 D_c^{1.066} H_c^{0.802} (2.18 + F_c) F_{\text{fac}}$$

(C_{tray}) is the cost of the internal parts of the column:

$$C_{\text{tray}} = \frac{1}{5} \left(\frac{\text{M\&S}}{280} \right) 4.7 D_c^{1.55} N_a F_c F_{\text{fac}}$$

and (C_{cond}) is the annualized installed cost of the condenser [17]:

$$C_{\text{cond}} = \frac{1}{5} \left(\frac{\text{M\&S}}{280} \right) 101.3 S_c^{0.65} F_c$$

(M&S) is the Marshall and Swift index (1050). (H_c) corresponds to the column height (1.5 ft). (F_c) is a material factor (equal to unity in our case for stainless steel at the operating pressure). (F_{fac}) is a scale factor (equal to 2). The operating cost (C_{op}) is calculated as follows:

$$C_{\text{op}} = c_1 Q_r + c_2 F_w + c_3 F_a - c_4 B$$

in which c_i are the costs of the exchanger duties, the raw material and the product. Table 6 shows the numerical values of the different costs.

In the first constraint of problem (39), f represents the steady-state process model: equilibrium model using MESH equations. The inequality constraint refers to the minimum column diameter calculated using the equation proposed by [18]. In order to solve the corresponding Nonlinear Programming Problem (NLP), a Successive Quadratic Programming (SQP) method has been used [19]. Three cases are considered according to the value of feed 2 composition (perturbed variable): (a) *nominal case*: the composition is fixed at its nominal value in *i*-butene (0.3/07 *i*-butene/*n*-butene), (b) *worst-case*: the composition is set to its

Table 6
ETBE reactive distillation column: coefficients for the evaluation of the operating costs

Unit	
Vapor cost c_1	8.055e-6 US\$ kW ⁻¹
Cooling water cost c_2	2.642e-5 US\$ kg ⁻¹
Materials	
Butene cost c_3	8.25e-3 US\$ mol ⁻¹
Product	
ETBE cost c_4	25.3e-3 US\$ mol ⁻¹

Table 7
Catalytic Distillation design variables and costs: best-case, nominal and worst-case steady-state design

		Best-case	Nominal	Worst-case
Diameter (m)	D_c	9.222e-2	9.533.e-2	9.874e-2
Condenser area (m ²)	S_c	0.348	0.3695	0.392
Feed rate (mol/s)	F_a	7.555e-2	8.179e-2	8.9315e-2
Reboiler duty (kW)	Q_r	4.139	4.428	4.758
Reflux	R	3.964	3.659	3.361
Water cost (\$)		35.57	37.36	39.41
Vapor cost (\$)		996.47	1065.90	1145.33
Profit ETBE (\$)		20398.18	20214.15	20014.90
Investment cost (\$)	C_{inv}	661.68	685.78	712.33
Operating cost (\$)	C_{op}	-741.73	1051.52	3187.09
Total cost (\$)		-80.04	1737.31	3899.51

lowest value in *i*-butene (0.275/0.725) and (c) *best-case*: the composition disturbance is set to its highest value in *i*-butene (0.325/0.675). Table 7 summarizes the capital cost along with the optimal value of the design variables.

It can be seen that for the worst-case design a significant 124.25% additional cost is required with respect to the nominal economic optimum. This is due to the necessity to increase the flow rate of butene feed in order to compensate the lowering of the fraction in isobutene. Note that the reaction is equimolar in Ethanol and isobutene. In the best-case, the increased fraction in isobutene is compensated decreasing the butene flow rate. Of course, the diameter of the column increases with the feed rate.

All the design setups were tested by a dynamic process simulation. It can be easily seen that, in order to be able to maintain feasibility of the operation in the presence of the sinusoidal inlet composition disturbance, the utilization of some control policy is required. In our case, an optimal control scheme is adopted. The performance criterion of the optimal control is to maintain the ETBE composition at a reference value (x^{ref}). Reflux and reboiler duty are also maintained in the vicinity of their reference values, while minimizing the operating cost. This performance criterion can be formulated as a quadratic cost function:

$$J = \int_0^{t_f} (P_1(x^{\text{ref}} - x_{\text{ETBE,ne}})^2 + P_2(R^{\text{ref}} - R)^2 + P_3(Q_r^{\text{ref}} - Q_r)^2 + C_{\text{op}}) dt \quad (40)$$

where P_i are constants associated to the particular cost types.

Table 8
Catalytic distillation: costs of the optimal control problem (sequential strategy)

	Best-case	Nominal	Worst-case
Water cost (\$)	41.48	37.15	39.42
Vapor cost (\$)	1041.80	1063.42	1107.17
Profit ETBE (\$)	18628.14	20259.15	21965.73
Investment cost (\$)	661.68	685.78	712.33
E (\$)	0.151	0.154	0.211
Operating cost (\$)	1284.9	1005.77	1368.14
Total cost (\$)	1946.58	1691.55	2080.47

Table 9

Comparison of the optimal solutions: time invariant optimization variables and costs

		Sequential nominal	Simultaneous	Simultaneous*
Diameter (m)	D_c	9.533e-2	9.464e-2	9.464e-2
Condenser area (m ²)	S_c	0.3695	0.3699	0.3619
Feed rate (mol/s)	F_a	8.179e-2	8.181e-2	8.181e-2
Reboiler duty (kW)	Q_r^{ref}	4.428	4.350	4.350
Reflux	R^{ref}	3.659	3.585	3.585
Water cost (\$)		37.15	35.93	37.11
Vapor cost (\$)		1063.42	1047.01	1046.92
Profit ETBE (\$)		20259.15	20243.10	20242.99
Investment cost (\$)	C_{inv}	685.78	681.21	679.94
Operating cost (\$)	C_{op}	1005.77	1008.11	1010.18
Total cost (\$)		1691.55	1689.31	1690.12

Table 8 shows the operating costs obtained while solving the optimal control problem (11) using the Pontryagin's Minimum Principle.

It can be seen that, in each case, the optimal control maintains the system in the vicinity of the reference ETBE composition over the entire time horizon: the value of the term $E = P_1 \int_0^{t_f} (x^{\text{ref}} - x_{\text{ETBE,ne}})^2$ is quite small.

As expected, this result is similar to the one obtained with the heat exchanger example (Table 3): the smallest total cost is obtained for the nominal case.

4.2. Simultaneous design and control

In the simultaneous approach, the design and the control are optimized simultaneously, using an objective function that includes both the performance of the design and the control:

$$J = C_{\text{inv}} + \int_0^{t_f} (P_1(x^{\text{ref}} - x_{\text{ETBE,ne}})^2 + P_2(R^{\text{ref}} - R)^2 + P_3(Q_r^{\text{ref}} - Q_r)^2 + C_{\text{op}}) dt \quad (41)$$

According to the simultaneous approach (problem (8)), the above modified objective function is minimized. The optimization variables include the time invariant design parameter:

$$d = [D_c, S_c, F_a]^T$$

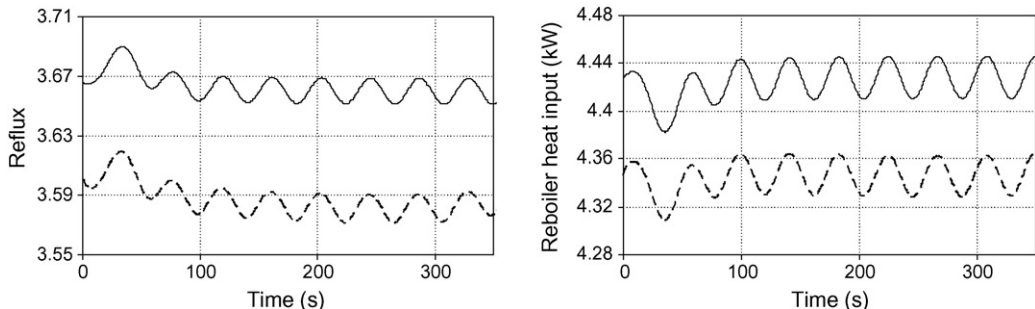

Fig. 7. Comparison of the optimal solutions: reflux and reboiler duty for the sequential approach (continuous line) and simultaneous approach (ragged line).

the control variables and their initial conditions (reference values):

$$u(t) = [R(t), Q(t)]^T \quad \text{and} \quad u_0 = [R^{\text{ref}}, Q^{\text{ref}}]^T$$

and the state variables ($x(t)$), with their initial conditions (x_0). According to the Equilibrium model, state variables are, for each equilibrium stage: vapor and liquid compositions, vapor and liquid flow rates, temperature, liquid hold-up. This minimization is submitted to a set of constraints that includes the dynamic process model, the minimum diameter constraint and the perturbation law.

The total number of variables is equal to $((2nc + 10)(ne - 2) + 2(2nc + 8) + 6)np$ where (np) is the number of discretization points, (nc) the number of components and (ne) the number of trays of the column. Since this model is quite complex, we have used the *Implicit Optimal Design* solution strategy (cf. Section (2.2.1) and Fig. 1): for the considered example, with 600 discretization points, the optimal control sub-problem results in a nonlinear algebraic system with more than 110,000 variables and equations. The great sparsity of the Jacobian, matrix (more than 99.9% of the elements are equal to zero) has been exploited. In order to reduce the computational load, analytical derivatives have been generated.

The results of the sequential and the simultaneous optimization methods are presented in Table 9. The considered sequential optimization is the Nominal case. Optimal values of the time invariant optimization variables are presented together with the different costs.

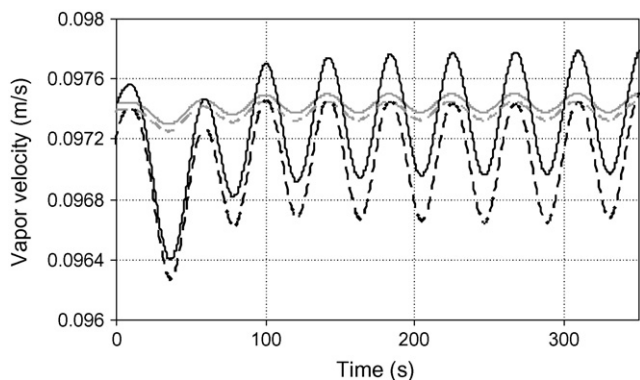

Fig. 8. Vapor velocity (black) and maximum vapor velocity (grey): sequential approach (continuous line) and simultaneous approach (ragged line).

In this example, the different costs are not really affected by the solution strategy. The optimal control policy (Fig. 7) are also quite similar. Reflux and reboiler duty are lower in the case of the simultaneous approach. Furthermore, the amplitude of the sinusoidal variation is lower in the simultaneous approach. This is a first interesting result from a process operation point of view.

As said before, a minimum diameter constraint is considered. The minimum diameter calculation is obtained from the maximum velocity of the vapor phase in the column: the column is designed to operate at 80% of the flooding velocity. Therefore, flooding velocity is a function of vapor properties (temperature, composition, etc.) which are time dependent. It also depends on the geometrical parameters of the plate. In this study, these parameters (weir height, weir length, etc.) are supposed to be fixed and known. In Fig. 8, the vapor velocities for both the sequential and the simultaneous approaches are compared to the maximum velocities. For the simultaneous approach, the constraint is satisfied over the entire time horizon. At the opposite, with the sequential approach, flooding may occur since the constraint is violated.

For some practical reasons, it can be interesting to consider a new constraint: outlet temperature of the cold utility (T_w) (water stream from the condenser) should be lower than a maximum value. Considering the sequential approach, at the design step, the new optimization problem in steady-state is modified as follows:

$$\left. \begin{array}{l} \min_{x, D_c, S_c, F_w, Q_r, R} C_{inv} + C_{op} \\ \text{s.t.} \\ f(x, D_c, S_c, F_a, Q_r, R, F_w) = 0 \\ D_c \geq D_{min} \\ x_{ETBE,ne} = x^{ref} \\ T_w \leq 325.5 \text{ K} \end{array} \right\} \quad (42)$$

Note that the results obtained for problem (42) are the same as those presented in Table 9 (problem (39)): the new constraint is not limiting. For the simultaneous approach, however, the optimal design parameters are lightly altered. The results are presented in Table 9 (column entitled ‘Simultaneous*’).

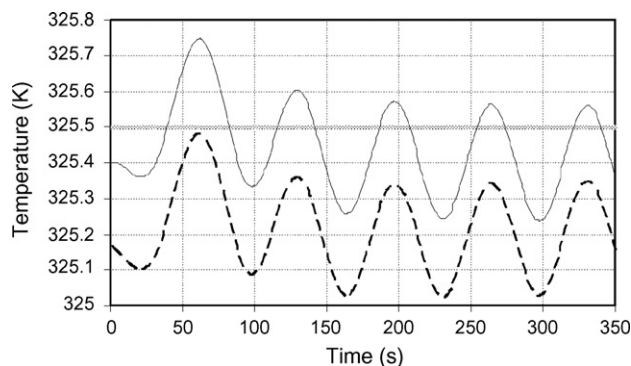

Fig. 9. Outlet temperature of the cooling water in the condenser: sequential approach (continuous line) and simultaneous approach (ragged line).

Fig. 9 shows the outlet water temperature for both the simultaneous and the sequential approaches. Considering the simultaneous approach (ragged line), one should note that the maximum temperature constraint is satisfied over the complete time horizon. Now let us consider the sequential approach (continuous line). If the maximum temperature constraint is included in the optimal control problem, no solution could be found: at the optimal control step of the sequential approach, the time invariant parameters, such as exchanger area, are fixed; for these values, there is no control policy that can satisfy the operating constraint. If the maximum temperature constraint is not included, as shown in Fig. 9, the constraint is violated.

4.3. Conclusion

The second example is much more challenging than the previous one: there are many more equations and variables; the model is much more complex (nonlinearity, rigorous thermodynamic models, etc.).

From the economical point of view, simultaneous and sequential results are very similar (Table 9). Actually, as in the previous heat exchanger simple example, the simultaneous approach is proved to be better from the operability point of view: the vapor velocity is lower than the maximum flooding velocity on the whole time interval. Using the sequential approach, flooding occurs!

Furthermore, if an additional constraint is introduced (maximum outlet temperature of the cold utility), there is no solution according to the sequential approach (the constraint has to be violated for the fixed values of the design parameters). Again the simultaneous approach is proved to be better since an optimal control policy is found.

5. General conclusions—future work

The emergence of the generic idea of optimality in the advanced methods of planning and implementation of complex interacting processes in chemical industry is probably one of the most important design principles in the past ten years. Uniquely amongst modern theories, optimal design and control can handle state, energy and actuator constraints in a straightforward

way, enabling plants to operate more closely to their ultimate profitable margins.

Initial research in the optimization of chemical processes focused mainly on the development of the process and control system design as independent sequential procedures. Recent results of research in this field have demonstrated that process and control design performed simultaneously may result in numerous economic benefits over the traditional sequential design approaches. In this paper the effects of the interaction of process and control design with special focus on the application of optimal control is investigated.

The basic contribution of this work is twofold. From the one hand, the application of the idea of optimal control in the process control design instead of the use of traditionally used PI controllers is a relatively new idea which has been considered in the chemical engineering practice quite lately. From the other hand, the simultaneous design, by merging process and control optimization into a single design phase, provides considerable operability benefits over traditional approaches.

The simultaneous approach, with the synergistic combination of the two optimization ideas integrates the design specifications of the process and control design problems into a single performance criterion. As a result, it fuses process and control optimization into a single design procedure in which the two optimization problems become closely coupled. With a simple illustrative example (coaxial heat exchanger), the effectiveness of the integrated design approach was demonstrated proving to achieve a better design both from economic and operability point of view. The integrated strategy was also successfully applied to a catalytic distillation process, which has a great industrial relevance in advanced petrochemical technologies, by showing how better operability can be achieved using the simultaneous approach.

In future works the introduction of discrete design variables and discrete control policy is to be considered. In order to improve the probability to find the exact global optimum, new global dynamic optimization techniques must be developed. Stochastic programming tools may be of great interest. Implementation of the optimal control policy is another challenging issue: optimization of the control loop structure and optimization of the controller parameters. Though the presented results are capable to handle process perturbations, process uncertainties are to be considered too: in this contribution, external disturbances are supposed to be known. Furthermore, in the considered examples, these perturbations are sinusoidal. For sake of generality, uncertain parameters are to be considered. Such parameters lie in a given interval and no specific models are required to describe the time dependence. Then a new solution strategy must be developed.

Nomenclature

A	heat transfer area (m^2)
B	bottom flow rate (mol/s)
c	cost coefficient
C	cost (\$)
C_p	specific heat capacity ($\text{J}/(\text{kg K})$)

d	design parameter
D_c	column diameter (m)
D_e	diameter of the outer tube (m)
D_i	diameter of the inner tube (m)
$f(\cdot)$	process model
f_c	friction factor
F_a	feed flow rate (mol/s)
F_c	material factor
F_{fac}	scale factor
F_w	water flow rate (mol/s)
$g(\cdot)$	operating cost (\$)
H	Hamiltonian
H_c	column height (ft)
ℓ	length (m)
M&S	Marshall and Swift index
nc	number of components
ne	number of trays of the column
np	number of discretization points
P	pressure (bar)
P_i	penalization cost
ΔP	pressure drop (Pa)
q	volumetric flowrate (m^3/s)
$q(\cdot)$	design constraints
Q_r	reboiler duty (kJ/s)
R	reflux ratio
S	terminal term of the operating cost (\$)
S_c	condenser area (m)
t	time (h, s)
T	temperature (K)
u	control variable
U	heat transfer coefficient ($\text{W}/(\text{m}^2 \text{K})$)
V	volume (m^3)
Ve	velocity (m/s)
x	state variable
x	molar composition (reactive distillation example)
z	feed molar composition

Greek letters

λ	co-state variable
ω	annualized investment cost (\$)
φ	Lagrange multiplier
ρ	density (kg/m^3)
θ	perturbed parameter
ξ	slack variable

Subscripts

c	cold
col	column
cond	condenser
f	final
h	hot
i	input
inv	investment
min	minimum
o	initial
o	output (heat exchanger example)
op	operating

tray tray

Superscripts

ref reference

* optimal

References

- [1] M.S. Söylemez, On the thermoeconomical optimization of heat pipe heat exchanger (HPHE) for waste heat recovery, *Energy Convers. Manage.* 44 (2003) 2509–2517.
- [2] I.E. Grossmann, R.W.H. Sargent, Optimal design of chemical plants with uncertain parameters, *J. Am. Inst. Chem. Eng.* 24 (1978) 1021–1028.
- [3] V. Bansal, R. Ross, J.D. Perkins, E.N. Pistikopoulos, The interactions of design and control: double-effect distillation, *J. Proc. Cont.* 10 (2000) 219–227.
- [4] R. Ross, J.D. Perkins, E.N. Pistikopoulos, G.L. Koot, J.M.G. van Schijndel, Optimal design and control of a high-purity industrial distillation system, *Comp. Chem. Eng.* 25 (2001) 141–150.
- [5] M.C. Georgiadis, M. Schenk, E.N. Pistikopoulos, R. Gani, The interactions of design, control and operability in reactive distillation systems, *Comp. Chem. Eng.* 26 (2002) 735–746.
- [6] V. Sakizlis, D. Perkins, N. Pistikopoulos, Simultaneous process and control design using mixed integer dynamic optimization and parametric programming, in: P. Seferlis, M.C. Georgiadis (Eds.), *The Integration of Process Design and Control*; Edited Computer Aided Chemical Engineering, vol. 17, 2004, pp. 187–215.
- [7] W. Luyben, The need for simultaneous design education, *Comp. Aided Chem. Eng.* 17 (2004) 10–41 (Special Issue on Integration of Process Design and Control).
- [8] J. Perkins, S. Walsh, Optimization as a tool for design/control integration, *Comp. Chem. Eng.* 20 (1996) 315–323.
- [9] J. Silverstein, R. Shinnar, Stability of reactors operating at an unstable steady state, in: *AIChE 70th Annual Meeting*, New York, 1977.
- [10] L.S. Pontryagin, V.G. Boltyanskii, R.V. Gamkrelidze, E.F. Mishchenko, *The Mathematical Theory of Optimal Processes*, John Wiley & Sons, 1962.
- [11] E. Kreindler, Additional necessary conditions for optimal control with state-variable inequality constraints, *J. Opt. Theory Appl.* 38 (1982) 241–250.
- [12] J.O. Taylor, Comments on a multiplier condition for problems with state variable inequality constraints, *IEEE Trans. Aut. Contr. AC-17* (5) (1972) 743–744.
- [13] M. Athans, P. Falb, *Optimal Control*, McGraw Hill, 1966.
- [14] J. Mohideen, J.D. Perkins, E.N. Pistikopoulos, Optimal design of dynamic systems under uncertainty, *AIChE J.* 42 (1996) 2251–2270.
- [15] J. Gmehling, J. Menke, J. Krafczyk, K. Fisher, *Azeotropic Data, Part I*, VCH, Weinheim, Germany, 1994.
- [16] Y. Zhang, K. Jensen, P. Kitchaiya, C. Phillips, R. Datta, Liquid-phase synthesis of ethanol-derived mixed tertiary alkyl ethyl ethers in an isothermal integral packed-bed reactor, *Ind. Eng. Chem. Res.* 36 (1997) 4586.
- [17] J.M. Douglas, *Conceptual design of chemical processes*, McGraw-Hill, Inc., 1988.
- [18] A.L. Lygeros, K.G. Magoulas, Column flooding and entrainment, *Hydrocarbon Process.* 65 (1986) 43–44.
- [19] C. Schmid, L.T. Biegler, Quadratic programming methods for reduced hessian SQP, *Comp. Chem. Eng.* 8 (1994) 817–832.