



HAL
open science

Morphing Wing Technologies within the Airgreen 2 Project

Ignazio Dimino, Frederic Moens, Rosario Pecora, Sergio Ricci, Salvatore Ameduri, Antonio Concilio, Umberto Mercurio, Giovanni Marco Carossa

► **To cite this version:**

Ignazio Dimino, Frederic Moens, Rosario Pecora, Sergio Ricci, Salvatore Ameduri, et al.. Morphing Wing Technologies within the Airgreen 2 Project. AIAA SCITECH 2022 Forum, Jan 2022, San Diego, United States. 10.2514/6.2022-0718 . hal-03579462

HAL Id: hal-03579462

<https://hal.science/hal-03579462>

Submitted on 18 Feb 2022

HAL is a multi-disciplinary open access archive for the deposit and dissemination of scientific research documents, whether they are published or not. The documents may come from teaching and research institutions in France or abroad, or from public or private research centers.

L'archive ouverte pluridisciplinaire **HAL**, est destinée au dépôt et à la diffusion de documents scientifiques de niveau recherche, publiés ou non, émanant des établissements d'enseignement et de recherche français ou étrangers, des laboratoires publics ou privés.

Morphing Wing Technologies within the Airgreen 2 Project

I. Dimino¹, F. Moens², R. Pecora³, S. Ricci⁴, S. Ameduri¹, A. Concilio¹, U. Mercurio¹, G. M. Carossa⁵

¹*Centro Italiano Ricerche Aerospaziali, Capua, Caserta, 81043, Italy*

²*The French Aerospace Lab, ONERA, 92190 Meudon, France*

³*Università degli Studi di Napoli “Federico II”, Napoli, 80125, Italy*

⁴*Politecnico di Milano, Milano, 20156, Italy*

⁵*Leonardo Aircraft Division, Torino, 10146, Italy*

This paper summarizes the results of the design study and provides a description of three morphing wing devices developed for a turboprop regional aircraft in the framework of the Clean Sky 2 REG-IADP Airgreen 2 project. In synergy with a natural laminar flow wing, morphing wing technologies are investigated to improve both high-lift performance and aerodynamic efficiency in off-design conditions of the aircraft, by demonstrating also load control and alleviation capabilities over the flight envelope. The combined use of a deformable droop nose and a multifunctional morphing flap, designed by PoliMi and UniNA respectively, is able to meet the minimum high-lift performance requirements of the AG2-NLF aircraft for both take-off and landing conditions. The controlled flap is deployed during take-off by using a fairingless mechanism, totally hosted in the wing that offers additional benefits on structural weight and aerodynamic efficiency at high speed. The flap camber is then morphed to gain the extra lift required for landing operations. An adaptive winglet concept, designed by CIRA, is also presented to further enhance aircraft aerodynamic efficiency also in climb/descent conditions by lowering at the same time wing-bending moments due to aircraft maneuvers. Such a mechanical system is characterized by two movable surfaces aimed at performing variable camber and differential tab settings depending on the flight conditions. Both aerodynamic performance and benefits of the three morphing devices are assessed by ONERA on the natural laminar flow wing.

Acronyms

IADP	Innovative Architecture Demonstrator Platform
FP7	Seventh Framework Programme
NLF	Natural Laminar Flow
AG2	Airgreen 2 project
GRA	Green Regional Aircraft
WATE	Winglet with an active trailing edge
C_L	Lift coefficient
C_D	Drag coefficient
LoD	Lift-to-Drag ratio
EMA	Electromechanical actuators

I. Introduction

In the framework of the Clean Sky 2 REG IADP currently running in Europe, advanced morphing wing technologies are being developed to optimise the wing's aerodynamic performance of a turboprop regional aircraft over the entire flight envelope. Due to the typical turboprop mission duration of one hour, the ascent/descent flight segments of such a class of aircraft usually take up a significant portion of the overall flight, with significant impact on fuel consumption and passengers' comfort. As a result, standard wing design optimization approaches based on weight and fuel consumption minimization may result in suboptimal wing designs that may result very sensitive to off-design or slightly changing conditions. Conversely, the use of morphing technology may provide efficient solutions to improve aircraft performance for these off design conditions (climb, high speed) or to extent its related flight domain (load and gust control).

Several studies may be found in the literature on aircraft morphing wing systems [1]-[4]. Morphing high lift devices have proven to enhance aircraft high-lift performance during take-off and landing by reducing friction drag and aerodynamic noise [3]. During high speed flight, the last portion of the flap may be also controlled to reduce the overall aerodynamic drag by reducing fuel consumption and emissions [4]. Also, integrated morphing flap deployment mechanisms lead to smaller flap fairings with additional benefits on structural weight and aerodynamic efficiency at high speed. NASA and Boeing adapted camber morphing wing concepts to Mission Adaptive Wing F111 program in the 1980's [5]-[6]. Similarly, a variable camber trailing edge device, developed within the EU FP7 SARISTU project [4], showed to provide significant fuel burn savings (about 6% or greater) for a medium range aircraft.

Both compliant and kinematic layouts are currently studied to implement the morphing wing capability. Compliant architectures rely on the controlled deformation of subcomponents to smoothly modify the overall shape of the assembly [7]-[9]. This requires tailoring the structural compliance to accommodate large deformations and provide enough robustness to preserve a given shape under external aerodynamic loads. Kinematic layouts are instead multi-hinge arrangements capable to provide shape adaptation of large aircraft lifting surfaces [10]-[12]. More specifically, the inner structure consists of a skeleton-like articulation of rigid components moving according to a specific mechanical law depending on the hinges and links positions; the activation of the mechanism is driven by load bearing actuator and a transmission line designed to withstand aerodynamic loads. Also, a morphing skin envelopes the skeleton to preserve the geometrical smoothness. De Gaspari [13] proposed a design of adaptive compliant droop nose through a multilevel optimization approach where structural, aerodynamic and topology optimization were adopted. Pecora et al. [14] developed a kinematic rib-based structural system to realize a shape changing wing trailing edge device. Dimino et al. [15] proposed a shape changing finger-like mechanism for the integrated design of a morphing winglet. An adaptive winglet device with a single active trailing edge (WATE) was also developed in the framework of the SARISTU project [16].

Under the industrial guidance of Leonardo Aerospace Division and coordinated by CIRA, the Airgreen 2 project aims at developing morphing wing devices to increase regional aircraft aerodynamic performance and reduce fuel burn through a combination of innovative aerodynamic, structural, and propulsive efficiency solutions [17]. Taking into account the outcomes of Clean Sky GRA [18], advanced researches are carried out in the frame of the WP 2.1.2 to improve the design of the next generation regional aircraft through a rational implementation of natural laminar flow and morphing wing technologies. In this work, the advanced design of three morphing concepts, i.e. a droop nose, a multifunctional flap and an adaptive winglet, is discussed for integration into the natural laminar flow wing. Aerodynamic performances are globally evaluated and preliminarily assessed against requirements. Final mechanical design of the morphing systems are described along with some key design aspects addressed during the course of the project. The morphing droop nose design is based on the synergic use of both compliant skin and internal compliant mechanism whereas both the multifunctional flap and the morphing winglet designs rely upon a "finger-like" architecture. The Airgreen 2 project is entering the final experimental technology demonstrators manufacturing phase and the ground test results will be disseminated in the coming months.

II. Reference Airgreen 2 Regional Aircraft

The baseline aircraft considered in the project is a 90-pax turboprop aircraft (Fig. 1) designed by Leonardo Company in the framework of CleanSky 1 GRA-ITD programme. In Clean Sky 2, such a reference aircraft wing was modified to incorporate novel morphing wing devices and flight demonstrate advanced aerodynamic and load control and alleviation solutions through a comprehensive set of full scale demonstrators.

The regional aircraft wing was redesigned by ONERA in order to have a satisfactory performance over the whole flight domain addressed by CS2 REG IADP, including cruise, low-speed and off-design conditions, by obtaining extensive natural laminar flow regions on suction and pressure sides of the wing. The aerodynamic flow around the 3D airplane configurations was predicted by the elsA CFD software [19] (ONERA-Airbus-Safran property).



Fig. 1. Reference TP90 aircraft [17] (© REG IADP Consortium Members).

A preliminary performance assessment was done at low speeds in two dimensional flow for a standard leading edge and flap combination. Considering the high level of performance required in take-off and landing conditions, the use of morphing technology was mandatory to improve the insufficient low speed performance of the NLF wing, originally optimized for high speed conditions. The combined advantage of providing the natural laminar flow wing with morphing capabilities was even greater because it enabled a robust aerodynamic design optimization including shape changing airfoils enhancing the maximum lift and stall angles at low speeds.

In a second design step, the reference aircraft natural laminar flow wing tips were modified in order to integrate two reference winglets without significantly affecting the NLF characteristics found on the wing-alone computations at high speeds. As a result, an extended laminar flow was obtained on about 50% of both the upper and lower surfaces, thus satisfying the aerodynamic design requirements. Fig. 2 shows the computed aerodynamic performance of the reference AG2 NLF wing at cruise conditions, for both turbulent and free transition.

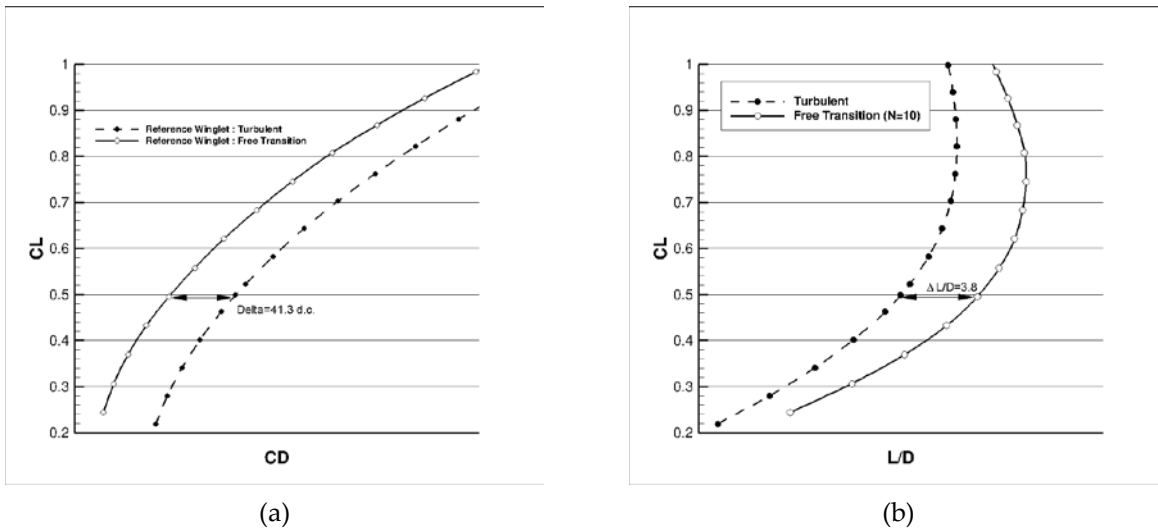

Fig. 2. AG2-NLF wing aerodynamic performance at cruise conditions [15] ($M = 0.52$ @ 20,000 ft): (a) Drag Polar ($CL(CD)$) curve; (b) $CL(CL/CD)$ curve.

The NLF technology allowed a global drag reduction of about 40d.c. at the flight C_L (0.50), without considering the nacelle and the propeller. Therefore, these values shall be dealt with as the upper limit in the performance improvement enabled by the NLF technology on the global aircraft.

III. Morphing Droop Nose

Once the NLF wing shape and the main geometrical constraints for flap design were defined, a morphing droop nose was designed to improve the high-lift performance of the AG2-NLF wing. Such a device is ideally suited for integration into a NLF wing that requires the continuity of the skin while minimizing, at the same time, drag at high speeds. Additionally, the higher levels of lift with relatively simpler operation of deployment mechanism allow to reduce the complexity of the flap track system, and hence structural weight of high lift systems for such class of aircraft.

The detailed design process of the droop nose adapted to the AG2-NLF wing is detailed in [20]-[22]. It involved advanced aero-structural optimizations carried out by Politecnico di Milano and aerodynamic performance assessments done by ONERA.

Starting from the NLF wing geometry, the morphing shape optimization process was run using two objective functions combining the minimization of the aerodynamic drag coefficient in high-lift conditions and the maximization of the leading edge deflection, under structural constraints limiting bending and axial stresses inside the morphing skin. Such a methodology was presented in [22]- [23] leading to successful results.

Such an integrated approach, where both aerodynamic and structural constraints were simultaneously considered, resulted in a set of optimized droop nose shapes, shown in Fig. 3, that were assessed by ONERA through 3D CFD evaluations. By using a simpler deployment mechanism, the deployment strategy considered first to move the flap to its take-off settings. In that condition, the droop nose reduced significantly the suction peak at leading edge, which makes the pressure gradient less favorable for a stall occurrence that was observed at higher incidence, see Fig. 4.

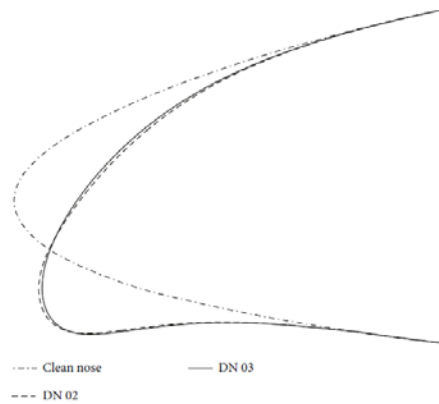

Fig. 3. Comparison of droop nose shapes at the wing outboard section [20].

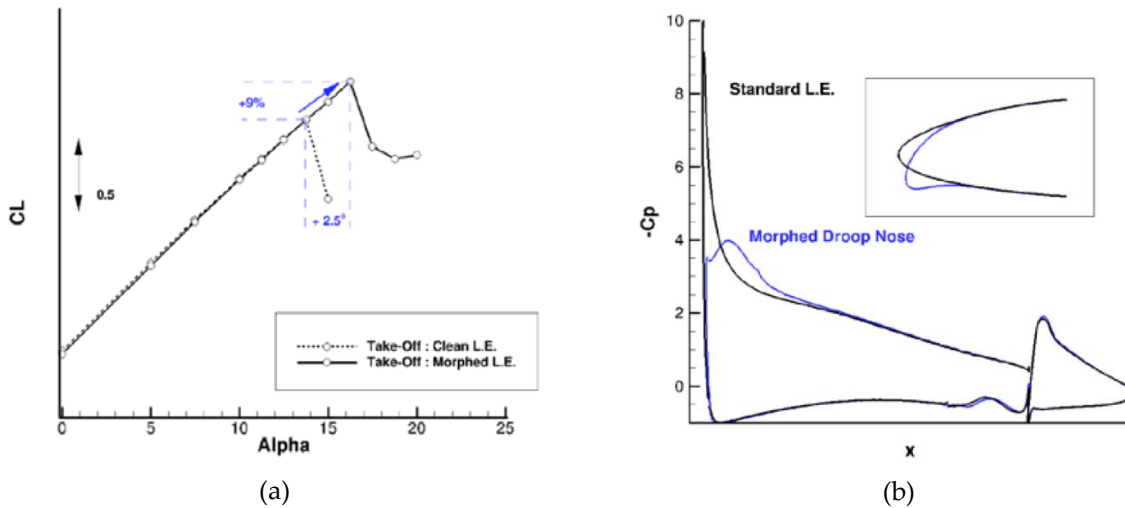

Fig. 4. Effect of a droop nose on (a) take-off performance; (b) pressure distribution at the outboard flap section (Take-off conditions: $M=0.20$, Altitude=0 ft, $\alpha=12.5\text{deg}$) [24].

Then, the flap shape was morphed to reach the maximum C_L during landing requirements of aircraft. For this reason, improvements in aircraft fuel consumption were demonstrated at the high-speed phase of the flight by finding a more favourable balance between increased wing area and smaller flap fairings and weight. This in turn had beneficial effect on efficiency and reliability of the high-lift system by influencing also aircraft operation and maintenance costs.

Once the target morphing shapes were defined, the design of a fully compliant mechanism was performed using a dedicated code named SPHERA (PoliMI proprietary) [20]. The structure consists of the skin and internal compliant

ribs that, once actuated, force the skin to assume the target shape already optimized for aerodynamic purpose. Firstly, the skin was optimized by assuming a variable thickness distribution. After that, optimal compliant ribs were optimized in 2D and packed together with the skin into a single fully compliant 3D model for the final refinement.

The final compliant architecture was able to meet both kinematic (motion) and structural (load-carrying) requirements, considering the mechanism design and the structure design, respectively, for a number of load conditions corresponding to the analyzed aerodynamic conditions. Starting from 2D compliant solutions, medium-fidelity 3D non-linear analyses were firstly performed in full-span configuration. The undeformed and deformed models of the final 3D architecture are shown in. The maximum strain is close to the skin structural constraints imposed in the aerodynamic optimization.

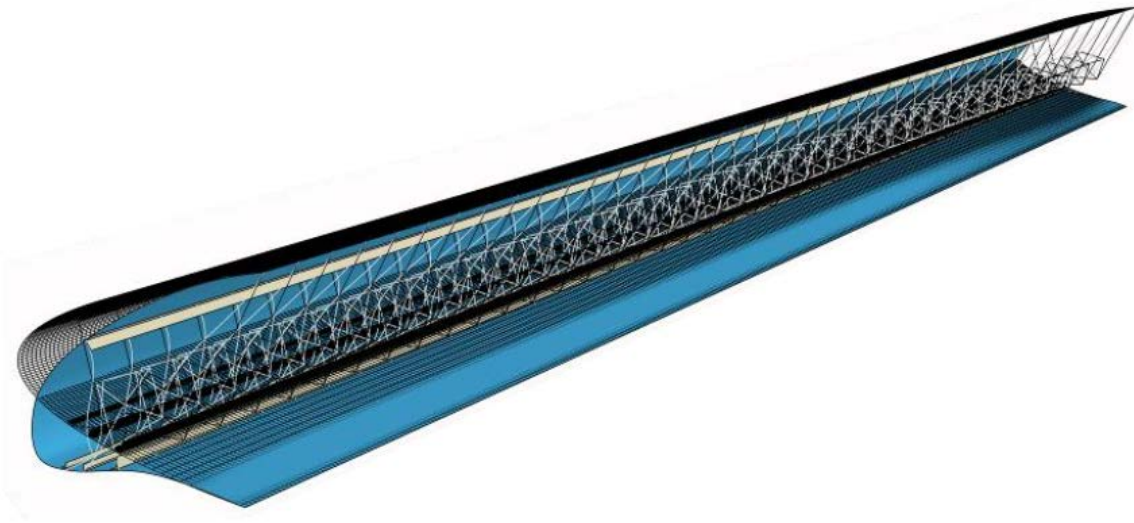

Fig. 5. Final 3D droop nose designed by PoliMi [22].

IV. Multifunctional Flap

The design of a novel morphing flap architecture enabling the multimodal camber morphing of the reference AG2 regional aircraft wing flap was addressed by University of Naples. The flap is characterized by three different morphing modes, shown in Fig. 6, that are activated depending on the flight conditions.

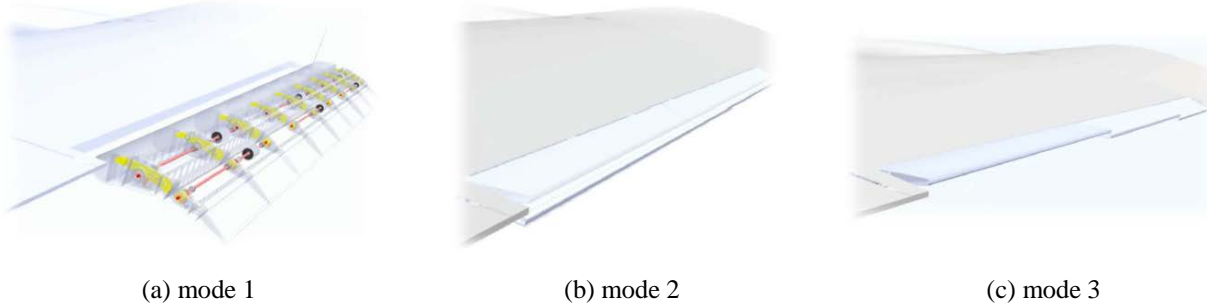

Fig. 6. Morphing Flap modes: (a) high-lift; (b) high speed tab; (c) high speed twist [25].

The flap is mounted on aircraft wing using a simple and fully integrated tracking mechanism, designed by Siemens [26], that can be deployed during takeoff and landing conditions. The deployment mechanism, totally hosted in the wing, is optimized to set the flap at the optimal take-off configuration (mode 1). During the approach to the ground, the flap camber is then morphed to gain the extra lift required for landing operations, without using a fairing for deployment. The resulting kinematics is thus less complex, light weight and reduces drag and fuel burn at high speeds. The deployment settings at the trailing edge are shown in Fig. 7.



Fig. 7. Morphing flap deployment (mode 1): (a) Tracking system; (b) Take-off and landing settings [24].

From Fig. 8 the contribution to lift augmentation at a given angle of attack is significant since the combination of droop nose and morphing flap remarkably increases the maximum C_L . For landing configuration, the use of the morphing droop nose increases the stall angle of about 5° and it seems absolutely necessary to guarantee the minimum lift coefficient that meets the performance requirements of the AG2-NLF aircraft. It is worth noting that such a requirement is not reached for the configuration equipped with a standard leading-edge.

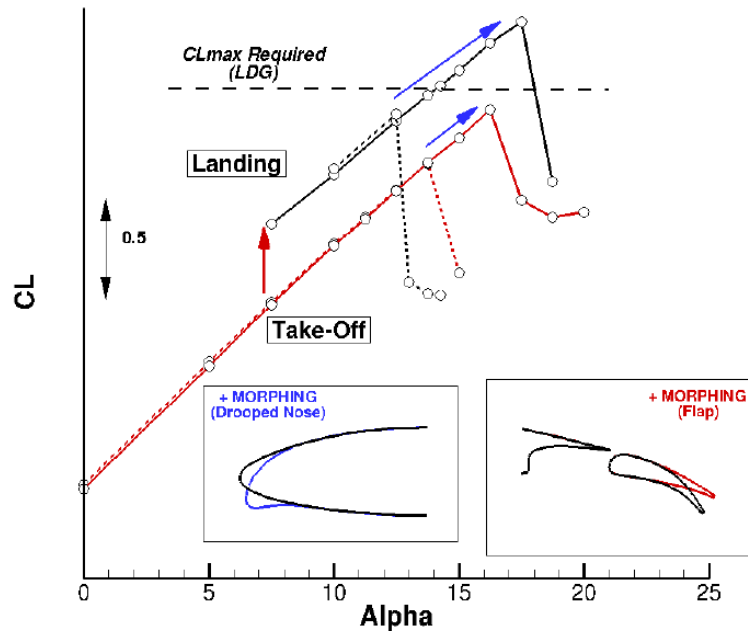

Fig. 8. High lift performance of the AG2-NLF equipped with droop nose and morphing flap (Landing : $M=0.15$, Altitude=0ft - Take-Off : $M=0.20$, Altitude=0 ft. [24].

In high speed conditions, when the flap is stowed, the last 10% of the flap chord can be synchronously moved upwards and downwards (mode 2) to control load distribution along the wing span in the attempt to increase wing efficiency in off-design conditions and potentially reduce gusts loads. The maximum deflection of the flap tab is 10° . Also, to perform load alleviation functions, the last portion of the flap can be equivalently twisted by controlling the differential deflection of three tabs located on the trailing edge of the flap (max upwards/downwards deflection: 10°).

For the AG2 NLF regional wing, free transition computations at off-design conditions with high C_L values (climb condition) showed that the laminar flow on the upper surface started to be lost on the outer wing. In order to improve the aerodynamic efficiency, it was then investigated the possibility to activate mode 2 and 3 of the multifunctional flap. Different tab deflections were then evaluated and the resulting lift over drag ratio (LoD) is shown in Fig. 9. The black curve corresponds to the aerodynamic performance of the reference wing. A loss of performance is observed at high C_L values due to the loss of laminarity. However, very small deflections of the multifunctional flap at high

speeds allowed to increase the LoD curve, with a global improvement on the order of 2%. Such an improvement was observed for deflections up to 5 deg and it vanished at higher deflection angles.

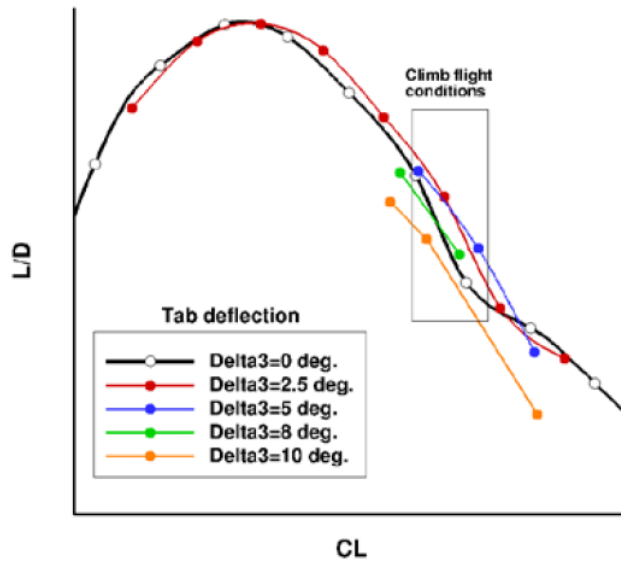

Fig. 9. LoD performance of the multi functional trailing edge flap in off-design conditions [24].

The structural architecture of the multifunctional flap is based on a multi-box arrangement characterized by articulated finger-like ribs [14]. Each finger-like rib consists of four consecutive blocks (B0, B1, B2, B3) connected to each other by hinges (A, B, C) located on the airfoil camber line, as shown in Fig. 10. The resulting mechanism is then forced to rotate according to specific gear ratio depending on the position of the linking beams (L) connecting the not adjacent blocks B0 and B2. An inner leverage (M1), moved by an external rotary actuator acting along the shaft (R1), drives the relative rotation of block B2 with respect to block B1. A secondary leverage (M2), hosted by rib block (B2), allows the rotation of block B3 around the hinge C to enable the tab-like motion required by morphing modes 2 and 3. Both leverages (M1, M2) are activated to replicate the target morphed shape required in high-lift conditions (mode 1). When morphing modes 2 and 3 are activated, the first leverage (M1) is locked and only the second one (M2) is activated to deflect the tab.

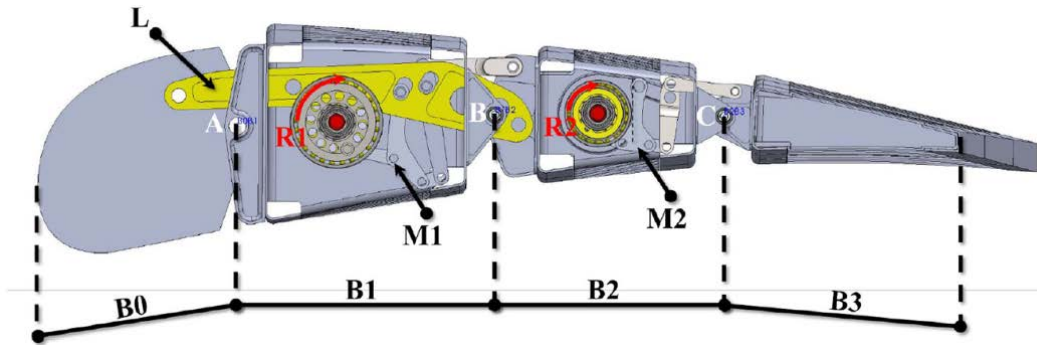

Fig. 10. Finger-like morphing rib and embedded mechanisms [25].

The motion of the entire flap is controlled by six actuators and the same number of transmission lines. The actuation arrangement of the last two bays is shown in Fig. 11. Both actuators are activated to enable the camber morphing at low speeds. At high speeds only the rear line of actuators is activated to deflect the three tab segments (in a conformal or differential manner). Such a structural architecture was proven to withstand limit loads expected in service without permanent deformations, failures or buckling [27]. A full-scale demonstrator having a limited span of about 5 meters is planned to be manufactured and validated through ground tests. Both static and dynamic tests will be carried out to validate the actual design, by measuring the most stressed regions, the modal properties and the deviation between the actual and the predicted shapes of the device under the operational loads.

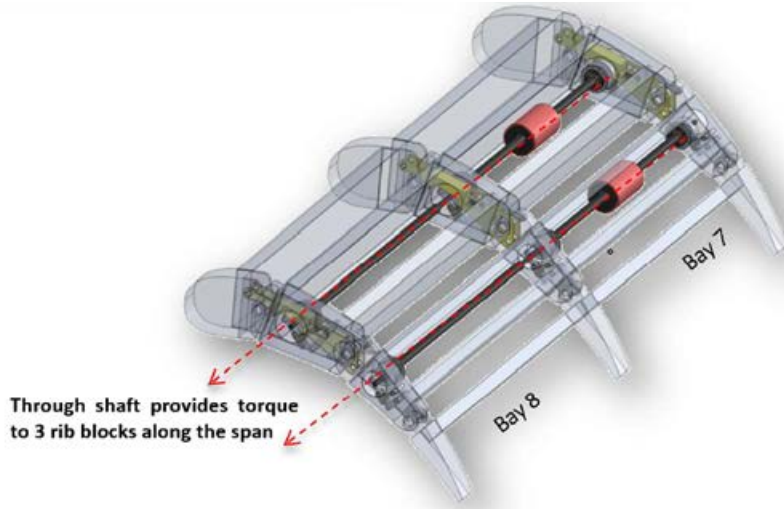

Fig. 11. Detail of the last two bays mechanism [25].

V. Adaptive Winglet

A fault-tolerant adaptive winglet concept based on two individual (asynchronous) morphing surfaces was developed by CIRA in order to enhance wing aerodynamic efficiency in off-design conditions and reduce maneuver loads on the reference AG2 regional aircraft. The integrated design of the adaptive winglet is detailed in [15].

The adaptive winglet consists of two “finger-like” mechanisms, shown in Fig. 12, driving the same number of moveable surfaces (the upper and lower tabs), controlled by dedicated electromechanical actuators [29]. Each mechanical system, having two separate hinge lines enabling the camber morphing of the two devices either synchronously or independently, was successfully validated on both full-scale morphing wing trailing edge [12],[14] and aileron demonstrators [30]-[32].

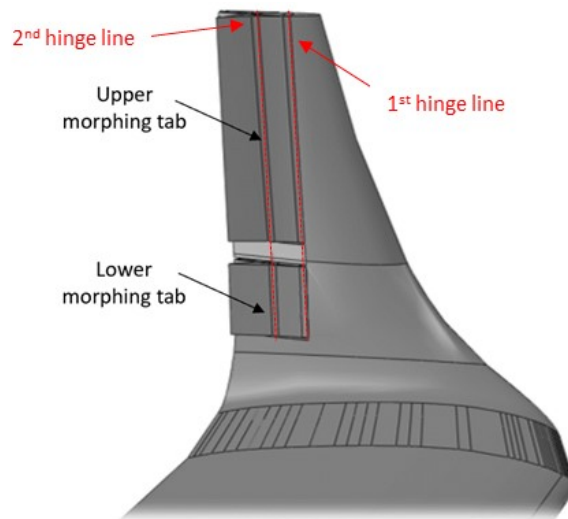

Fig. 12. Sketch of the morphing winglet [28].

High fidelity CFD analyses were carried out by ONERA to investigate the potential of using morphing winglets to enhance wing aerodynamic efficiency. In a first step, a comparison with the reference counterpart was carried out at both cruise and climb conditions, when no morphing function was enabled, see Fig. 13. A slight improvement in the C_D (or LoD) was observed by comparing the green (turbulent) and blue (laminar) curves for the new winglet with the black (turbulent) and red (laminar) curves for the reference one. Performances were also estimated in climb conditions with similar results.

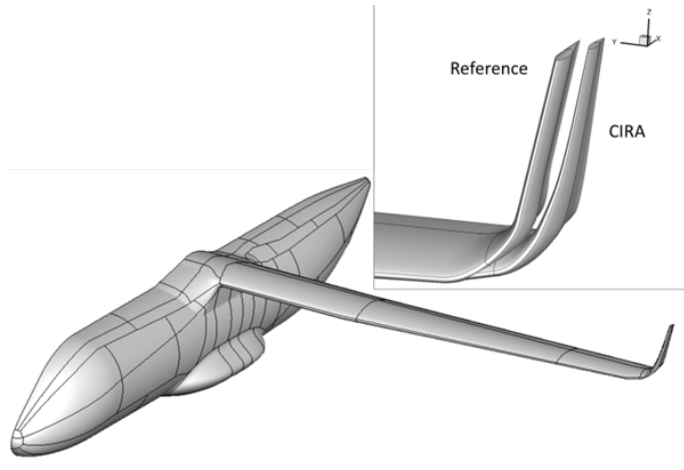

Fig. 13. Comparison of reference and CIRA winglet aeroshapes [15].

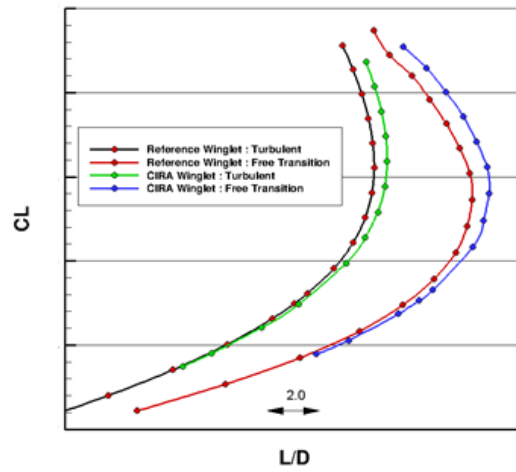

Fig. 14. Aerodynamic performance at cruise conditions ($M = 0.52 @ 20,000 \text{ ft}$) [15].

After that, the activation of the morphing tabs was evaluated by CFD simulations of the morphing winglet aeroshapes. The adopted convention considers a positive deflection when the tabs move outward. Also, the same deflection was considered for both the upper and lower tabs. Fig. 15 shows an example of morphing winglet tabs deflection of 10 deg.

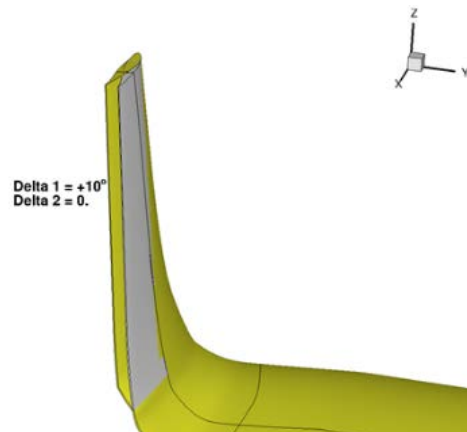

Fig. 15. Example of morphing winglet tabs deployment [15].

In terms of aerodynamic improvements at the design flight point, a very limited gain was observed at cruise conditions for small positive deflections. Higher LoD was found in climb conditions although the plain rotations at the first and second hinge lines of the tabs underestimated the morphing benefits. For more details, the reader may refer to [15].

The structural layout of the morphing winglet incorporates both a passive and an active part. The former consists of a torsion box made of spars and ribs, whereas the active tabs are deployed by two independent “finger-like” morphing mechanisms. Fig. 16 shows the morphing mechanism developed for the upper winglet tab. Each tab is a single-degree-of-freedom system where the individual rigid blocks rotate according to a specific gear ratio. The first block is connected to the rear spar of the winglet box and makes the so-called “dead box”. Camber morphing is enabled by the relative rotations of the consecutive segments, according to a specific gear ratio depending on the hinge and linking rods positions.

The actuation chain is completely embedded into the main body of the winglet. Due to the limited space available within the winglet box, both actuators and actuation mechanism were optimized to achieve the best compromise between motion amplification and load capacity. Two linear electromechanical actuators, one for each tab, are envisaged to drive the two independent surfaces. Such flight-worthy actuators of adequate size, weight, and power are being developed within the CS2 programme to withstand the hinge moments due to the aerodynamic loads [29].

The full-scale demonstrator of the adaptive winglet was manufactured and ground tested in July 2021. Such a test campaign proved the ability of the winglet to withstand the limit loads without detrimental permanent deformation. Functional tests were also carried out to demonstrate the actual capability of the actuation chain to replicate the target aerodynamic shapes with and without the effect of aerodynamic loads.

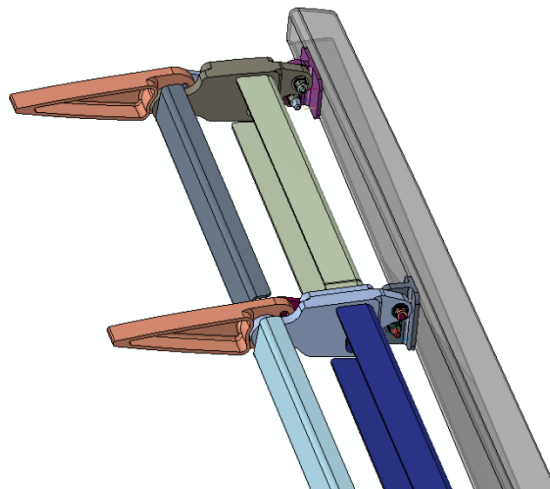

Fig. 16. Finger-like mechanism of the upper morphing tab of the winglet [15].

VI. Conclusions and further steps

In the framework of the Clean Sky 2 Regional Aircraft IADP, morphing wing technology is being extensively addressed for integration onboard innovative turboprop regional aircraft equipped with a natural laminar flow wing. The present work describes the key design aspects and the most significant aerodynamic simulation results achieved by three morphing devices developed within the Airgreen 2 project: a droop nose, a multifunctional flap and an adaptive winglet. The primary motivation for developing such technologies for regional aircraft is the potential to increase both high-lift performance and aerodynamic efficiency in cruise and off-design conditions (such as climb and descent) by implementing novel morphing wing concepts in combination with advanced aerodynamics, including natural laminar flow technology. The associated design strategies are planned to be validated by full-scale tests on high TRL demonstrators both on-the-ground and in-flight.

The reference regional turboprop aircraft as well as the initial global requirements and the design and optimization steps of the developed morphing wing devices are described in detail. A special emphasis is given to the aerodynamic benefits achieved by the synergic design of the morphing droop nose and multifunctional flap as well as the enhanced high speed load control and aerodynamic efficiency related to the use of the proposed adaptive winglet.

The use of a morphing droop nose, designed by PoliMi, preserves the surface quality of the natural laminar flow wing when retracted in cruise conditions. Also, the multifunctional flap, designed by UniNA, requires smaller flap fairings and a simpler deployment mechanism to reach the high level of performance required in take-off and landing conditions. Their combination increases both CL_{max} and stall angle and minimises drag at high speed. This in turn has a positive effect on aircraft fuel consumption and operational costs.

The use of an adaptive winglet, designed by CIRA, has shown to improve the aerodynamic performance during off-design conditions by providing optimal wing lift distribution throughout the A/C flight envelope. Additionally, in combination with the high speed capabilities of a multifunctional flap, they can contribute to significantly reduce aerodynamic loads at critical flight points by controlling the shape changing tabs.

Although the results reported in this paper are focused on the aerodynamic simulation results, the structural layout of the developed devices is also discussed. The assessment of the aeroelastic impacts induced by such movables on the dynamic stability of the aircraft is considered mandatory to consolidate a safe and robust design of the morphing devices. Then further design loops would require considering the propulsion system (nacelle, engines and propellers), the aircraft control surfaces (ailerons, horizontal tail, fin) and the flight control actuation system for a more accurate prediction of the aircraft performance over the entire operation flight envelope, both in nominal conditions and in case of failures or malfunction (free-plays) of tabs' control lines.

Acknowledgments

This work was funded by Clean Sky 2 Joint Undertaking, under the European's Union Horizon 2020 research and innovation Programme, under grant agreement No 807089 – REG GAM 2018 – H2020-IBA-CS2- GAMS-2017.

References

- [1] Kudva, J.N. Overview of the DARPA smart wing project. *J. Intell. Mater. Syst. Struct.* 2004, 15, 261–267.
- [2] NASA; US AFRL. Adaptive Compliant Trailing Edge Flight Experiment; RC Soaring Digest: Olalla, WA, USA, 2014; Volume 31, pp. 85–86.
- [3] Concilio, A.; Dimino, I.; Lecce, L.; Pecora, R. *Morphing Wing Technologies. Large Commercial Aircraft and Civil Helicopters*; Butterworth-Heinemann: Oxford, UK, 2018.
- [4] Wölcken, P.; Papadopoulos, M. (Eds.) *Smart Intelligent Aircraft Structures (SARISTU): Proceedings of the Final Project Conference*; Springer: Berlin/Heidelberg, Germany, 2016.
- [5] K. L. Bonnema, "AFTI/F-111 Mission Adaptive Wing Briefing to Industry," AFWAL Technical Report, Oct. 1988.
- [6] L. D. Webb, W. E. McCain, and I. A. Rose, "Measured and Predicted Pressure Distributions on the AFTI-F-111 Mission Adaptive Wing," in *NASA Technical Memorandum TM-100443*, National Aeronautics and Space Administration, Edwards, Ed. 1988.
- [7] Jensen, P.D.L.; Wang, F.; Dimino, I.; Sigmund, O. Topology Optimization of Large-Scale 3D Morphing Wingstructures. Preprints 2021, 2021070051 (doi: 10.20944/preprints202107.0051.v1).
- [8] Kambayashi, K.; Kogiso, N.; Yamada, T.; Izui, K.; Nishiwaki, S.; Tamayama, M. Multiobjective Topology Optimization for a Multi-layered Morphing Flap Considering Multiple Flight Conditions. *Transactions of the Japan Society for Aeronautical and Space Sciences* 2020, 63, 90–100. doi:10.2322/tjsass.63.90.
- [9] Tong, X.; Ge, W.; Yuan, Z.; Gao, D.; Gao, X. Integrated design of topology and material for composite morphing trailing edge based compliant mechanism. *Chinese Journal of Aeronautics* 2021, 34, 331–340. doi:10.1016/j.cja.2020.07.041.
- [10] Dimino, I.; Amendola, G.; Pecora, R.; Concilio, A.; Grati, A. and Schueller, M., Chapter 22 - On the Experimental Characterization of Morphing Structures, in *Morphing Wing Technologies*, A. Concilio, I. Dimino, L. Lecce, and R. Pecora, Eds. Butterworth-Heinemann, 2018, pp. 683–712.
- [11] Arena, M.; Amoroso, F.; Pecora, R.; Amendola, G.; Dimino, I.; Concilio, A. Numerical and experimental validation of a full scale servo-actuated morphing aileron model. *Smart Materials and Structures* 2018, 27, 105034. doi:10.1088/1361-665x/aad7d9.
- [12] Concilio, A.; Dimino, I.; Pecora, R. SARISTU: Adaptive Trailing Edge Device (ATED) design process review. *Chinese Journal of Aeronautics* 2020.
- [13] De Gaspari, A. Multiobjective Optimization for the Aero-Structural Design of Adaptive Compliant Wing Devices. *Applied Sciences* 2020, 10, 6380. doi:10.3390/app10186380.
- [14] R. Pecora, F. Amoroso, M. Magnifico, I. Dimino, and A. Concilio, "KRISTINA: Kinematic rib-based structural system for innovative adaptive trailing edge," in *Industrial and Commercial Applications of Smart Structures Technologies 2016*, Apr. 2016, vol. 9801, p. 980107, doi: 10.1117/12.2218516.
- [15] Dimino, I.; Andreutti, G.; Moens, F.; Fonte, F.; Pecora, R.; others. Integrated Design of a Morphing Winglet for Active Load Control and Alleviation of Turboprop Regional Aircraft. *Applied Sciences* 2021, 11, 2439.
- [16] Wildschek, S. Storm, M. Herring, D. Drezga, V. Korian, O. Roock, Design, Optimization, Testing, Verification, and Validation of the Wingtip Active Trailing Edge, *Smart Intelligent Aircraft Structures (SARISTU)*, pp 219-255.
- [17] Regional Aircraft Innovation Takes a Great Leap Forward. Available online: <https://cordis.europa.eu/article/id/422623-regional-aircraft-innovation-takes-a-great-leap-forward> (accessed on August 26th 2021).

- [18] Clean Sky's Morphing Wing project brings shape-shifting capabilities to European regional aircraft. Available online: <https://www.cleansky.eu/clean-skys-morphing-wing-project-brings-shape-shifting-capabilities-to-european-regional-aircraft> (accessed on August 26th 2021).
- [19] Cambier, L.; Heib, S.; Plot, S. The Onera elsA CFD Software: Input from Research and Feedback from Industry. *Mech. Ind.* 2013, 14, 159–174.
- [20] A. De Gaspari, F. Moens: Aerodynamic Shape Design and Validation of an Advanced High-Lift Device for a Regional Aircraft with Morphing Droop Nose. *Hindawi, International Journal of Aerospace Engineering*, 2019: <https://doi.org/10.1155/2019/7982168>.
- [21] A. De Gaspari, A. Gilardelli, S. Ricci, A. Airoidi, F. Moens: Design of a Leading Edge Morphing Based on Compliant Structures for a Twin-Prop Regional Aircraft. 2018 AIAA/AHS Adaptive Structure Conference, Kissimmee, Florida, AIAA 2018-1063.
- [22] A. De Gaspari, A. Gilardelli, S. Ricci, A. Airoidi, F. Moens: Design of a Leading Edge Morphing Based on Compliant Structures in the Framework of the CD2-Airgreen2 Project. SMASIS 2018 548 Conference, September 10-12 2018, San Antonio, Texas (USA).
- [23] F. Moens, J. Perraud, A. Krumbein, T. Toulorge, P. Iannelli, A. Hanifi: Transition Prediction and Impact on 3D High-Lift Wing Configuration. AIAA-2007-4302, 25th AIAA Applied Aerodynamics Conference. Miami (Florida). 25-28 June 2007.
- [24] Moens, F. Augmented Aircraft Performance with the Use of Morphing Technology for a Turboprop Regional Aircraft Wing. *Biomimetics* 2019, 4, 64.
- [25] Pecora R.; Amoroso F.; Dimino I. and Concilio A. Flutter analysis of a large civil aircraft in case of free-plays and internal failures of morphing wing flaps mechanical systems, *Proc. SPIE 10967, Active and Passive Smart Structures and Integrated Systems XIII*, 109670Y (21 March 2019); <https://doi.org/10.1117/12.2514251>.
- [26] A.E. Öngüt A, Y. Lemmens: A Simulation Methodology for the Design of Trailing-Edge Flap Deployment Mechanism. *NAFEMS Americas (CAASE)*, Cleveland, June 2018
- [27] Pecora, R., Amoroso, F., and Magnifico, M., "Toward the bi-modal camber morphing of large aircraft wing flaps: The CleanSky experience," in *Proceedings of SPIE - The International Society for Optical Engineering*, 2016, vol. 9801.
- [28] Noviello, M.C.; Dimino, I.; Concilio, A.; Amoroso, F.; Pecora, R. Aeroelastic Assessments and Functional Hazard Analysis of a Regional Aircraft Equipped with Morphing Winglets. *Aerospace* 2019, 6, 104.
- [29] Dimino, I.; Gallorini, F.; Palmieri, M.; Pispola, G. Electromechanical Actuation for Morphing Winglets. *Actuators* 2019, 8, 42.
- [30] Amendola, G.; Dimino, I.; Concilio, A.; Magnifico, M.; Pecora, R. Numerical design of an adaptive aileron. In *Proceedings of the SPIE—The International Society for Optical Engineering*, Las Vegas, NV, USA, 20–24 March 2016; Volume 9803, p. 98032.
- [31] Amendola, G.; Dimino, I.; Concilio, A.; Amoroso, F.; Pecora, R. Preliminary design of an adaptive aileron for the next generation regional aircraft. *J. Theor. Appl. Mech.* 2017, 55, 307–316.
- [32] Amendola, G.; Dimino, I.; Concilio, A.; Pecora, R.; Amoroso, F.; Lecce, L. Technological demonstration of an adaptive aileron system. In *Proceedings of the SPIE 10593, Bioinspiration, Biomimetics, and Bioreplication VIII*, Denver, CO, USA, 27 March 2018; p. 1059304.