



HAL
open science

Shewanella woodyi MS32: A new luminescent biosensor able to detect C8-AHL

Mahmoud Hayek, Claudine Baraquet, Yves Blache, Maëlle Molmeret

► **To cite this version:**

Mahmoud Hayek, Claudine Baraquet, Yves Blache, Maëlle Molmeret. Shewanella woodyi MS32: A new luminescent biosensor able to detect C8-AHL. FEMS, Jul 2017, Valencia, Spain. hal-03566501

HAL Id: hal-03566501

<https://hal.science/hal-03566501v1>

Submitted on 11 Feb 2022

HAL is a multi-disciplinary open access archive for the deposit and dissemination of scientific research documents, whether they are published or not. The documents may come from teaching and research institutions in France or abroad, or from public or private research centers.

L'archive ouverte pluridisciplinaire **HAL**, est destinée au dépôt et à la diffusion de documents scientifiques de niveau recherche, publiés ou non, émanant des établissements d'enseignement et de recherche français ou étrangers, des laboratoires publics ou privés.

Shewanella woodyi MS32: A new luminescent biosensor able to detect C8-AHL

Mahmoud HAYEK, Claudine BARAQUET, Yves BLACHE and Maëlle MOLMERET

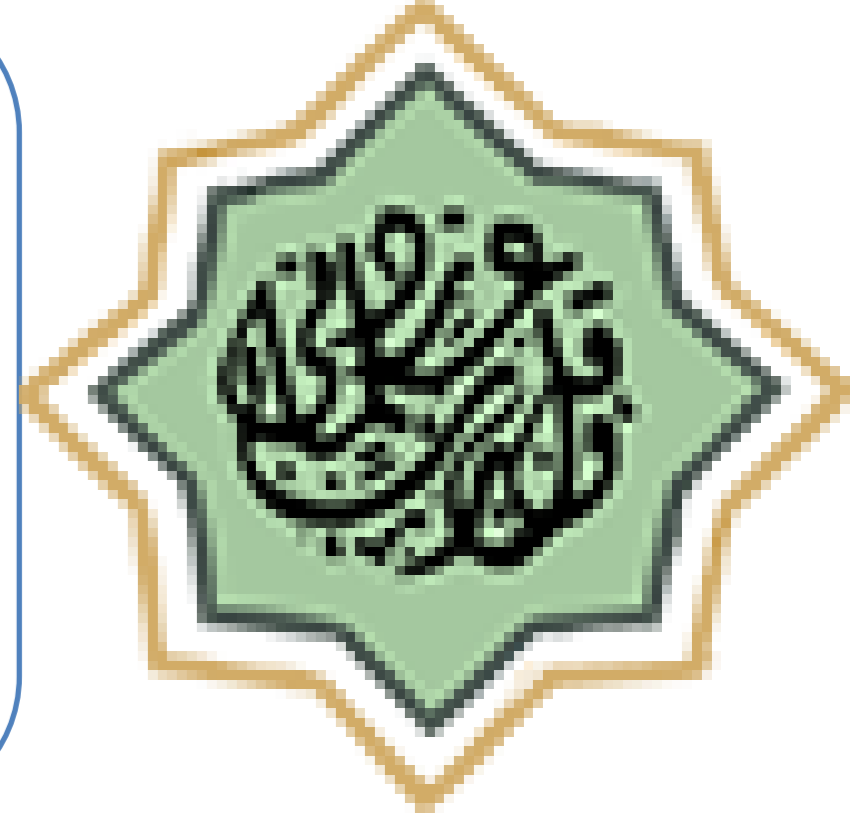

Abstract

Quorum sensing (QS) or cell-to-cell communication is a process by which bacteria produce and detect signal molecules and thereby coordinate their behavior in a cell-density dependent manner. The sequenced genome of the marine bioluminescent strain *S. woodyi* MS32 contains genes coding for the AHL QS system. The goal of this study is to identify the AHL QS communication system present in this bacterium and to understand its role in biofilm formation. The objective is also to develop a new marine QS biosensor from this strain.

By coupling bacterial biosensor assays and high resolution liquid chromatography mass spectrometry (LCMS), we showed that *S. woodyi* synthesized N-octanoyl-L-homoserine lactone (C8-AHL). We studied the effect of a wide range of AHLs on the *S. woodyi* luminescence and only C8-AHL molecule induces luminescence.

A mutation of the AHL system genes, the *luxI* synthase or the *luxR* receptor makes *S. woodyi* non-luminescent but surprisingly *S. woodyi* mutant and wild type have the same adhesion and biofilm formation pattern. On the other hand, the QS mutation reduces phagocytosis of *S. woodyi* by amoeba eukaryotic cells.

Introduction

Bacterial communication by AHL quorum sensing

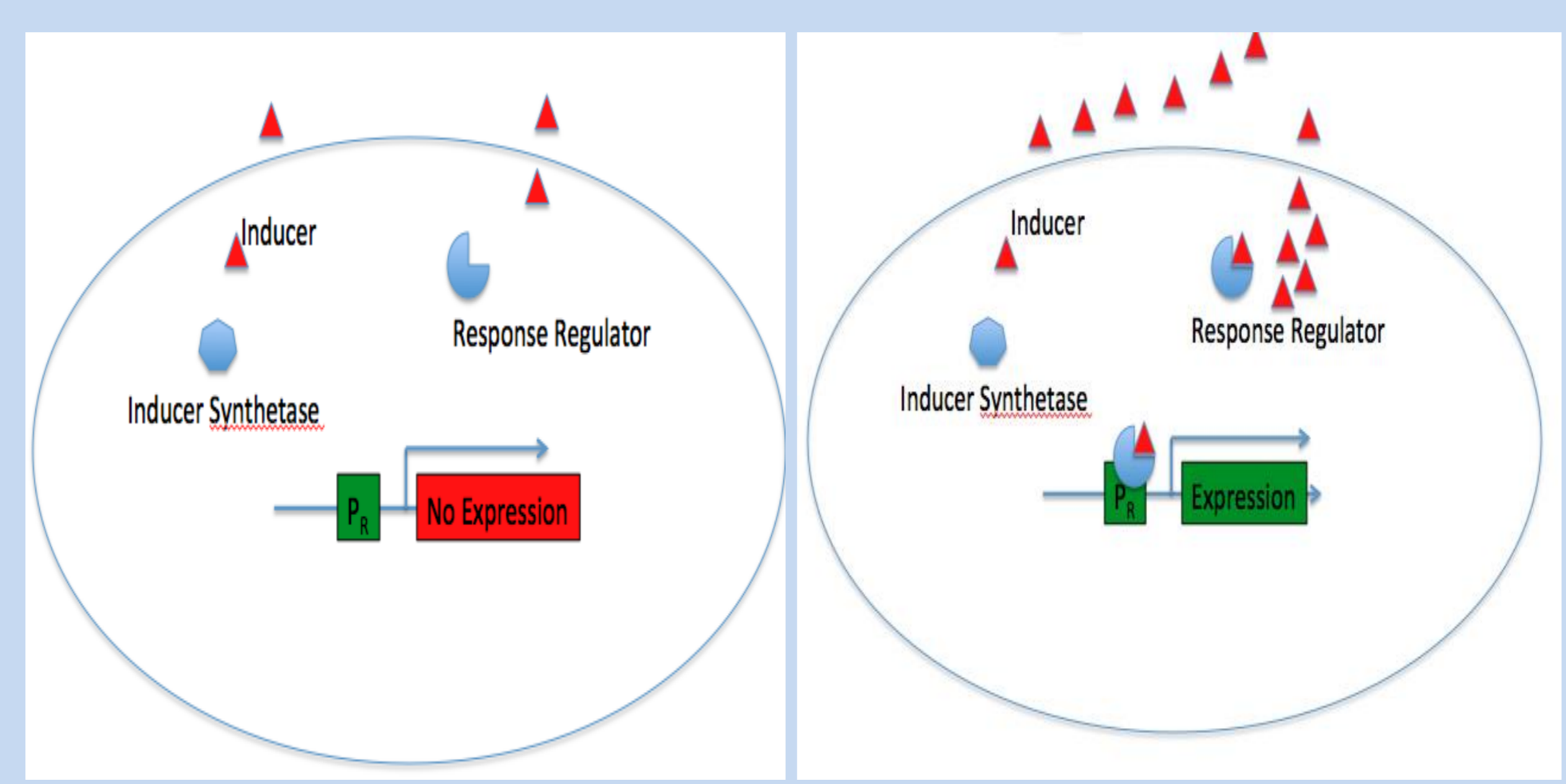

Low cell density

High cell density

Shewanella woodyi MS32

Gram-negative marine bacteria
Luminescent
Single polar flagellum
Biofilm formation

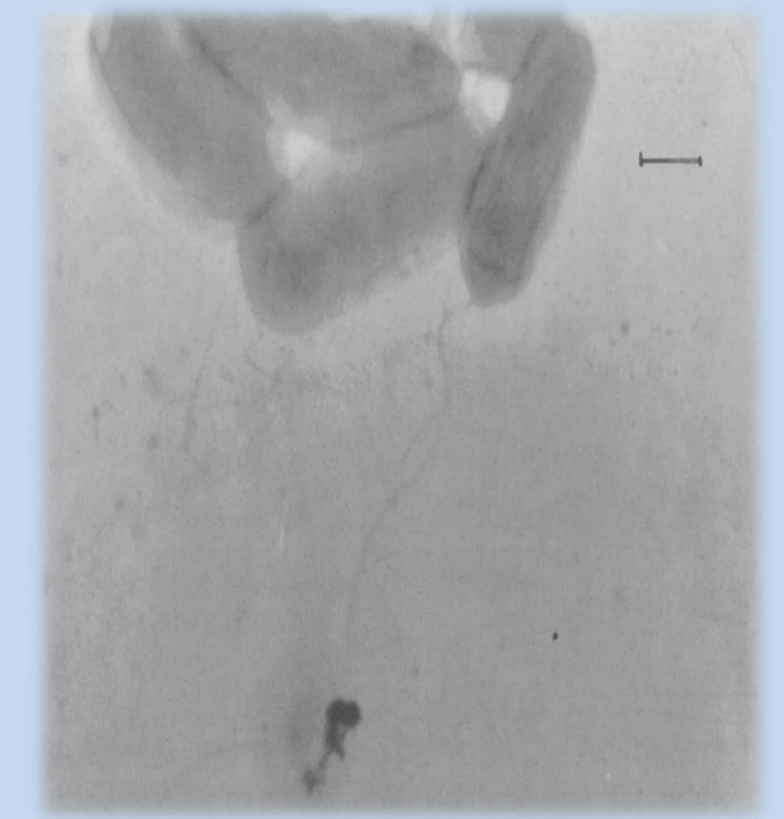

Quorum sensing genes:
luxI (Swoo_2998)
luxR (Swoo_2997)

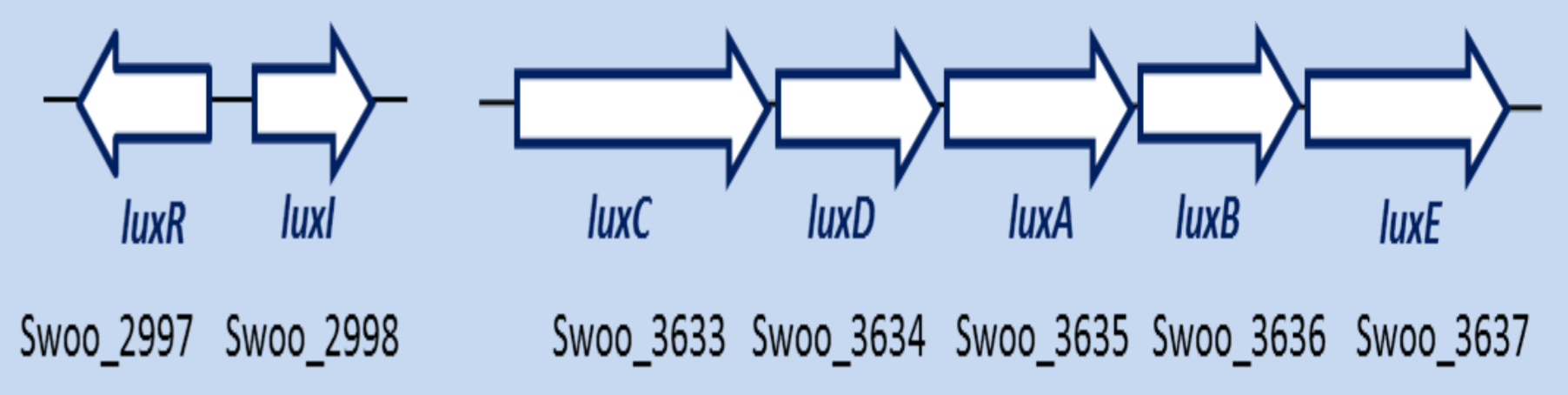

S. woodyi is a luminescent strain

Luminescence of *S. woodyi* is directly correlated with growth

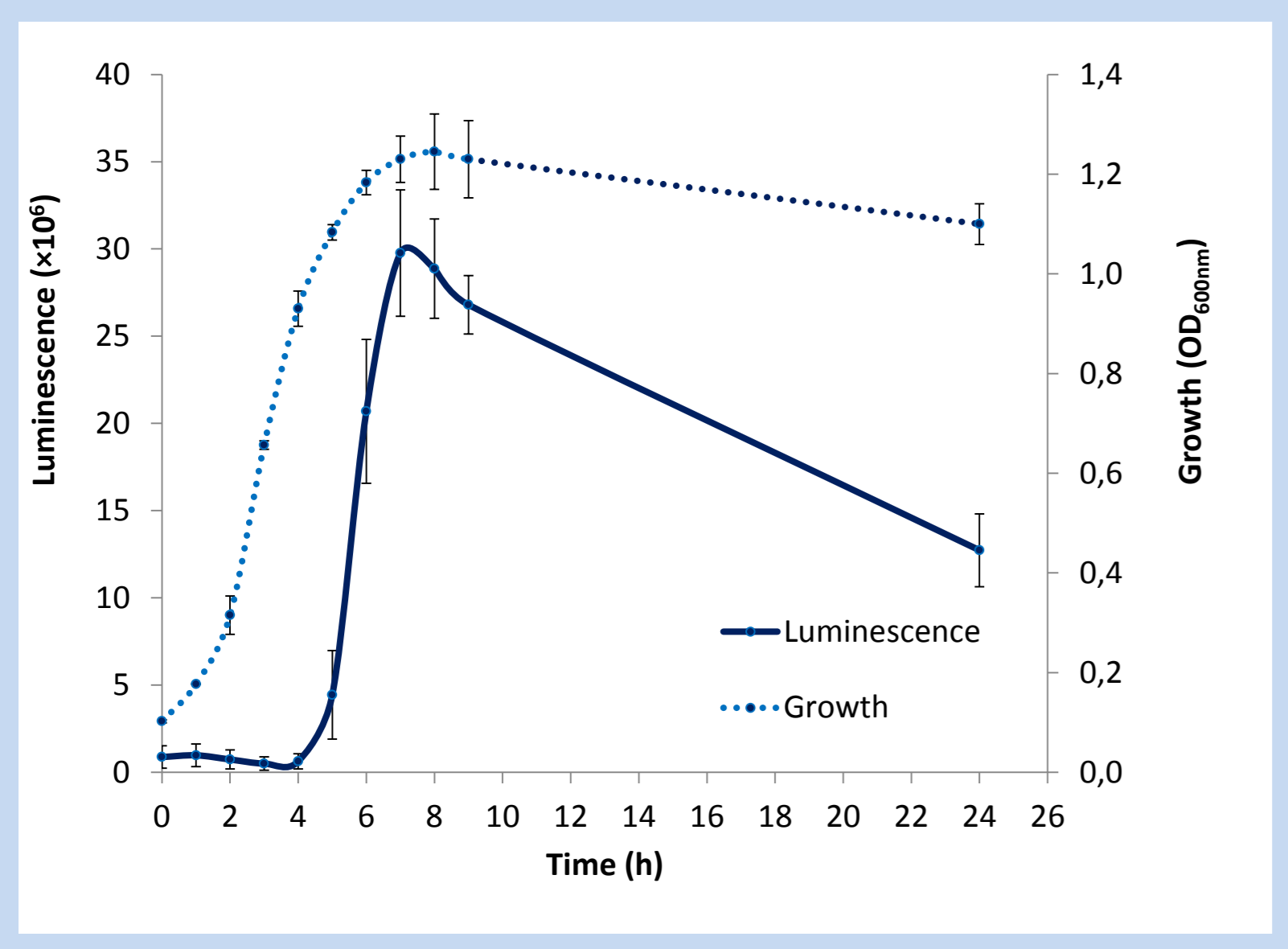

S. woodyi has an active QS system

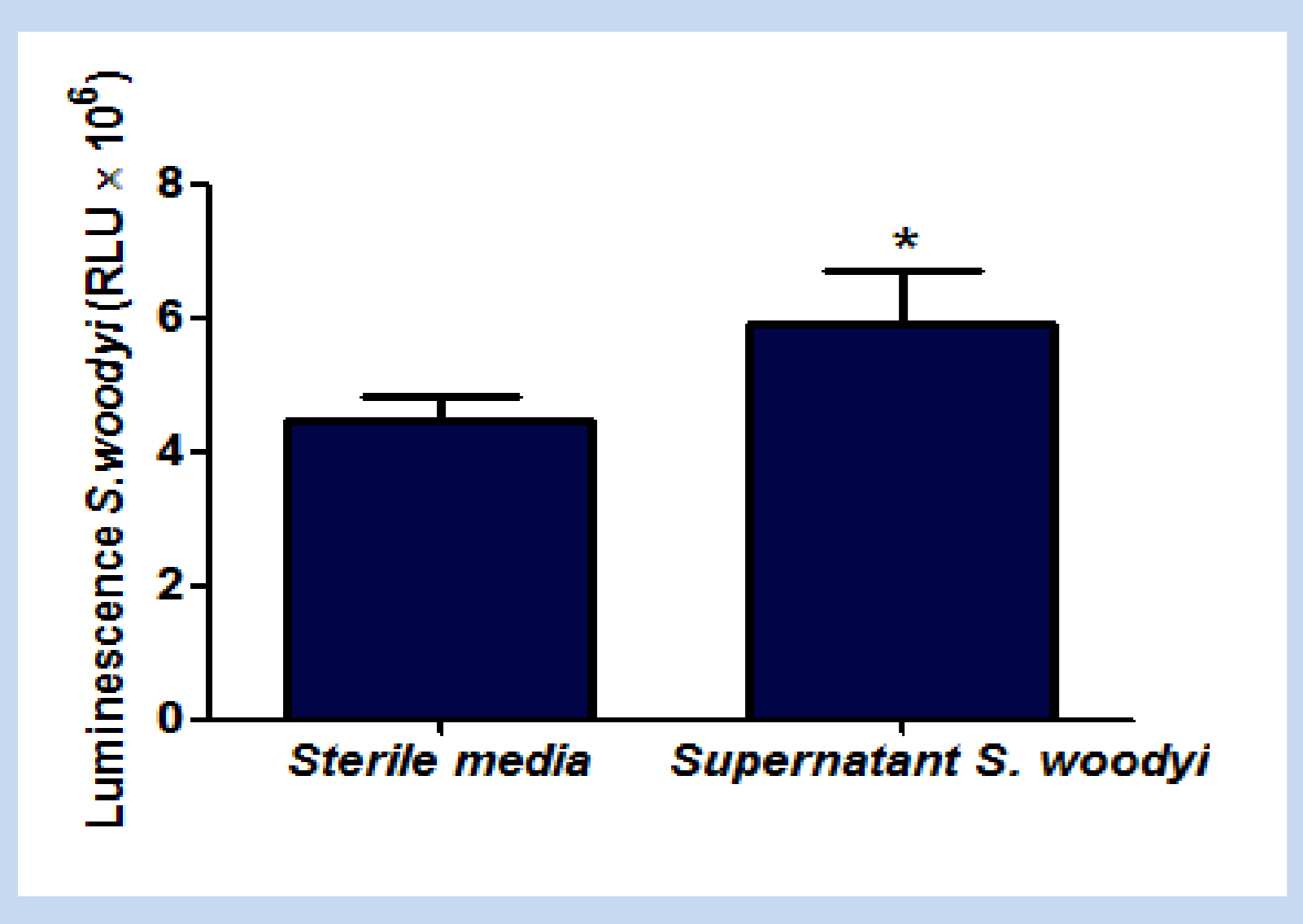

S. woodyi synthesizes the N-Octanoyl-DL-homoserine lactone (C8-AHL)

S. woodyi does not synthesize the 3OH-C4-AHL

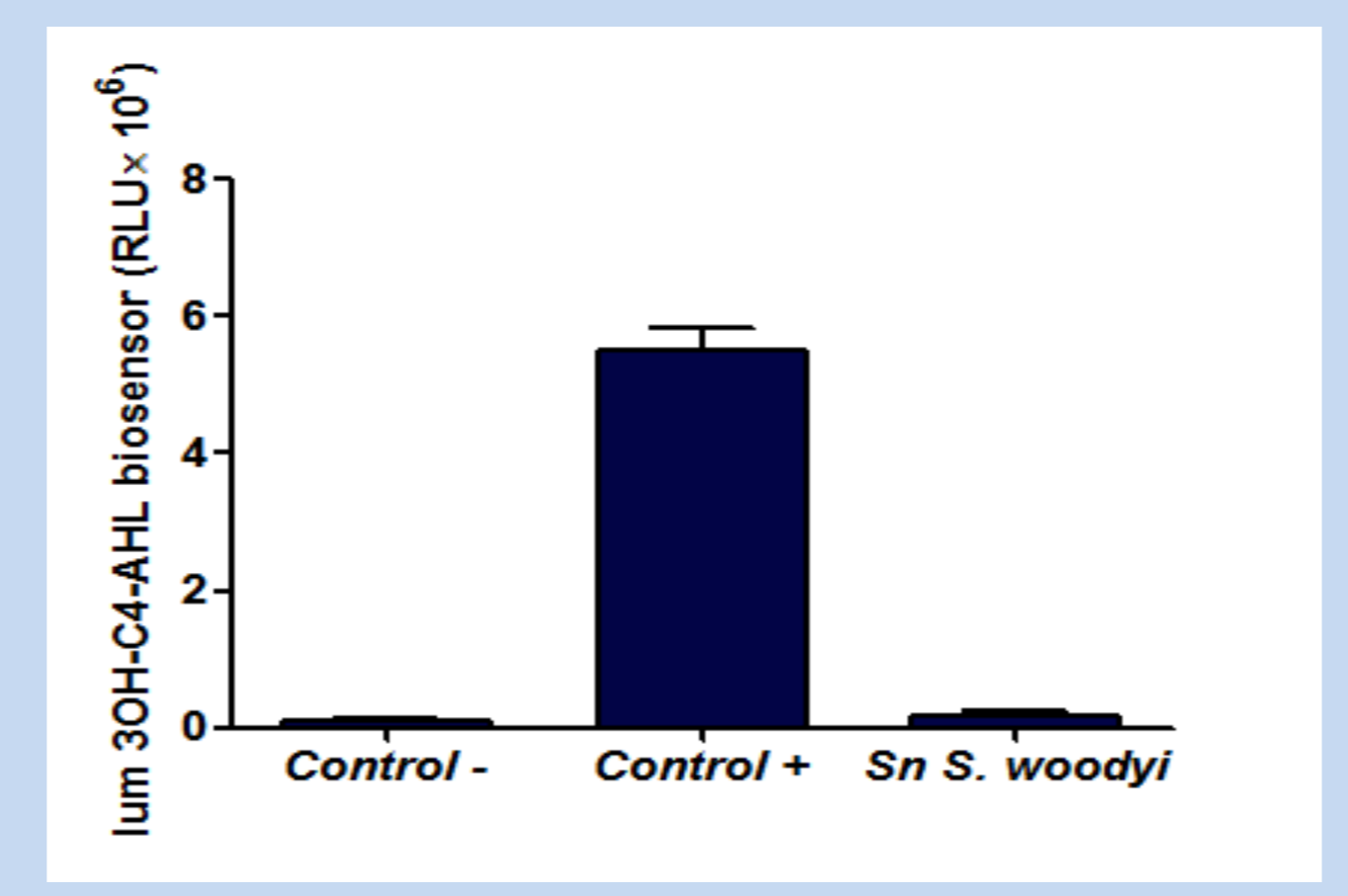

S. woodyi synthesizes one or more long side chain AHL molecules

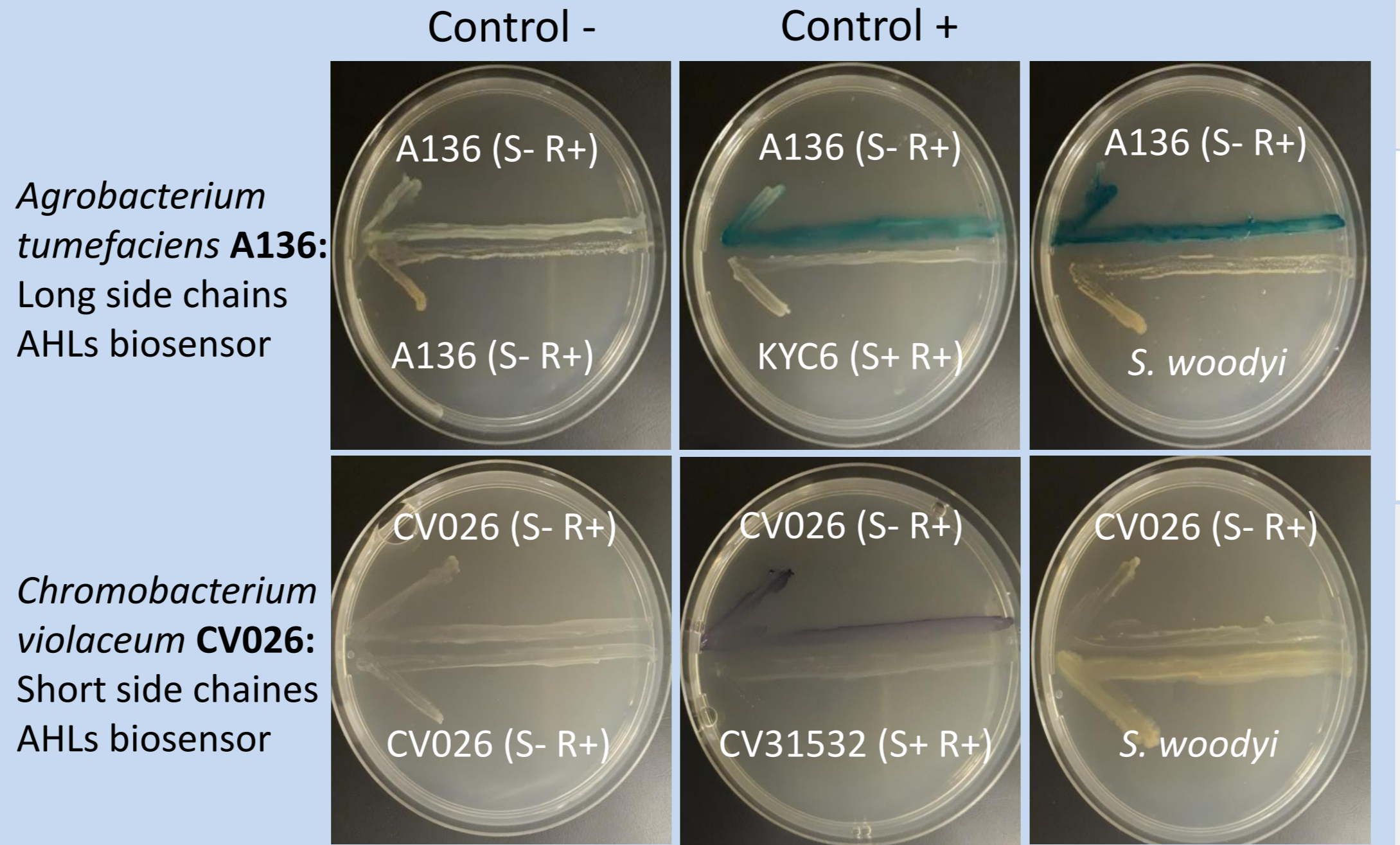

Detection of C8-AHL by LCMS in *S. woodyi* supernatant

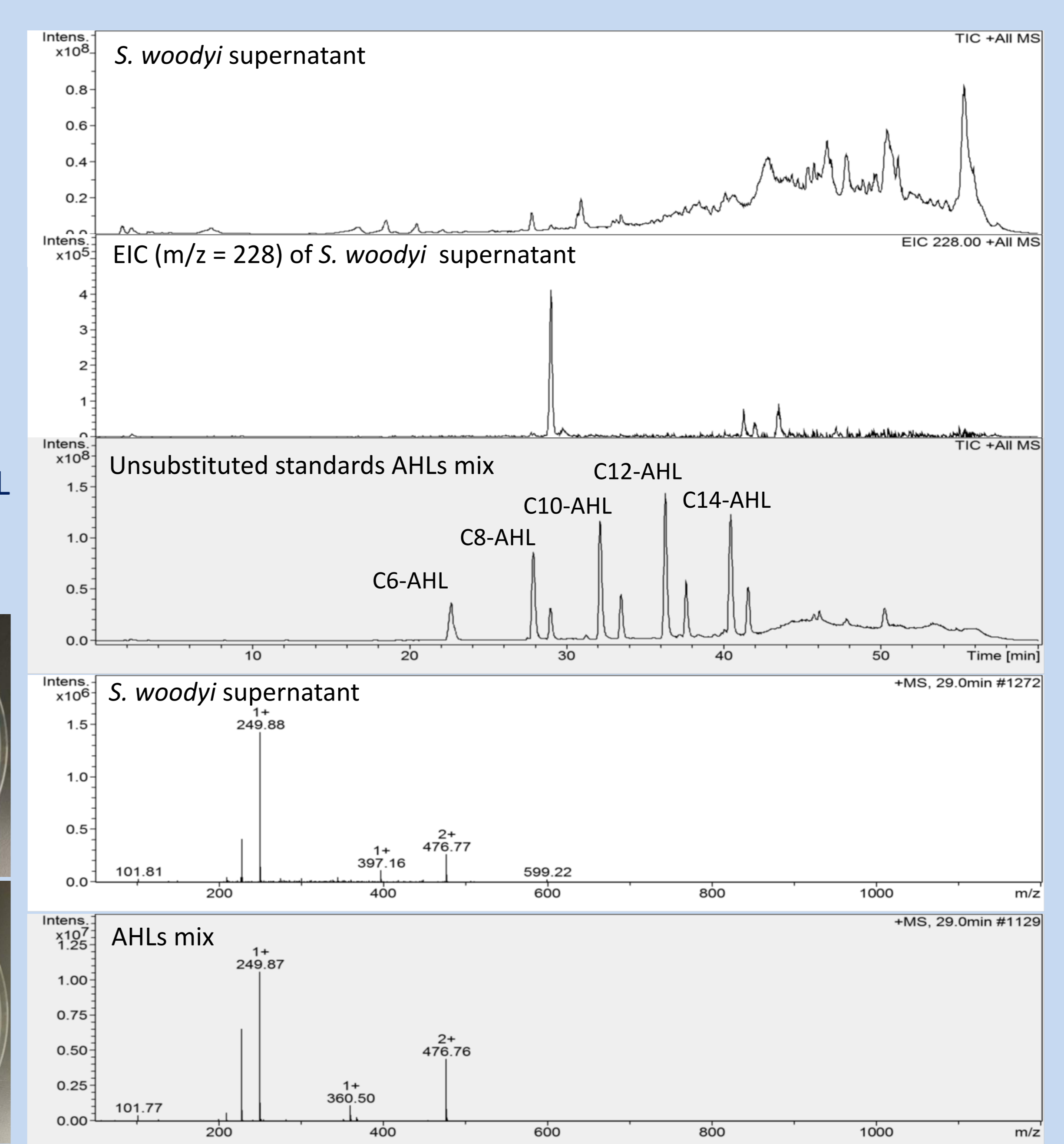

The luminescence of *S. woodyi* is regulated by QS system

C8-AHL induces *S. woodyi* luminescence
luxR or *luxI* mutation makes *S. woodyi* non luminescent

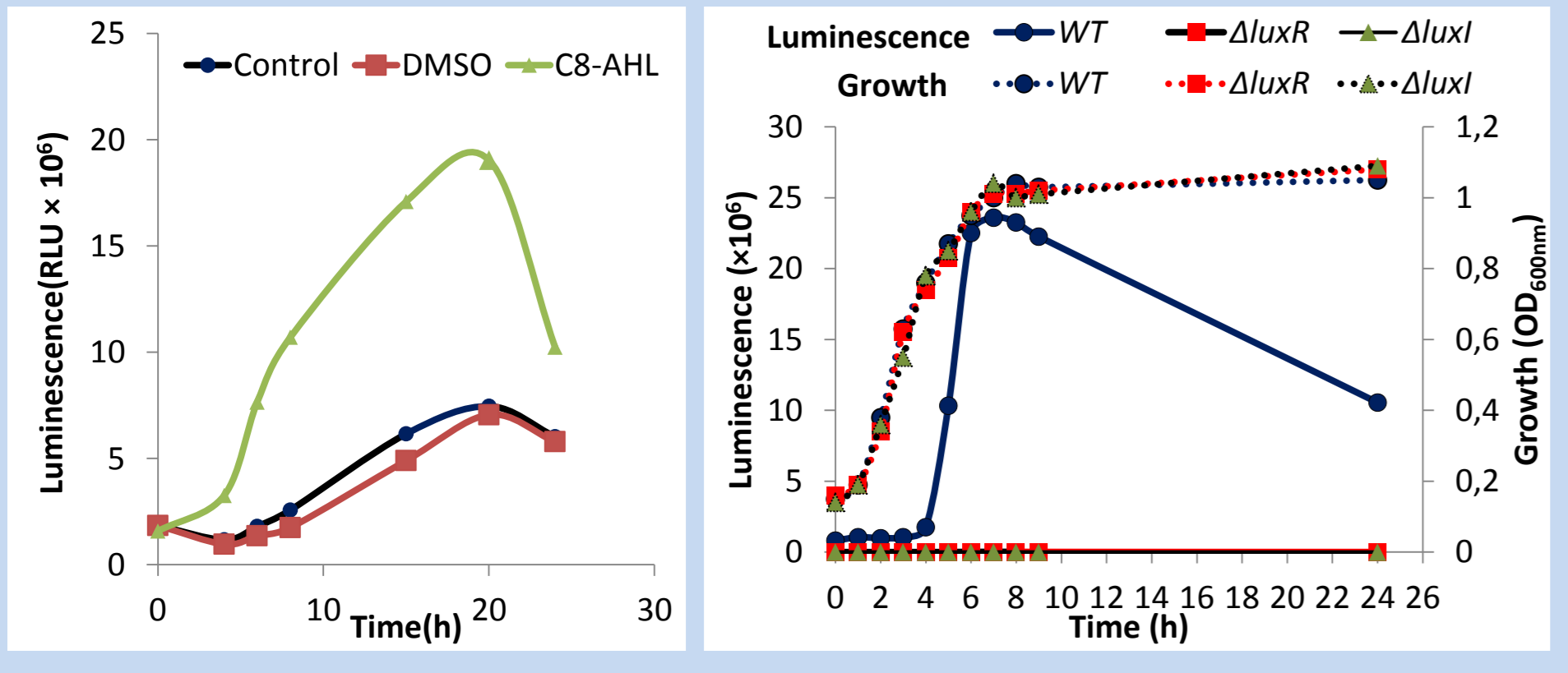

Only C8-AHL can induce luminescence in a *S. woodyi* $\Delta luxI$ background

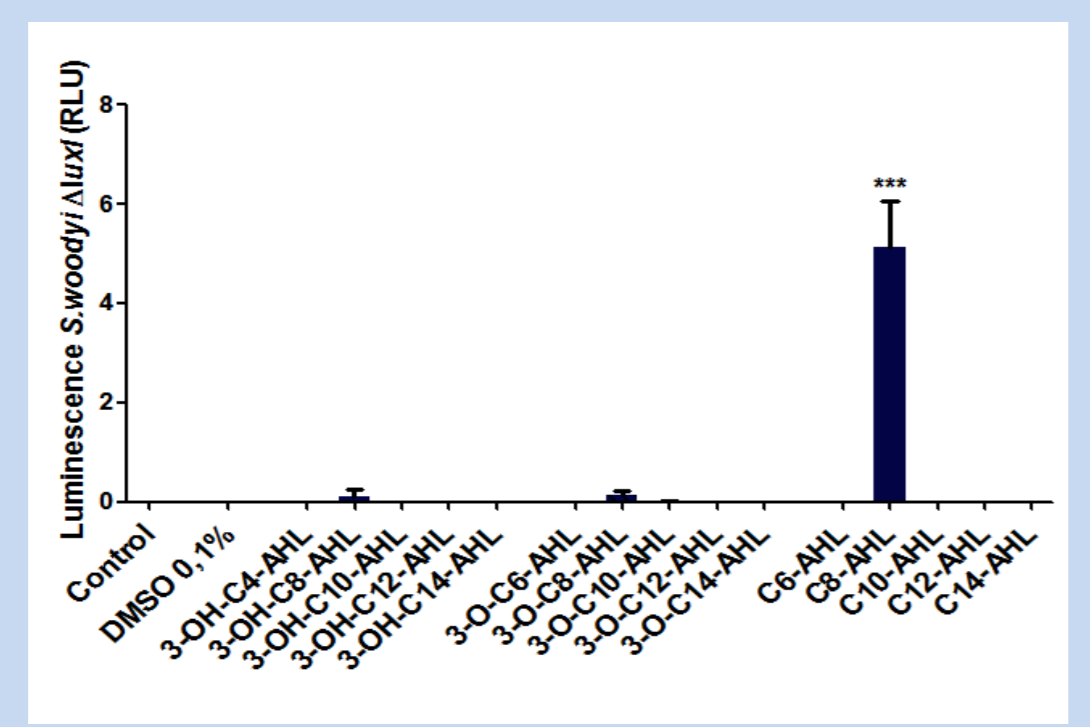

luxR or *luxI* mutants abolish QS genes expression

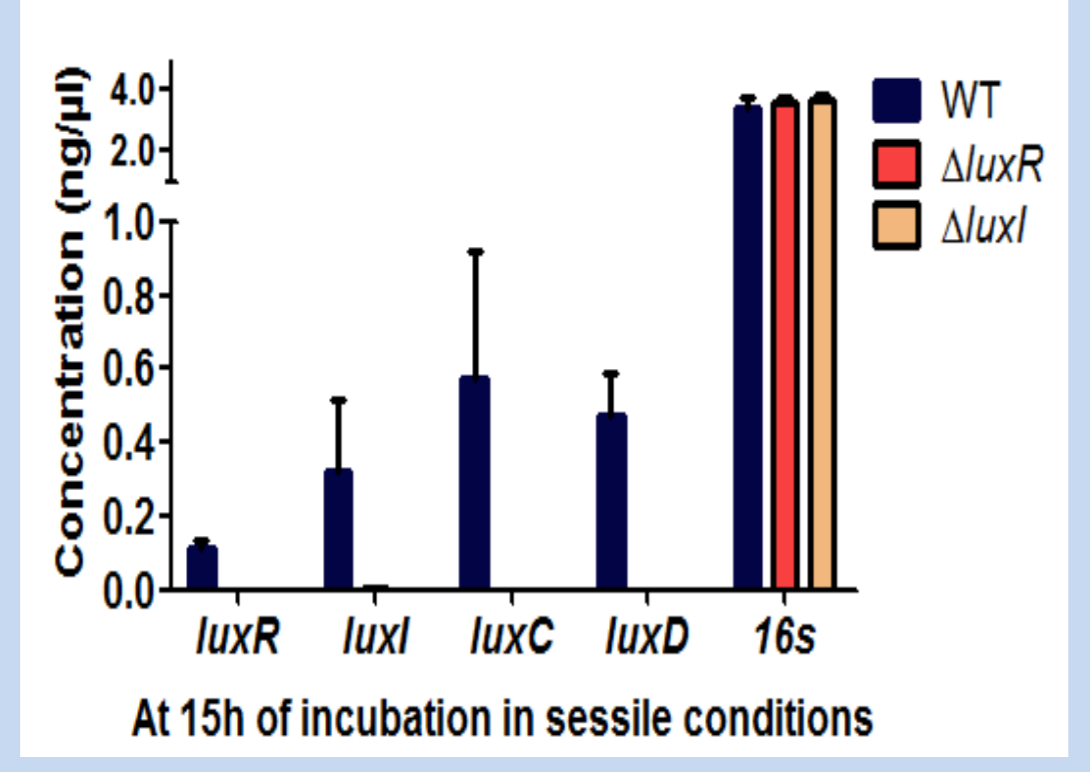

Adhesion and biofilm formation do not seem to be regulated by QS in *S. woodyi*

S. woodyi WT, $\Delta luxR$ or $\Delta luxI$ have the same adhesion and biofilm formation pattern

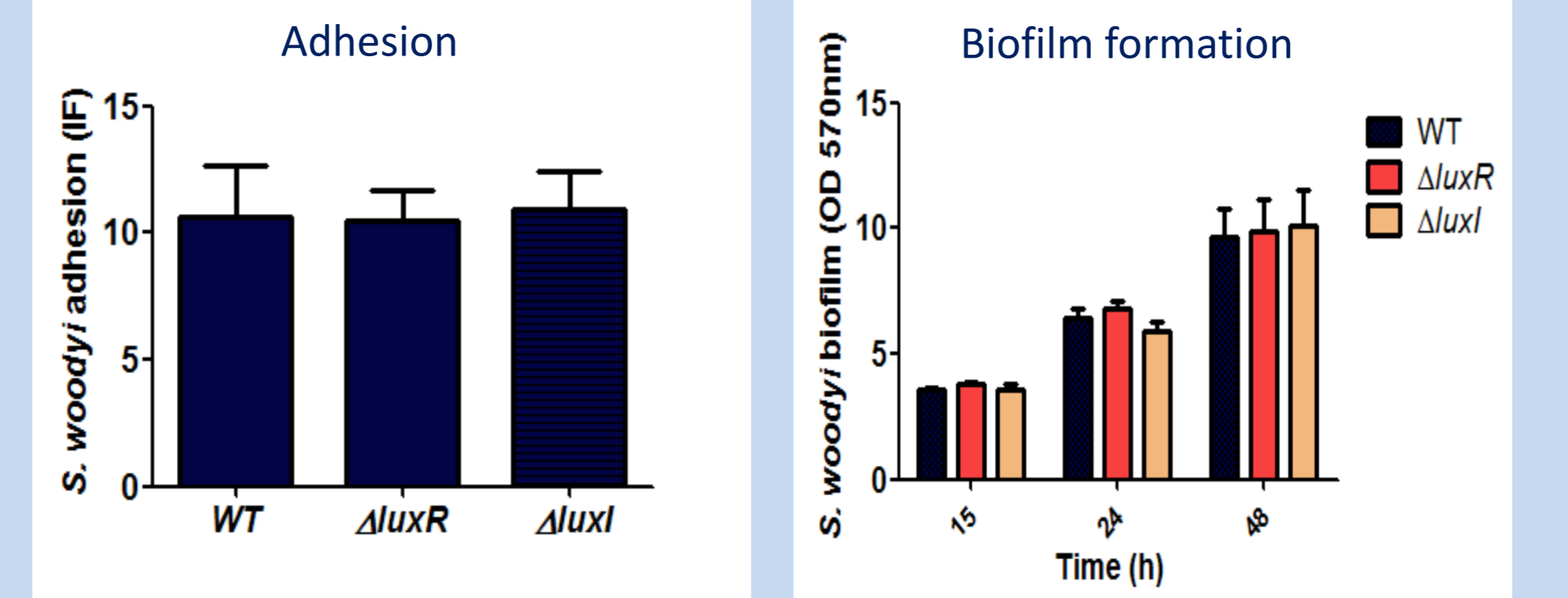

Mutation of QS genes appears to reduce phagocytosis of *S. woodyi* by amoeba eukaryotic cells

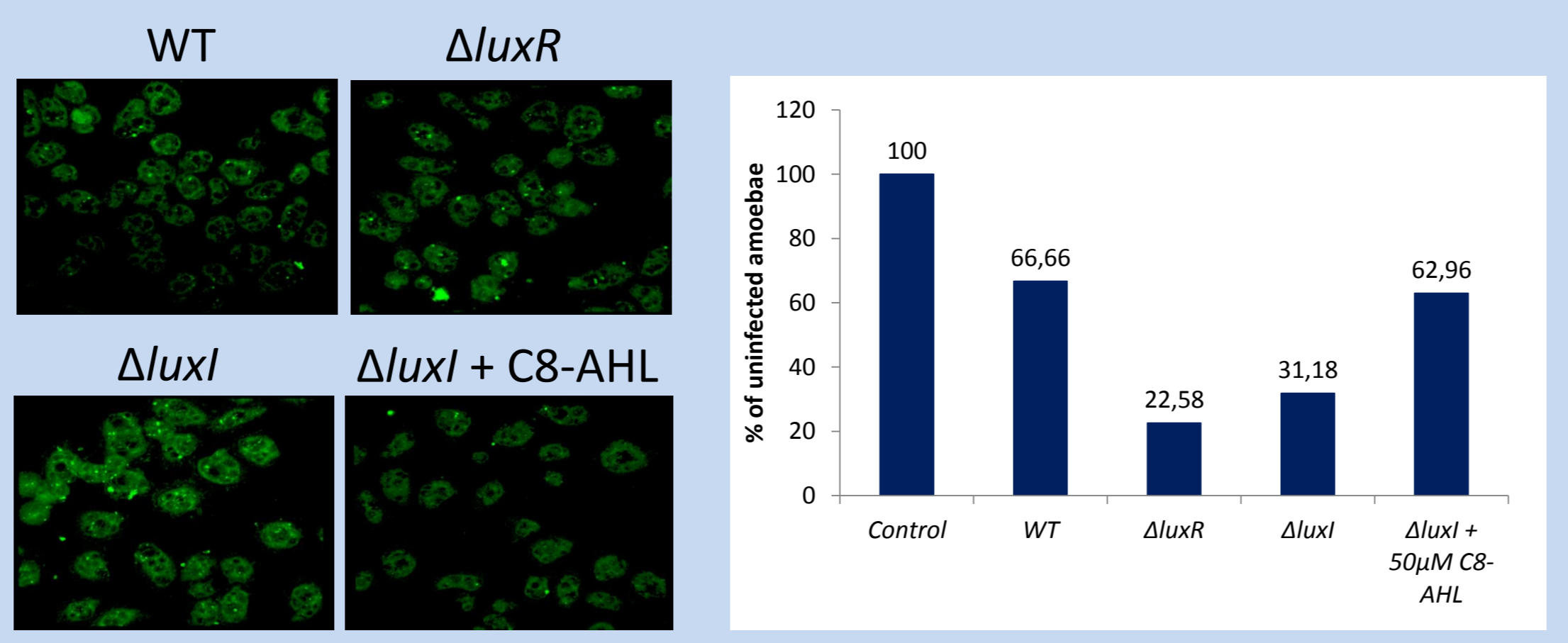

Conclusion

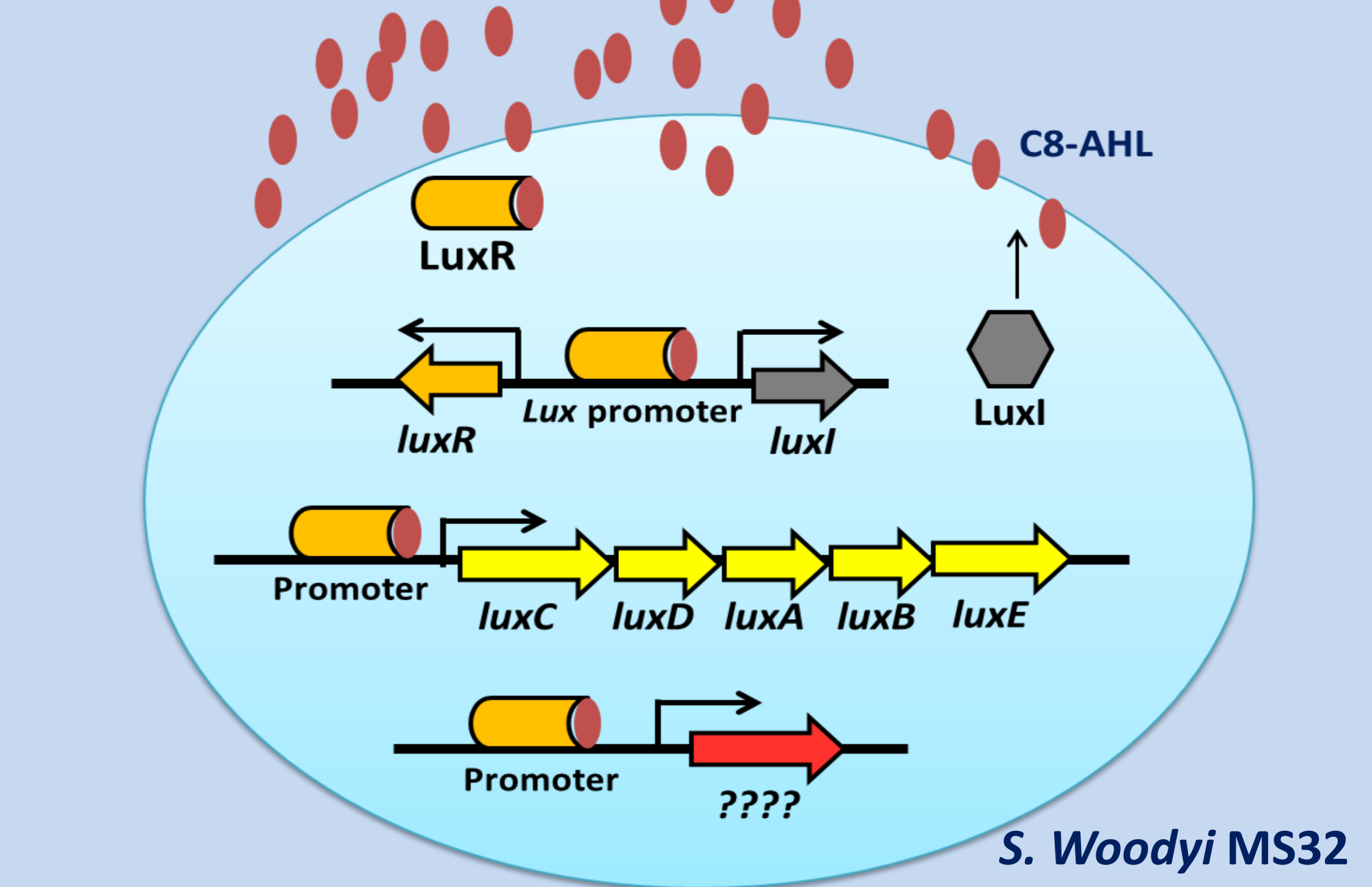

- ✓ Luminescence of *S. woodyi* is under the control of the AHL QS system
- ✓ *S. woodyi* produces and responds to C8-AHL : proof of concept to use *S. woodyi* as a biosensor to screen the synthesis of C8-AHL by other bacteria
- ✓ Exception to the general rule, QS in *Shewanella woodyi* is not involved in adhesion and biofilm formation
- ✓ Mutation of QS genes reduces phagocytosis of *S. woodyi* by amoeba eukaryotic cells