



**HAL**  
open science

## Integrated sensor fault estimation and control for continuous-time switched systems: A new separation principle

Ayyoub Ait Ladel, Abdellah Benzaouia, Rachid Outbib, Mustapha Ouladsine

► **To cite this version:**

Ayyoub Ait Ladel, Abdellah Benzaouia, Rachid Outbib, Mustapha Ouladsine. Integrated sensor fault estimation and control for continuous-time switched systems: A new separation principle. ISA Transactions, 2021, 112, pp.224-233. 10.1016/j.isatra.2020.12.005 . hal-03560438

**HAL Id: hal-03560438**

<https://hal.science/hal-03560438v1>

Submitted on 24 May 2023

**HAL** is a multi-disciplinary open access archive for the deposit and dissemination of scientific research documents, whether they are published or not. The documents may come from teaching and research institutions in France or abroad, or from public or private research centers.

L'archive ouverte pluridisciplinaire **HAL**, est destinée au dépôt et à la diffusion de documents scientifiques de niveau recherche, publiés ou non, émanant des établissements d'enseignement et de recherche français ou étrangers, des laboratoires publics ou privés.



Distributed under a Creative Commons Attribution - NonCommercial 4.0 International License

# Integrated sensor fault estimation and control for continuous-time switched systems: a new separation principle

Ayyoub Ait Ladel<sup>a,b</sup>, Abdellah Benzaouia<sup>a,c</sup>, Rachid Outbib<sup>b</sup>, Mustapha Ouladsine<sup>b</sup>

<sup>a</sup> LAEPT, Physics Department, Faculty of Sciences Semlalia, Cadi Ayyad University, P.B.2390, Marrakech, Morocco

E-mail : [ayyoub.aitladel@gmail.com](mailto:ayyoub.aitladel@gmail.com)

E-mail : [benzaouia@uca.ac.ma](mailto:benzaouia@uca.ac.ma)

<sup>b</sup> LIS Laboratory (UMR CNRS 7020), Aix-Marseille University, 13397 Marseille, France

E-mail : [rachid.outbib@lis-lab.fr](mailto:rachid.outbib@lis-lab.fr)

E-mail : [mustapha.ouladsine@lis-lab.fr](mailto:mustapha.ouladsine@lis-lab.fr)

<sup>c</sup> Modeling, Information, and Systems Laboratory, University of Picardie Jules Verne, UFR of Sciences, 33 Rue St Leu Amiens 80000, France

This paper addresses the state/fault estimation and observer-based control issues for switched systems with sensor faults. The objective is to design observer-based controllers that allow stabilizing this system class even in the presence of sensor faults. A new separation principle is developed to formalize the observer-based controller design in the form of linear matrix inequalities (LMI) instead of bilinear ones.

We confirm that this manuscript has not been published elsewhere and is not under consideration for another journal. All authors have approved the manuscript and agree with its submission to the ISA Transactions journal.

This research did not receive any specific grant from funding agencies in the public, commercial, or not-for-profit sectors.

Declarations of interest: none.

# Integrated sensor fault estimation and control for continuous-time switched systems: a new separation principle

---

## Abstract

In this paper, we address the state/fault estimation and observer-based control issues for switched systems with sensor faults. The main objective is to estimate sensor faults and compensate for their effects on the system state estimation, and then stabilize the switched system by the estimated state feedback. Applying the mode-dependent average dwell time (MDADT) concept and the Lyapunov stability theory, a new separation principle is developed, which allows formalizing the observer-based controller design in the form of linear matrix inequalities (LMI) instead of bilinear ones. Finally, a highly maneuverable aircraft technology (HiMAT) example, a DC-DC boost converter example, and a numerical example are investigated to show the practicability and efficiency of the obtained results.

*Keywords:* Fault estimation, Observer-based control, Switched systems, Separation principle, Linear matrix inequality (LMI)

---

## 1. Introduction

Switched systems represent a class of hybrid systems, which consist of a finite set of modes (subsystems), each mode has its dynamics, and a controlled or autonomous switching law that orchestrates the switching and indicates the active mode. This system class has an important function in various applications in the industry because many practical systems in different fields (automotive industry, robotics, power systems, aircraft and traffic control, etc.) can be represented by switched system models (see [1, 2, 3]).

The stability and stabilization problems for switched systems are complex and interesting because even if all subsystems are stable, the switching signal can destabilize the system (see [4, 5]). Various interesting results have been obtained in the literature on switched system stability, among the best ones, the dwell time (DT) concept [6, 7]. Based on this concept, stability conditions can be established as a function of switching signals and mode dynamics. In practice, switching signals are limited in frequency, so it is reasonable to represent them by a minimum average dwell time. Thus, the DT has become more flexible through the development of the average dwell time (ADT) approach [8, 9]. Thereafter, the ADT is extended to the mode-dependent average dwell time (MDADT) concept [10, 11, 12]. This new concept is less restrictive and allows to associate to each mode an ADT.

On the other hand, industrial systems and their equipment are becoming more and more sophisticated due to technological evolution, which increases the possibility of the occurrence of faults in the system, sensors, or actuators. These faults lead the system to undesirable behaviors and can even destabilize it. Therefore, system reliability and security have become major objectives in the control theory. This reality has motivated many researchers to focus more on the fault detection (FD), fault estimation (FE), and fault-tolerant control (FTC) issues.

The FD problem has already been addressed for switched systems, and several research papers have been published on this topic (see [13, 14, 15, 16]). These papers propose several FD techniques that can be used to provide the occurrence instant of the fault but without precise information about it, such as amplitude, type, etc. In contrast, FE/FTC techniques can be exploited to identify the amplitude, type, and temporal evolution of faults; and also to automatically compensate the fault effects on the system and thus maintain stability and performance.

In recent decades, the FE and FTC issues have received more attention from researchers because of their importance and complexity, and several important results have been achieved (see [17, 18, 19, 20, 21, 22]). **However, the FE and**

40 FTC problems are not yet sufficiently studied for switched systems with sensor faults, and there is no much research work on this topic. In [23, 24], the sensor fault estimation issue has been addressed for switched systems. These papers provide switched observers to estimate system states and sensor faults simultaneously. In [25, 26, 27], fault estimation approaches have been developed for switched systems with sensor and actuator faults. These approaches  
45 allow to estimate simultaneously the system state and the sensor and actuator faults. Although these results, the fault estimation and compensation issue for switched systems still deserves more attention, which was the motivation for this work. The objective of this paper is to design observer-based controllers  
50 able to stabilize switched systems even in the presence of sensor faults.

In general, observer-based controllers are employed when system states are not measurable or to reduce the number of sensors that can be too expensive. The problem is that the coupling between the controller and the observer complicates the design of these two units. The controller/observer coupling leads to  
55 a coupling between the dynamics of the closed-loop state and that of the estimation error. As a result, the Lyapunov stability conditions are equivalent to bilinear matrix inequalities (BMI) (see [28]). It should be noted that BMIs are very difficult to solve numerically, and that BMI optimization-based solvers can only optimize locally and their convergence cannot be guaranteed (see [28, 29]  
60 and the references therein).

In [30], a linear matrix inequality (LMI) approach has been developed to formalize the observer-based controller design in the form of LMIs instead of BMIs. This approach is based on strong additional equalities that reduce the feasibility of the resulting LMIs (see [31, 32]). To overcome this problem, several  
65 separation techniques have been developed in the literature. The main idea of these techniques is to determine the controller and the observer separately, which allows to formalize the observer-based controller design in the form of LMIs instead of BMIs. In [33], a separation technique has been established for a class of nonlinear systems. This technique allows to achieve semi-global stabilization by applying a fast high-gain observer and a globally bounded control.  
70

In [20], a separation technique based on the  $H_\infty$  approach has been developed for the observer-based controller design. This technique allows determining the controller and observer gains separately by solving a set of LMIs. The separated observer and controller design has also been addressed for switched systems in [34]. In this design, the controller and observer gains are determined separately without taking into account the coupling between the dynamics of the closed-loop state and that of the estimation error. In [35], a generalized separation principle has been developed for switched systems, which allows to design separately the observer, the controller, and the switching law. Also for this separation principle, the estimation error dynamics are not considered in the controller design phase.

In the aforementioned separation techniques, the controller and the observer are designed separately without taking into account the coupling between the dynamics of the closed-loop state and that of the estimation error, which can lead to poor performance of the resulting observer-based controller (see [28]). To overcome this drawback, a new separation principle is proposed in the present paper, which allows formalizing the observer-based controller design in the form of LMIs. In this new principle, the controller and observer gains are determined after considering the coupling between the dynamics of the state and that of the estimation error. As a result, the designed controller and observer are compatible with each other, which ensures the performance of the resulting observer-based controller.

In this work, we address the state/fault estimation and control design issues according to the MDADT concept to design controllers and observers that take into account the switching effect. The main contributions of this paper can be summarised as follows:

- (1) Address simultaneously the state/fault estimation and observer-based control issues for switched systems, unlike the papers [23, 24, 25, 26, 27], which only consider the fault estimation problem without the control design. The results provided in these papers are not applicable for unstable open-loop systems.
- (2) Design in an integrated way the observer and the controller, thus ensuring

the performance of the resulting observer-based controller, unlike the aforementioned separation techniques.

(3) Develop a new separation principle, which allows formalizing the observer-based controller design in the form of LMIs instead of BMIs, without imposing the additional equalities adopted in [30].

The rest of this paper is organized as follows: Section 2 presents the problem formulation. Section 3 provides preliminary results on the state/fault estimation and observer-based control issues for switched systems. The new separation principle is developed in Section 4. To prove the validity and effectiveness of the obtained results, three examples are studied in Section 5. The conclusion is set out in Section 6.

## 2. Problem formulation

Consider the following continuous-time switched system

$$\dot{x}(t) = A_{\sigma(t)}x(t) + B_{\sigma(t)}u(t) \quad (1)$$

$$y(t) = C_{\sigma(t)}x(t) + F_{\sigma(t)}f(t) \quad (2)$$

where  $x(t) \in \mathbb{R}^n$  is the state,  $u(t) \in \mathbb{R}^m$  and  $y(t) \in \mathbb{R}^p$  are the system input and output,  $f(t) \in \mathbb{R}^q$  is the sensor fault,  $\sigma(t) : [0, +\infty) \rightarrow \mathcal{I} = 1, \dots, N$  is the switching signal with  $N$  is the number of subsystems. For a switching sequence  $t_0 < t_1 < \dots < t_k < t_{k+1} < \dots$ ,  $\sigma(t_k) = i$  means that the subsystem  $(A_i, B_i, C_i, F_i)$  is activated during  $t \in [t_k, t_{k+1})$ . It is assumed that the pairs  $(A_i, B_i)$  are controllable, pairs  $(A_i, C_i)$  are observable, and  $\text{rank}(F_i) = q$ .

In this paper, the state/fault estimation and observer-based control issues are studied according to the mode-dependent average dwell time (MDADT) concept. Firstly, a definition and a lemma are introduced to define the MDADT concept, and to present the stability results according to this concept.

**Definition 2.1.** [10] For a switching signal  $\sigma(t)$  and any  $t \in [0, \bar{T}]$ , let  $N_{\sigma_i}(\bar{T}, t)$  be the switching numbers that the  $i^{\text{th}}$  subsystem is activated over the

interval  $[t, \bar{T}]$  and  $\bar{T}_i(\bar{T}, t)$  denote the total running time of the  $i^{\text{th}}$  subsystem over the interval  $[t, \bar{T}]$ ,  $i \in \mathcal{I}$ . We say that  $\sigma(t)$  has a mode-dependent average dwell time  $\tau_{ai}$  if there exist positive numbers  $N_{0i}$  (we call  $N_{0i}$  the mode-dependent chatter bounds here) and  $\tau_{ai}$  such that

$$N_{\sigma i}(\bar{T}, t) \leq N_{0i} + \frac{\bar{T}_i(\bar{T}, t)}{\tau_{ai}}, \forall t \in [0, \bar{T}].$$

**Lemma 2.1.** [10] Consider the continuous-time switched system

$$\dot{x}(t) = f_{\sigma(t)}(x(t)), \sigma(t) \in \mathcal{I} \quad (3)$$

and let  $\lambda_i > 0$ ,  $\mu_i > 1$  ( $i \in \mathcal{I}$ ), are some given constants. Suppose that there exist  $\mathcal{C}^1$  functions  $V_i : \mathbb{R}^n \rightarrow \mathbb{R}$ , and class  $\mathcal{K}_\infty$  functions  $\kappa_{1i}$ ,  $\kappa_{2i}$  ( $i \in \mathcal{I}$ ) such that,  $\forall i \in \mathcal{I}$ ,

$$\kappa_{1i}(\|x(t)\|) \leq V_i(x(t)) \leq \kappa_{2i}(\|x(t)\|) \quad (4)$$

$$\dot{V}_i(x(t)) \leq -\lambda_i V_i(x(t)) \quad (5)$$

and  $\forall (\sigma(t_k) = i, \sigma(t_k^-) = j) \in \mathcal{I} \times \mathcal{I}$ ,  $i \neq j$

$$V_i(x(t_k)) \leq \mu_i V_j(x(t_k)) \quad (6)$$

then the system is globally uniformly asymptotically stable (GUAS) for any switching signal with MDADT

$$\tau_{ai} \geq \tau_{ai}^* = \frac{\ln \mu_i}{\lambda_i} \quad (7)$$

130

The main objectives of this work are as follows:

- Design a state/fault estimation observer able to simultaneously estimate system states and sensor faults according to the MDADT concept.
- Design an observer-based controller that allows to stabilize the switched system according to the MDADT concept, even in the presence of sensor faults.
- Formalize the integrated observer and controller design in the form of LMIs instead of BMIs.

135



### 3. Preliminary results

In this section, we develop a fault/state estimation observer that allows to  
 140 estimate system states and sensor faults simultaneously. Then, based on this  
 observer, the switched system is stabilised by an estimated state feedback and  
 the fault effects are compensated.

As indicated in [18], the sensor faults  $f(t)$  can be considered as auxiliary states.  
 Thus, each mode of the switched system (1)-(2) can be rewritten as follows:

$$L\dot{\bar{x}}(t) = \bar{A}_i\bar{x}(t) + \bar{B}_i u(t) \quad (8)$$

$$y(t) = \bar{C}_i\bar{x}(t) \quad (9)$$

where:

$$\bar{x}(t) = \begin{bmatrix} x(t) \\ f(t) \end{bmatrix}, \quad L = \begin{bmatrix} \mathbb{I}_n & 0 \\ 0 & 0 \end{bmatrix}, \quad \bar{A}_i = \begin{bmatrix} A_i & 0 \\ 0 & 0 \end{bmatrix}$$

$$\bar{B}_i = \begin{bmatrix} B_i \\ 0 \end{bmatrix}, \quad \bar{C}_i = \begin{bmatrix} C_i & F_i \end{bmatrix}$$

The equation (8) is then developed as follows, adding  $N_i\dot{y}(t)$  to both sides  
 with  $N_i = \begin{bmatrix} N_{1i}^T & N_{2i}^T \end{bmatrix}^T \in \mathbb{R}^{(n+p) \times p}$ .

$$\bar{L}_i\dot{\bar{x}}(t) = \bar{A}_i\bar{x}(t) + \bar{B}_i u(t) + N_i\dot{y}(t) \quad (10)$$

The matrices  $N_i$  must be chosen so that  $\bar{L}_i = \begin{bmatrix} \mathbb{I} + N_{1i}C_i & N_{1i}F_i \\ N_{2i}C_i & N_{2i}F_i \end{bmatrix}$  are of full  
 column rank, to ensure that  $\bar{L}_i$  have left inverse matrices  $\bar{L}_i^- = (\bar{L}_i^T \bar{L}_i)^{-1} \bar{L}_i^T$ .  
 Multiplying both sides of equation (10) by  $\bar{L}_i^-$ , we get:

$$\dot{\bar{x}}(t) = \bar{\mathcal{A}}_i\bar{x}(t) + \bar{\mathcal{B}}_i u(t) + \mathcal{N}_i\dot{y}(t), \quad (11)$$

145 where  $\bar{\mathcal{A}}_i = \bar{L}_i^- \bar{A}_i$ ,  $\bar{\mathcal{B}}_i = \bar{L}_i^- \bar{B}_i$  and  $\mathcal{N}_i = \bar{L}_i^- N_i$ . Based on this new state  
 representation, we design a state/fault estimation observer that allows to si-  
 multaneously estimate system states and sensor faults. The observer is given

by:

$$\dot{\hat{x}}(t) = \bar{\mathcal{A}}_{\sigma(t)}\hat{x}(t) + \bar{\mathcal{B}}_{\sigma(t)}u(t) + \mathcal{N}_{\sigma(t)}\dot{y}(t) + K_{\sigma(t)}(y(t) - \hat{y}(t)) \quad (12)$$

$$\hat{y}(t) = \bar{\mathcal{C}}_{\sigma(t)}\hat{x}(t) \quad (13)$$

where  $K_i \in \mathbb{R}^{(n+a) \times p}$ ,  $i \in \mathcal{I}$  are the observer gains. To avoid the derivative  $\dot{y}(t)$  in the second member of equation (12), we apply, for each subsystem  $i$ ,  $i \in \mathcal{I}$ , the following state transformation:

$$\hat{z}(t) = \hat{x}(t) - \mathcal{N}_i y(t) \quad (14)$$

Based on this state transformation, the system state  $x(t)$  and the sensor faults  $f(t)$  can be estimated as follows:

$$\dot{\hat{z}}(t) = \bar{\mathcal{A}}_i \hat{z}(t) + \bar{\mathcal{A}}_i \mathcal{N}_i y(t) + \bar{\mathcal{B}}_i u(t) + K_i (y(t) - \hat{y}(t)) \quad (15)$$

$$\hat{x}(t) = \hat{z}(t) + \mathcal{N}_i y(t) \quad (16)$$

The dynamics of the observation error  $e(t) = \bar{x}(t) - \hat{x}(t)$  for each subsystem  $i$ ,  $i \in \mathcal{I}$  is given by the following equation:

$$\begin{aligned} \dot{e}(t) &= \dot{\bar{x}}(t) - \dot{\hat{x}}(t) \\ &= \bar{\mathcal{A}}_i \bar{x}(t) + \bar{\mathcal{B}}_i u(t) + \mathcal{N}_i \dot{y}(t) - [\bar{\mathcal{A}}_i \hat{x}(t) + \bar{\mathcal{B}}_i u(t) + \mathcal{N}_i \dot{y}(t) + K_i (y(t) - \hat{y}(t))] \\ &= (\bar{\mathcal{A}}_i - K_i \bar{\mathcal{C}}_i) e(t) \end{aligned} \quad (17)$$

Let  $e(t) = \begin{bmatrix} e_x^T(t) & e_f^T(t) \end{bmatrix}^T$ , where  $e_x(t) = x(t) - \hat{x}(t)$  is the state estimation error, and  $e_f(t) = f(t) - \hat{f}(t)$  is the fault estimate error.

Now, we propose a controller based on the state/fault estimation observer (15)-(16) to stabilize the closed-loop system even in the presence of sensor faults.

The controller is given by:

$$u(t) = R_{\sigma(t)} \hat{x}(t) \quad (18)$$

where  $R_i \in \mathbb{R}^{m \times n}$ ,  $i \in \mathcal{I}$  are the controller gains. The dynamics of each closed-loop subsystem is given by the following equation:

$$\dot{x}(t) = (A_i + B_i R_i) x(t) - B_i R_i e_x(t) \quad (19)$$

The objective now is to determine the controller and observer gains  $R_i$  and  $K_i$ , ( $i \in \mathcal{I}$ ), taking into account the coupling between the dynamics of the closed-loop state and that of the observation error. For this purpose, we develop the augmented system composed of the system state  $x(t)$  and the observation error  $e(t)$  as follows:

$$\begin{bmatrix} \dot{x}(t) \\ \dot{e}(t) \end{bmatrix} = \begin{bmatrix} A_{\sigma(t)} + B_{\sigma(t)}R_{\sigma(t)} & \begin{bmatrix} -B_{\sigma(t)}R_{\sigma(t)} & 0 \end{bmatrix} \\ 0 & \bar{\mathcal{A}}_{\sigma(t)} - K_{\sigma(t)}\bar{\mathcal{C}}_{\sigma(t)} \end{bmatrix} \begin{bmatrix} x(t) \\ e(t) \end{bmatrix} \quad (20)$$

According to the MDADT concept, the augmented system (20) is globally uniformly asymptotically stable if conditions (5) and (6) are satisfied. Consider the Lyapunov function of the following form:

$$V_i(\mathcal{X}(t)) = \mathcal{X}^T(t)P_i\mathcal{X}(t), \quad i \in \mathcal{I} \quad (21)$$

where  $\mathcal{X}(t) = \begin{bmatrix} x^T(t) & e^T(t) \end{bmatrix}^T$ ,  $P_i = \text{diag}\{P_{i1}, P_{i2}\}$ , with  $P_{i1} \in \mathbb{R}^{n \times n}$  and  $P_{i2} \in \mathbb{R}^{(n+q) \times (n+q)}$  are symmetric and positive definite matrices. Due to the coupling between the dynamics of the closed-loop state  $x(t)$  and that of the observation error  $e(t)$ , the conditions (5) and (6) are equivalent to a set of bilinear matrix inequalities (BMI) given as follows:

$$\begin{bmatrix} \Xi_{11} & \Xi_{12} \\ * & \Xi_{22} \end{bmatrix} \leq 0 \quad (22)$$

$$P_{i1} \leq \mu_i P_{j1} \quad (23)$$

$$P_{i2} \leq \mu_i P_{j2} \quad (24)$$

where:

$$\Xi_{11} = P_{i1}A_i + P_{i1}B_iR_i + A_i^T P_{i1} + R_i^T B_i^T P_{i1} + \lambda_i P_{i1}$$

$$\Xi_{12} = \begin{bmatrix} -P_{i1}B_iR_i & 0 \end{bmatrix}$$

$$\Xi_{22} = P_{i2}\bar{\mathcal{A}}_i - P_{i2}K_i\bar{\mathcal{C}}_i + \bar{\mathcal{A}}_i^T P_{i2} - \bar{\mathcal{C}}_i^T K_i^T P_{i2} + \lambda_i P_{i2}$$

These BMIs are very difficult to solve numerically, and the BMI optimization-based solvers can only optimize locally and their convergence cannot be guaranteed see [28, 29] and the references therein). In [30], an LMI design strategy

165 has been developed for linear systems to formalize the integrated observer and  
 controller design in the form of LMIs instead of BMIs. This design strategy is  
 based on strong additional equalities  $P_1 B = B \hat{P}_1$ . The problem is that these  
 equalities can reduce the feasibility of the obtained LMIs (see [31, 32]). By  
 adapting this strategy to the topic presented in the present paper, the BMIs  
 170 (22)-(24) can be linearized under the following constraints:  $P_{i1} B_i = B_i \hat{P}_{i1}$ . The  
 problem is that for switched systems, as the number of modes increases, these  
 constraints become more restrictive. The objective of the following section is  
 to formalize the integrated observer and controller design in the form of LMIs  
 instead of BMIs, without needing to include additional equalities.

#### 175 4. Main results

In this section, a new separation principle is developed, to formalize the  
 observer-based controller design in the form of LMIs instead of the BMIs (22)-  
 (24). Using this new principle, the observer and controller gains  $K_i$  and  $L_i$   
 are determined, taking into account the coupling between the dynamics of the  
 180 closed-loop state (19) and that of the estimation error (17).

**Theorem 4.1.** *Consider the augmented system equation (20). For given scalars  $\Upsilon_i > 0$ ,  $\lambda_i > 0$  and  $\mu_i > 1$ , if there exist symmetric and positive definite matrices  $X_{i1} \in \mathbb{R}^{n \times n}$ ,  $P_{i2} \in \mathbb{R}^{(n+q) \times (n+q)}$  and matrices  $Y_i \in \mathbb{R}^{m \times n}$ ,  $Z_i \in \mathbb{R}^{(n+q) \times p}$ ,  $\forall (i, j) \in \mathcal{I} \times \mathcal{I}$ ,  $i \neq j$ , such that*

$$\begin{bmatrix} A_i X_{i1} + X_{i1} A_i^T + B_i Y_i + Y_i^T B_i^T + \lambda_i X_{i1} & -B_i Y_i \\ * & -\Upsilon_i X_{i1} \end{bmatrix} \leq 0 \quad (25)$$

$$X_{j1} \leq \mu_i X_{i1} \quad (26)$$

$$P_{i2} \bar{A}_i + \bar{A}_i^T P_{i2} - Z_i \bar{C}_i - \bar{C}_i^T Z_i^T + \lambda_i P_{i2} - \Lambda_i \leq 0 \quad (27)$$

$$P_{i2} \leq \mu_i P_{j2} \quad (28)$$

where:

$$\Lambda_i = \begin{bmatrix} -\Upsilon_i P_{i1} & 0 \\ 0 & 0 \end{bmatrix}$$

then, the augmented system (20) is globally uniformly asymptotically stable (GUAS) for any switching signal satisfying these conditions  $\tau_{ai} \geq \tau_{ai}^* = \frac{\ln \mu_i}{\lambda_i}$ , applying the following controller and observer gains:  $R_i = Y_i X_{i1}^{-1}$ ,  $K_i = P_{i2}^{-1} Z_i$ , with  $P_{i1} = X_{i1}^{-1}$ .

**Proof:** The results presented in Theorem 4.1 are based on the Lyapunov function given by (21). This choice of Lyapunov function leads to determine the observer and controller gains, taking into account the coupling between the dynamics of  $x(t)$  and that of  $e(t)$ . We have:

$$\begin{aligned} \dot{V}_i(\mathcal{X}(t)) + \lambda_i V_i(\mathcal{X}(t)) &= 2\dot{\mathcal{X}}^T(t) P_i \mathcal{X}(t) + \lambda_i \mathcal{X}^T(t) P_i \mathcal{X}(t) \\ &= 2 \begin{bmatrix} \dot{x}^T(t) & \dot{e}^T(t) \end{bmatrix} \begin{bmatrix} P_{i1} & 0 \\ 0 & P_{i2} \end{bmatrix} \begin{bmatrix} x(t) \\ e(t) \end{bmatrix} \\ &\quad + \lambda_i \begin{bmatrix} x^T(t) & e^T(t) \end{bmatrix} \begin{bmatrix} P_{i1} & 0 \\ 0 & P_{i2} \end{bmatrix} \begin{bmatrix} x(t) \\ e(t) \end{bmatrix} \end{aligned} \quad (29)$$

We put  $A_{c_i} = A_i + B_i R_i$  and  $\bar{A}_{o_i} = \bar{A}_i - K_i \bar{C}_i$ . From formulas (17) and (19), we can develop equation (29) as follows:

$$\begin{aligned} \dot{V}_i(\mathcal{X}(t)) + \lambda_i V_i(\mathcal{X}(t)) &= 2(x^T(t) A_{c_i}^T - e_x^T(t) R_i^T B_i^T) P_{i1} x(t) + \lambda_i x^T(t) P_{i1} x(t) \\ &\quad + 2e^T(t) \bar{A}_{o_i}^T P_{i2} e(t) + \lambda_i e^T(t) P_{i2} e(t) \end{aligned} \quad (30)$$

The condition  $\dot{V}_i(\mathcal{X}(t)) + \lambda_i V_i(\mathcal{X}(t)) \leq 0$  is equivalent to the set of BMIs given by (22). These BMIs are not exploitable numerically. In the following, the objective is to formalize this condition in the form of LMIs instead of the BMIs (22).

The proposed separation technique is based on adding and subtracting the following term  $\rho(t) = e_x^T(t) \Upsilon_i P_{i1} e_x(t)$ . Thus, equation (30) can be expanded as

195 follows:

$$\begin{aligned}
\dot{V}_i(\mathcal{X}(t)) + \lambda_i V_i(\mathcal{X}(t)) = & 2(x^T(t)A_{c_i}^T - e_x^T(t)R_i^T B_i^T) P_{i1}x(t) + \lambda_i x^T(t)P_{i1}x(t) \\
& - e_x^T(t) (\Upsilon_i P_{i1}) e_x(t) + 2e^T \bar{\mathcal{A}}_{o_i}^T P_{i2}e(t) + \lambda_i e^T(t)P_{i2}e(t) \\
& + e^T(t) \begin{bmatrix} \Upsilon_i P_{i1} & 0 \\ 0 & 0 \end{bmatrix} e(t)
\end{aligned} \tag{31}$$

Therefore, the inequality  $\dot{V}_i(\mathcal{X}(t)) + \lambda_i V_i(\mathcal{X}(t)) \leq 0$  is satisfied if the following conditions are met:

$$2(x^T(t)A_{c_i}^T - e_x^T(t)R_i^T B_i^T) P_{i1}x(t) + \lambda_i x^T(t)P_{i1}x(t) - e_x^T(t) (\Upsilon_i P_{i1}) e_x(t) \leq 0 \tag{32}$$

$$2e^T(t)\bar{\mathcal{A}}_{o_i}^T P_{i2}e(t) + \lambda_i e^T(t)P_{i2}e(t) \leq -e^T(t) \begin{bmatrix} \Upsilon_i P_{i1} & 0 \\ 0 & 0 \end{bmatrix} e(t) \tag{33}$$

After a series of developments, conditions (32) and (33) can be easily formalized as inequalities (25) and (27).

200 The following part is devoted to formalizing the condition (6) in the form of the inequalities (26) and (28). We have:

$$\begin{aligned}
V_i(\mathcal{X}(t_k)) - \mu_i V_j(\mathcal{X}(t_k)) = & \mathcal{X}^T(t_k)P_i\mathcal{X}(t_k) - \mu_i \mathcal{X}^T(t_k)P_j\mathcal{X}(t_k) \\
= & \begin{bmatrix} x^T(t) & e^T(t) \end{bmatrix} \begin{bmatrix} P_{i1} - \mu_i P_{j1} & 0 \\ 0 & P_{i2} - \mu_i P_{j2} \end{bmatrix} \begin{bmatrix} x(t) \\ e(t) \end{bmatrix}
\end{aligned} \tag{34}$$

Therefore, condition (6) is satisfied if the following conditions are met:

$$\begin{bmatrix} P_{i1} & 0 \\ 0 & P_{i2} \end{bmatrix} \leq \mu_i \begin{bmatrix} P_{j1} & 0 \\ 0 & P_{j2} \end{bmatrix}, \quad \forall (i, j) \in \mathcal{I} \times \mathcal{I}, \quad i \neq j \tag{35}$$

These conditions can be developed as follows:

$$P_{i1} \leq \mu_i P_{j1} \quad (36)$$

$$P_{i2} \leq \mu_i P_{j2} \quad (37)$$

Inequality (36) is equivalent to  $-X_{j1}^{-1} + \mu_i^{-1} X_{i1}^{-1} \leq 0$ , where  $X_{j1} = P_{j1}^{-1}$  and  $X_{i1} = P_{i1}^{-1}$ . We apply Schur complement twice, the inequality becomes:

$$X_{j1} \leq \mu_i X_{i1} \quad (38)$$

□

**The numerical resolution process:** The inequalities in Theorem 4.1 are  
 205 solved via the following process :

Step 1: We start by solving the LMIs (25) and (26), the controller gains are given  
 by  $R_i = Y_i X_{i1}^{-1}$ .

Step 2: Once we have the values of  $X_{i1}$ ,  $i \in \mathcal{I}$ , we proceed to solve the LMIs  
 (27) and (28). The observer gains corresponding to the controller gains  
 210 obtained in Step 1 are given by  $K_i = P_{i2}^{-1} Z_i$ .

**Remark 4.1.** *According to the MDADT concept, the switched systems are globally uniformly asymptotically stable (GUAS) for any switching signal with average dwell times satisfying the conditions  $\tau_{ai} \geq \tau_{ai}^* = \frac{\ln \mu_i}{\lambda_i}$ . Thus, parameters  $\lambda_i$  and  $\mu_i$  are chosen according to the required minimum average dwell times  $\tau_{ai}^*$ .*

215 **Remark 4.2.** • *In this work, we simultaneously study the state/fault estimation and observer-based control issues, unlike the works [23, 24, 25, 26, 27], where the fault estimation problem is addressed without control design. The results developed in these papers are limited to stable open-loop systems only. In contrast, the results of the present paper are applicable  
 220 to both unstable and stable systems.*

• *We adopt in this paper an integrated observer and controller design to take into account the interactions between these two units. Consequently,*

the designed controller and observer are compatible with each other, which ensures the performance of the resulting observer-based controller. In contrast, the separation techniques proposed in [33, 20, 34, 35] consider a separate observer and controller design to overcome the controller/observer coupling obstacle. As discussed in [28], the integrated observer and controller design gives better results in terms of estimation and control performance compared to the separated design.

- The new separation principle proposed in the present paper allows to formalize the observer-based controller design in the form of LMIs instead of BMIs, without adding the equality constraints adopted in [30]. As a result, the resulting LMIs are less conservative.

## 5. Example

To show the validity and practicability of the obtained results, we address in this section the state/fault estimation and observer-based control issues for two real systems, a highly maneuverable aircraft technology (HiMAT) vehicle and a DC-DC boost converter. Then, a switched system composed of two unstable modes is studied, considering several simultaneous sensor faults. Finally, a comparison is provided to illustrate the advantages of the developed separation principle.

### 5.1. HiMAT vehicle example

In this part, we study the HiMAT vehicle presented in [2]. This vehicle can be considered as a switched system composed of two modes, where the states  $x_1(t)$  and  $x_2(t)$  represent respectively the angle of attack and the pitch rate. The modes of this system are given as follows:

Mode 1:

$$A_1 = \begin{bmatrix} -1.35 & -0.98 \\ 17.1 & -1.85 \end{bmatrix}, \quad B_1 = \begin{bmatrix} 1.7 \\ 0.9 \end{bmatrix}, \quad C_1 = \begin{bmatrix} 1 & 0 \\ 0 & 1 \end{bmatrix}, \quad F_1 = \begin{bmatrix} 1 \\ 0 \end{bmatrix}$$



Mode 2:

$$A_2 = \begin{bmatrix} -1.87 & -0.98 \\ 12.6 & -2.63 \end{bmatrix}, \quad B_2 = \begin{bmatrix} 1.9 \\ 3.8 \end{bmatrix}, \quad C_2 = \begin{bmatrix} 1 & 0 \\ 0 & 1 \end{bmatrix}, \quad F_2 = \begin{bmatrix} 0 \\ 1 \end{bmatrix}$$

We apply the results of Theorem 4.1 for the following parameter values:  
 255  $(\mu_1 = 3, \mu_2 = 4), (\lambda_1 = 10, \lambda_2 = 11)$  and  $(\Upsilon_1 = 20, \Upsilon_2 = 30)$ . The controller and observer gains and the minimum average dwell time for each mode are given as follows:

$$R_1 = \begin{bmatrix} -9.1577 & -3.4644 \end{bmatrix}, \quad K_1 = \begin{bmatrix} 4.3059 & 2.1671 \\ 7.1441 & 18.4250 \\ 1.0762 & -15.1268 \end{bmatrix}, \quad \tau_{a1}^* = 0.1099$$

$$R_2 = \begin{bmatrix} -3.0469 & -2.5979 \end{bmatrix}, \quad K_2 = \begin{bmatrix} 7.7841 & -0.2226 \\ -11.7557 & 1.2388 \\ 11.0393 & 4.9729 \end{bmatrix}, \quad \tau_{a2}^* = 0.1260$$

260 Applying the above controller and observer gains, the system is asymptotically stable for any switching signal with MDADT satisfying the following conditions  $\tau_{ai} \geq \tau_{ai}^*, \forall i \in \mathcal{I}$ . For simulation purposes, we adopt the switching signal presented in Figure 1.

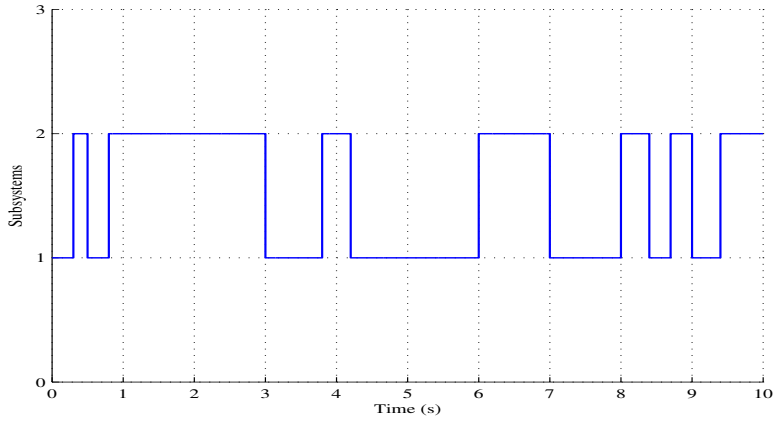

Figure 1: The evolution of the switching signal  $\sigma(t)$

265 Considering the sensor fault defined in Figure 4, the system states and their estimates are presented in Figures 2 and 3.

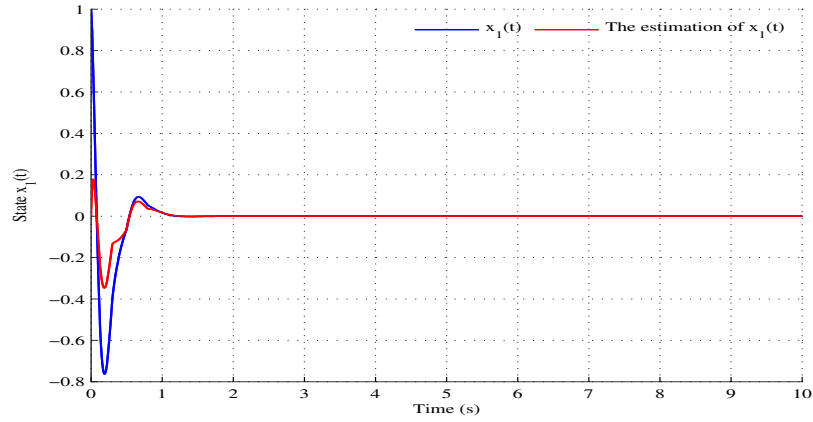

Figure 2: The state  $x_1(t)$  and its estimate in the presence of the sensor fault  $f(t) = \cos(1.5\pi t)$

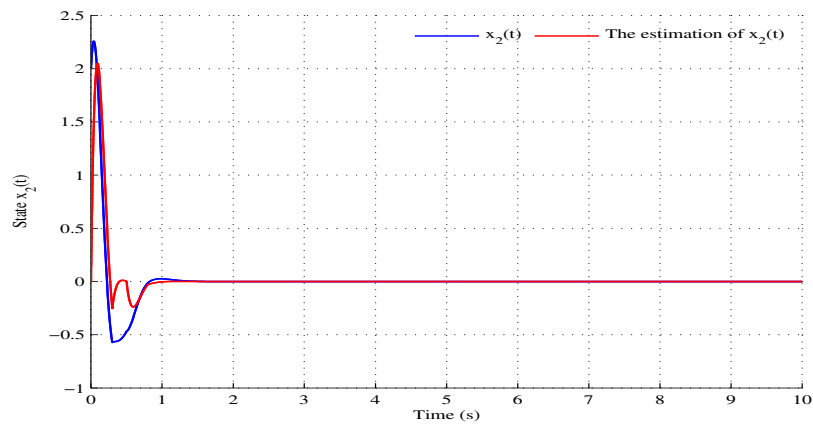

Figure 3: The state  $x_2(t)$  and its estimate in the presence of the sensor fault  $f(t) = \cos(1.5\pi t)$

From Figures 2 and 3, we can see that the system states are stabilized, and the effect of the sensor fault  $f(t)$  is completely compensated. The sensor fault

$f(t)$  and its estimate are shown in Figure 4.

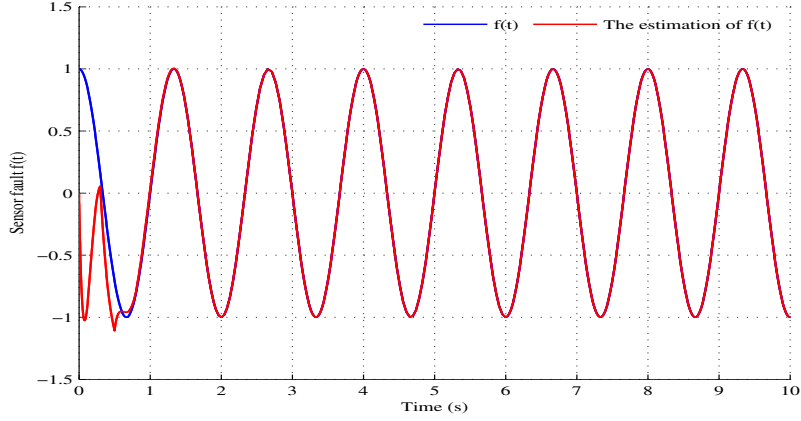

Figure 4: The sensor fault  $f(t)$  and its estimate

We have tested several fault shapes and found that the proposed observer  
 270 can perfectly estimate these faults.

### 5.2. DC-DC boost converter example

Now, we consider the DC-DC boost converter system addressed in [1]. This  
 system is illustrated in Figure 5, and its dynamics is defined as follows:

$$\begin{aligned}
 275 \quad x(t) &= \begin{bmatrix} i_L(t) \\ U_C(t) \end{bmatrix}, u(t) = \begin{bmatrix} V_{in}(t) \\ i_{load}(t) \end{bmatrix} \\
 A_{\sigma(t)} &= \begin{bmatrix} -\frac{R}{L} & -\frac{s_1}{L} \\ \frac{s_1}{C} & 0 \end{bmatrix}, B_{\sigma(t)} = \begin{bmatrix} \frac{1}{L} & 0 \\ 0 & -\frac{1}{C} \end{bmatrix}, C_{\sigma(t)} = \begin{bmatrix} 1 & 0 \\ 0 & 1 \end{bmatrix}, F_{\sigma(t)} = \begin{bmatrix} 0 \\ 1 \end{bmatrix}
 \end{aligned}$$

where  $i_L(t)$  and  $U_C(t)$  are the system states represent respectively the in-  
 280 ductor current and the capacitor voltage.  $V_{in}(t)$  and  $i_{load}(t)$  are the system  
 inputs represent the voltage source and the current source.  $s_k$  is the switching  
 parameter,  $s_k = 0$  indicates that the switch  $Sw_k$  is open, and  $s_k = 1$  indicates  
 that the switch  $Sw_k$  is closed,  $k = 1, 2$ . The boost converter parameters are

given as follows:  $R = 0.082\Omega$ ,  $L = 5\text{mH}$ , and  $C = 2.85\text{mF}$ . This system is  
 285 composed of two modes as explained in Table I.

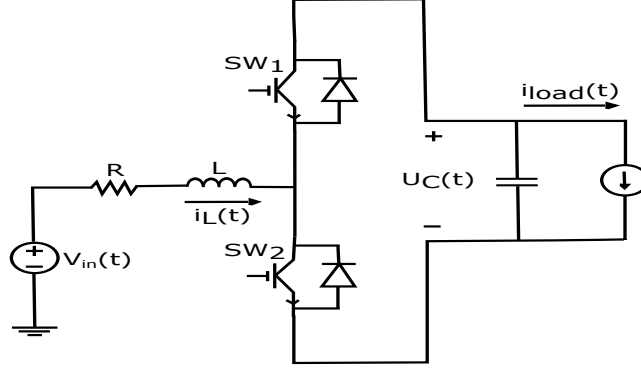

Figure 5: DC-DC Boost converter

$\sigma(t)$	mode 1	mode 2
$s_1$	0	1
$s_2$	1	0

We apply the results of Theorem 4.1 for the following parameter values:  $(\mu_1 = 3, \mu_2 = 4)$ ,  $(\lambda_1 = 12, \lambda_2 = 8)$  and  $(\Upsilon_1 = 20, \Upsilon_2 = 20)$ . The controller and observer gains and the minimum average dwell time for each mode are given as follows:

$$\begin{aligned}
 290 \quad R_1 &= \begin{bmatrix} -0.0980 & 0.0001 \\ -0.0001 & 0.0552 \end{bmatrix}, K_1 = \begin{bmatrix} -6.1179 & -0.1433 \\ 0.0389 & 6.9713 \\ 13.1469 & 0.1164 \end{bmatrix}, \tau_{a1}^* = 0.0916 \\
 R_2 &= \begin{bmatrix} -0.1070 & 0.0031 \\ -0.0010 & 0.0699 \end{bmatrix}, K_2 = \begin{bmatrix} -2.5470 & -11.9513 \\ 13.0887 & -5.6578 \\ 7.7610 & 33.5624 \end{bmatrix}, \tau_{a2}^* = 0.1733
 \end{aligned}$$

Applying the above controller and observer gains, the system is asymptotically stable for any switching signal with MDADT satisfying the following conditions  $\tau_{ai} \geq \tau_{ai}^*, \forall i \in \mathcal{I}$ . For simulation purposes, we adopt the switching signal

295 presented in Figure 6.

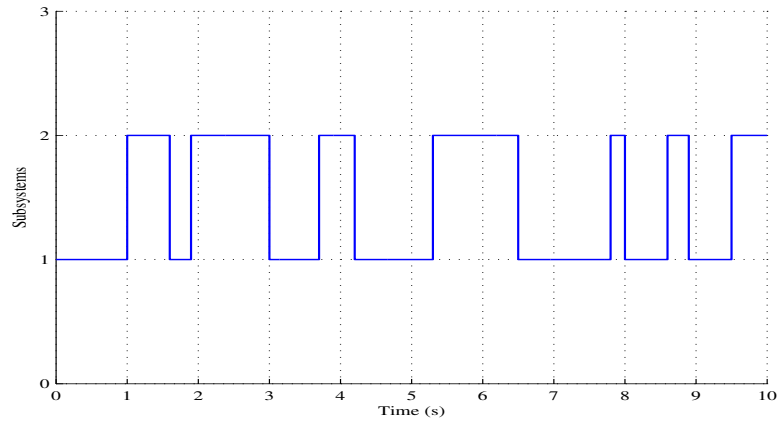

Figure 6: The evolution of the switching signal  $\sigma(t)$

Considering the sensor fault defined in Figure 9, the system states and their estimates are presented in Figures 7 and 8.

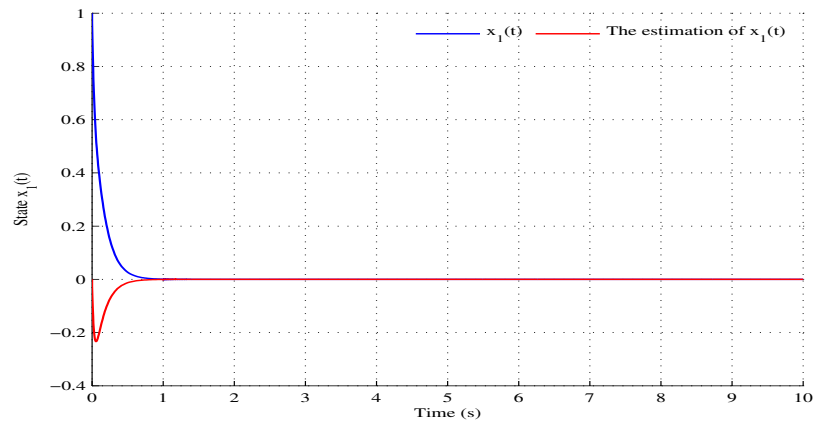

Figure 7: The state  $x_1(t)$  and its estimate in the presence of the sensor fault  $f(t) = \cos(1.5\pi t)$

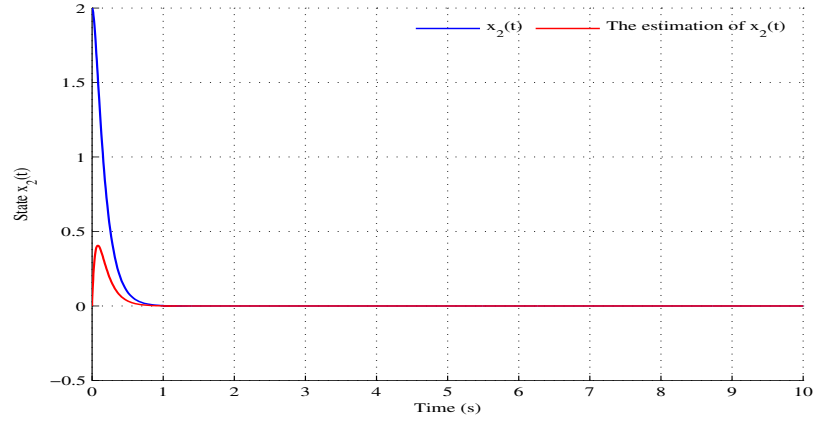

Figure 8: The state  $x_2(t)$  and its estimate in the presence of the sensor fault  $f(t) = \cos(1.5\pi t)$

From Figures 7 and 8, we can see that the system states are stabilized, and the effect of the sensor fault  $f(t)$  is completely compensated. The sensor fault  $f(t)$  and its estimate are shown in Figure 9.

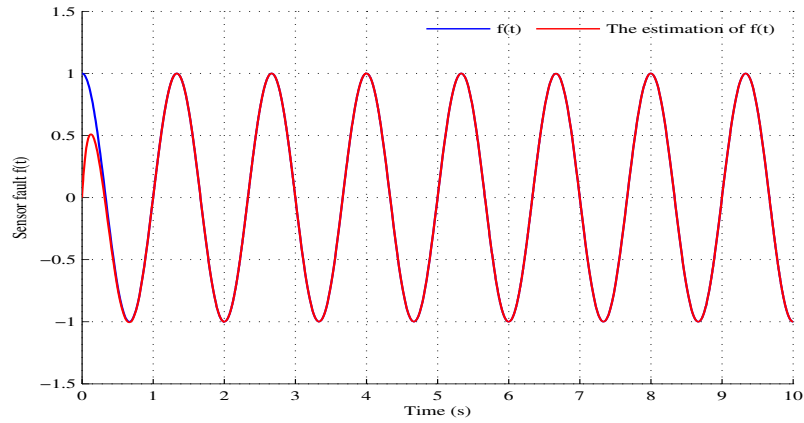

Figure 9: The sensor fault  $f(t)$  and its estimate

We have tested several fault shapes and found that the proposed observer

can perfectly estimate these faults.

### 5.3. Numerical example

In this part, we investigate a switched system composed of two unstable  
 305 modes, considering two simultaneous sensor faults. The objective of this exam-  
 ple is to evaluate the developed controller/observer performance in the presence  
 of unstable modes and several simultaneous faults. The modes of this system  
 are defined as follows:

310 Mode 1:

$$A_1 = \begin{bmatrix} -1 & 2.3 & 0.5 \\ 0.1 & 3 & 1.6 \\ 0.6 & 1 & -1 \end{bmatrix}, B_1 = \begin{bmatrix} 1.1 & 0.3 \\ 0.2 & 3.3 \\ 0.8 & 1.5 \end{bmatrix}, C_1 = \begin{bmatrix} 1 & 0.3 & 0.2 \\ 2 & 1.2 & -1 \\ 2 & 0.3 & -0.4 \end{bmatrix}, F_1 = \begin{bmatrix} 1 & 0 \\ 0 & 1 \\ 0 & 0 \end{bmatrix}$$

Mode 2:

$$A_2 = \begin{bmatrix} -0.5 & -1.3 & 2.5 \\ -1.1 & -0.9 & 2.1 \\ 3 & -0.9 & 2.7 \end{bmatrix}, B_2 = \begin{bmatrix} 3.2 & 1.6 \\ -1.6 & -0.8 \\ 0.4 & 0.2 \end{bmatrix}, C_2 = \begin{bmatrix} 0.7 & 1.5 & 1.2 \\ -0.6 & 2.7 & 1.4 \\ 0.7 & -1 & 3 \end{bmatrix},$$

315  $F_2 = \begin{bmatrix} 1 & 0 \\ 0 & 1 \\ 0 & 0 \end{bmatrix}$

We apply the results of Theorem 4.1 for the following parameter values:  
 ( $\mu_1 = 8, \mu_2 = 10$ ), ( $\lambda_1 = 3.5, \lambda_2 = 6.5$ ) and ( $\Upsilon_1 = 60, \Upsilon_2 = 60$ ). The con-  
 troller and observer gains and the minimum average dwell time for each mode  
 320 are given as follows:

$$R_1 = \begin{bmatrix} -5.6624 & 1.4270 & -8.9317 \\ -0.9140 & -5.0546 & -0.2267 \end{bmatrix}, K_1 = \begin{bmatrix} 2.5048 & 3.2911 & -5.9597 \\ -10.8980 & -16.0685 & 54.2852 \\ -3.4320 & -5.1695 & 19.7797 \\ 23.3026 & 30.1079 & -95.0684 \\ 36.5666 & 56.2215 & -168.7093 \end{bmatrix},$$

$\tau_{a1}^* = 0.5941$

$$R_2 = \begin{bmatrix} -5.0320 & -2.4722 & -13.5951 \\ -2.6418 & -1.1161 & -6.4103 \end{bmatrix}, K_2 = \begin{bmatrix} -1.8214 & -0.4565 & 5.6085 \\ 13.6983 & 1.2308 & -24.8217 \\ 5.2011 & 0.3654 & -5.9834 \\ -18.8500 & -1.0805 & 39.9843 \\ -45.4191 & 2.9416 & 80.0806 \end{bmatrix},$$

$$\tau_{a2}^* = 0.3542$$

325 Applying the above controller and observer gains, the system is asymptotically stable for any switching signal with MDADT satisfying the following conditions  $\tau_{ai} \geq \tau_{ai}^*, \forall i \in \mathcal{I}$ . For simulation purposes, we adopt the switching signal presented in Figure 10.

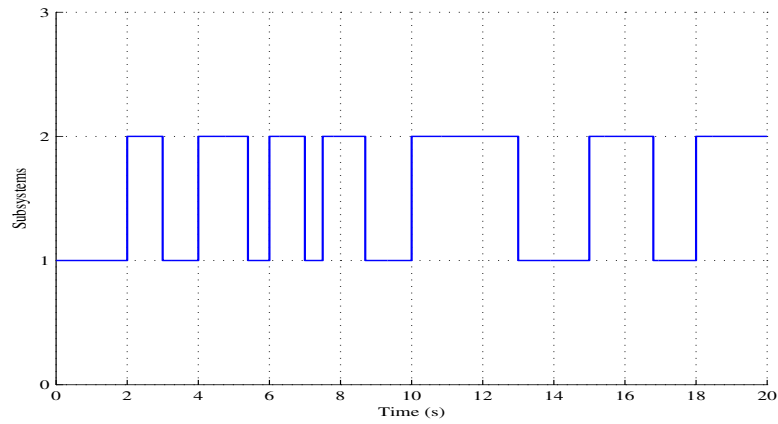

Figure 10: The evolution of the switching signal  $\sigma(t)$

330 Considering the sensor faults defined in Figures 14 and 15, the system states and their estimates are presented in Figures 11-13.



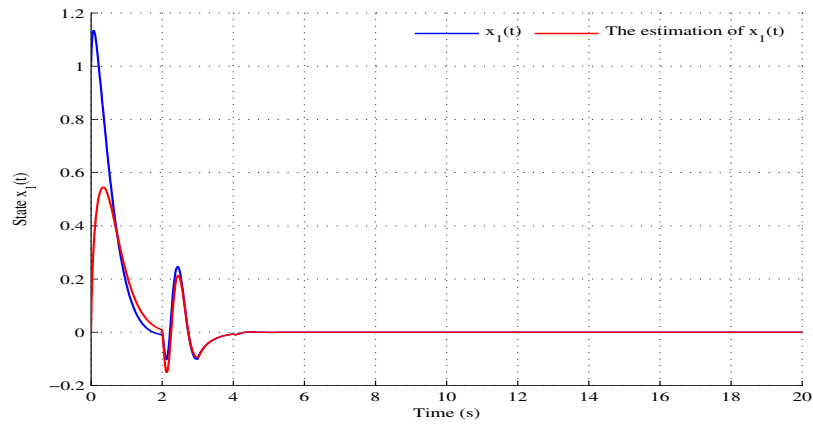

Figure 11: The state  $x_1(t)$  and its estimate in the presence of the sensor faults  $f_1(t) = \cos(\pi t)$  and  $f_2(t) = 1$

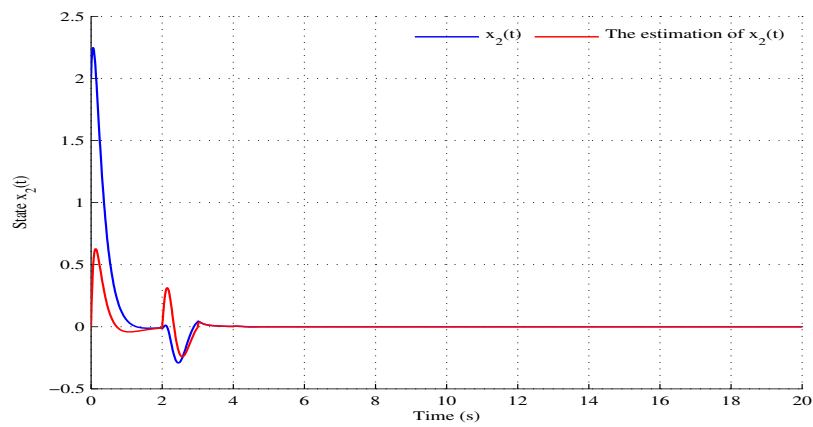

Figure 12: The state  $x_2(t)$  and its estimate in the presence of the sensor faults  $f_1(t) = \cos(\pi t)$  and  $f_2(t) = 1$

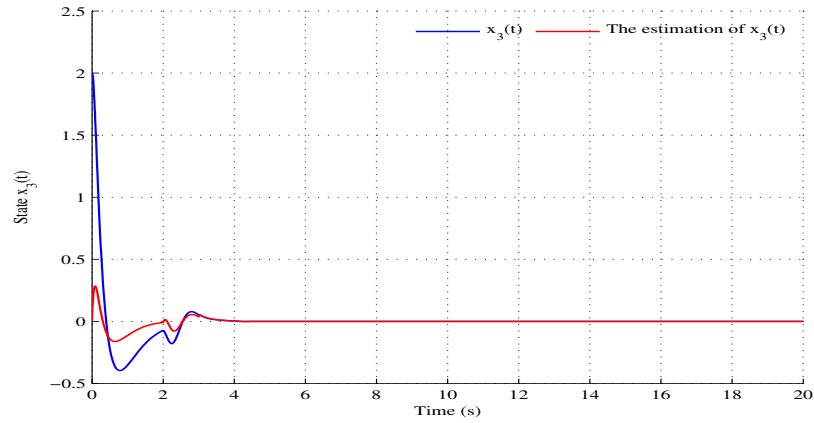

Figure 13: The state  $x_3(t)$  and its estimate in the presence of the sensor faults  $f_1(t) = \cos(\pi t)$  and  $f_2(t) = 1$

From Figures 11-13, we can see that the system states are stabilized, and the effect of the sensor faults is completely compensated. The sensor faults  $f_1(t)$  and  $f_2(t)$  and their estimates are shown in Figures 14 and 15.

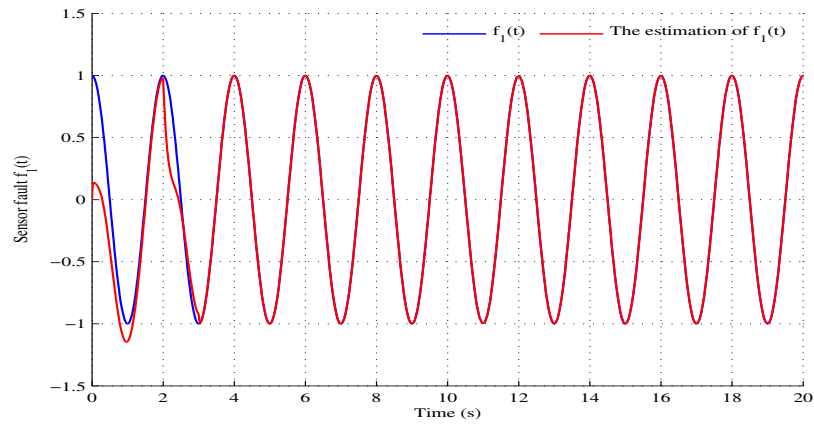

Figure 14: The sensor fault  $f_1(t)$  and its estimate

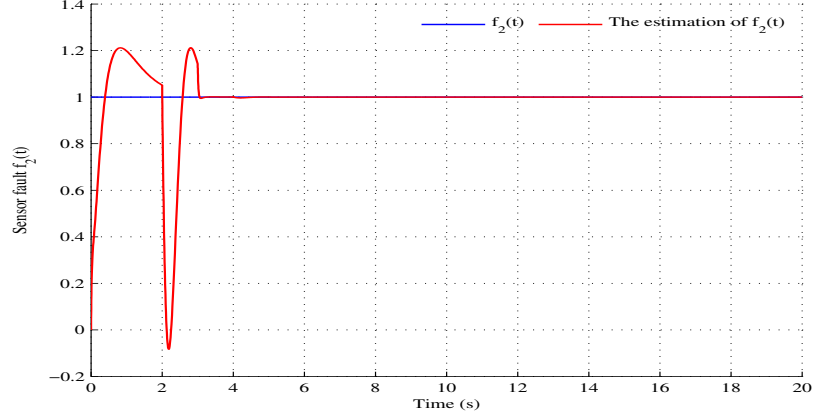

Figure 15: The sensor fault  $f_2(t)$  and its estimate

We can observe that the developed state/fault estimation observer and observer-  
 335 based controller perform very well even in the presence of unstable modes and  
 several simultaneous sensor faults.

**Comparison results:** The separation principle developed in the present  
 paper allows formalizing the observer-based controller design in the form of  
 340 LMIs instead of BMIs, without needing to add the equality constraints adopted  
 in [30]. To prove the efficiency of this new principle, we compare it with the LMI  
 design approach developed in [30], by comparing the minimum average dwell  
 times  $\tau_{ai}^*$ ,  $i \in \mathcal{I}$  (see Tables II-IV).

Table II: The minimum average dwell times for the HiMAT vehicle example

Reference	$\tau_{a1}^*$	$\tau_{a2}^*$
This paper	0.0304	0.0644
[30]	0.0957	0.1206

Table III: The minimum average dwell times for the DC-DC boost converter example

Reference	$\tau_{a1}^*$	$\tau_{a2}^*$
This paper	0.0702	0.0023
[30]	0.0702	0.0023

Table IV: The minimum average dwell times for the numerical example

Reference	$\tau_{a1}^*$	$\tau_{a2}^*$
This paper	0.0917	0.2298
[30]	infeasible	

Note that more the values of  $\tau_{ai}^* = \frac{\ln \mu_i}{\lambda_i}$  are low, more the conditions  $\tau_{ai} \geq$   
 345  $\tau_{ai}^*$ ,  $i \in \mathcal{I}$  become less restrictive. Consequently, the switched system can be  
 stabilized for a broader switching signal class. **The comparisons presented in  
 Tables II-IV prove that the proposed separation principle gives less conservative  
 results.**

## 6. Conclusion

350 In this work, the state/fault estimation and stabilization problems have  
 been studied for switched systems with mode-dependent average dwell time  
 (MDADT), in order to design observer-based controllers that can stabilize switched  
 systems even in the presence of sensor faults.

The proposed separation principle allows to formalize the observer-based con-  
 355 troller design in the form of LMIs instead of BMIs. In this new principle, the  
 observer and controller gains are determined after considering the coupling be-  
 tween the dynamics of the closed-loop state and that of the estimation error. As  
 a result, the designed controller and observer are compatible with each other,  
 which ensures the performance of the resulting observer-based controller.

360 **The comparison made in the previous section proves that the separation prin-  
 ciple developed gives less conservative results, thus leading to a broader appli-**

cation of the obtained methods.

The studied examples show that the obtained results are applicable and effective, even in the presence of unstable modes and several simultaneous sensor  
365 faults.

## References

- [1] J. Li, X. Guo, C. Chen, Q. Su, Robust fault diagnosis for switched systems based on sliding mode observer, *Applied Mathematics and Computation* 341 (2019) 193–203. doi:10.1016/j.amc.2018.08.036.
- 370 [2] Y. Eddoukali, A. Benzaouia, M. Ouladsine, Integrated fault detection and control design for continuous-time switched systems under asynchronous switching, *ISA transactions*doi:10.1016/j.isatra.2018.10.009.
- [3] B. Wang, H. Zhang, G. Wang, C. Dang, S. Zhong, Asynchronous control of discrete-time impulsive switched systems with mode-  
375 dependent average dwell time, *Isa Transactions* 53 (2) (2014) 367–372. doi:10.1016/j.isatra.2013.11.019.
- [4] H. Lin, P. J. Antsaklis, Stability and stabilizability of switched linear systems: a survey of recent results, *IEEE Transactions on Automatic control* 54 (2) (2009) 308–322. doi:10.1109/TAC.2008.2012009.
- 380 [5] D. Liberzon, A. S. Morse, Basic problems in stability and design of switched systems, *IEEE Control systems* 19 (5) (1999) 59–70. doi:10.1109/37.793443.
- [6] L. I. Allerhand, U. Shaked, Robust stability and stabilization of linear switched systems with dwell time, *IEEE Transactions on Automatic Control* 56 (2) (2011) 381–386. doi:10.1109/TAC.2010.2097351.  
385
- [7] L. I. Allerhand, U. Shaked, Robust stability and controller synthesis of discrete linear switched systems with dwell time, *International Journal of Control* 85 (6) (2012) 735–745. doi:10.1080/00207179.2012.663937.

- [8] J. P. Hespanha, A. S. Morse, Stability of switched systems with  
390 average dwell-time, in: Decision and Control, 1999. Proceedings of  
the 38th IEEE Conference on, Vol. 3, IEEE, 1999, pp. 2655–2660.  
doi:10.1109/CDC.1999.831330.
- [9] Q. Zheng, H. Zhang, Mixed  $H_\infty$  and passive filtering for switched Takagi-  
Sugeno fuzzy systems with average dwell time, ISA transactions 75 (2018)  
395 52–63. doi:10.1016/j.isatra.2018.02.014.
- [10] X. Zhao, L. Zhang, P. Shi, M. Liu, Stability and stabilization  
of switched linear systems with mode-dependent average dwell time,  
IEEE Transactions on Automatic Control 57 (7) (2012) 1809–1815.  
doi:10.1109/TAC.2011.2178629.
- 400 [11] H. Zhang, D. Xie, H. Zhang, G. Wang, Stability analysis for discrete-  
time switched systems with unstable subsystems by a mode-dependent  
average dwell time approach, ISA transactions 53 (4) (2014) 1081–1086.  
doi:10.1016/j.isatra.2014.05.020.
- [12] Y. Yin, X. Zhao, X. Zheng, New stability and stabilization condi-  
405 tions of switched systems with mode-dependent average dwell time,  
Circuits, Systems, and Signal Processing 36 (1) (2017) 82–98.  
doi:10.1007/s00034-016-0306-7.
- [13] A. Benzaouia, Y. Eddoukali, Robust Fault Detection and Control  
for Continuous-Time Switched Systems with Average Dwell Time,  
410 Circuits, Systems, and Signal Processing 37 (6) (2018) 2357–2373.  
doi:10.1007/s00034-017-0674-7.
- [14] D. Zhai, A.-Y. Lu, J.-H. Li, Q.-L. Zhang, Simultaneous fault detection  
and control for switched linear systems with mode-dependent average  
dwell-time, Applied Mathematics and Computation 273 (2016) 767–792.  
415 doi:10.1016/j.amc.2015.10.062.

- [15] A. Benzaouia, M. Ouladsine, A. Naamane, B. Ananou, Fault detection for uncertain delayed switching discrete-time systems, *International Journal of Innovative Computing, Information and Control* 8 (12) (2012) 8049–8062.
- [16] J. Li, J. H. Park, D. Ye, Simultaneous fault detection and control design for switched systems with two quantized signals, *ISA transactions* 66 (2017) 296–309. doi:10.1016/j.isatra.2016.10.016.
- [17] Z. Gao, X. Shi, S. X. Ding, Fuzzy state/disturbance observer design for T–S fuzzy systems with application to sensor fault estimation, *IEEE Transactions on Systems, Man, and Cybernetics, Part B (Cybernetics)* 38 (3) (2008) 875–880. doi:10.1109/TSMCB.2008.917185.
- [18] Z. Gao, H. Wang, Descriptor observer approaches for multivariable systems with measurement noises and application in fault detection and diagnosis, *Systems & Control Letters* 55 (4) (2006) 304–313.
- [19] X.-P. Xie, D. Yue, J. H. Park, Robust fault estimation design for discrete-time nonlinear systems via a modified fuzzy fault estimation observer, *ISA transactions* 73 (2018) 22–30. doi:10.1016/j.isatra.2017.12.007.
- [20] J. Han, H. Zhang, Y. Wang, X. Liu, Robust state/fault estimation and fault tolerant control for T–S fuzzy systems with sensor and actuator faults, *Journal of the Franklin Institute* 353 (2) (2016) 615–641. doi:10.1016/j.jfranklin.2015.12.009.
- [21] A. Benzaouia, A. El Hajjaji, A. Hmamed, R. Oubah, Fault tolerant saturated control for T–S fuzzy discrete-time systems with delays, *Nonlinear Analysis: Hybrid Systems* 18 (2015) 60–71. doi:10.1016/j.nahs.2015.06.003.
- [22] S.-J. Huang, G.-H. Yang, Fault tolerant controller design for T–S fuzzy systems with time-varying delay and actuator faults: A K-step fault-estimation approach, *IEEE Transactions on Fuzzy Systems* 22 (6) (2014) 1526–1540. doi:10.1109/TFUZZ.2014.2298053.

- [23] H. Zhang, J. Han, Y. Wang, X. Liu, Sensor fault estimation of switched  
445 fuzzy systems with unknown input, *IEEE Transactions on Fuzzy Systems*  
26 (3) (2017) 1114–1124. doi:10.1109/TFUZZ.2017.2704543.
- [24] D. Du, B. Jiang, P. Shi, Sensor fault estimation and compensation for time-  
delay switched systems, *International Journal of Systems Science* 43 (4)  
(2012) 629–640. doi:10.1080/00207721.2010.517867.
- 450 [25] S. Fu, J. Qiu, L. Chen, S. Mou, Adaptive fuzzy observer design  
for a class of switched nonlinear systems with actuator and sensor  
faults, *IEEE Transactions on Fuzzy Systems* 26 (6) (2018) 3730–3742.  
doi:10.1109/TFUZZ.2018.2848253.
- [26] L. Chen, S. Fu, Y. Zhao, M. Liu, J. Qiu, State and fault observer design  
455 for switched systems via an adaptive fuzzy approach, *IEEE Transactions*  
*on Fuzzy Systems* 28 (9) 2107–2118. doi:10.1109/TFUZZ.2019.2930485.
- [27] L. Chen, Y. Zhao, S. Fu, M. Liu, J. Qiu, Fault estimation observer design  
for descriptor switched systems with actuator and sensor failures, *IEEE*  
*Transactions on Circuits and Systems I: Regular Papers* 66 (2) (2018) 810–  
460 819. doi:10.1109/TCSI.2018.2871888.
- [28] H. Lens, J. Adamy, Observer based controller design for linear systems with  
input constraints, *IFAC Proceedings Volumes* 41 (2) (2008) 9916–9921.
- [29] H. Lens, Fast robust stabilization by saturating output feedback of un-  
certain linear systems with input constraints, in: *Proceedings of the 48th*  
465 *IEEE Conference on Decision and Control (CDC) held jointly with 2009*  
*28th Chinese Control Conference, IEEE, 2009*, pp. 6935–6940.
- [30] C.-H. Lien, Robust Observer-Based Control of Systems With state Per-  
turbations Via LMI Approach, *IEEE Transactions on Automatic Control*  
49 (8) (2004) 1365–1370. doi:10.1109/TAC.2004.832660.



- 470 [31] H. Kheloufi, A. Zemouche, F. Bedouhene, M. Boutayeb, On lmi conditions to design observer-based controllers for linear systems with parameter uncertainties, *Automatica* 49 (12) (2013) 3700–3704.
- [32] S. Wang, Y. Jiang, Comment on “on lmi conditions to design observer-based controllers for linear systems with parameter uncertainties [automatica 49 (2013) 3700–3704]”, *Automatica* 50 (10) (2014) 2732–2733.  
475
- [33] A. N. Atassi, H. K. Khalil, A Separation Principle for the Stabilization of a Class of Nonlinear Systems, *IEEE Transactions on Automatic Control* 44 (9) (1999) 1672–1687. doi:10.1109/9.788534.
- [34] D. Du, B. Jiang, P. Shi, Fault estimation and accommodation for switched systems with time-varying delay, *International Journal of Control Automation and Systems* 9 (2011) 442–451. doi:10.1007/s12555-011-0303-3.  
480
- [35] H. Yang, h. li, B. Jiang, V. Cocquempot, Fault tolerant control of switched systems: A generalized separation principle, *IEEE Transactions on Control Systems Technology* PP. doi:10.1109/TCST.2017.2785808.