



HAL
open science

**“ Assessing possible changes in a town’s buildings –
Fuzzy logic and 3D simulation Applied to the city of
Nice ”**

Christine Voiron-Canicio, Arteau Killian, Sant Florian, Tortorollo Nicolas

► **To cite this version:**

Christine Voiron-Canicio, Arteau Killian, Sant Florian, Tortorollo Nicolas. “ Assessing possible changes in a town’s buildings – Fuzzy logic and 3D simulation Applied to the city of Nice ”. 2013. hal-03555465

HAL Id: hal-03555465

<https://hal.science/hal-03555465v1>

Submitted on 3 Feb 2022

HAL is a multi-disciplinary open access archive for the deposit and dissemination of scientific research documents, whether they are published or not. The documents may come from teaching and research institutions in France or abroad, or from public or private research centers.

L’archive ouverte pluridisciplinaire **HAL**, est destinée au dépôt et à la diffusion de documents scientifiques de niveau recherche, publiés ou non, émanant des établissements d’enseignement et de recherche français ou étrangers, des laboratoires publics ou privés.

ASSESSING POSSIBLE CHANGES IN A TOWN'S BUILDINGS

Fuzzy logic and 3D simulation applied to the city of Nice

VOIRON-CANICIO

Christine

UNS, CNRS, ESPACE, UMR 7300, Nice, France.

voiron@unice.fr

ARTEAU

Killian

UNS, Nice, France

arteau.killian@etu.unice.fr

SANT

Florian

UNS, Nice, France

sant.florian@etu.unice.fr

TORTOROLLO

Nicolas

UNS, Nice, France

tn802793@etu.unice.fr

KEYWORDS

Change, Fuzzy logic, potential, 3D simulation, uncertainty

ABSTRACT

This paper presents an approach aiming to anticipate possible transformations of the overall built fabric of a town, analysed at building level. The research is applied to the city of Nice. A grid with 400m X 400m cells is applied over the commune's area. The field of study is made up of 163 cells concentrating half of the built-up area. The possibilities of transformation of buildings within a cell are estimated starting from hypotheses relating to four groups of variable: the structure of the built fabric, attractiveness linked to an infrastructure programme planned in the cell or nearby, the town's policy (urban renovation and climate plan) and residents' sensitivity to measures and practices in favour of sustainable development.

The method consists in estimating the potential of change of the built fabric in each cell by means of fuzzy logic. We use fuzzy Inference Systems to address the problem of future spatial changes. Data are either quantitative or qualitative, in view of the fact that it is often not possible to describe the environmental and social properties (e.g. architectural quality, social acceptance...) using objective indicators. Thereby, the spatial knowledge is described by semantic variables often affected by a high degree of inaccuracy and uncertainty, making fuzzy logic a suitable tool for expressing and processing this information.

The potential of change is assessed according to three scenarios: i) with no specific public policy in favour of sustainable development, ii) with an aggressive public policy against energy wasting in homes, iii) integrating the tendency of inhabitants to innovate and their level of sensitivity to levers set out by public policies.

The cells' potentials are mapped. Some of them are selected for carrying out simulations of plausible transformations of the built fabric, and visualising in 3D the changed aspects of façades in certain streets.

1. INTRODUCTION

When considering future transformations in the built fabric, certain points of view are generally favoured. Sectors most usually focused on are the town's emblematic sites, those with a heritage to enhance or preserve, and conversely, sectors in danger of being deteriorated. Prominence is given to areas concerned by renovation operations or new developments such as a tram line, a green network system or an eco-district. The urban project is integrated into the space in 3D and visualised in a more or less realistic way, with either fixed or dynamic representation depending on the modelling tools used. However, most of the time, the assessment of changes takes into account neither the whole of the town, nor ordinary changes which occur outside urban renovation operations.

Yet, the stakes of urban sustainability and adaptation to climate changes lie at the level of existing buildings as a whole, even ordinary and run down. Indeed, the answers expected can be found on two interrelated levels, the town's characteristic kind of urbanism – width and orientation of streets, green areas, high-albedo areas – and the housing and building level, which contributes for 43% to energy consumption in France and for 22% to greenhouse gas emission. Moreover, one important aspect of the adaptation of towns to climate change is usually overlooked. It concerns the transformation of the urban landscape as a whole, including the built-up area, public and private green areas, according to the adaptation measures taken by municipalities, according to the way residents respond to regulations and their propensity to follow recommendations and on the other hand, innovate.

This paper presents the first results of a preliminary work whose aim is threefold. First, assessing the possible future changes in the built fabric, considered at building level. The possible modifications of their appearance: height, façade colour, roof use, addition of plants, will be estimated in three different contexts: i) with no specific public policy in favour of sustainable development, ii) integrating the tendency of inhabitants to innovate and their level of sensitivity to sustainable development, iii) with an aggressive public policy against energy wasting in homes. Secondly, visualising in 3D the spatial changes. We assume that 3D simulations are useful to make the residents of a neighbourhood aware of the possible transformations of their living environment depending on different options of public policy, and help populations to adhere to the measures recommended. Such adherence requires information, awareness and appropriation of the recommended policy by these populations. It is greatly facilitated by the visualisation of the future urban landscape. Thirdly, testing the potential of fuzzy logic to deal with the uncertainty and the incompleteness of knowledge about the future changes. The research is applied to the city of Nice.

This paper is organised as follows. The section 2 expounds the constraints linked to the available geographical information and the methodological approach thereon. The third presents the processing protocol which has been adopted. The results obtained are analysed in section 4. Finally, section 5 proposes some conclusive reflection on the interest and limits of the research in progress and the perspectives opened by the study of the first results.

2. SPATIALISING POSSIBLE CHANGES ON AN INTRA-URBAN SCALE: GRIDE MAPPING AND FUZZY LOGIC

The possibilities of transformation of buildings are estimated starting from hypotheses relating to four groups of variable: the structure of the built fabric, attractiveness linked to an infrastructure programme planned in the cell or nearby, the town's policy (urban renovation

and climate plan) and residents' sensitivity to measures and practices in favour of sustainable development.

Grid mapping

The objective is to grasp intra-urban change on a fine scale from different types of data, either aggregated or punctual, some issued from databases, other from field studies. Thus, socio-economic data issued from INSEE's databases are available for the IRIS division, whereas information concerning the "Enquête-Ménage" the household survey of INSEE are issued from polls carried out taking into account another type of division. The energy loss levels put at our disposal by the Nice Côte d'Azur Metropolis are accessible for buildings, and so is information related to the nature of buildings shown in the IGN's BD Topo, and the field surveys on the buildings' architectural character, whereas the information concerning the number of subscribers to the "Vélobleu" service is obtained through subscribers' addresses.

It was therefore decided to create a regular grid to analyse all the variables considered; after trying out various sizes, a 400m x 400m cell size was chosen, that would be big enough to facilitate the numerous processing operations, and fine enough to reflect intra-urban differences. In this preliminary study, the potential change method is being applied on the dense built-up area located in the coastal plain, the two main valleys and the nearest the slopes of the amphitheater hill. The field of study is made up of 163 cells concentrating half of the built-up area.

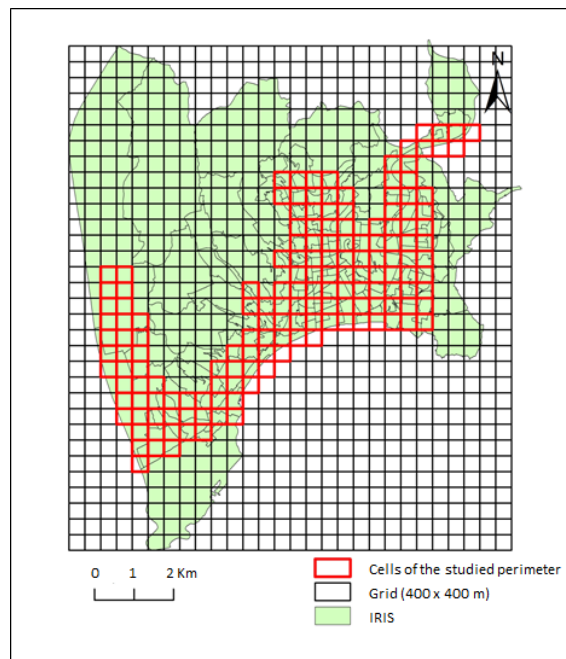

Fig.1: grid mapping and selected cells

Uncertainty and incompleteness of knowledge

The change is assessed starting from hypotheses based on 16 available variables selected using the bibliography existing on the matter, for their estimated contribution to the transformation of buildings. The main difficulty was to find relevant data at the micro level. We won't get into details on how the variables were finally selected. Five variables concern the structure of buildings in a cell: those built before 1975, which consume the most energy, the dilapidated

state of homes as resulting from the household survey, the presence of warehouses and craft activities that will disappear progressively from the central urban fabric, the buildings' architectural character – house with frieze, freestone block of flats which, because of their architectural quality, specificity and rarity, are highly sought-after, finally, the built-up area's heterogeneousness/complexity, with the hypothesis that the heterogeneousness of buildings provides opportunities for pulling down and rebuilding or raising them. Added to all this is the rate of energy loss in Nice municipality's buildings, resulting from thermography measurements which the municipality can use to start renovating public buildings and make the population aware of energy loss in homes.

The attractiveness exerted by an operation of urban development constitutes another ensemble of factors which contribute to modifying areas located in its vicinity. The N° 2 tram line and 10 other big urban projects in progress or planned have been taken into account.

Another group of variables tries to assess how aware of sustainable development are private stakeholders, and the propensity to change that may result. The variables have been retained, based on two surveys on sustainable lifestyles, a segmentation of the French population per social environment and a study of factors influencing sustainable consumption (Huber, 2012). Finally, height variables have been chosen depending on data available for each cell: the proportion of people over 55 in the population, the proportion of graduates, income, the proportion of holiday homes in their total number, the perception of the local environment and the choice of residence for environmental reasons, issued from answers to the Household Survey, subscription to the "Vélobleu" service, the percentage of votes for the Ecologists at the first round of the 2012 legislative election.

These variables, and more particularly the last group, are characterised by imprecision and uncertainty; uncertainty on the nature of the exact relation of certain variables to change, in regard to the elderly, the ecologist vote or the reluctance for change linked to the architectural character, for example, on the meaningfulness of answers to certain question in the household survey carried out on a very small number of people; uncertainty on the nature of buildings because of the high number of errors in the IGN's BD-Topo; uncertainty on the allocation of a single value which is supposed to characterise all the buildings in a cell. Imprecision adds to uncertainty in appreciating the stage of dilapidation of buildings or the area of influence of a development operation in terms of attractiveness.

Choosing fuzzy reasoning

Fuzzy sets theory (Zadeh, 1965) has been chosen as the formal frame of this research work because it was considered as better adapted than the probability theory to the representation of imprecise data and poor information. The probability theory, notably Bayesian, is too rich to faithfully express poor information reflecting partial ignorance. Moreover, fuzzy sets theory is much more flexible for modelling imprecise information, and it provides aggregation modes of the set type, which cannot be found in the usual probability models. Fuzzy reasoning allows to process this kind of information by defining the most plausible values of the parameters entered in the reasoning and admits that the same decision can be true and at the same, false with a certain degree of membership to each of these beliefs. Contrary to the probabilistic theory, the notion of degree of membership allows that the sum of the degrees of membership on the overall domain could not be automatically equal to 1. Thanks to this fuzzy membership principle, "such logic gives a highly appreciable flexibility to reasoning, thus making it possible to take imprecision and uncertainties into account." (Dernoncourt website). This type of reasoning is perfectly suited to the appreciation of most of the variables selected; for example, in a cell containing several buildings, the run-down state is not measured in terms of everything or nothing but buildings can be estimated as being 40% run-down, moderately run-down (60%) and not run-down (0%).

Contrary to Boolean logic which works on the base of everything (1) or nothing (0), fuzzy reasoning makes it possible to build sets in which the notion of membership varies between 0 and 1, and the same element can belong to several fuzzy subsets. A fuzzy set is defined by its membership function. A point in the universe, x , belongs to a fuzzy set, A , with a membership degree: $0 \leq \mu_A(x) \leq 1$. Figure 2 shows a triangle membership function (Grelier et al, 2007).

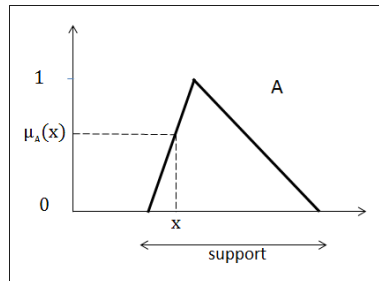

Fig.2: Fuzzy set described by a triangle membership function

3. PROCESSING PROTOCOLS

Fuzzy Inference Systems (FIS) are one of the most famous applications of fuzzy logic (Zadeh, 1965; Dubois and Prade, 2000; Bouchon-Meunier and Marsala, 2003). In this work, we use Fuzzy inference System to address the issues of assessing future changes. Processing was carried out using the FisPro 3.5 (Fuzzy inference system professional) software enabling to create fuzzy inference systems from numeric data (Guillaume, 2002). The fuzzy inference system is in three stages (Fig.3).

The first consists in fuzzifying, i.e. transforming a variable's numeric values into inputs with pre-defined degrees of membership to the various subsets. A fuzzy set made up of several subsets will be linked to each variable. In technical language, this corresponds to the division of the domain of definition, or support, of a variable in fuzzy subsets (Espinosa et al., 2000; Valente de Oliveira, 1999).

The second stage consists in defining the “inference engine” which includes all the fuzzy rules – like IF... THEN... linking the variables. There are two kinds of rules, those with a fuzzy conclusion, called Mamdani rules, and those with a crisp conclusion, called Takagi-Sugeno. The latter kind of rules was chosen bearing in mind that the aim is to obtain a crisp potential on each cell of the grid.

The last stage consists in defuzzifying using the results of the aggregation of rules with a view to calculating the potential output values.

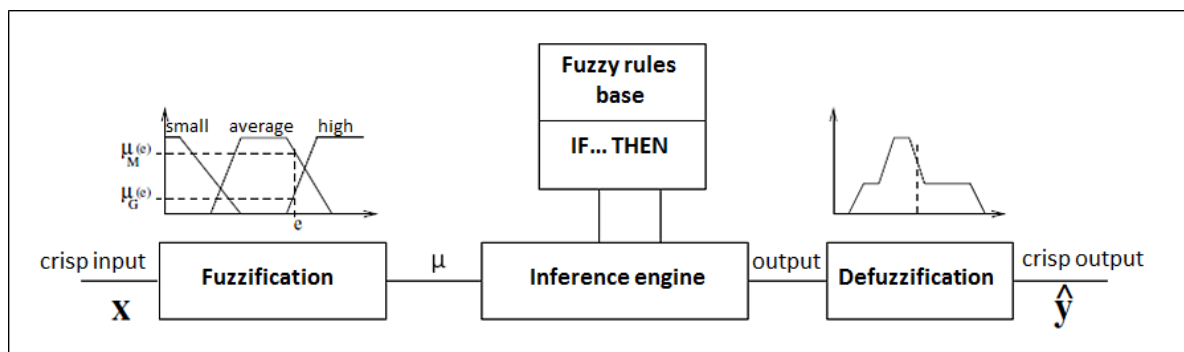

Fig.3: A fuzzy inference system (Guillaume, 2012)

Determining the fuzzy subsets

The fuzzy inference system is based on the partition of a variable's domain into fuzzy subsets. Different shapes of partition are possible: trapezoidal, triangular, sigmoidal shape. The subsets are delimited by threshold values depending on expert knowledge of the variable or the statistic distribution. Thresholds must meet a triple objective: be pertinent in relation with the hypotheses retained, take into account the specificities of certain variables, and be in a not too big number in order not to make the model too heavy because the number of inference rules is linked to the possibilities of crossing subsets. In the case of this study, the formation of subsets was based on the Jenks classification method. This form of discretisation is less arbitrary than equal interval or effective classes. The Jenks method is derived from natural breaks and minimises intra-class variance. Expert's points of view have been associated to the classification so as to validate or modify statistical classes.

The approach adopted is illustrated by some examples.

The buildings' run-down variable is discretised in three fuzzy subsets – low, medium, high – with a variance range of 10 to 45 (the highest run-down rate being 44.1 and the lowest, 10) (Fig.). Field information shows that grids with run-down % over 27% correspond to spaces characterised by significantly dilapidated housing. Therefore, the 27% threshold is chosen as the lower limit for the “high run-down rate” subset. The average is 21%, but we decided to start the “medium run-down rate” subset slightly lower, at 20%. Likewise, 20 is the threshold for the “high run-down rate” subset. The run-down rate is considered low under 13.

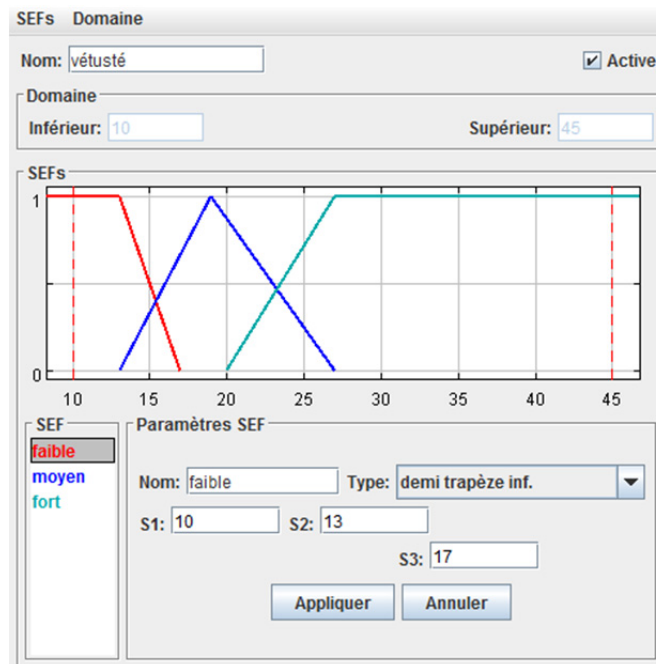

Fig.4: The fuzzy partition of the the buildings' run-down variable

The architectural character of buildings is a typical example of an imprecise and uncertain variable. If a building's character is a distinctive quality which makes it valuable, the notion is vague, the appreciation of the character is subjective and linked to particular contexts. However, in Nice buildings, certain types of architecture are undeniably more appreciated than others, are sought-after and therefore preserved from future transformations. As no inventory of this

characteristic architecture is available, the appraisal of the buildings' character was carried out via field surveys complemented by Google Earth and Street View, using a grid giving values to certain elements of a building, with different grades, and taking into account their proportion within each cell. The final scale of values goes from 0 to 10 (Fig.5). Two fuzzy subsets have been retained. Values over 9 concern spaces representative of Nice's architectural heritage. Under 2.5, the character is considered as very low. Between these two thresholds, the shape of the two curves illustrates the uncertainty regarding the appraisal of the architectural character.

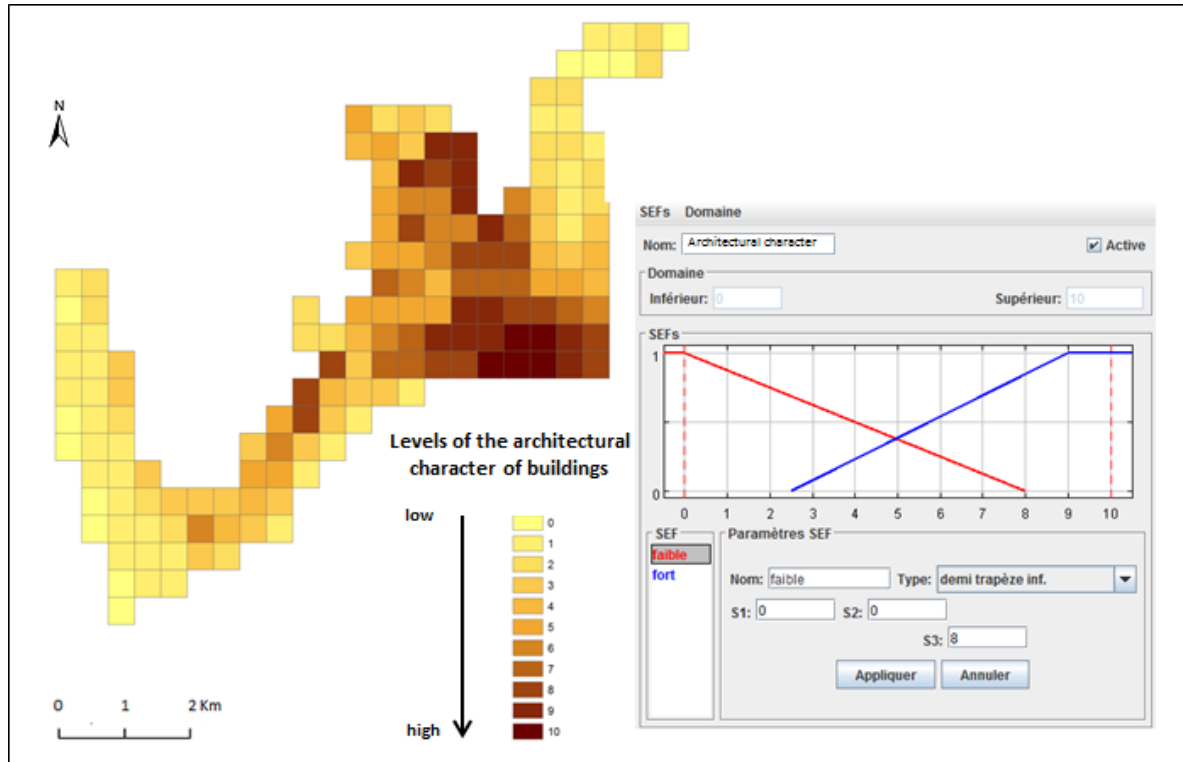

Fig.5: Levels of the architectural character of the buildings and the corresponding fuzzy subsets

The tram is one of the Nice town's infrastructure projects that contributes to change. Studies carried out on that subject show that the influence of tram stations on their environment spreads up to 500 m (Stambouli, 2005) and decreases with distance. The distance is considered from 3 buffers (0-200m, 200-350m, 350-500m). Three fuzzy subsets are taken: low, medium and high. For the low and high subsets, the membership degree is expressed via a sigmoidal curve instead of trapezoidal as previously.

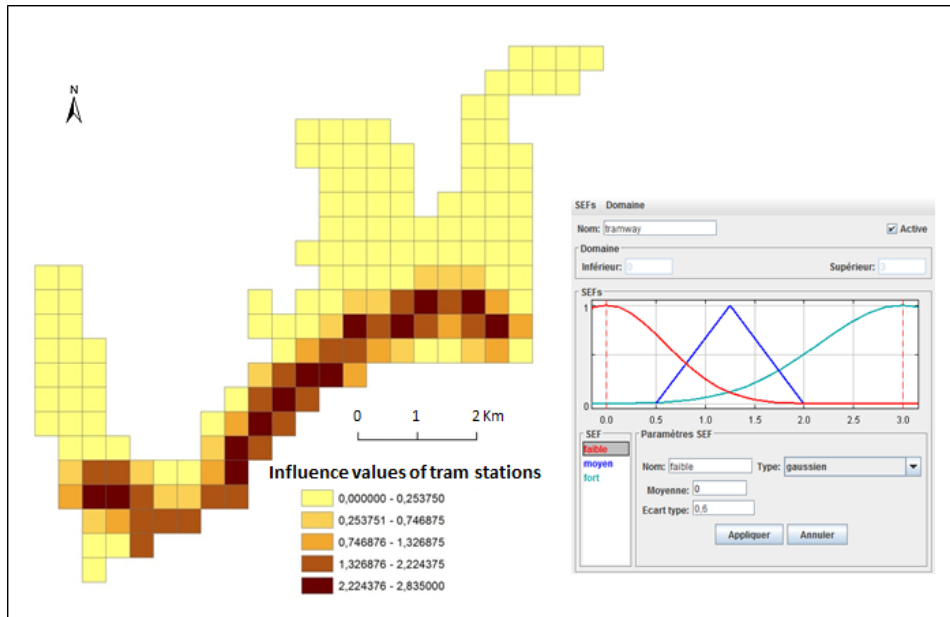

Fig.6: The fuzzy subsets of the influence of tram stations

Whereas Nice is a metropolis, it is also an important holiday centre, hence a high number of holiday homes. The map of the proportion of holiday homes per cell shows a gradient starting from the coast. The question is to assess whether this structure of the housing park is or not favourable to change. What is the leeway in a neighbourhood where over a quarter of homes are owned by people who occupy them only sporadically? The hypothesis is that owners of holiday homes do not behave in the same way as owners of main homes regarding energy loss, and that their propensity to renovate their home to adapt it to climate change is lower. Three fuzzy subsets limited by the 12% and 25% thresholds resulting from the Jenks classification have been retained. The first class is that with the highest number of cells. The range of membership to the intermediate subset which begins close to 0% is intentionally extended, in view of the uncertainty regarding the relation to change.

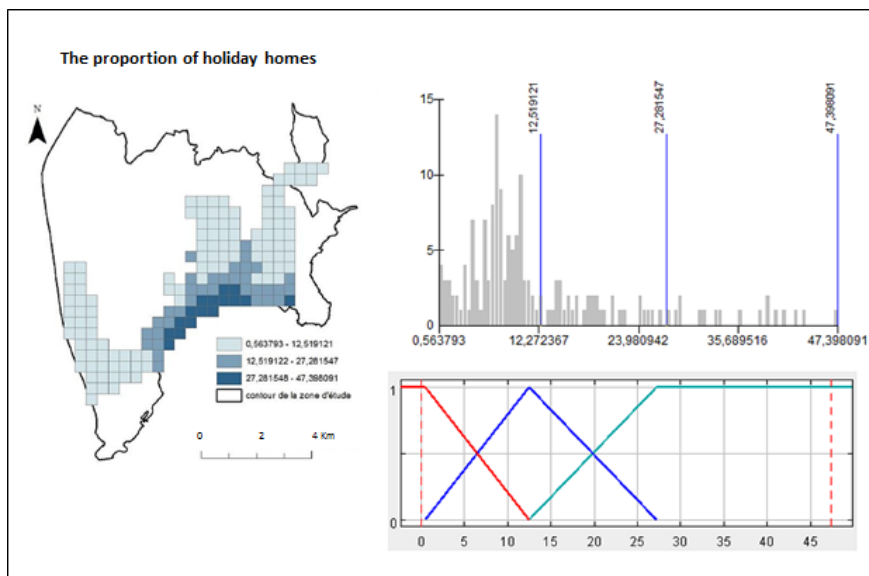

Fig.7: The fuzzy subsets of the proportion of holiday homes

The % of respondents to a question on the perception of the living environment in the household survey who say that they are dissatisfied (of house and neighbourhood) has been retained based on the hypothesis that a negative perception of the environment incites to change more than a positive one, while being aware of the fact that such change can lead to leaving that environment rather than trying to improve it. The map shows important spatial differentiations, with, notably, high rates of dissatisfied on the sea front as opposed to peripheral cells on the hills. Distribution is subdivided, using the Jenks methods, into three class breaks, 6%, 11% and 18%. However, because of the asymmetrical distribution and the difficulty to differentiate the subsets “low dissatisfaction” and “medium dissatisfaction”, the 13% threshold was preferred to the 11% in order to better bring out the highest values in the series for inferences and reduce the gradient of the intermediate subset (Fig.8).

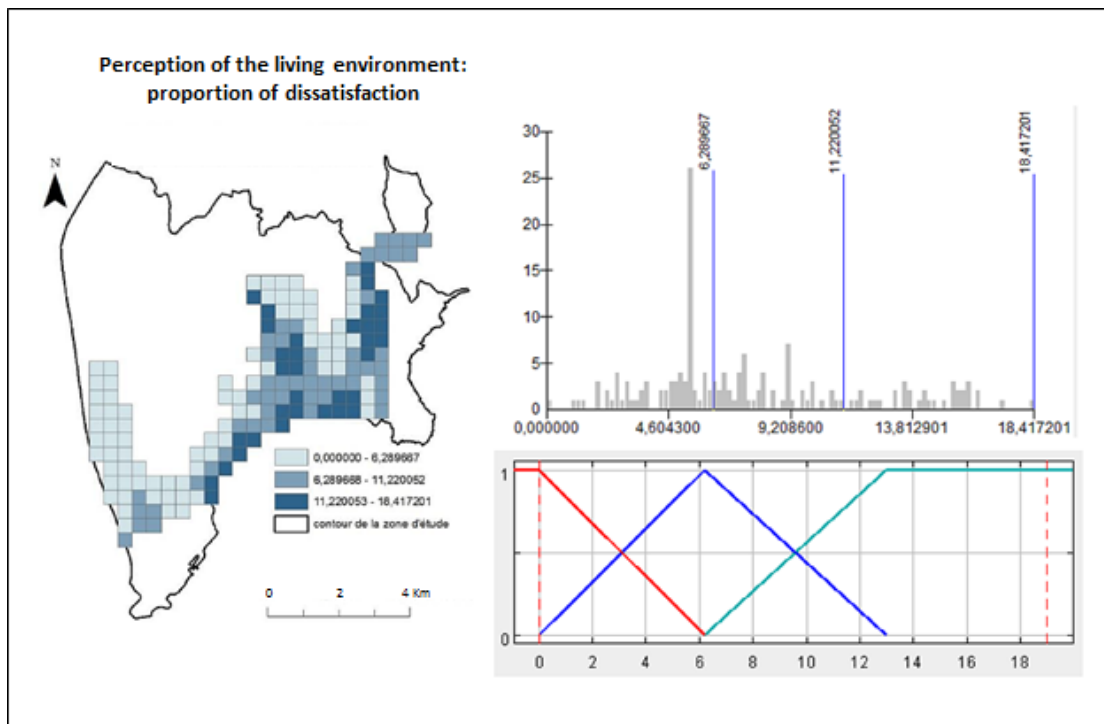

Fig.8: The fuzzy subsets of the proportion of dissatisfaction

Some variables require not to use the Jenks classification. Such is the case with “Vélobleu” subscribers in the population aged 14 to 59. To be taken into account, this variable must integrate the fact that using that service is related to the location of stations and to the topography. A low use of the service doesn’t necessarily reflects a reluctance of the people to use the service and, conversely, a high number of subscribers can be linked to the location of stations and the availability of public transport rather than to a strong motivation for the development of soft transport. Because of that uncertainty, the trapezium was preferred to the triangle to characterize the range of the intermediate subset. The 5% threshold was retained rather than the 6.7% because it corresponds to the % of French people using a bicycle for their everyday travels (Ministry of Ecology, sustainable Development and Energy, 2013) and indicates the integration of the service into the neighbourhood’s travelling habits (Fig. 9).

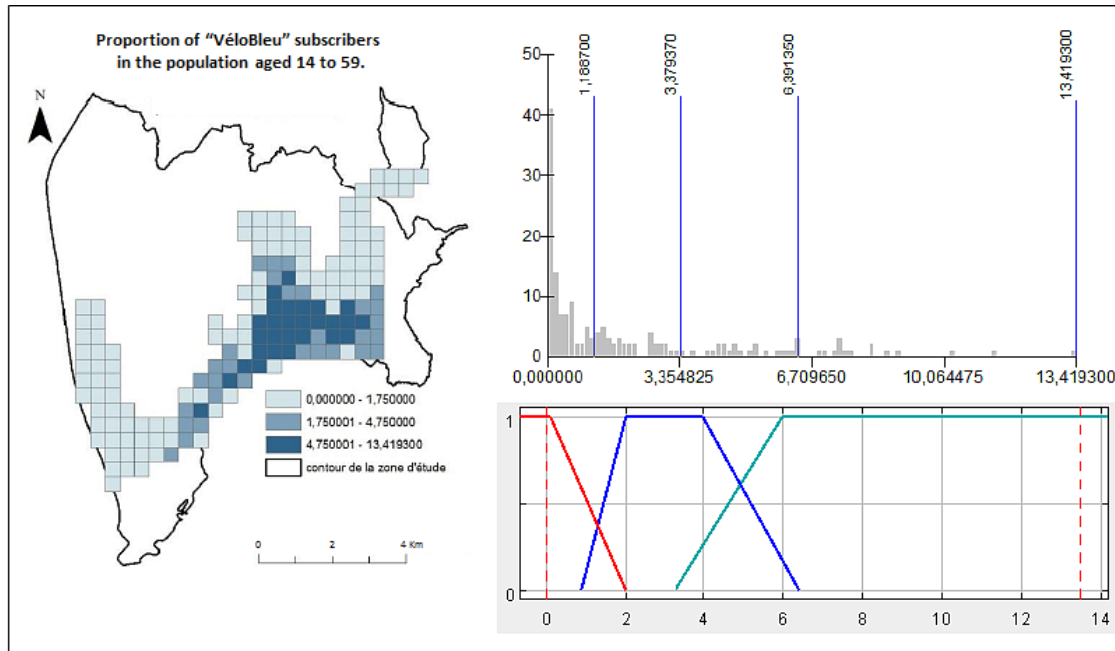

Fig.9: The fuzzy sets of the Velobleu subscribers

Determining the rules of inference »

There exist different kinds of fuzzy rules. The most common ones are called conjunctive rules and are used in Mamdani or Sugeno FIS. The underlying relationship between the input and output spaces is modeled using a conjunction operator (usually the minimum). They represent joint sets of possible input and output values. The rules can be generated in two ways – either by entering them one by one or by letting the programme cross all subsets. The Boolean operator linking the subsets of variables is the intersection, with a conclusion for each rule to be specified by the user, as well as an “expert weight”. Indeed, the software allows to weight the rules, and not the variables, depending on the grade of certainty/uncertainty one has on the chain of relations. The defuzzyfying method retained is of the Sugeno type, that enables to take an average of inferences depending on the weighting of rules, and the output chosen, called crisp, is a numeral value representing the potential of change.

The rule weighting method is more or less complex depending on the variable families. Thus, the architectural character is judged as determining for the built structure, the hypothesis being that if the character is high the possibility of change is low, and the potential is automatically valued at 0.1. On the other hand, in the case of variable families reflecting the social propensity to change, the rules are organised into a hierarchy. Because of the complexity of relations, the organisation cannot be linear, but into a hierarchy instead. The first grade corresponding to the trinomial proportion of “over-55/proportion of graduates/income” has been retained (in hierarchical order) because it was considered as being the most decisive in regard to possible changes, according to the bibliography. The premise that a high percentage of over-55 restrains significantly the social propensity to change is adopted. The “income” variable is the catalyst of propensity to change. However, high income is both synonymous with easy access to innovative equipment or self-financed improvement, and with energy-guzzling behaviour and a certain resistance to constraining measures such as the carbon tax. This first grade constitutes a common base for all the inferences whose relations are well defined thus limiting the risks of

differences due to ignorance. No rule has been de-activated so as to retain the field of possibility as a whole. The second grade encompasses the proportion of holiday homes, the perception of the environment and ecologist votes. Holiday homes form the highest constraint of that second grade which, here, has been implicitly correlated with the environmental perception. Ecologist votes follow to weight the relation depending on the first set of relations. The last grade is made up of 2 variables: the use of the “Vélobleu” service and the weight of environmental considerations in the choice of a home – closely linked to the second grade’s relations and built from less solid samples.

4. RESULTS

Scenario 1, “business as usual”, brings out the most plausible future change areas in regard to the structure of built-up areas and urban projects in progress. Two areas appear as the most prone to change, the lower Var valley in the west, and the Saint Roch and Pasteur districts in the Paillon valley in the east (Fig. 10). Both areas are characterised by a high proportion of old buildings, a medium yet significant run-down rate, and little architectural character. Moreover, they are concerned by urban development project that should impulse change. Conversely, the coastal plain and hillsides appear to be less conducive to change. The only exception is the Gare du Sud neighbourhood which has one of the highest change potentials.

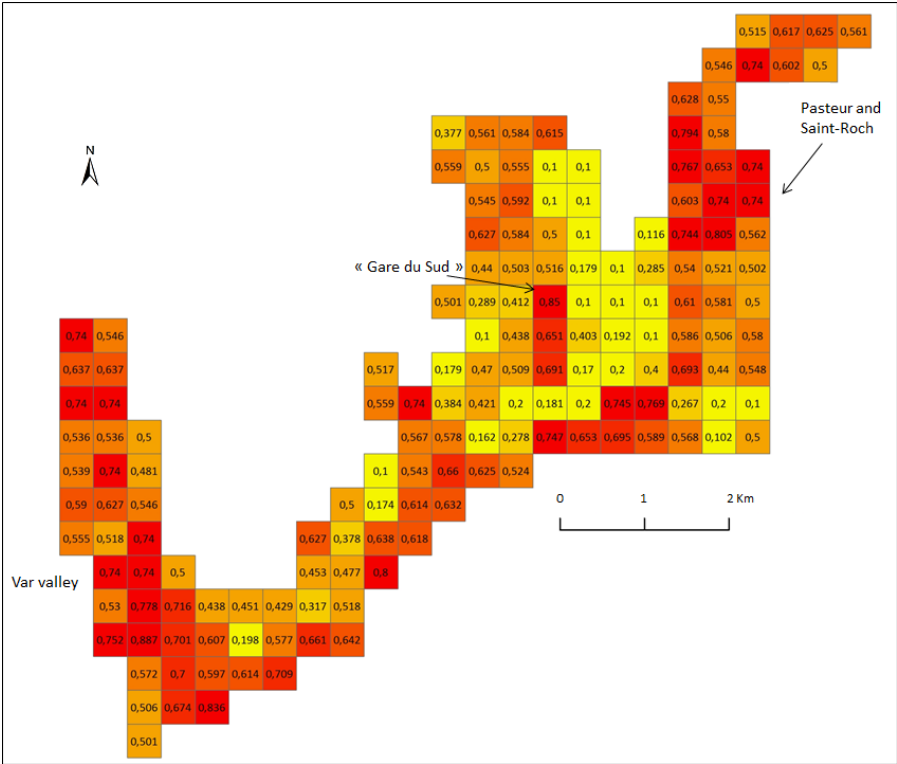

Fig.10: Final potential values in regard to the structure of built-up areas and urban projects

Scenario 2 postulates that the social propensity to change is as determining a factor as urban development or restructuring operations. The map of the social propensity to transform buildings brings forward two areas already identified as conducive to change – the west and the east. In the central part, the contrast is less clear but a zone with a highest propensity than coastal sectors emerges – it is located at the foot of the Cimiez hill and is characterised by a

population mix (Fig11). Crossing the potentials of change linked to the existing buildings and to the social propensity to change reinforces certain areas: the south of the Var valley, for example, and also brings out new areas on the coast (Fig.12).

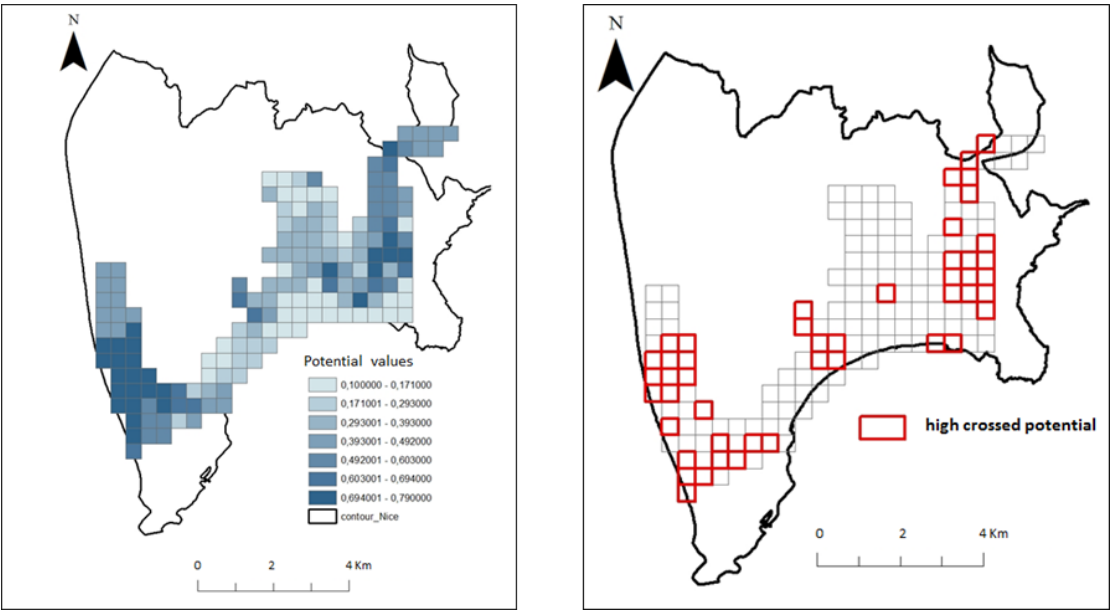

Fig.11: Social propensity to change. & Fig.12: Crossed potentials (buildings and social propensity)

Scenario 3 is based on Nice municipality’s voluntarist policy advocating a “green and sustainable town”. The simulation crosses the Nice municipality’s thermographic database with the potential derived from Scenario 1, in order to take into account the trend consisting in planting vegetation on roofs, the town’s “nature” plan and the reduction of energy loss. There are two kinds of results. On the one hand detection of areas where interventions are most needed and which are more sensitive to change; the cells’ potentials are mapped and some of them are selected for carrying out simulations of plausible transformations of the built fabric (Fig.13). On the other hand, the visual impacts of the transformations of the buildings aspect are simulated. The changed aspects of roofs and façades in certain streets are visualised in 3D (Fig.14 and 15).

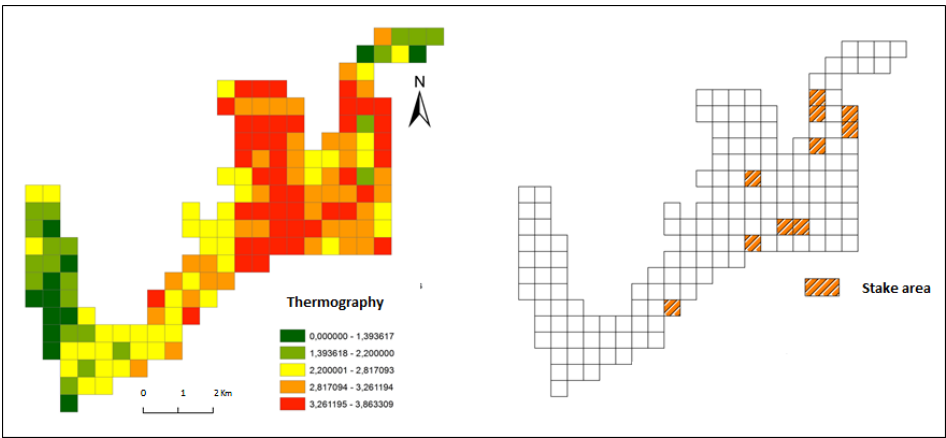

Fig.13: Detection of areas where interventions are most needed regarding reduction of energy loss

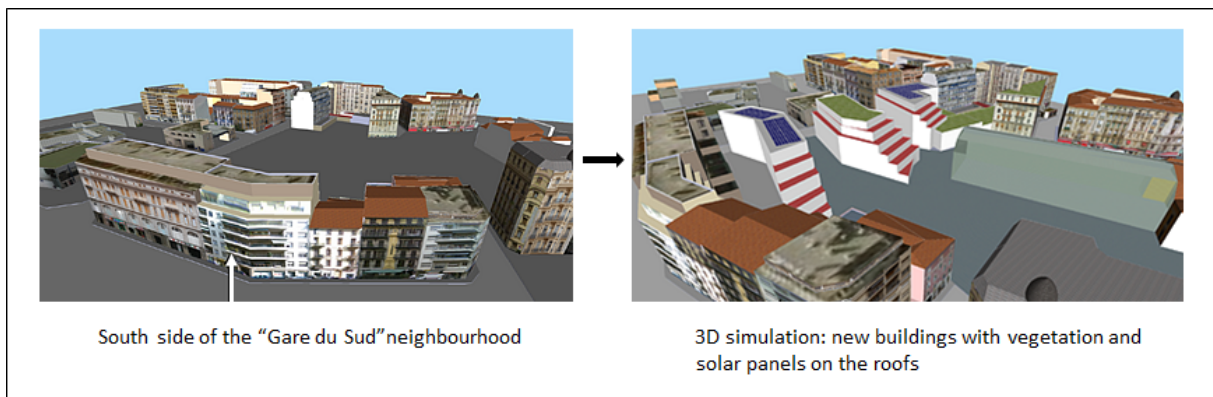

Fig.14: 3D simulation: visualising and matching urban transformations



Fig.15: 3D views of green roofs

5. CONCLUSION AND DISCUSSION

This article expounds the very first results of a research work dealing with issues of uncertainty related to the urban future changes. From the beginning, researchers have been faced with absent, incomplete and hardly reliable information, and have been forced to restrain the choice of variables to the available information, to heterogeneous spatial levels and to a lack of scientific literature on the subject.

The possibility theory has been chosen as the formal frame of this research work because it was considered as better adapted than the probability theory to the representation of imprecise data and poor information. Fuzzy reasoning allows to process this kind of information by defining the most plausible values of the parameters entered in the reasoning. This work highlights the potential of Fuzzy inference system to address issues of geopropective, making it possible to outline future plausible transformations of the built fabric. The first scenario, based on the characteristics of the building structure and on the infrastructure initiated by the municipality of Nice, has brought out areas where the change potential was not or hardly envisaged. In comparison, the second scenario brought forward the social dimension of change.

The third scenario, with an operational aim, made it possible to detect sensitive areas in terms of energy loss and which are the most favourable to renovation. The 3D simulation of the resulting transformations adds the visual dimension of change, which is rarely associated with geoproductive modelling.

Nevertheless, this research is still in progress and several kinds of questionings emerge. The first concern the reliability of the hypotheses. The postulate relating to the reluctance of older people for change can be put into question. The youngsters can also resist change, can be in search of more traditional values (Hubert et al., 2012) or sensitive to regional identities or even have regionalist leanings (Félonneau et al., 2008). Therefore, it is important to introduce different points of view on the hypotheses, and the method allows it. The variables that were processed were those available, for lack of having other information such as the point of view of neighbourhood committees and associations, and the location of photovoltaic panels. The analysis is conditioned by the grid size and positioning, there remains to determine how sensitive these results are to those two parameters.

6. BIBLIOGRAPHY

Bouchon-Meunier B. and Marsala C., 2003. *Logique floue, principes, aide à la décision*. Lavoisier.

Dernoncourt F., Introduction à la logique floue :

<http://franck-dernoncourt.developpez.com/tutoriels/algo/introduction-logique-floue>

Dubois D., Prade H., 2000. *Fundamentals of fuzzy sets*. Kluwer Academic Publishers.

Espinosa J., Vandewalle J., 2000. Constructing fuzzy models with linguistic integrity from numerical data-afreli algorithm. *IEEE Transactions on Fuzzy Systems*, 8 (5), 591-600.

Felonneau M.L. et al., 2008. « Spatialisation identitaire chez les adolescents et les jeunes adultes : le cas du Pays basque français ». *Les Cahiers internationaux de psychologie sociale* 4/2008, 80, 59-71

Grelier M., Guillaume S., Tisseyre B., Scholasch T., 2007. « Precision viticulture data analysis using fuzzy inference systems ». *J. Int. Sci. Vigne Vin*, 2007, 41, n°1, 19-31

Guillaume S., Charnomordic B., 2012. Fuzzy inference systems: An integrated modeling environment for collaboration between expert knowledge and data using FisPro. *Expert Systems with Applications* 39 (2012) 8744–8755

Guillaume S., Charnomordic B., 2004. Generating an interpretable family of fuzzy partitions. *IEEE Transactions on Fuzzy Systems*, 12 (3), 324-335.

Guillaume S., Charnomordic B., Lablée J.-L., 2002. *Fispro: An open source portable software for fuzzy inference systems*. <http://www.inra.fr/Internet/Departements/MIA/M/fispro>

Ministère de l'Écologie du développement durable et de l'énergie, 2013. Zoom sur la politique vélo. <http://www.developpement-durable.gouv.fr/La-pratique-du-velo-en-France.html>. Consulté en mai 2013.

Stambouli, J., 2005. « Les territoires du tramway moderne : de la ligne à la ville durable ». *Développement durable et Territoires, dossier 4*

Uber A., Girard S., Le Marre P., 2012. «Vers des modes de vie durable». *Futuribles*, 392, 43-60

Valente de Oliveira J., 1999. Semantic constraints for membership functions optimization. *IEEE Transactions on Systems, Man and Cybernetics. Part A* 29 (1), 128-138.

Zadeh L.A., 1965. Fuzzy sets. *Information and Control*, 8, 338-353.