



UNIVERSITÉ D'ORLÉANS

Institut des Sciences de la Terre d'Orléans



High temperature in-situ emissivity study of basaltic dry magmas

J. Biren¹, L. del Campo², L. Cosson², H. Li¹, A. Slodczyk^{1,2}, J. Andújar¹

¹ISTO, UMR 7327, Université d'Orléans-CNRS-BRGM, 45071 Orléans, France

²CEMHTI UPR 3079, CNRS-Université Orléans, 45071 Orléans, France

NH6.1 – 07 May 2020 – 14:00-15:45

Context

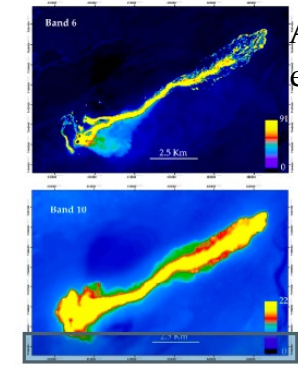
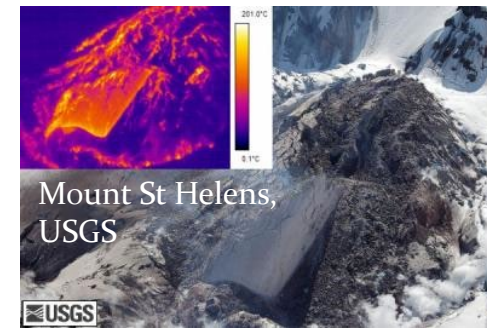
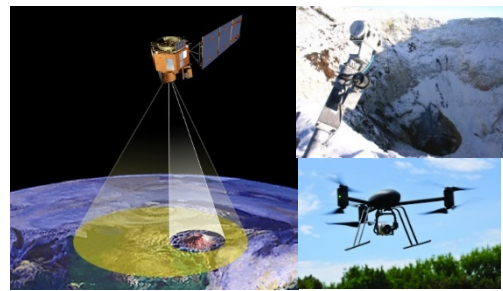

Aufaristama et al. (2018)

- Volcanic eruptions are regularly monitored by remote sensing (RS).
- The accuracy of these RS techniques depends on crucial parameters such as **spectral emissivity (ϵ)**.
- In literature, ϵ is mostly considered constant for a given rock family or is estimated indirectly from Reflectance data (Harris 2013); for example $\epsilon = 1$ or 0.95 in the case of basalts.
- To date, only a few studies have measured laboratory in-situ ϵ at relevant magmatic T: Lee et al. (2013), Rogic et al. (2019a, b), Ramsey et al. (2019), and Thompson and Ramsey (2020)
 - ϵ is measured in limited spectral range: 5-16 μm (2000-625 cm^{-1}).
 - Most data are acquired in limited temperature range: i.e. at $T \leq$ glass transition. Only in Lee et al. (2013), T reaches 1400 $^{\circ}\text{C}$.
 - Results show that ϵ decreases with T in TIR range (8-14 μm)
 - **Emissivity of melt (ϵ_{hot}) < Emissivity of crystallised lava (ϵ_{crust})**.
- These determined ϵ values do not allow to obtain reliable modeling results → overestimation of radiant flux measured by RS and modelled distance-to-run of lava.

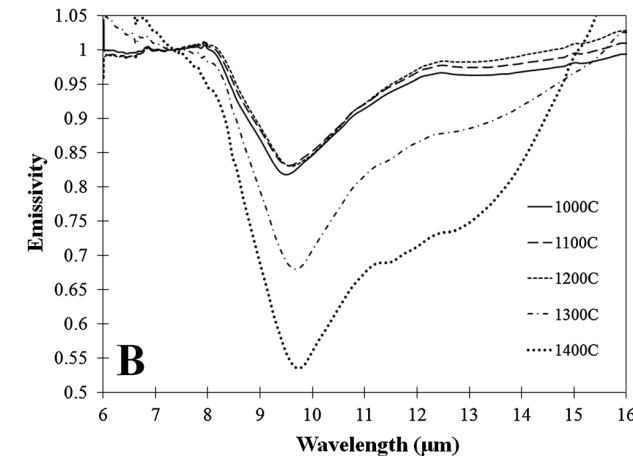

Ex from Lee et al. (2013):
 ϵ decreases with T in TIR range.

To solve this issue: **high temperature and broad spectral range ϵ data are necessary!**

This work is aimed at determining the in-situ Emissivity response of three basalts over a range of magmatic temperatures (up to 1300 K) in the TIR-MIR-SWIR spectral regions (500-8 000 cm^{-1}).

In-situ emissivity measurements (De Sousa Meneses et al. 2015)



Apparatus developed at CEMHTI (Orléans, France):

- two FTIR spectrometers (Bruker 80v and 70) + CO₂ Coherent K500 laser + sample chamber
 - Sample chamber: turntable with sample holder + Black Body furnace (Pyrox PY8)
- Wide spectral range 20-18 000 cm⁻¹, NIR-MIR-TIR →
- High Temperature range from ambient to 2000 °C
- Solid cylindrical glass samples of 1.5 x 10 φ mm

Spectrometer	Spectral range (cm ⁻¹)	Beam splitter	Detector
Vertex 80v	[20, 600]	Multilayer	Bolometer
Vertex 80v	[380, 5000]	Ge/KBr	DLaTGS/KBr
Vertex 70	[380, 5000]	Ge/KBr	DLaTGS/KBr
Vertex 70	[3800, 10,000]	Vis/CaF ₂	InGaAs
Vertex 70	[9000, 18,000]	Vis/CaF ₂	Si-diode

$$E(\sigma, T, \theta) = \frac{L(\sigma, T, \theta)}{L^0(\sigma, T)}$$

Emissivity is determined using direct method (see Eq. enclosed), method validated for phonolites in Li PhD thesis (2018).

Temperature is calculated via the Christiansen wavenumber (i.e. where ε =1) with uncertainty ~1 %.

Bruker Vertex 70 (FT-IR)

Bruker Vertex 80v (FT-IR)

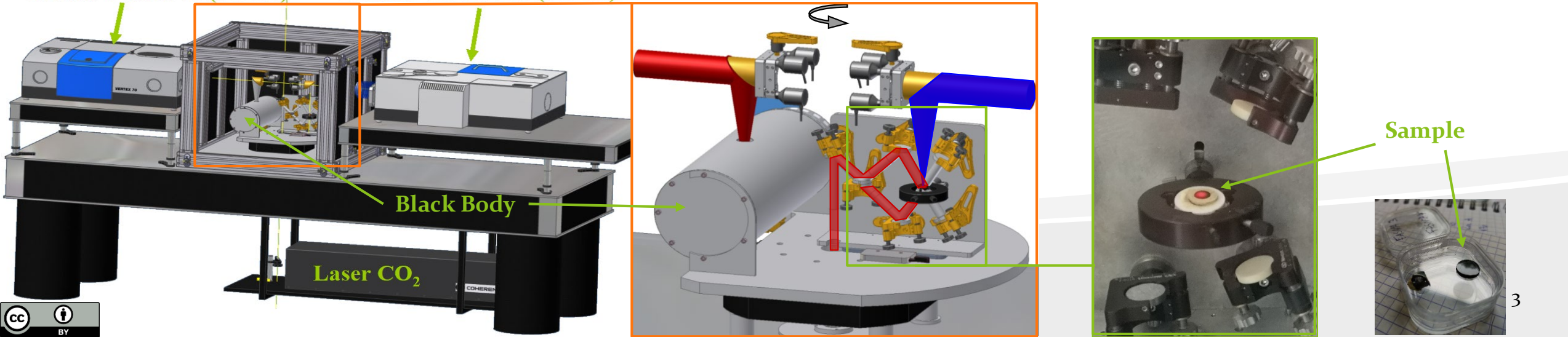

Glass Samples



Holuhraun
2014-2015,
Bardarbunga
volcano
(Iceland)



El Teide
(Teneriffe,
Canary
Island)
(credit: M.
Jimenez)

- **Basalt: MORB** (Juan de Fuca, provided by Prouteau et al. 2001)
 - 48.8 wt. % SiO₂ + 3.0 wt. % Alkali
- **Basalt: 2014-2015 Holuhraun** (Bardarbunga, provided by U. Iceland-A. Hoskuldson)
 - 46.9 wt. % SiO₂ + 2.6 wt. % Alkali
- **Basanite: 1704-1705 Fasnja** (Tenerife Canary Island)
 - 43.2 wt. % SiO₂ + 5.1 wt. % Alkali

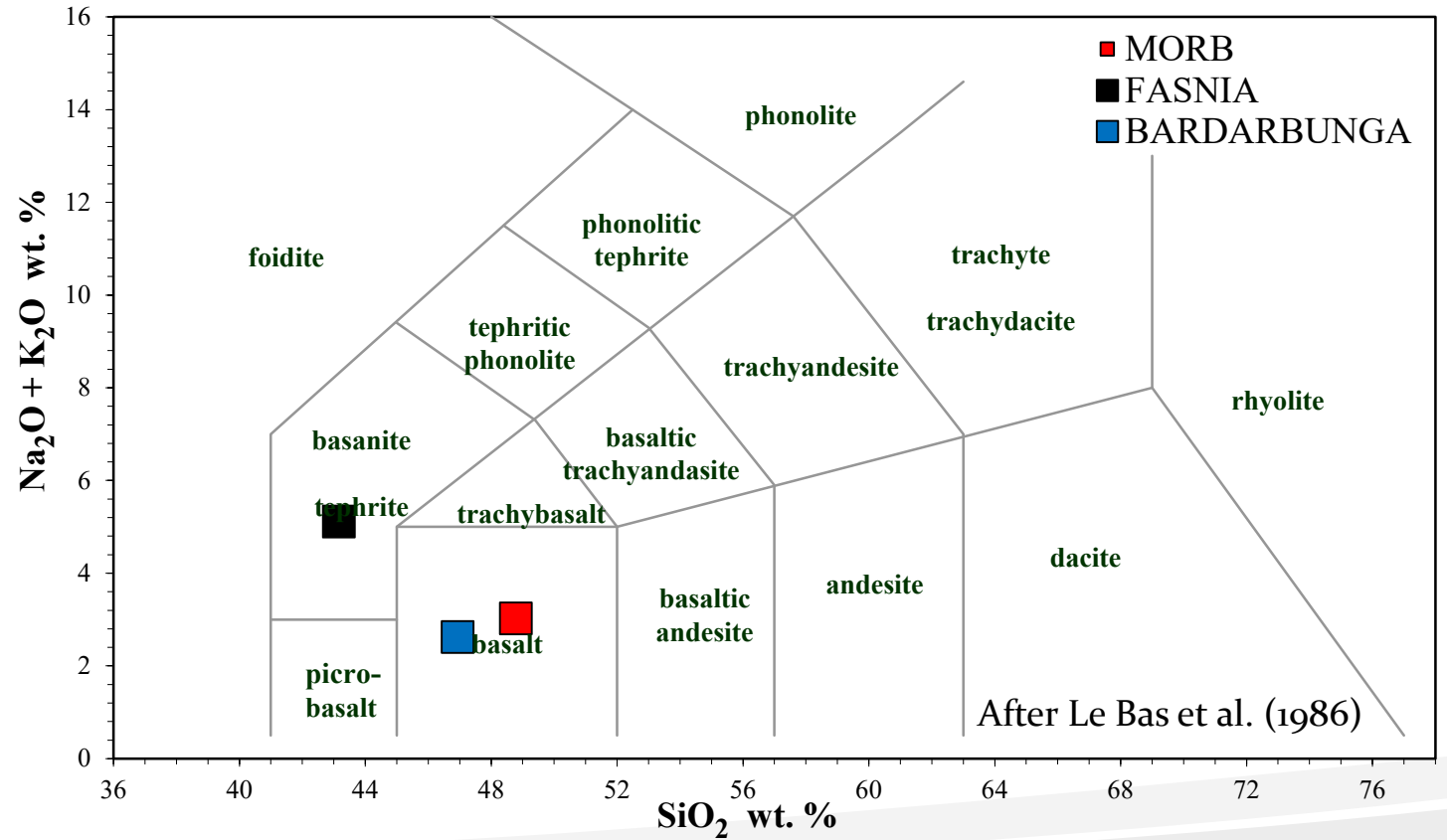

Textural, chemical and structural characterisation before and after IR measurement: SEM, EMPA and μ Raman spectroscopy.

Results – Thermal emissivity of MORB (Juan de Fuca)

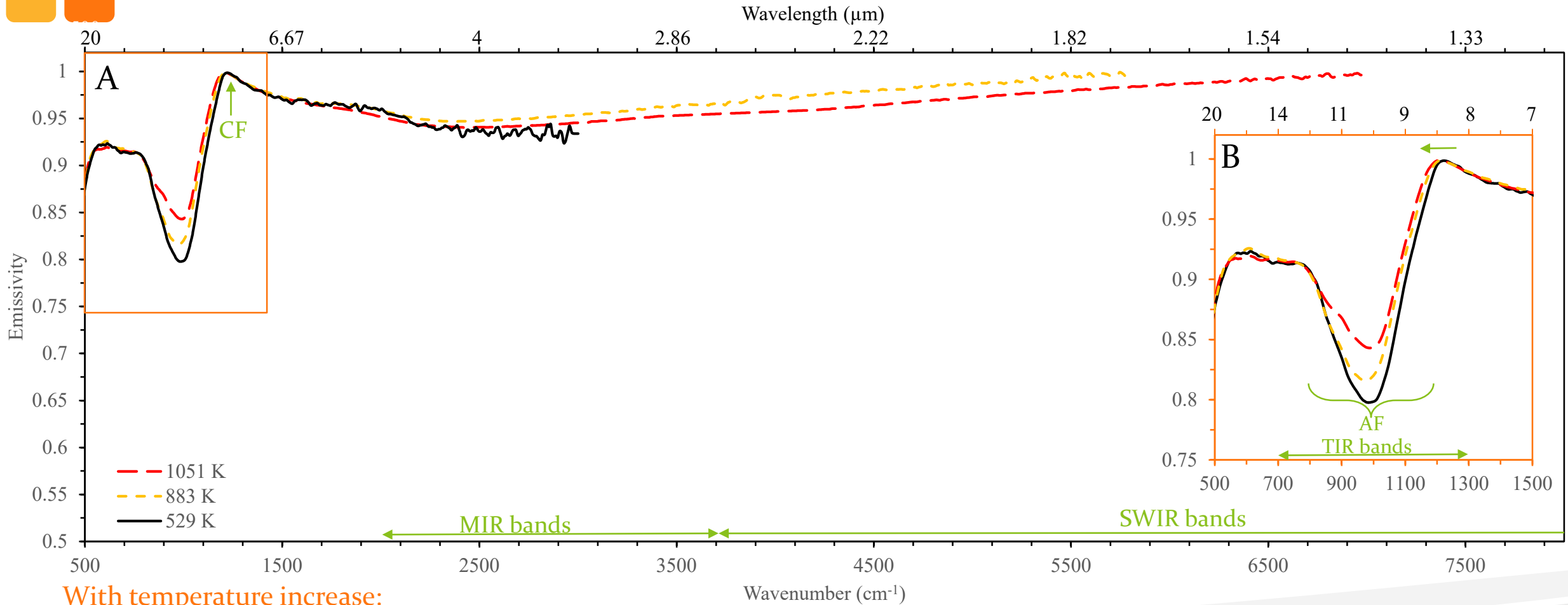

With temperature increase:

- ϵ increases in TIR range from 0.80 to 0.85 at 10 μm .
- Absorption feature (AF) \rightarrow vibrations of silicate network.
- In MIR and SWIR; ϵ shows very high, constant values (~ 0.95), close to a black body behavior.
- The Christiansen feature (CF, around 1230 cm^{-1}) shifts towards lower wavenumber.



Results –thermal emissivity of Basalt (Bardarbunga)

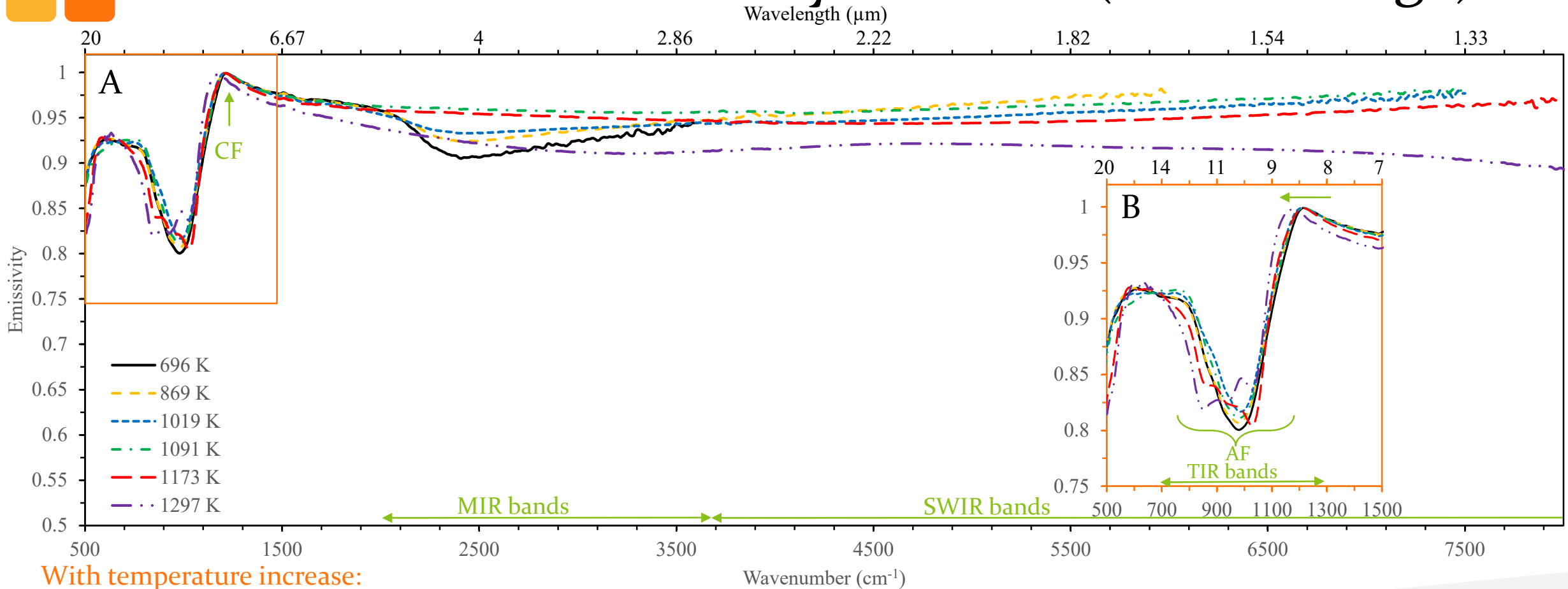

With temperature increase:

- ϵ increases in TIR range from 0.80 to 0.84 at 10 μm .
- ϵ almost constant (~ 0.95) in MIR and SWIR until 1173 K. With further T increase, ϵ slightly decreases to 0.90.
- Modifications of Absorption feature (AF) at $T > 1173$ K and shift of Christiansen feature (CF, around 1215 cm^{-1}) to lower wavenumber. \rightarrow structural reorganization of glass network.



Results – Thermal emissivity of Basanite (Fasnia)

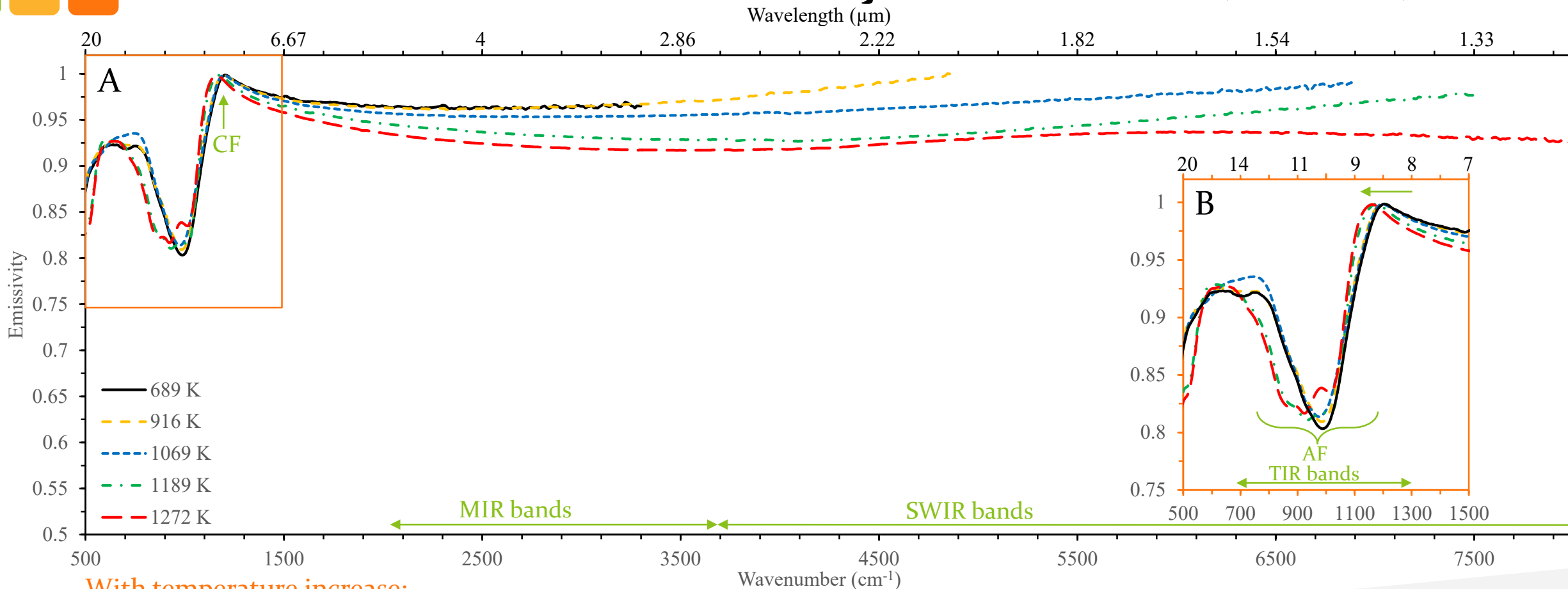

With temperature increase:

- ϵ increases in TIR range from 0.80 to 0.84 at 10 μm .
- ϵ almost constant (~ 0.95) in MIR and SWIR until 1069 K, With further T increase, ϵ slightly decreases to 0.91.
- Modifications of Absorption feature (AF) at $T > 1069$ K and shift of Christiansen feature (CF, around 1210 cm^{-1}) to lower wavenumber \rightarrow structural reorganization of glass network.

Application – Emissivity for SWIR/TIR bands

MORB (Juan de Fuca)

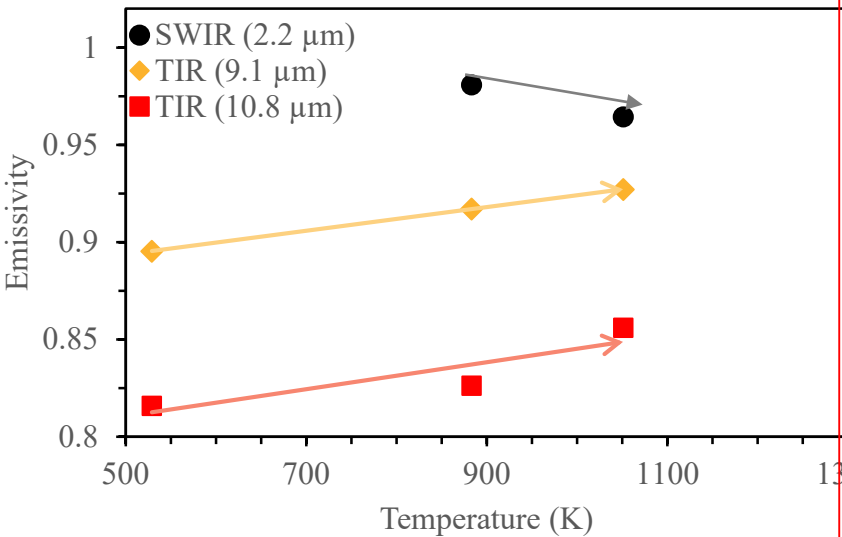

Basanite (Fasnia)

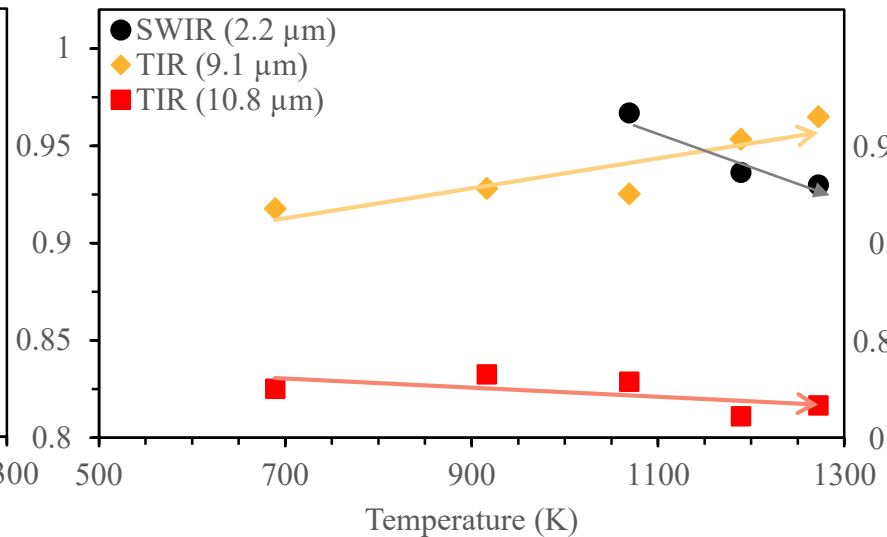

Basalt (Bardarbunga)

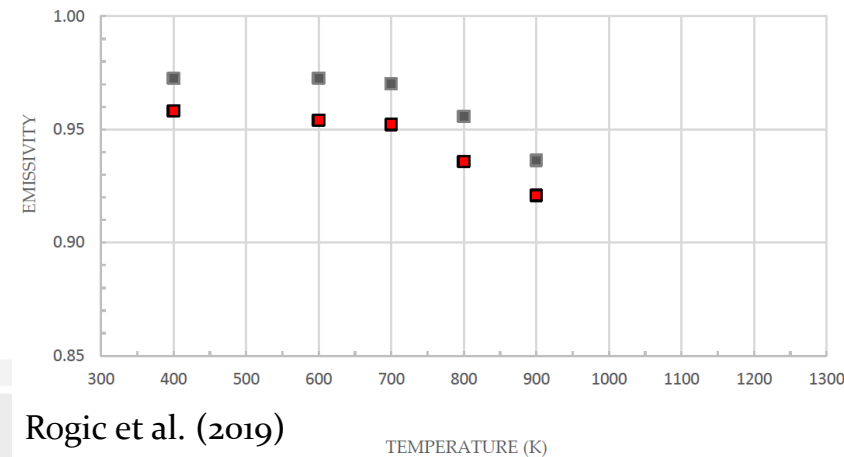
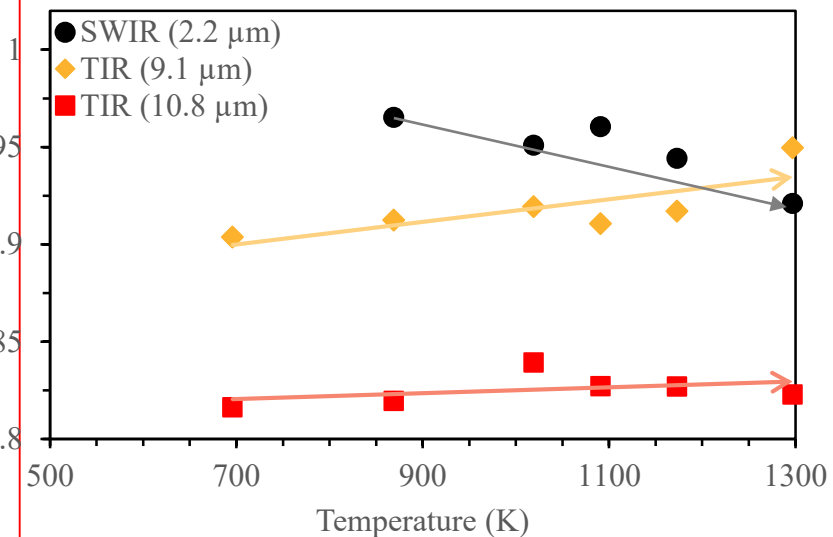

- $\epsilon_{10.8\mu\text{m}} < \epsilon_{9.1\mu\text{m}} < \epsilon_{2.2\mu\text{m}}$, except at >1190 K.

- Similar behavior between basalts and basanite.

- ϵ_{SWIR} decreases with T (from 0.97 at ~1100 K to 0.92 at ~1300 K).

- ϵ values remain high (>0.8) and slightly increases with T (light green arrows).

- MORB composition approaches Etna composition (Rogic et al. 2019).

- $\epsilon_{\text{MORB}} < \epsilon_{\text{Etna}}$ at 600, 700 and 900 K.

- at 10.8 μm: ϵ increases or remains constant with T (this study) VS ϵ decreases with T (Rogic et al. 2019).

Discussion



Our study

Overall ϵ increase with T in TIR in all basalt samples.

ϵ shows almost a blackbody behavior in MIR and SWIR.

Absorption feature (8.5-12 μm): vibration variations of Si/Al/Fe silicate tetrahedra in Restsrahlen bands = Rearrangement in the disordered glass structure at highest T.

Overall ϵ values remains above 0.80 within all conditions applied.

In TIR: Emissivity of melt (ϵ_{hot}) > Emissivity of crystallised lava (ϵ_{crust}).

Basalts and basanite present similar ϵ behavior.

Litterature

Overall ϵ decrease with T in TIR in all studies (Lee et al. (2013), Rogic et al. (2019a, b), Ramsey et al. (2019), and Thompson and Ramsey (2020)).

No data in MIR and SWIR.

Absorption feature between 8.5-12 μm .

ϵ values are variable:

- Ramsey et al. (2019): $\epsilon_{\text{hot}}(0.60) < \epsilon_{\text{crust}}(0.95)$
- Lee et al. (2013): ϵ from 0.50 to anomalous values >1 between 6-16 μm .
- Rogic et al. (2019a, b): ϵ above 0.90

Rogic et al. (2019a, b): ϵ behavior of Etna basalts differs from the basalts presented here.

Lee et al. (2013): large ϵ variations at $T > 1200$ K.



Conclusion



- Emissivity is dependent of:
 - Composition
 - Wavelength
 - Temperature
- Emissivity increases with temperature in TIR, and remains constant, close to blackbody behavior, in MIR and SWIR until 1069 K for Fasnja and 1091 K for Bardarbunga. Then decreases in T range where structural modifications were detected.
- Basanite and basalts have similar emission behaviours, similar to Fe-rich phonolites (Li PhD (2018), Li et al. in prep).
- In-situ Laboratory ϵ must be compared to field data.

Improvements on ϵ uncertainty will enhance our capacity to better constrain kinetic T and surface radiance from RS and accurately model lava flows with appropriate rheological evolution; information that are crucial to improve hazard assessment in volcanic systems.

Thank you for reading me...



25/10/19 Piton
de la Fournaise
(credit: R.
Bouhet)

Acknowledgements:

This PhD thesis is funded by French Region "Centre" and supported by Labex Voltaire, Planex and by CNRS/INSU TelluS program with RADIABAR project. A. Hoskuldsson, G. Pouteau, are kindly thanked for providing the starting materials for this study. M. Aufaristama is thanked for scientific discussions. JA thanks IGN from Canary Islands for giving support in field campaigns.

References:

- **Aufaristama, M., et al. 2018**, *Remote Sensing*, 10, 151.
- **De Sousa Meneses, D., et al. 2015**, *Infrared Physics & Technology*, 69, 96-101.
- **Harris, A.J.L.** *Cambridge University Press: Cambridge, UK, 2013*. Volume 9780521859, ISBN 9781139029346.
- **Le Bas, M. J., et al. 1986**, *Journal of Petrology*, 27, 745-750.
- **Lee, R.J., et al. 2013**, *Journal of Geophysical Research of Solid Earth* 118, 1968–1983.
- **Li, H., 2018**, *PhD thesis*, Université d'Orléans.
- **Prouteau, G., et al. 2001**, *Nature*, 410, 197–200.
- **Ramsey, M., et al. 2019**, *Annals of Geophysics*. 61.
- **Rogic, N., et al. 2019**, *Remote Sensing*. 11, 662.
- **Rogic, N., et al. 2019**, *Remote Sensing*. 11, 3032.
- **Thompson, J.O., et al. 2020**, *Remote Sensing*. 12, 193.

Want to contact me ? jonas.biren@cnrs-orleans.fr https://www.researchgate.net/profile/Jonas_Biren