



**HAL**  
open science

## Equivalent mechanical load model methodology to simulate lightning strike impact on protected and painted composite structure

A. Bigand, Christine Espinosa, J.M. Bauchire

### ► To cite this version:

A. Bigand, Christine Espinosa, J.M. Bauchire. Equivalent mechanical load model methodology to simulate lightning strike impact on protected and painted composite structure. *Composite Structures*, 2022, 280, pp.114886. 10.1016/j.compstruct.2021.114886 . hal-03550650

**HAL Id: hal-03550650**

**<https://hal.science/hal-03550650v1>**

Submitted on 5 Jan 2024

**HAL** is a multi-disciplinary open access archive for the deposit and dissemination of scientific research documents, whether they are published or not. The documents may come from teaching and research institutions in France or abroad, or from public or private research centers.

L'archive ouverte pluridisciplinaire **HAL**, est destinée au dépôt et à la diffusion de documents scientifiques de niveau recherche, publiés ou non, émanant des établissements d'enseignement et de recherche français ou étrangers, des laboratoires publics ou privés.



Distributed under a Creative Commons Attribution - NonCommercial 4.0 International License

1 Equivalent mechanical load model methodology to simulate lightning strike impact  
2 on protected and painted composite structure

---

3 A. Bigand<sup>abc\*</sup>, C. Espinosa<sup>a\*</sup>, J.M. Bauchire<sup>c</sup>

4 <sup>a</sup> Institut Clément Ader (ICA), Université de Toulouse, CNRS-INSA-ISAE-Mines Albi-UPS, 3 Rue  
5 Caroline Aigle, 31077 Toulouse Cedex 4, France – [christine.espinosa@isae-superaero.fr](mailto:christine.espinosa@isae-superaero.fr)

6 <sup>b</sup> Airbus Operations SAS, 316 route de Bayonne, 31060 Toulouse Cedex 09, France,

7 <sup>c</sup> GREMI, UMR 7344, CNRS-University of Orleans, 14 rue d'Issoudun, BP 6744, 45067 Orleans  
8 Cedex 2, [jean-marc.bauchire@univ-orleans.fr](mailto:jean-marc.bauchire@univ-orleans.fr)

9 \*corresponding author: [audrey.a.bigand@airbus.com](mailto:audrey.a.bigand@airbus.com) +33(0)5 67 19 56 87

10 **Keywords:** lightning; impact; carbon fibre reinforced plastics; numerical simulations; paint

11

12 **Abstract**

13 Lightning strike damage on aircraft composite structure is very difficult to predict. The main  
14 source of this damage is the mechanical constraint generated by the lightning in interaction  
15 with the structure made of composite, protected with a metallic mesh and painted. The  
16 purpose of this paper is to propose a numerical model able to reproduce the surface  
17 overpressure generated by the explosion of the lightning strike protection (LSP) and its  
18 confinement with the paint. Comparisons of numerical displacements with lightning  
19 experimental ones are presented in order to analyse the predictability of the model. This is a  
20 first step in order to assess the damage in the composite structure depending on the design  
21 configurations (CFRP, LSP and Paint) when combined with a damage model.

22

## 23 **1. Introduction and context**

24 In the last 40 years, the use of composites has significantly increased in the aircraft industry,  
25 as carbon fibre reinforced composites present a higher strength and stiffness to mass ratio  
26 compared to metallic structures. Despite their excellent mechanical properties, composites  
27 are poor conductors, making them more susceptible to serious damage due to a lightning  
28 strike such as severe delamination, burning and possibly puncture [1]. In order to protect the  
29 composite structures, a lightning strike protection layer, usually a metallic mesh, is applied  
30 on the external surface.

31 It is extremely difficult to predict the damage incurred by the composite structure since  
32 different types of damage occur: fibre tufting and resin decomposition on one hand, and  
33 delamination and matrix cracking on the other hand. This is indeed a highly dynamic and  
34 multi-physics phenomenon. There is no fully validated theory on all the physics phenomena  
35 involved by the arc and its interaction with the structure or the associated chronology. Still, a  
36 proposal of the different constraints involved has been developed [2] and illustrated in Figure  
37 1. On one side, there are thermal forces with the thermal flux at the arc root, the thermal  
38 radiation from the arc channel and the joule heating from the current flow. On the other  
39 side, there are mechanical forces with Laplace forces and shock wave from the arc  
40 generation.

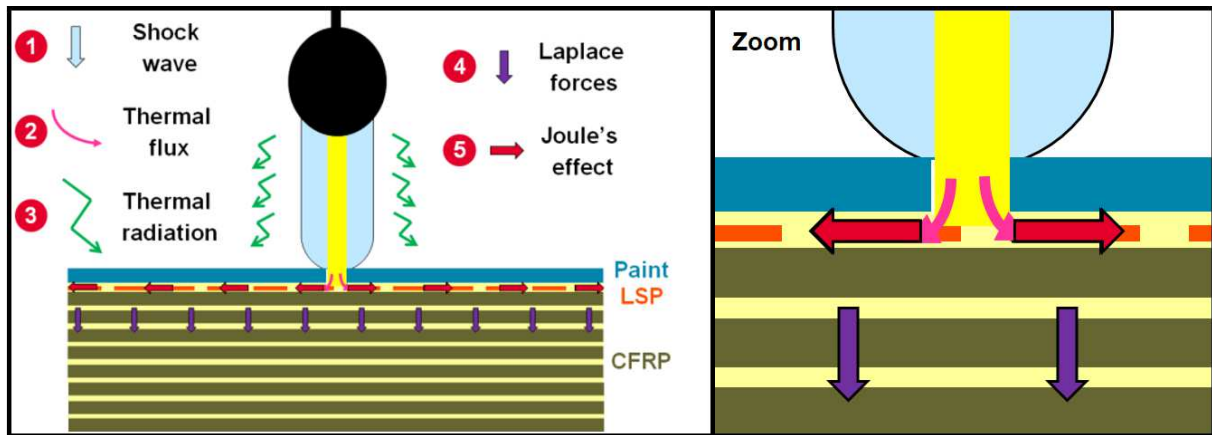
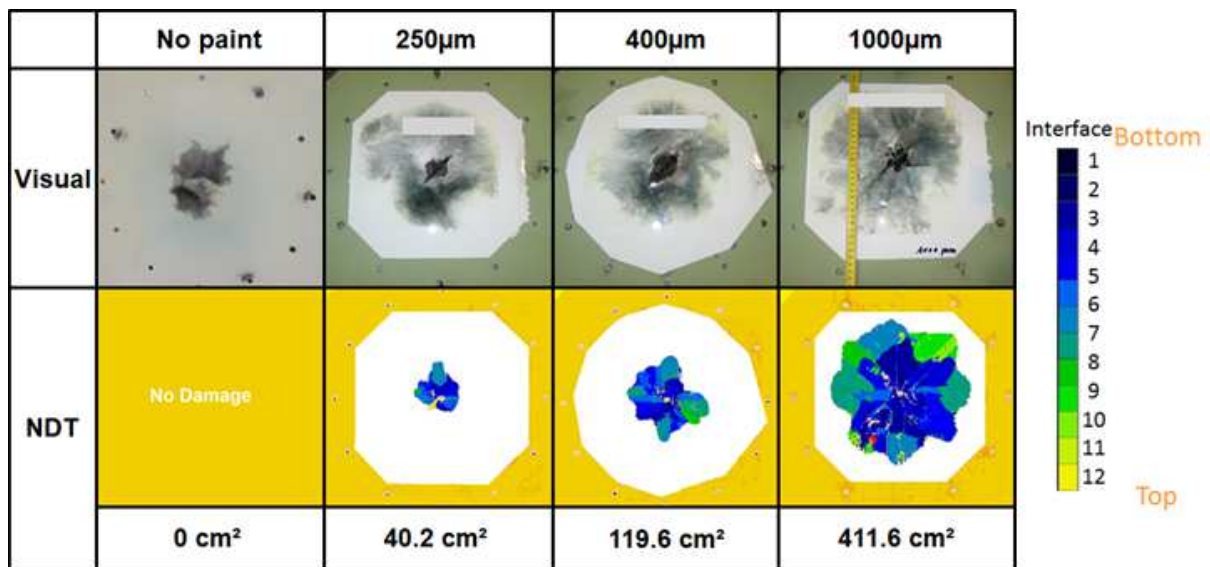

Figure 1 Lightning constraints generation in composite structures

41  
42  
43  
44  
45  
46  
47  
48  
49  
50  
51  
52  
53  
54  
55  
56  
57  
58

Work performed in the past to simulate damage induced by a lightning strike, which can be found in the literature, was first based on a simple electro-thermal approach in which the current flow in the composite generates heat that will create damage [3–7]. These models were subsequently refined by considering the degradation of the resin by pyrolysis [3,6–12]. In many cases, the arc was modelled as an equivalent current source with a fixed injection area. It has been demonstrated, however, that the arc root interacts with the structure and that its injection is variable in time and space [13–15]. Finally, this approach showed its limitations since it proved unable to predict the underlying delamination coming from a mechanical constraint. In order to assess delamination, which is the most detrimental effect for the sustainability of the structure, a model of the mechanical sources generated by the arc, i.e. the shock wave and the magnetic pressure, was introduced [16–23]. However, the theory is not fully validated yet and the magnitude and distribution of these forces are highly dependent on the arc root interaction. This sensitivity makes it very difficult to weight these two contributors correctly. Even if a more accurate model could be developed, this would not suffice to predict the damage as the values of these forces that were determined were not high enough to generate significant stress in the composite [21,23].

59 This led some researchers to investigate the explosion effect of the composite but also the  
 60 role of the metallic protection on the surface of the structure as the sudden and high  
 61 lightning current flowing in the conductor leads to a rapid increase in temperature up to an  
 62 explosion [16,24,25]. Finally, it is not enough to consider the different forces that can be  
 63 generated by a lightning strike; it is also necessary to take into account the total system that  
 64 will interact with these forces. Of course, the composite structure where damage prediction  
 65 is essential is part of it. But in addition, the lightning strike protection and the paint must be  
 66 introduced in the model [26]. Indeed, lightning tests on protected composite structure with  
 67 different paint thickness highlighted its significant influence on the damage generation in  
 68 composite structure. In Figure 2 below, the visual damage and the delamination, measured  
 69 by Non Destructive Test (NDT), are compared with this increasing parameter:



70  
 71 **Figure 2 Lightning damage evolution in CFRP panel (13 plies) protected with ECF195 with different paint thickness**  
 72 This influence is mainly due to the confinement effect of the lightning strike protection (LSP)  
 73 explosion by the paint that will enhance the overpressure.

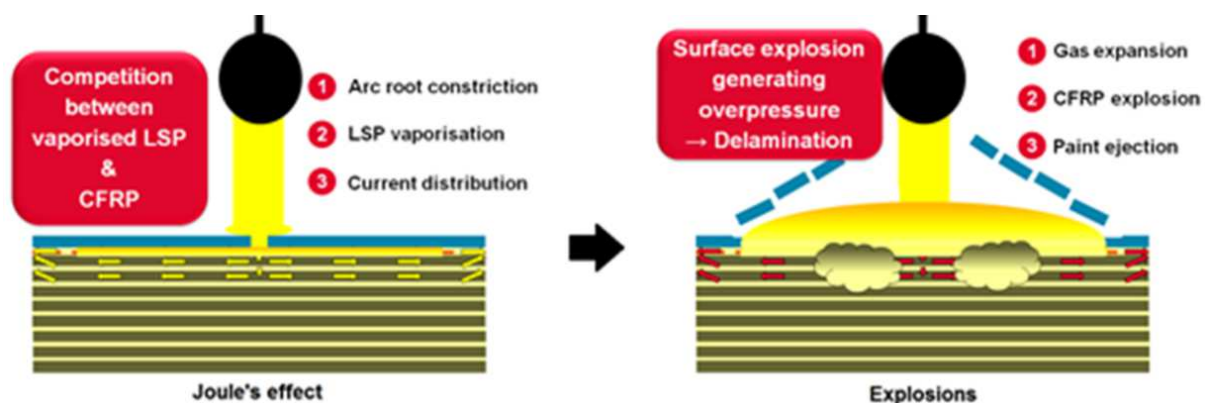

Figure 3 Lightning surface explosion

74

75

76 In this paper, we will present a methodology for the construction of the equivalent  
 77 mechanical load due to lightning strike on a complete structure, considering the CFRP, the  
 78 LSP and the paint.

## 79 2. Basis of the work

### 80 2.1. Lightning experimental results

81 In order to study the different parameters that play a role in the generation of lightning  
 82 damage, specific lightning tests were performed during the EDIFISS project. All the samples  
 83 were flat square panels of 450mm lateral dimension, mechanically and electrically perfectly  
 84 bonded to a circular metallic frame through 12 fasteners distributed along its 370mm  
 85 diameter. A lightning strike of 100kA following waveform D [27] is performed in the centre  
 86 of the panel on the front face (side where the LSP is applied). The rear face displacement is  
 87 measured thanks to the image correlation technique used by DGA-TA [28]. Two high speed  
 88 cameras Photron SA5 are installed at specific angles behind the panel which has been  
 89 painted with a black and white pattern calibrated through a focus frame. Pictures are taken  
 90 at a rate of 262,500 frames per second (fps) with a resolution of 128x128 pixels, covering a  
 91 central area of the sample of 80x80 mm<sup>2</sup>. Figure 4 illustrates the test setup:

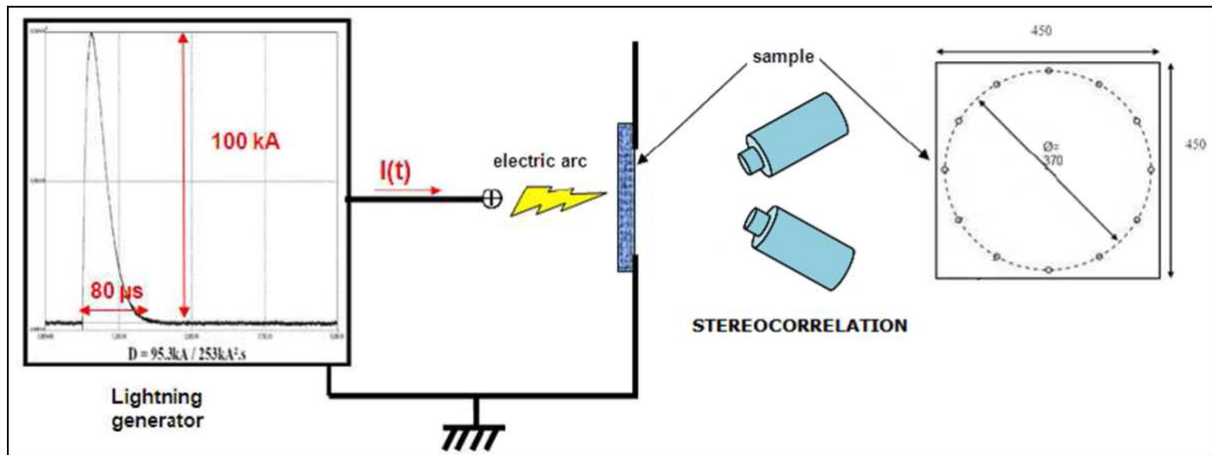

92

93 **Figure 4 Lightning test setup**

94 In a first step, the surface explosion due to Joule heating in LSP layer was studied  
 95 independently from the CFRP internal damage thanks to specific tests based on the GFRP  
 96 substrate. Indeed, due to its high resistivity, the lightning current will not be diverted into  
 97 the glass fibre composite panel and will only flow in the metallic LSP. Therefore, the  
 98 displacement of the panel is due only to the explosion occurring at the surface. Another  
 99 interest of this configuration is that no damage is created in the laminate, therefore an  
 100 elastic model of the panel without a damage law is sufficient to simulate its mechanical  
 101 behaviour.

102 In a second step, CFRP substrates were tested. At the surface, the confinement effect was  
 103 studied through the influence of paint thickness on the damage severity. The paint  
 104 thicknesses considered were 50μm, 250μm, 400μm, and 1000μm). In the core, the influence  
 105 of the global panel stiffness on the final extent of damage was studied thanks to a thicker  
 106 panel. The LSP was in all cases ECF195 from Dexmet®.

107 A summary of the user cases is listed in Table 1 below:

Rationale	Substrate	Paint thickness (μm)
Confined surface explosion baseline	GFRP 2,75mm / 11 plies	400
Free surface explosion baseline	GFRP 2,75mm / 11 plies	0
<b>Baseline CFRP structure</b>	<b>CFRP 1,651mm / 13 plies</b>	<b>400</b>
Extreme surface confinement	CFRP 1,651mm / 13 plies	1000
Light surface confinement	CFRP 1,651mm / 13 plies	250

Stiffness influence	CFRP <b>3,302mm</b> / 26 plies	400
Stacking and CFRP grade influence	CFRP 1,651mm / <b>9 plies</b>	400

108 **Table 1 Summary of user cases**

109 The profile of the out-of-plane displacement along an 80 mm long line along the ( $x=0^\circ$ )  
110 direction centred on the rear face central point is reported as a function of time. From the  
111 curves, several types of information can be extracted such as the maximum displacement  
112 and its rate at the centre versus time, or the slope and base of displacement along ( $x=0^\circ$ )  
113 versus time. The maximum of displacement is mainly reached before  $100\mu s$ . The comparison  
114 between the model and the test will be performed up to this moment. The principle is  
115 illustrated in Figure 5 :

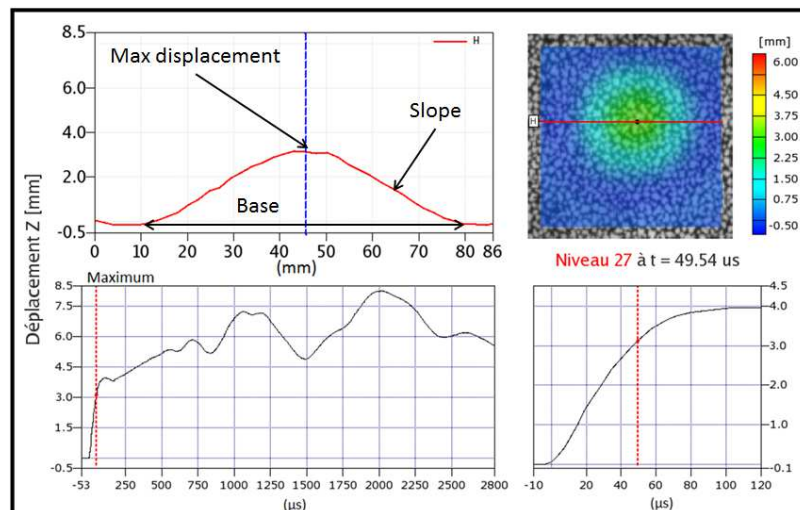

116  
117 **Figure 5 Rear face out of plane displacement measurement from image correlation**

118  
119 **2.2. The surface mechanical load hypothesis**

120 The model proposed here considers only the contributions on the surface of the composite.  
121 These contributors are the explosion of the lightning strike protection, the confinement from  
122 the paint and possibly the lightning arc shock wave. The main hypothesis taken here is that  
123 the thermal damage in the composite structure due to the lightning current flow in the  
124 fibres is negligible. This thermal source could have two different influences: the contribution



125 of the explosion of the composite ply in the global overpressure [29] and the modification of  
 126 the composite panel mechanical properties.

### 127 2.2.1. The composite explosion

128 Since we cannot measure the pressure generated by a lightning strike, we measured the  
 129 displacement of the back of 11 GFRP ply (2.75mm) panels protected with LSP, with or  
 130 without a CFRP ply (127 $\mu$ m) in between, thanks to the DIC method, and painted with 400 $\mu$ m  
 131 of typical aeronautic white paint. The added contribution of the explosion of the underlying  
 132 composite ply to the total overpressure generated by the explosion of the metallic  
 133 protection was limited: Rear face deflections measured without and with the underlying  
 134 CFRP ply on top of the GFRP substrate were very similar. First, for the SCF configuration, the  
 135 amplitudes and shapes of the measured displacement profile around the rear face centre at  
 136 different instants after the test strike were quasi-identical with or without the CFRP ply. In  
 137 this configuration, there was no current flowing into the LSP in opposition to ECF, therefore  
 138 the overpressure was due only to explosion of the LSP. The presence of dry fibre is visible  
 139 with ECF but not with SCF with 400 $\mu$ m of paint as illustrated in Figure 6.

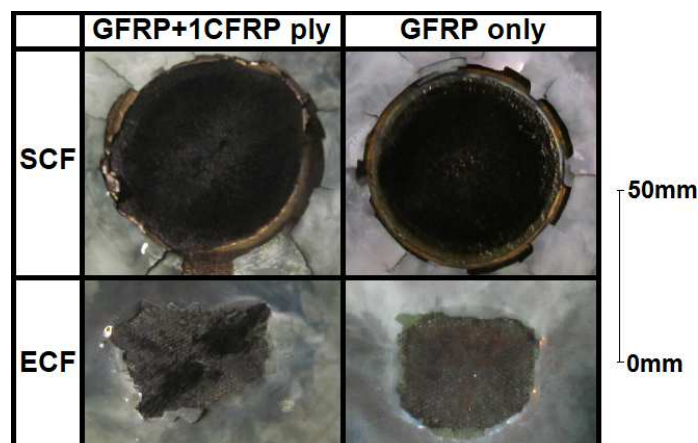

140  
 141 **Figure 6 Visual damage observation between ECF and SCF with or without underlying CFRP ply**

142 The deflection is not changed by the presence of the CFRP ply. Indeed, the equivalent  
 143 bending modulus from the laminate theory [30] of the GFRP panel with an additional CFRP

144 ply at 45° is very similar to the reference GFRP panel. If we consider, in a simple approach,  
 145 an equivalent shell, we can define an equivalent elastic bending modulus  $E_{fx}$  in x direction for  
 146 the composite laminate:

$$E_{fx} = \frac{12}{h^3} \times \bar{E}I_{11} \quad 1$$

147

148 With  $h$  the laminate thickness and  $\bar{E}I_{11}$  the laminate equivalent elastic stiffness. From the  
 149 laminate theory explicated by Gay [30], this elastic stiffness of a balanced laminate can be  
 150 calculated from the bending stiffness factors  $C_{ij}$ :

$$\left\{ \begin{array}{l} \bar{E}I_{11} = C_{11} - \frac{C_{12}^2}{C_{22}} \\ C_{ij} = \sum_{k=1^{st}ply}^{n^{th}ply} \bar{E}_{ij}^k \frac{(z_k^3 - z_{k-1}^3)}{3} \end{array} \right. \quad 2$$

151

152 The factor  $C_{ij}$  is dependent on the laminate distribution, ply orientation and property  $\bar{E}_{ij}$  of  
 153 each ply. The location of the ply  $k$  in the laminate depth is identified by  $z_k$  and  $z_{k-1}$ ,  
 154 respectively the top and bottom height positions of the ply in the laminate with the origin  
 155 located in the medium plane. This stiffness coefficient  $\bar{E}_{ij}$  ( $i,j=1..3$ ) is a projected value of the  
 156 ply coordinate system  $(l,t)$  in the global coordinate system  $(x,y)$  of the ply elastic modulus as  
 157 presented in Figure 7 below:

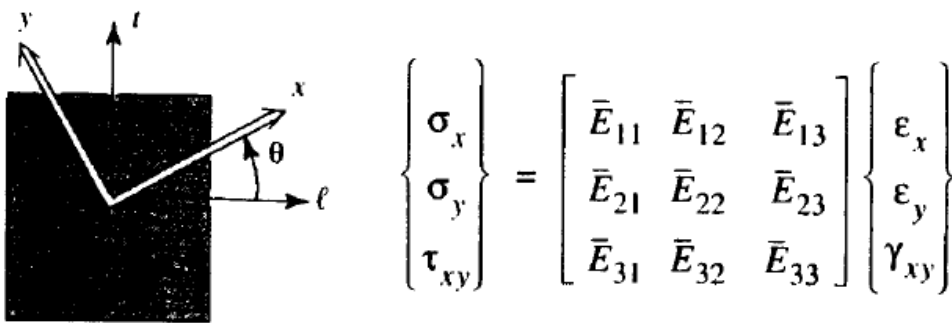

158

159 Figure 7 Elastic relationship projection in the global coordinate system [30]

160 For the assessment of the equivalent elastic bending modulus  $E_{fx}$ , we need to compute the  
 161 factors  $(\bar{E}_{11}, \bar{E}_{22}, \bar{E}_{12})$  for each ply orientation  $\theta$  :

$$\begin{cases} \bar{E}_{11} = c^4 \bar{E}_l + s^4 \bar{E}_t + 2c^2 s^2 (v_{tl} \bar{E}_l + 2G_{lt}) \\ \bar{E}_{22} = s^4 \bar{E}_l + c^4 \bar{E}_t + 2c^2 s^2 (v_{tl} \bar{E}_l + 2G_{lt}) \\ \bar{E}_{12} = c^2 s^2 (\bar{E}_l + \bar{E}_t - 4G_{lt}) + (c^4 + s^4) v_{tl} \bar{E}_l \end{cases} \quad 3$$

162

163 with  $\bar{E}_l = E_l / (1 - v_{tl} v_{lt})$ ,  $\bar{E}_t = E_t / (1 - v_{tl} v_{lt})$  and  $c = \cos \theta$ ,  $s = \sin \theta$ .

164 If we neglect that the laminate is not fully balanced with the addition of the CFRP ply on the  
 165 GFRP substrate, we can calculate the bending modulus with the same approach. The GFRP  
 166 plate presented a bending modulus of 24GPa and the addition of the CFRP ply change the  
 167 modulus to 27GPa which is only 12% higher. The assessment of the laminate behaviour  
 168 based on the flexion is limited but it provides a first framework of comparison to study the  
 169 influence of such a configuration. A similar approach was used by Soulas [18] considering an  
 170 equivalent bending stiffness factor, as the mean value of  $C_{11}$  and  $C_{22}$ , in order to compute an  
 171 equivalent impulse.

172 For the ECF configuration, the influence of the presence of a CFRP layer changes the  
 173 maximum amplitude of deflection slightly but also the span. The maximum deflection is  
 174 lower, possibly because part of the current has been diverted to the CFRP which decreases  
 175 the explosion pressure of the LSP in this area. This is illustrated in Figure 8 below on the right  
 176 hand side.

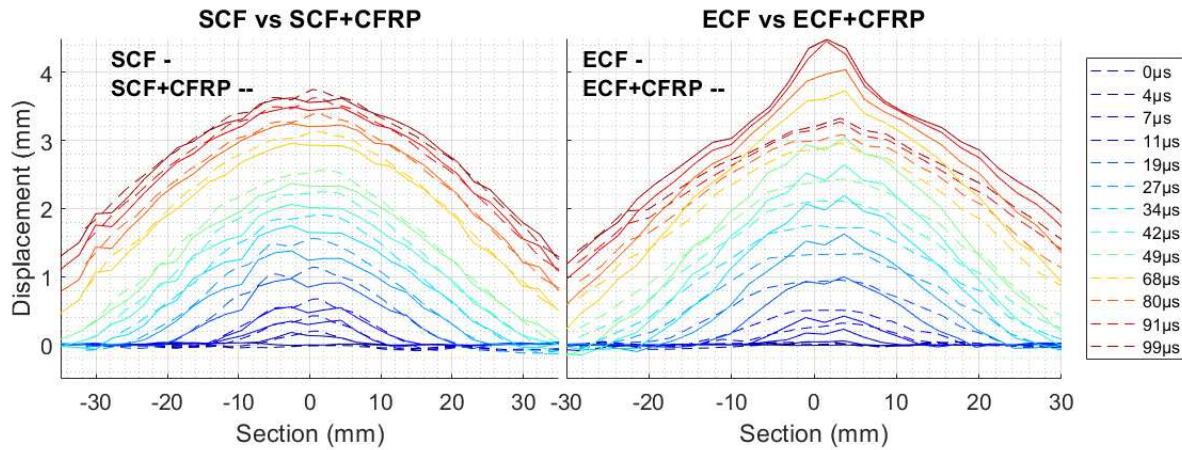

177

178 **Figure 8 CFRP explosion influence on total deflection (Bump due to digital image correlation defect during test)**

179 With these test results, we can generally, in a first stage, neglect the contribution of the  
 180 CFRP explosion in the overpressure generation that will contribute to the mechanical  
 181 damage. In addition, we neglect the internal damage of the CFRP due to Joule heating.

182 **2.2.2. The thermal damage**

183 The current flow in the composite generates Joule heating which can break the composite  
 184 fibres and deteriorate the resin. This damage occurs at the same time as the mechanical load  
 185 and could impinge the mechanical resistance of the panel to the impact. A thick paint  
 186 applied on a composite structure constrains the arc expansion, forcing the lightning current  
 187 to flow deeper in the composite than with a thinner coating. In Figure 9 below, the plies  
 188 damaged by the current flow are visible thanks to a microcut done in the centre. The first ply  
 189 in this section is destroyed and the second ply is highly damaged. Even with this very severe  
 190 configuration where the arc root is highly constrained, the deepest ply burned is the fourth  
 191 one among the thirteen plies of the panel with a total thickness of 1.65 mm.



192

193 **Figure 9 Internal damage study for severe configuration: CFRP (13plies) + ECF195 + 1000 $\mu$ m of paint**

194 This configuration is considered severe since 1000 $\mu$ m of paint is not expected on an aircraft,  
 195 where the usual thickness is between 250 $\mu$ m and 400 $\mu$ m. For this nominal configuration,  
 196 only the first ply is burned. Due to the high electrical resistance of the composite, the  
 197 current penetrates locally in the depth of the laminate but soon after flows back to the  
 198 surface metallic protection. The thermal damage is therefore highly localised even for a  
 199 severe configuration. Then, the thermal expansion is also supposed to be limited to these  
 200 affected plies which are already damaged by Joule heating and its extension to the  
 201 surrounding plies will be limited due to the slow process of heat transfer. It is therefore not  
 202 expected to significantly change the mechanical behaviour of the plate.

203

### 204 **2.3. The mechanical model**

205 Due to the circular clamping mechanical boundary condition, only the disk in this area will be  
 206 modelled and its boundary will be “encastre” in the Abaqus® input file  
 207 ( $U1=U2=U3=UR1=UR2=UR3=0$ ). In Abaqus/Explicit®, a single layer of shell finite elements (S3  
 208 and S4R) with elastic material properties, as defined in Table 6 5, and a user defined load  
 209 (VDLOAD) on the top surface were implemented. The model proposed here considers only  
 210 the contributions on the surface of the composite. These contributors are the explosion of

211 the lightning strike protection, the confinement from the paint and possibly the lightning arc  
 212 shock wave.

	Density	E <sub>11</sub>	E <sub>22</sub>	G <sub>12</sub>	G <sub>13</sub>	G <sub>23</sub>	V <sub>12</sub>	Ply thickness	Ply number	Stacking
<b>GFRP</b>	1.88	24	24	4.8	4.8	4.5	0.28	0.25	11	0° for all plies
<b>CFRP</b>	1.58	165	8.5	4.2	4.2	3.36	0.35	0.127	13	45/-45/90/45/-45/0/90/0/-45/45/90/-45/45
<b>Unit</b>	g/cm <sup>3</sup>	GPa	GPa	GPa	GPa	GPa	N/A	mm	N/A	N/A

213 **Table 2 GFRP material properties**

214 A composite layup is defined in the shell property to simulate all the plies in the unique shell  
 215 layer. Due to the quick spatio-temporal expansion of the pressure applied with the VDLOAD,  
 216 the mesh is refined to 0.5mm and ordered in a square of 150mm on the centre of the disk.

217 The mesh details are given below:

No. of elements	Element type	No. of nodes	DOF
64,090	S4R	155,026	930,156
181,468	S3		

218 **Table 3 GFRP shell mesh details**

### 219 **3. Lightning equivalent load methodology**

220 Lightning strike on a composite structure generates high overpressure due to the explosion  
 221 of the lightning strike protection on its surface, enhanced by the confinement due to the  
 222 presence of paint. The profile of this overpressure is not constant in time and space but  
 223 variable and dependant on the lightning protection and the paint. This paragraph presents  
 224 the methodology to build the surface overpressure profile equivalent to a lightning strike.  
 225 Because the pressure load on the top face of the composite surface is not constant in time  
 226 and space, we need to use a user subroutine that will allow us to define the magnitude of  
 227 the load in Abaqus/Explicit® with a space-time function. As explained earlier, one of the  
 228 main contributors is the overpressure generated by the rapid vaporization of the metallic  
 229 lightning strike protection that covers the composite aircraft surface and aims at diverting  
 230 lightning current. Our focus is on ECF195 which is mainly used for lightning protection. Based

231 on the development detailed in [13], the lightning strike protection is approximated in this  
 232 part by a web of wires of  $\varnothing 125\mu\text{m}$  for this configuration. Each wire is considered as a source  
 233 of overpressure dependent on current density, which will generate Joule heating, which is  
 234 assessed as follows:

$$J_n = I_n / S \quad 4$$

235  
 236 with  $I_n$ , the total injected current (100kA for waveform D) divided by the number of wires in  
 237 intersection with the vaporization profile and  $S$ , the section of the wire. The vaporisation  
 238 profile was obtained thanks to high speed camera measurements through transparent GFRP  
 239 panels [13]. The boundary of this profile is recorded every micro second and is  
 240 superimposed on the ECF pattern in order to count the number of intersections as shown in  
 241 Figure 10 below:

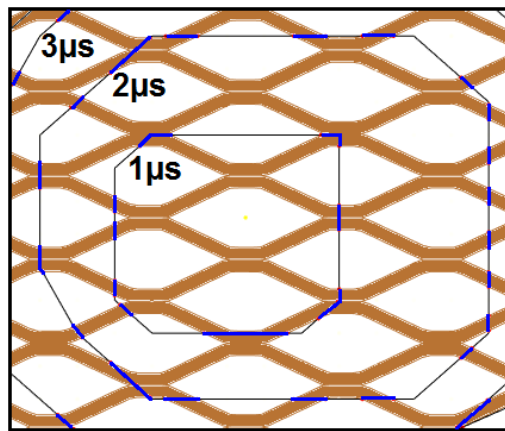

242  
 243 **Figure 10 Vaporisation profile intersection with ECF**

244 Since the measurement of the vaporisation profile is noisy due to the filter dependency on  
 245 light intensity which varies during the test, a smooth profile was developed thanks to Matlab  
 246 fit function in order to determine the parameter  $\alpha$  of equation 5. For this purpose, the  
 247 vaporisation profile was converted into the polar coordinate system and a radius function was  
 248 defined per angle degree as follows:

$$R(\theta, t) = R_{max}(\theta)(1 - e^{-\alpha(\theta) \times t}) \quad 5$$

249

250 with  $\theta$  the angle, from 1 to 360°,  $t$  the time of the vaporisation profile expansion,  $R_{\max}$  the  
251 maximum radius reached at  $\theta$  angle direction and  $\alpha$  a fitting parameter dependent on the  
252 angle. The function, illustrated in Figure 11, is therefore continuous with time and starts at

253 zero:

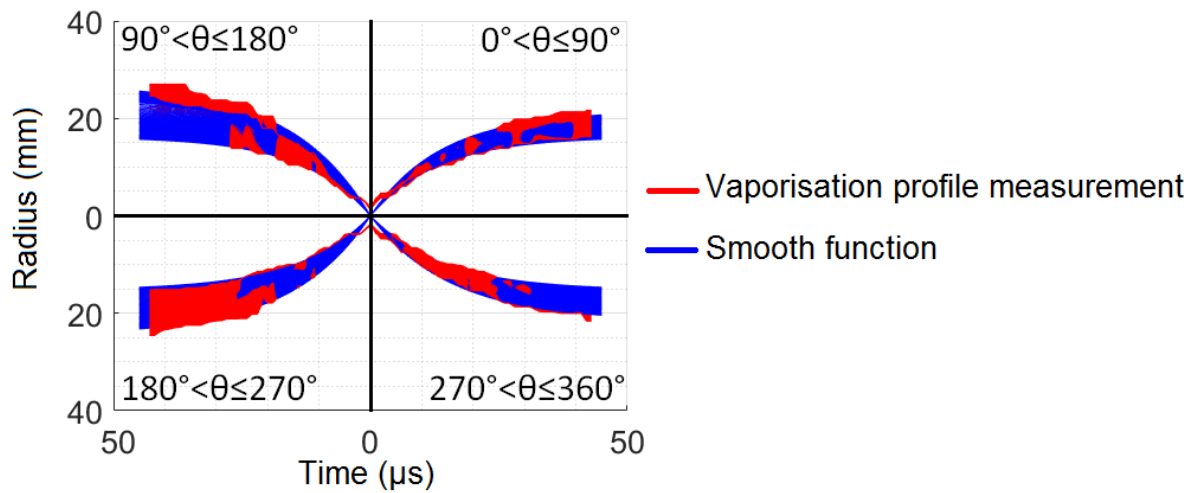

254

255 **Figure 11 Radius fitting function - Angle view**

256 The main advantage of such a definition is that it is independent from the picture sampling  
257 per  $\mu\text{s}$  and that it removes the variability due to measurement error, giving an increasing  
258 profile with time. This linearization of the spatial distribution of the vaporisation profile is  
259 illustrated in Figure 12 where the profile is projected on the time axis:



260

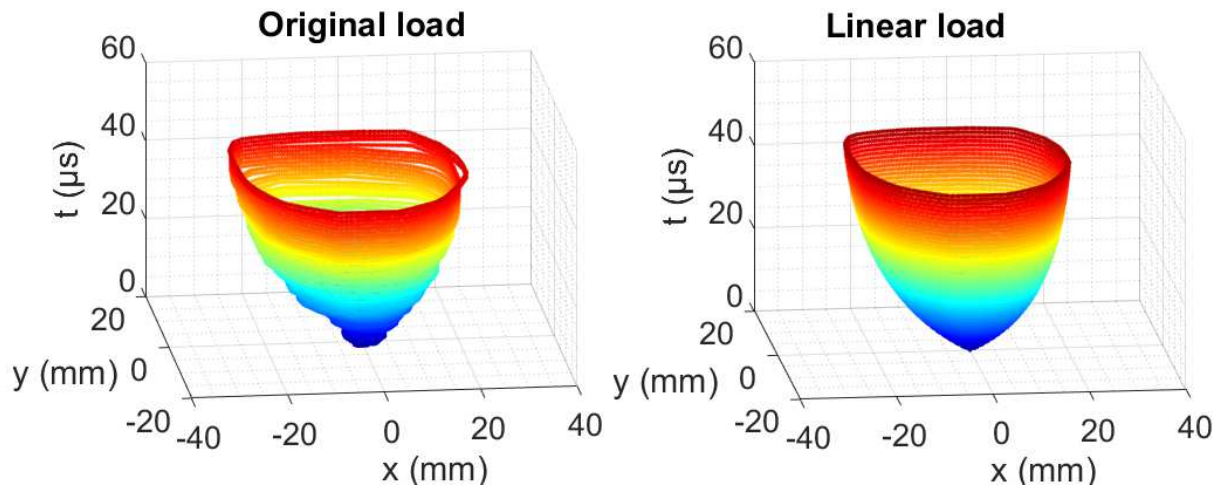

261

262 **Figure 12 Vaporisation profile linearization**

263 Based on this linearization of the spatial vaporisation, we can now assess the number of  
 264 intersections per wire of ECF at each time step, as illustrated in **Figure 13** With this number, a  
 265 current amplitude per wire can be defined by considering a homogenous distribution of the  
 266 current along the vaporisation boundary in each wire in intersection at a given time.

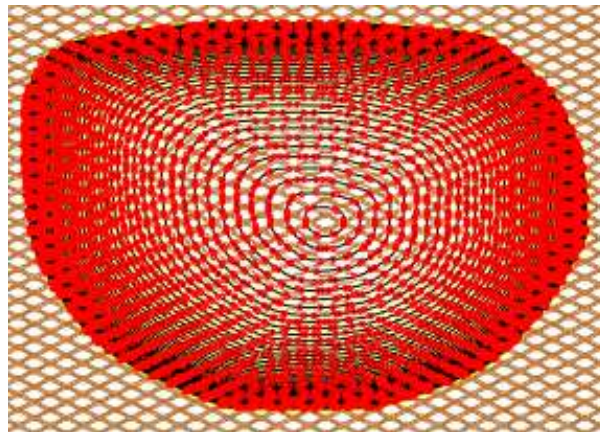

267

268 **Figure 13 Intersection detection with linear vaporisation profile (ECF195+400μm of paint)**

269 We can relate the pressure peak amplitude  $\Delta P^+$  of the wire explosion to the current amplitude  
 270  $I_{max}$  flowing in it based on experimental tests **[13]**:

$$P_{exp}(I_{max}) = a_1 I_{max}^{a_2} + a_3 \tag{6}$$

271

272 In this configuration,  $a_1=80.3$  (MPa.A<sup>-b</sup>),  $a_2=0.64$  and  $a_3=-62.88$ MPa. Those parameters were  
 273 determined with a function fit. Then, based on the vaporisation profile defined in the section,

274 we have a relationship between the explosion time and the current amplitude in the wire  $I_n$ .  
 275 Therefore, we can relate the pressure peak directly to the explosion time along the  
 276 vaporisation profile in order to simplify the VDLOAD as presented in **Figure 14**.

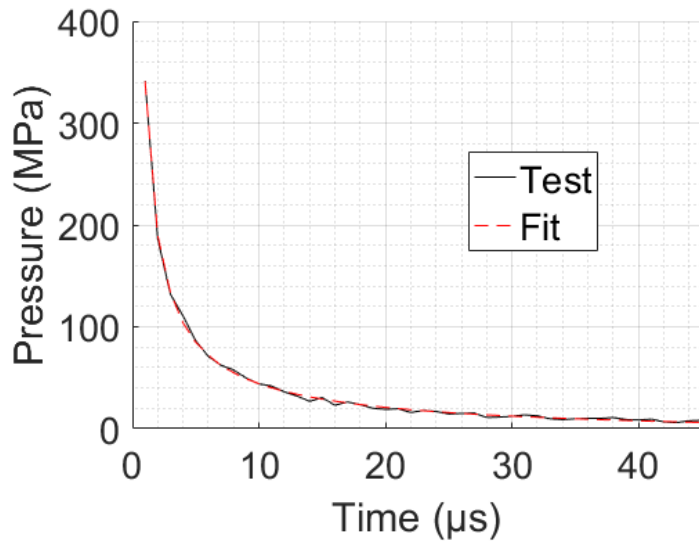

277  
 278 **Figure 14 Shock wave peak pressure dependency on the explosion time**

279 Knowing the vaporisation profile spatial distribution at each time step, we can associate the  
 280 peak pressure amplitude with a polynomial function dependent on the explosion time thanks  
 281 to Matlab fit function:

$$P_{exp}(t_{exp}) = p_1 t_{exp}^{p_2} + p_3 \quad 7$$

282  
 283 with  $t_{exp}$  the explosion time of the wire along the vaporisation profile in  $\mu s$ ,  $P_{exp}$  the associated  
 284 peak pressure in MPa.  $p_1=350.64812$  ( $MPa \cdot \mu s^{-1}$ ),  $p_2=-0.81381945$  and  $p_3=-9.6754547$  (MPa)  
 285 for this configuration of the ECF195 vaporisation profile confined by  $400\mu m$  of paint. This  
 286 process will be performed for each configuration of LSP and paint thickness since it will change  
 287 the vaporisation profile, the explosion time and the peak pressure amplitude with the current  
 288 density.

289 This function 7 will be useful for the VDLOAD, to prescribe the pressure load in each finite  
 290 element at each instant. Note that, nevertheless, it uses the initial position of the grid to

291 determine the maximum pressure. Consequently, to apply the corresponding pressure, it is  
292 necessary to locate the initial position of the application point.

293 Indeed, in reality, during the load application, a deflection of the sample will occur, thus in the  
294 numerical model the finite element mesh cells are expected to move as well from their original  
295 position. Therefore, the comparison of the element location with the vaporisation profile  
296 distribution will lead to “jumps” in the load condition and an unexpected variation of the  
297 pressure with time. Unfortunately, in the source file of an Abaqus® VDLOAD subroutine, it is  
298 not possible to identify each mesh element number individually which could have been an  
299 easy way to locate its initial position and assign a pressure history. In order to solve the issue,  
300 the VDLOAD was not applied on a single top surface but on several surface elements. To  
301 achieve this, the mesh coordinates of the composite front surface defined in the Abaqus®  
302 ‘.inp’ file were reviewed and superimposed with the space-time vaporisation profile. Each  
303 square mesh face of 0.5mmx0.5mm, that is included in the total load profile, was clearly  
304 identified and an explosion time was associated. In this case, 4429 elementary surfaces were  
305 defined. The ‘.inp’ file was modified to include the elementary surfaces, called “Surf\_XXXX”  
306 with XXXX the element number defined, and its associated load called “Load\_ XXXX”. Apart  
307 from the ‘.inp’ modification, a text file was created in which an explosion time is associated to  
308 the load n°XXXX. During the computation, the VDLOAD applies the load XXX on the associated  
309 surface XXX with an amplitude dependent on its associated explosion time as defined in **Figure**  
310 **15:**

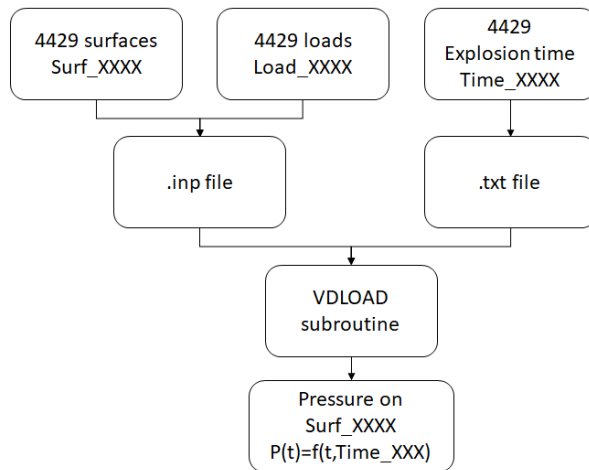

311

312

Figure 15 VDLOAD inputs

313

314 The VDLOAD subroutine calls the text file and identifies the explosion time. Therefore, each  
 315 load cell is identified and its maximum pressure can be defined thanks to the equation 69  
 316 established above based on its explosion time.

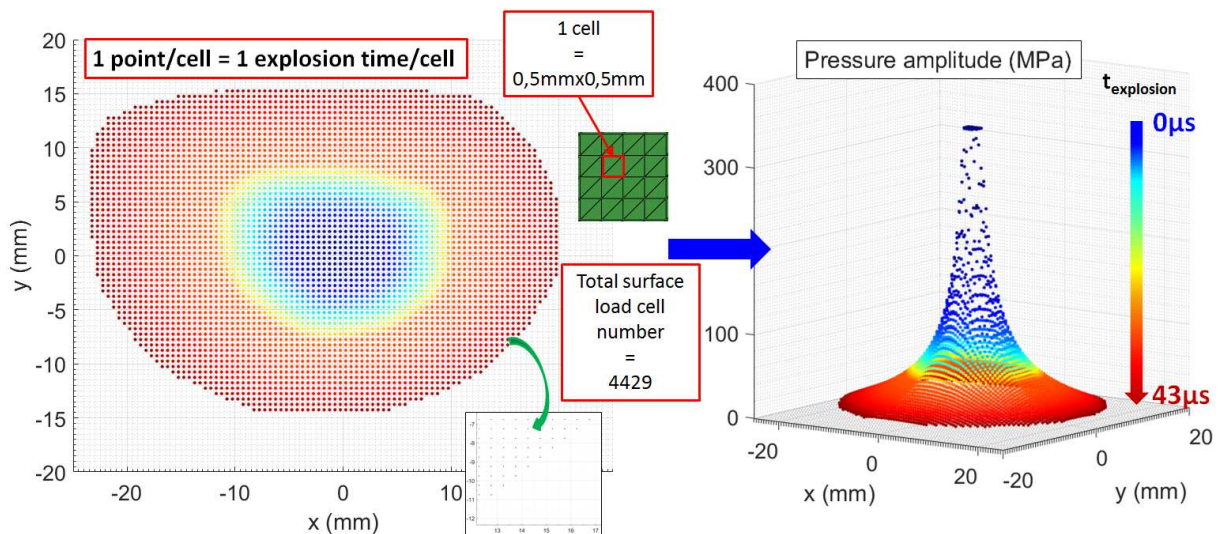

317

318 Figure 16 Vaporisation profile projection on mesh grid

319 As shown in Figure 16, the vaporisation profile defined as a function of time  $t$  and space  $(x,y)$   
 320 was projected and the explosion time is identified at the centre of each cell. One cell is one  
 321 square of the mesh on the top face of the composite panel modelled. In our case, the first  
 322 composite ply orientation is oriented at  $45^\circ$ , therefore one cell is made of 2 prismatic finite  
 323 elements' top faces.

324 The pressure profile per cell will be defined as shown in Figure 17. Before the explosion time  
 325 associated to the cell, no pressure is applied. Then, the pressure linearly increases up to its  
 326 maximum as defined by equation 8 in  $\Delta t_{\text{peak}}=0.1\mu\text{s}$ . In theory, the time to peak for a shock  
 327 wave is considered null but a small  $\Delta t$  is introduced to limit numerical discontinuities. After  
 328 reaching its maximum, the pressure decreases. The decrease shape and duration ( $\Delta t_{\text{decay}}$ )  
 329 should depend on the confinement. For a free explosion of the LSP, i.e. an unpainted panel,  
 330 the pressure shape is considered similar to the shock wave law based on the Friedlander  
 331 equation:

$$P(t) = P_{\text{exp}} e^{-\frac{(t-t_{\text{explosion}})}{\Delta t_{\text{decay\_free}}}} \times \left( 1 - \frac{(t-t_{\text{explosion}})}{\Delta t_{\text{decay\_free}}} \right) \quad 8$$

332  
 333 The decay time  $\Delta t_{\text{decay\_free}}$  is considered dependent on the amplitude of the explosion where  
 334 the decay is longer with the pressure amplitude decrease. For a confined configuration where  
 335 a paint layer is present above the LSP and confines the gas of the explosion, this quick decay  
 336 of the pressure cannot be considered anymore. Several shapes of pressure decay dependent  
 337 on decay duration were tested and will be presented in the next section. The decay duration  
 338 is defined dependent on the pressure ratio between the maximum pressure  $P_{\text{max}}$  that will be  
 339 applied on the panel, corresponding to the most central area where the current density is the  
 340 highest, and the cell pressure of explosion  $P_{\text{exp}}$ . Indeed, our hypothesis is that a high pressure  
 341 amplitude will quickly eject the paint above and release the pressure. In the meantime, the  
 342 pressure is almost fully maintained. When the pressure produced by the explosion decreases  
 343 as the Joule heating in the LSP is lowered, it will delay the ejection of the paint and the  
 344 pressure will be applied during a longer period.

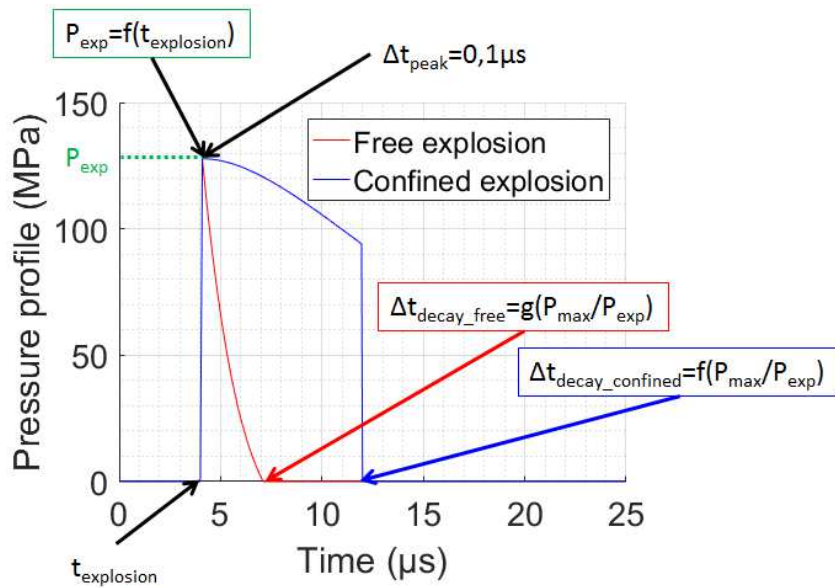

345

346 **Figure 17 Pressure profile for VDLOAD**

347

#### 348 **4. Results and analysis**

##### 349 **4.1. Surface explosion validation**

350 In order to validate the contribution from the surface explosion only, a simulation for GFRP  
 351 panels was performed. As already mentioned, specific lightning tests have been performed  
 352 in laboratories where different LSP have been applied on a GFRP substrate which has the  
 353 main advantage of being highly resistive. Therefore, all the lightning current will flow in the  
 354 metallic protection, leading to its explosion. With this configuration, no delamination or  
 355 Joule heating occur in the laminate, thus the substrate can be simulated with a simple elastic  
 356 behaviour. The VDLOAD subroutine is used to apply a pressure profile dependent on time  
 357 and space as described earlier. The only unknown is the decrease in the pressure when the  
 358 metallic explosion is confined by paint or free. We have thus simulated several load  
 359 configurations in order to assess the influence of the decay on the panel deflection.

360 **4.1.1. Free surface explosion**

361 In a first step, we considered the free explosion of the LSP with different decay times  $\Delta t_{\text{decay}}$ .  
362 It was not possible to use the method defined in [13] to derive a space-time vaporisation  
363 profile, since the light coming from the arc column was not filtered in the absence of paint  
364 and disturbed the light capture. Therefore, we used the vaporisation profile simulated with  
365 COMSOL® [31] since it presented good correlation with the experimental melting profile.  
366 The pressure decay follows this Friedlander law defined above.  
367 The displacement due to a free explosion of ECF195 is very limited. For the GFRP  
368 configuration, the maximum displacement after 100 $\mu\text{s}$  is only around 1mm compared to  
369 almost 4mm for a confined explosion with 400 $\mu\text{m}$  of paint as shown in Figure 18 below:

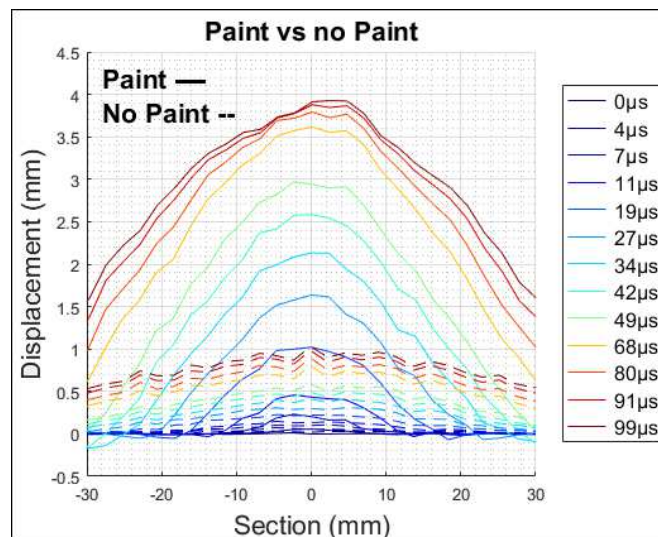

370  
371 **Figure 18 Displacement profile comparison: Paint vs no Paint**

372 Considering a uniform decay time over the loaded faces no matter what the explosion  
373 pressure amplitude, or considering a decay time inversely proportional to the peak pressure  
374 resulted in displacement profiles that were never really comparable to the test result: the  
375 displacement profile was too sharp at the start of the deflection, then too slow and the  
376 displacement away from the vaporisation profile area was not negligible compared to the  
377 central area. This led us to the conclusion that a contributor was missing. Since no current



378 can flow in GFRP panel protected with ECF195, there is no thermal stress due to Joule  
 379 heating in the panel and any thermal deformation due to heat transfer will occur on a later  
 380 stage [32] as it is a slow process compared to surface explosion. This is not supposed to be  
 381 the missing contributor and we surmised that it could be the acoustic shock wave from the  
 382 arc column. We therefore added this pressure to the LSP explosion pressure taking into  
 383 account the definition proposed by Karch [33]. This is an easy-to-use and very pragmatic  
 384 approach which does not consider any Magneto-Hydro-Dynamic (MHD) effect but provides  
 385 and gives the correct order of magnitude and can be implemented easily in a VDLOAD. The  
 386 spatial distribution is a growing disk of a radius R depending on time:

$$R(t) = 1.004 \times \left(\frac{E_0}{\rho_0}\right)^{0.25} \sqrt{t} \quad 9$$

387  
 388 with  $\rho_0$  the initial air density ( $\text{kg/m}^3$ ) and  $E_0$ , the initial arc energy density (J/m). The latter  
 389 parameter is a function of the maximum amplitude of the lightning current  $I_{\text{max}}$ :

$$E_0 = 0.45 \times 10^{-2} (I_{\text{max}})^{1.25} \quad 10$$

390  
 391 Then, the amplitude of the shock wave can be defined as follows:

$$P(\eta, t) = 0.18 \times (\rho_0 E_0)^{0.25} \times \frac{f(\eta)}{t} \quad 11$$

392  
 393 with  $f(\eta)$ , defined in [33], a dimensionless shape function dependent on the ratio of the  
 394 radius within the pressure disk and the shock front radius:  $\eta=r/R(t)$ . The shockwave pressure  
 395 is shown in Figure 19, from  $1\mu\text{s}$  to  $100\mu\text{s}$ , illustrating that a pressure is maintained after the  
 396 shock front passage and slowly decreases:



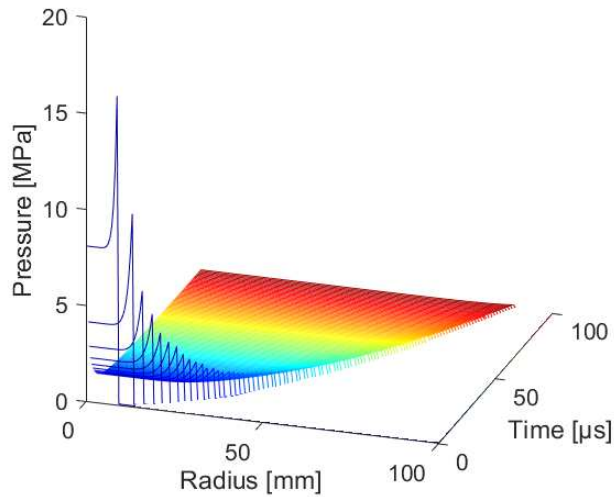

397

398 **Figure 19 Shock wave pressure distribution**

399 Looking at the contribution of the shock wave only on the panel deflection, we can conclude  
 400 that its contribution is about half the maximum displacement, and so is not negligible  
 401 compared to a free surface explosion, as illustrated on Figure 20:

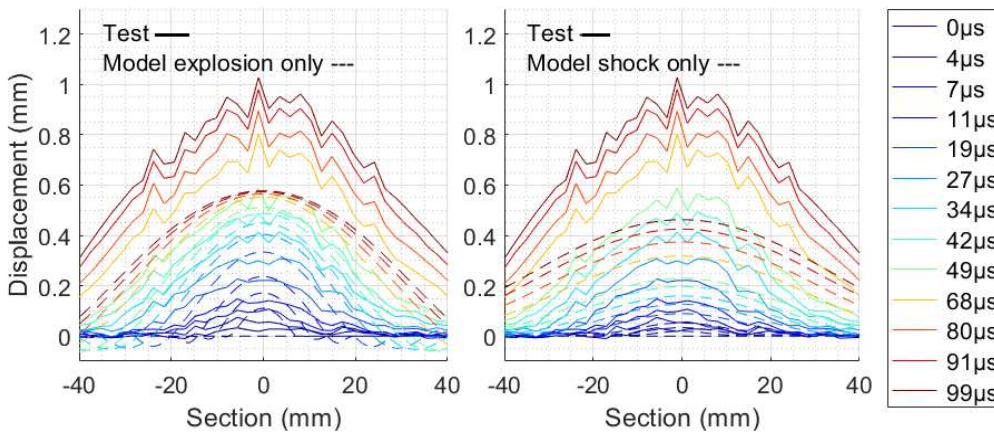

402

403 **Figure 20 GFRP displacement comparison between free explosion lightning test and simulated contribution of explosion**  
 404 **only (left) or shock only (right)**

405 Finally, summing both contributions of the arc shock pressure coming from outside the LSP  
 406 and the explosion of the LSP, the displacement of the GFRP panel, protected with ECF195,  
 407 unpainted and subjected to lightning waveform D is well simulated (see Figure 21). The decay  
 408 time for the explosion is inversely proportional to the peak pressure and the minimum decay  
 409 time in the centre is equal to  $0.85\mu\text{s}$ . A comparison of rear face deflections with the LSP  
 410 surface explosion alone and with the addition of the shock wave is presented in Figure 21.

411 Since the explosion is quickly released, the overpressure generated on the panel is limited,  
412 hence the need to take into account the shock wave overpressure which lasts longer.

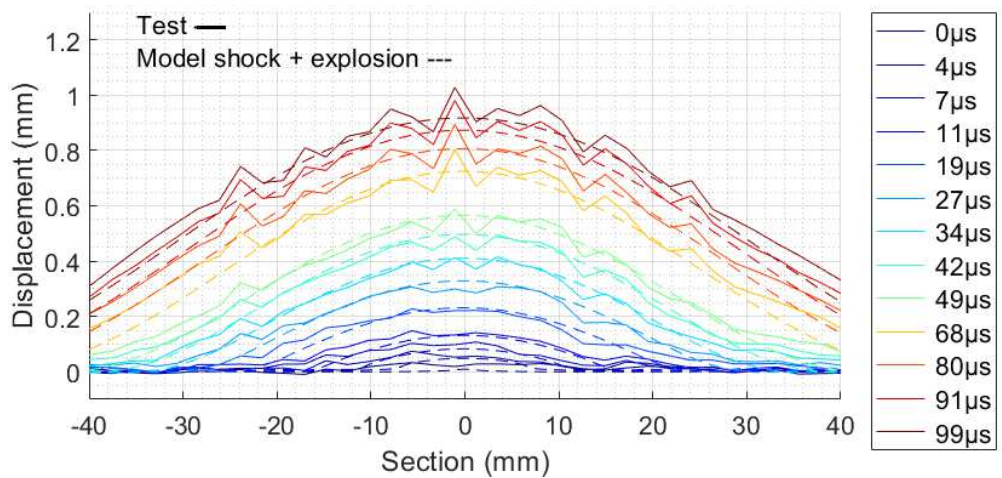

413

414 **Figure 21 GFRP displacement comparison between free explosion lightning test and simulated contribution of explosion**  
415 **and shock wave**

416 This first step without any confinement due to the paint highlights that the approach of the  
417 overpressure due to the explosion as a free shock wave is a fairly good hypothesis but the  
418 shock wave due to the lightning arc generation cannot be neglected. In order to support the  
419 validation of this approach, other configuration of lightning strike protection with a different  
420 profile of explosion is necessary.

421

#### 422 **4.1.2. Confined surface explosion**

423 In a second step, we will now consider a more complex configuration: the displacement of a  
424 GFRP panel, protected with ECF195 and painted. For this case, the deflection of the panel  
425 will be enhanced since the surface explosion is confined by the presence of the paint. Adding  
426 only the same pressure as for an unpainted plate subjected to the shock is no longer valid  
427 because the paint confines the explosion pressure which is also different due to the arc  
428 constriction. The space-time distribution comes from the vaporisation profile measurement

429 [13]. It is therefore necessary to propose another method to estimate the pressure decay  
 430 after the maximum value given by the explosion.  
 431 In order to compare the influence of different explosion profiles with the lightning test  
 432 result, we chose to consider two criteria of the panel displacement. First, the maximum rear  
 433 face displacement which occurs at the centre and second, the maximum of the deflection  
 434 slope  $\epsilon$  as defined in Figure 22, will be recorded. The maximum slope is computed on the  
 435 horizontal and central cross section of the centre point displacement profile.

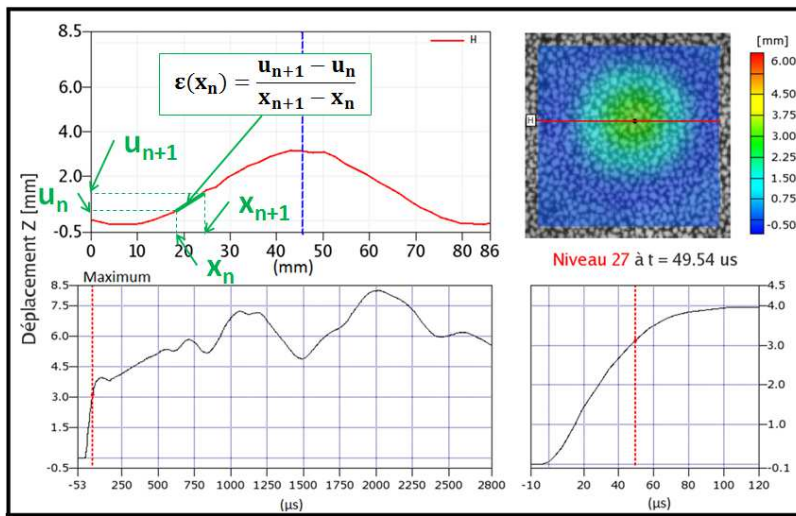

436  
 437 **Figure 22 Maximum strain definition**

438 Since the effect of the confinement on the explosion is not fully known, different pressure  
 439 decay waveforms are considered and implemented as a surface load through a VDLOAD. The  
 440 first configuration sets a constant decay time  $\Delta t_{decay}$  for all elementary loads, whatever the  
 441 pressure amplitude. The different decay times considered were 25, 20, 15, 10 and  $3.2\mu s$ . The  
 442 pressure decay followed the defined law, illustrated in Figure 17:

$$P(t) = P_{exp} e^{-\frac{(t-t_{explosion})}{\Delta t_{decay}}} \times \left( 1 + \frac{(t-t_{explosion})}{\Delta t_{decay}} \right) \quad 12$$

443  
 444 On Figure 23, it is clearly visible that a uniform decay time cannot generate the equivalent  
 445 overpressure. Compared to the test, the max slope is too steep in the early stage as for the

446 maximum displacement. The configuration that is closest to the maximum of displacement  
 447 and slope in the latest stage is the configuration with 15 $\mu$ s of decay. This approach cannot  
 448 represent the overpressure generated on the whole surface. The paint will be ejected  
 449 depending on the stress generated by the overpressure on the paint. As this overpressure  
 450 decreases with the current density decrease in the ECF, the paint will take longer and longer  
 451 to be ejected. The decay time will thus increase with the increase of distance from the  
 452 centre [13].

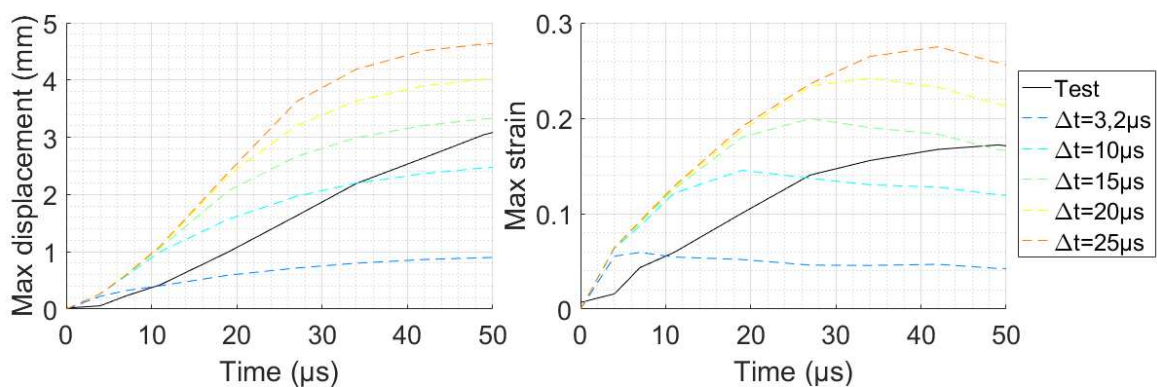

453  
 454 **Figure 23 Overpressure sensitivity analysis with constant decay time**

455 The second configuration considered has a decay time  $\Delta t_{\text{decay}}$  which increases with the  
 456 inverse of the pressure decrease. Several values chosen a priori were considered: 1, 2, 3, 5  
 457 and 10 $\mu$ s. As shown in Figure 24, the law which provides the closest deflection behaviour is  
 458 the one with the minimum decay of 3 $\mu$ s in the centre but again, the max slope and  
 459 displacement are higher in the early stage.

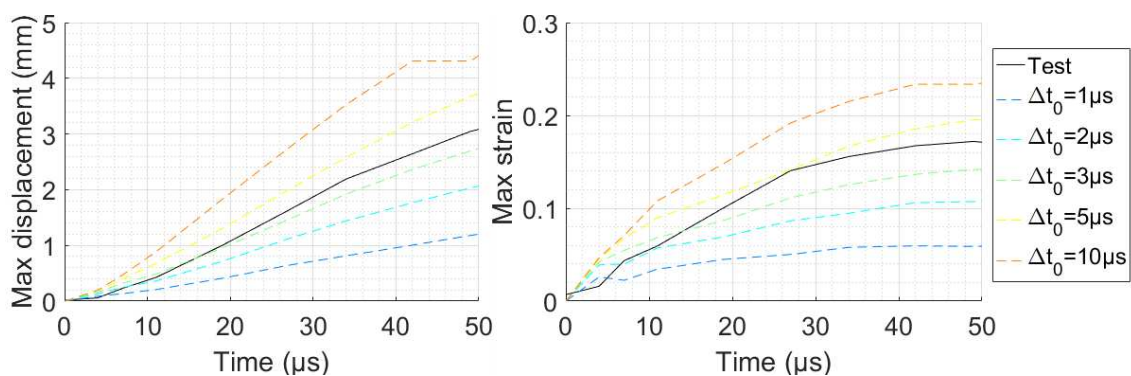

460  
 461 **Figure 24 Sensitivity analysis of overpressure with inverse decay law – max strain**

462 For this configuration, no shock wave is applied since its contribution cannot be applied  
 463 directly on the panel, no matter what the configuration of the explosion since the ejection of  
 464 the paint will disturb the overpressure applied after the shock front. It is too complex to  
 465 simply add it as another contributor of the total overpressure to the LSP explosion. In our  
 466 approach, we simulate a confinement of the paint with a chosen decay time and introducing  
 467 the shock wave would not make a lot of sense. This approximation should not increase the  
 468 error significantly since the deflection due to the lightning arc shock wave on the GFRP panel  
 469 is less than a maximum of 0.5mm after 100µs compared to a total deflection of almost 4mm  
 470 at the same time when there is a confinement with 400µm of paint. The final decay law  
 471 chosen for this specification configuration is:

$$\begin{cases} \Delta t_{decay} = \Delta t_0 \left( \frac{P_{max}}{P_{exp}} \right)^\alpha \\ \Delta t_0 = 3 \mu s \text{ and } \alpha = 0.8 \end{cases} \quad 13$$

472  
 473  $P_{max} = \max(P_{exp})$  is the maximum pressure explosion reached in the centre where the current  
 474 density in the copper wire is the highest.  $\Delta t_0$  is the decay time in the centre and the shortest  
 475 one to represent the fastest paint release due the highest explosion pressure.  
 476 The parameter  $\alpha$  drives the decay time increase with the explosion pressure decrease as  
 477 shown in Figure 25:

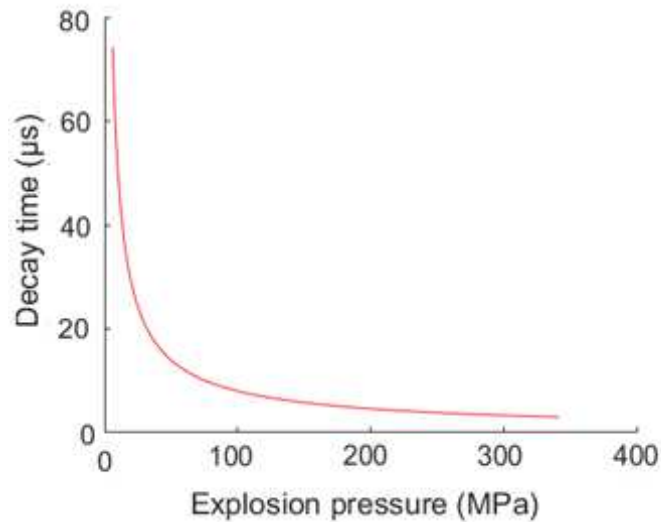

478

479

**Figure 25 Decay time as a function of the explosion pressure**

480 In addition, the pressure profile was linearized as shown previously in Figure 12. This pressure

481 profile is the highest in the centre in one point. However, this is not related to any physical

482 phenomenon. Therefore, the pressure load applied in the centre will be on a disk

483 corresponding to the first measured disk in the back light measurement of the vaporisation

484 profile. The diameter of this disk is smaller than 4mm.

485 The deflection measurement of the GFRP panel protected with ECF195 and confined by

486 400µm of paint during the lightning test performed with WFD is compared with our

487 simulation with the VDLOAD following the decay law defined in Equation 6 36 and is

488 presented in Figure 26:



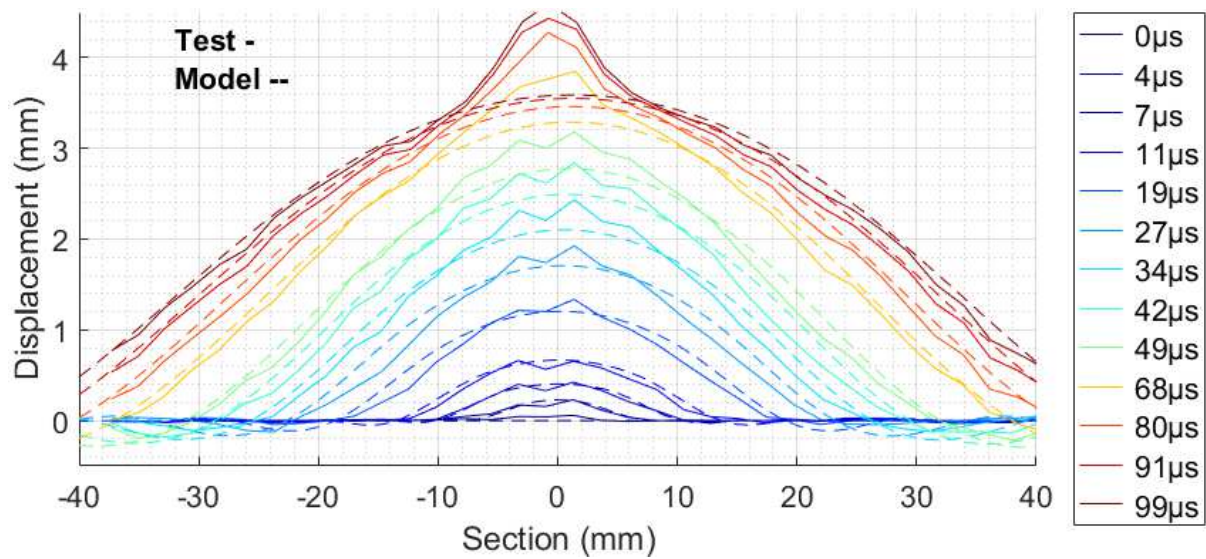

490

491 **Figure 26 GFRP displacement due to ECF195 explosion confined by 400µm of paint with WFD: Test vs shell**

492 The small bump than can be observed in the central area of the test panel deflection is likely  
 493 related to the ejection of the paint used for the DIC pattern. This disturbs the profile  
 494 reconstruction but should not be interpreted as a real local displacement. The deflection  
 495 profiles between the test and the model are fairly similar. The maximum and the width of  
 496 displacement are very close. The only main differences concern the maximum strain, as  
 497 defined in Figure 22, and the waves on each side of the main deflection which are more  
 498 pronounced in the model than in the test. But this is likely to have second order effect on  
 499 the damage generation.

500 The maximum amplitudes of the explosion generated by each ECF wire are of key  
 501 importance in determining the overpressure profile but this is also the case for the decay  
 502 profile. The sensitivity analyses presented above are extracted from a modelling considering  
 503 several decay laws. In order to build a more predictive approach without a supposed decay  
 504 law, it will be necessary to simulate the confining effect of the paint and the mechanical  
 505 constraints necessary to eject the paint. For this purpose, mechanical characterization tests  
 506 of the paint and of the paint adhesive resistance are necessary.

#### 507 **4.2. Effect on a CFRP laminate**

508 The interest of the work done previously was to study the deflection of a panel that has no  
509 interaction with the lightning arc. A GFRP panel is highly resistive, therefore all the current  
510 from the lightning arc will flow in the LSP, leading to its explosion. The comparison between  
511 the simulated deflection from our VDLOAD model and the test results presented fairly good  
512 agreement. The next step is now to analyse the effect of this overpressure profile on a CFRP  
513 structure for which the interaction with the arc is more complex, especially with the  
514 presence of paint that will constrain the arc and lead to current injection into the first plies  
515 of the CFRP. The current flow in the CFRP which can generate internal damage due to  
516 electro-thermal effects was not considered. As explained in 1.2, the contribution of these  
517 effects are supposed negligible in the overall overpressure that will lead to mechanical  
518 damage in the composite. Considering now the painted configuration, we can observe on  
519 Figure 27 that the deflection profiles are fairly similar between the test of a painted laminate  
520 and the simulation of an elastic laminate in the early stages, but not after  $60\mu\text{s}$ . With this  
521 simulation with a simple elastic law, since no damage is allowed, the stiffness of the panel is  
522 kept constant. But we know that damage and delamination occur early during the lightning  
523 test. This delamination could explain the higher deflection profile for the test that is related  
524 to the internal damage that reduces the global flexural rigidity of the panel which would  
525 increase the deflection of the panel. This is a hypothesis but other contributors could  
526 possibly modify the surface load as the arc root constriction which could locally increase the  
527 constraint. This would require further investigations.



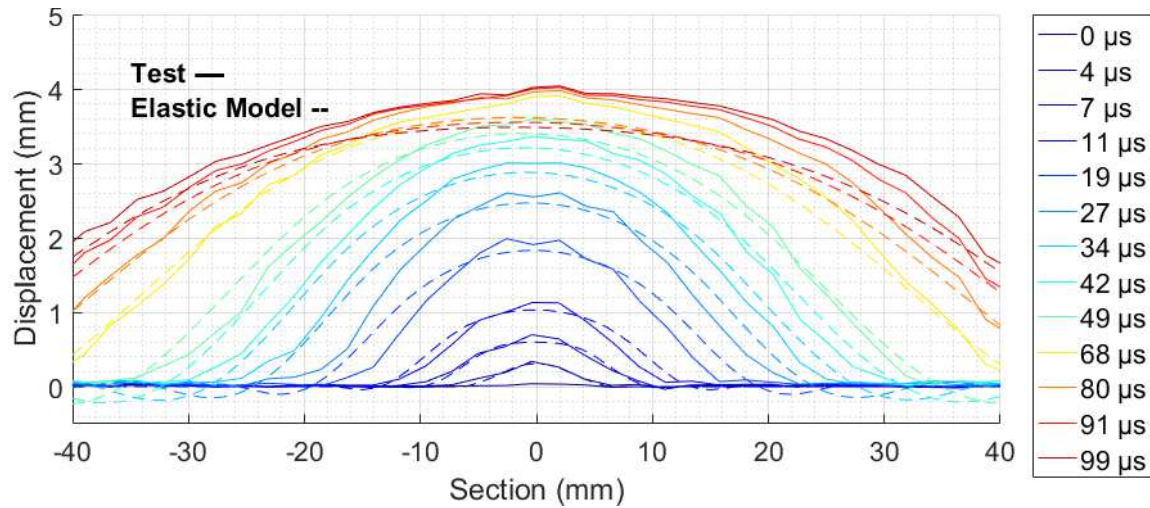

528

529 **Figure 27 CFRP displacement due to ECF195 explosion confined by 400μm of paint with WFD: Test vs shell**

530 The hypothesis considering that the internal damage of CFRP due to the current flow into  
 531 the structure can be neglected in the assessment of the total mechanical constraints due to  
 532 lightning strike tends to be validated by this work. Still, the deflection produced by the load  
 533 profile validated previously presents some differences with the test which will required  
 534 additional investigation in the current distribution between the CFRP and the LSP.

### 535 **4.3. Effect of explosion confinement**

536 As explained previously, the paint thickness has an influence on the confinement of the LSP  
 537 explosion. In the previous work, we defined a confinement law for the pressure considering  
 538 400μm of paint defined in Equation 12 and 13. In order to define the parameters of this law,  
 539 a sensitivity analysis was necessary, requiring the performance of many model  
 540 computations. However, this confinement law will be different with another paint thickness.  
 541 In our lightning test campaign, we assessed the damage and deflection of a CFRP panel  
 542 protected by ECF195 with different paint thicknesses: 250, 400 and 1000μm. In a first simple  
 543 approach, we consider the effect of the paint on the confinement based on a linear  
 544 relationship between the initial decay time and the paint thickness:

$$\begin{cases} \Delta t_{0\delta\mu m} \\ \Delta t_{0\beta\mu m} \end{cases} = \frac{\delta\mu m}{\beta\mu m} \quad 14$$

545

546 The power decay law  $\alpha$  was kept identical at 0.8 for all the paint configurations. In addition  
547 to adapting the pressure decay law for the pressure amplitude, we used the vaporisation  
548 profile measured for the spatio-temporal distribution [13]. The distribution obtained with  
549 200 $\mu\text{m}$  of paint, which is close to a diamond shape, was used for the CFRP configuration with  
550 250 $\mu\text{m}$  of paint. The distribution with a paint thickness of 550 $\mu\text{m}$  is close to an axisymmetric  
551 evolution which means that a higher paint thickness will not change the vaporisation profile  
552 significantly. Therefore, this distribution was used for the CFRP configuration with 1000 $\mu\text{m}$   
553 of paint. Again, the model used here does not consider damage as it leads to disturbance in  
554 the displacement. As with our reference configuration with 400 $\mu\text{m}$  of paint, the  
555 displacement profile is well predicted by this confinement law dependent on paint thickness,  
556 as shown in Figure 28:

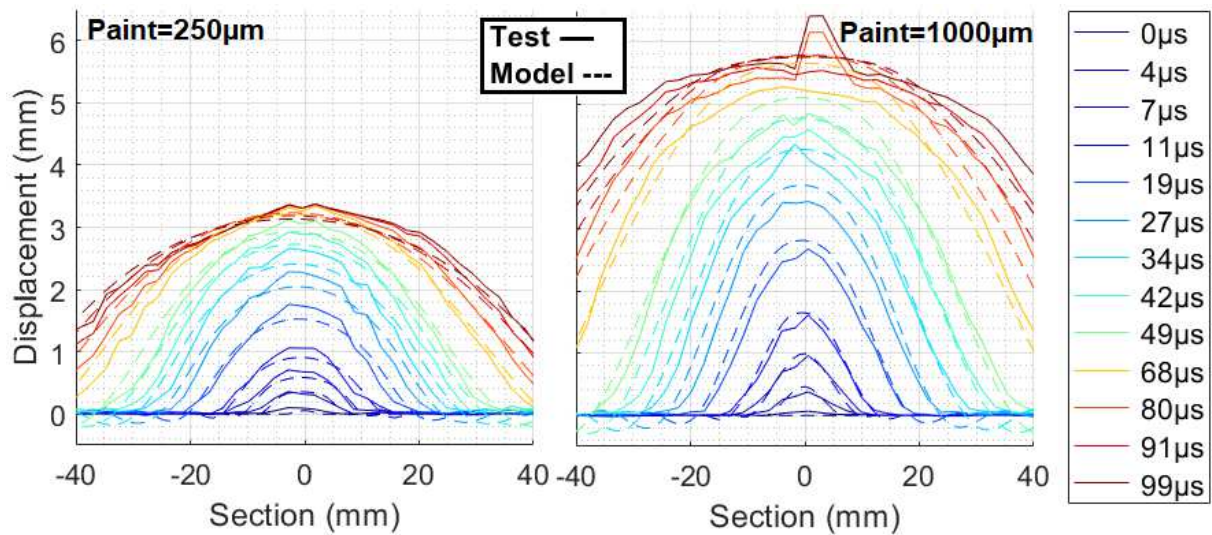

557

558 **Figure 28 Deflection profile comparison between test and model for different paint thicknesses**

559 The pressure decay due to confinement can be predicted with different paint thicknesses.  
560 However, the confinement of the explosion is due, on the one hand, to the paint layer as we  
561 demonstrated, but also to the CFRP substrate on the other hand. Considering now a CFRP  
562 substrate twice as thick as our baseline, we can assess the influence of the substrate

563 stiffness in the explosion confinement. If we apply the same mechanical load as our  
 564 reference configuration (CFRP 13 plies + ECF195 + 400 $\mu$ m of paint) on a configuration that is  
 565 twice as thick (CFRP 26 plies + ECF195 + 400 $\mu$ m of paint), the deflection profile is higher than  
 566 expected, as illustrated in Figure 29:

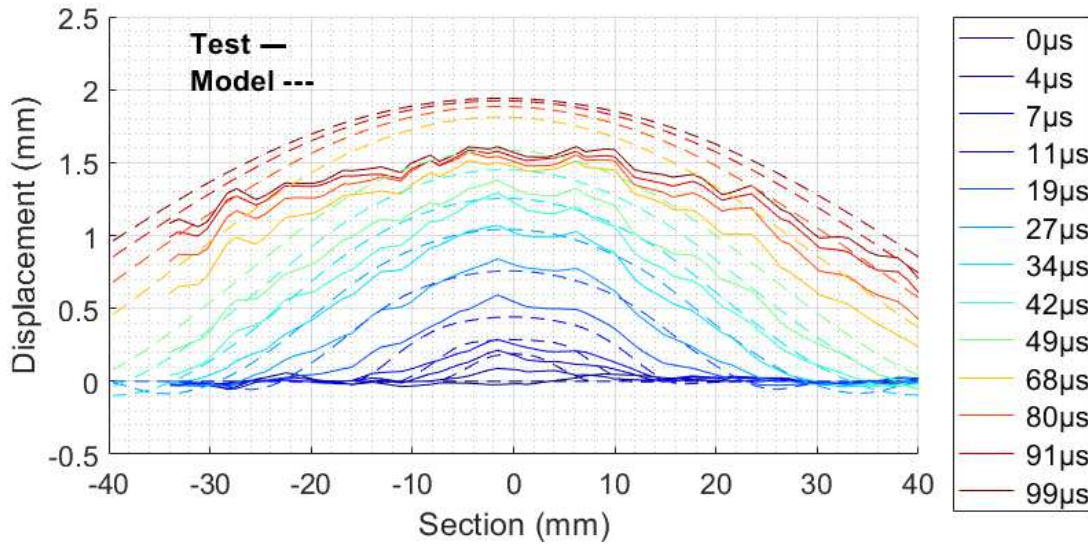

567  
 568 **Figure 29 CFRP thick configuration (EDIFISS 100) comparison between test and shell model with reference VDLOAD**

569 A substrate with a higher stiffness sustains the pressure from the explosion more,  
 570 transferring a higher stress to the paint layer on the top. The paint is ejected more quickly,  
 571 releasing the pressure of the explosion. This theory is illustrated in Figure 30 below:

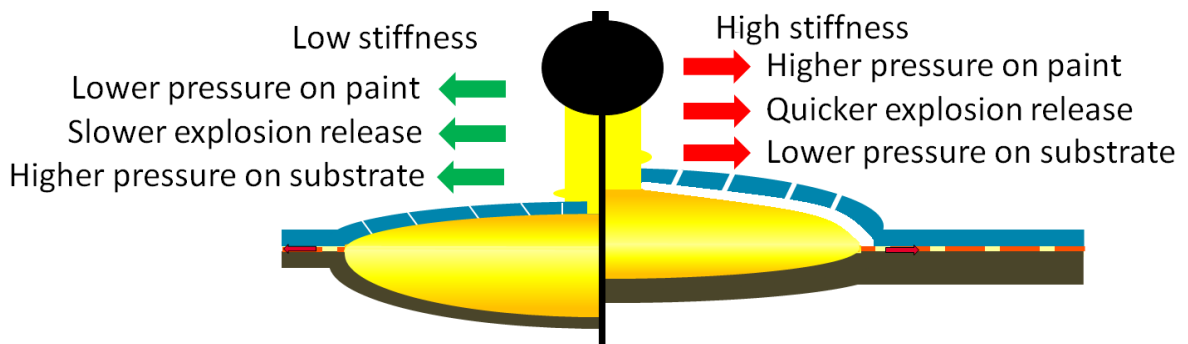

573  
 574 **Figure 30 Substrate stiffness influence on explosion release**

575 We can use the laminate theory [30], as explained in 1.2.1, to compare the bending modulus  
 576 of our reference CFRP panel made of 13 plies and its thicker configuration made of 26 plies.

577 In this case, the modulus  $E_f$  increases from 27GPa to 43GPa. As for the paint thickness  
 578 impact, we propose to decrease the decay time  $\Delta t_0$  with the ratio of  $E_f$  for the thick  
 579 configuration. With the introduction of the influence of the panel bending stiffness in the  
 580 confinement effect, the mechanical load tends to be more representative. As illustrated in  
 581 Figure 31, the deflection of the panel due to this adapted mechanical load shows better  
 582 agreement with the test measurement.

583

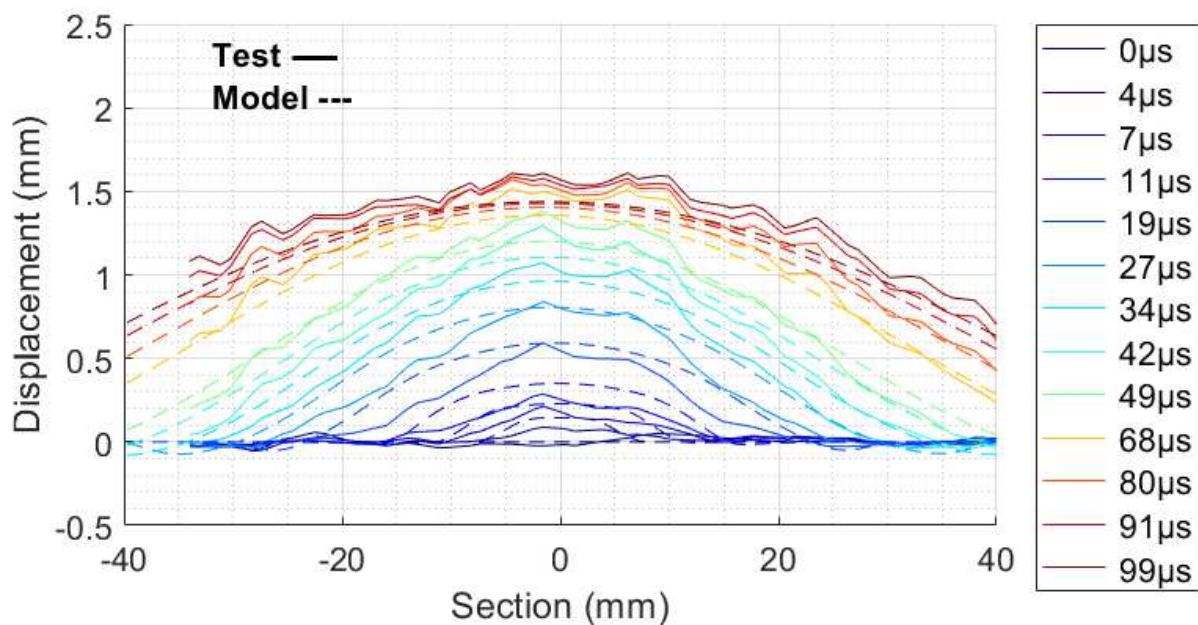

584

585 **Figure 31 CFRP thick configuration (EDIFISS 100) comparison between test and shell model with adapted VDLOAD**

586 On the same principle, we considered a CFRP structure with a different ply grade i.e., the  
 587 thickness of the ply is 184 $\mu$ m instead of 127 $\mu$ m for the reference. But the construction  
 588 comprises 9 plies (90/45/-45/0/90/0/-45/45/90) in order to obtain similar mechanical  
 589 properties. The equivalent bending modulus is only slightly increased from 27GPa to 28GPa,  
 590 therefore the same mechanical load as for the reference was applied. As for the reference,  
 591 the model presents the same deflection in the early stage but the deflection then slows  
 592 down earlier in comparison to the test results (see Figure 32). The construction of the load  
 593 dependent on the bending modulus of the panel predicts fairly correctly the displacement of



594 the panel due to a lightning strike, validating the strong influence of the surface explosion on  
595 the mechanical constraints applied on the structure.

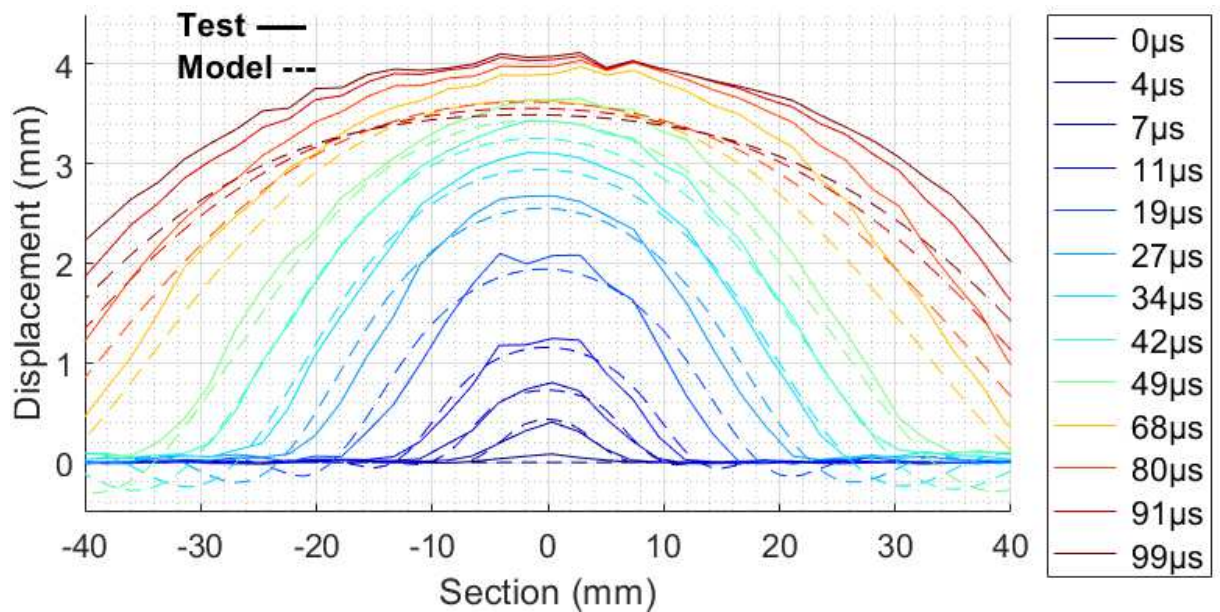

596

597 **Figure 32 CFRP medium grade comparison between test and shell model with reference VDLOAD**

598 This work on the explosion confinement highlights the importance of considering the  
599 lightning load as dependant on the substrate and the paint that will confine the surface  
600 explosion and change the amplitude of the overpressure. This is an important conclusion of  
601 this work. In order to complete this activity, it will be also necessary to assess its influence  
602 on the arc root confinement and therefore on the current distribution and associated  
603 explosion profile. As mentioned before, a model simulating the paint layer and its  
604 mechanical properties and damage is a necessary step in order to predict the overpressure  
605 and avoid the using of a supposed law of pressure distribution and release.

606

## 607 **5. Conclusion**

608 The main objective of this paper was to reproduce the mechanical constraints due to a  
609 lightning strike. We proposed a methodology to simplify this multiphysics phenomenon into

610 a purely mechanical problem. The ability to reproduce the load produced by the lightning  
611 strike is key in order to predict the damage generated by such a phenomenon.

612 From the characterisation of the LSP explosion developed in the previous work which  
613 provided the spatio-temporal distribution of the explosion pressure and its amplitude, we  
614 could build a complete equivalent mechanical load. In a first step, the explosion pressure  
615 was modelled as a pressure applied on the surface of the composite. We built a  
616 methodology to convert this profile into a VDLOAD contained in every face of the substrate  
617 that will be stressed by the surface explosion pressure. The source of the model input was  
618 modified and associated to the user subroutine we developed.

619 In order to validate this model, we chose a set of lightning experimental results which  
620 provide essential data. The panel deflection due to the lightning strike was measured thanks  
621 to a digital image correlation method.

622 The surface explosion and its confinement by paint were studied independently. Thanks to  
623 the use of a GFRP structure which does not divert the lightning current, we were able to  
624 study and calibrate the pressure generated by a confined explosion. Since the relaxation  
625 time couldn't be measured independently, a simple law for the pressure decay time was  
626 therefore developed, dependent on the maximum explosion pressure. This law simulated  
627 the confinement due to the paint which maintains the pressure before being ejected by this  
628 underlying explosion pressure. Our study of different paint thicknesses and panel stiffnesses  
629 demonstrated the dependency of the pressure profile on the confinement. The LSP  
630 explosion is sandwiched by the paint and the composite structure. Therefore, a change in  
631 their mechanical properties will influence its confinement and will maintain, or not, a high  
632 pressure on the structure. We were able to linearly relate the pressure decay law to the

633 variation in stiffness of these parts and predict the panel deflection with this simple  
634 approach.

635 The final objective and the next step are to enable the damage prediction with a mechanical  
636 model considering the surface load defined in this work.

## 637 6. Acknowledgements

638 This research was supported by EDIFISS project and funded by Airbus. DGA-TA is gratefully  
639 thanked for the tests results used in this study. The laboratories ICA and GREMI are  
640 gratefully thanked for their help and collaboration. This work was performed using HPC  
641 resources from CALMIP (Grant 2019-P19051).

## 642 7. References

- 643 [1] Plumer, J. A. *Aircraft Lightning Protection Handbook*. Lightning Technologies, Inc., 1989.
- 644 [2] Bigand, A., Espinosa, C., Bauchire, J. M., Flourens, F., and Lachaud, F. Lightning Damage  
645 Assessment into Composite Based on Surface Explosion and Fiber Breakage. Presented at the  
646 International Conference on Composite Materials (ICCM22), Melbourne (Australia), 2019.
- 647 [3] Abdelal, G., and Murphy, A. "Nonlinear Numerical Modelling of Lightning Strike Effect on  
648 Composite Panels with Temperature Dependent Material Properties." *Composite Structures*,  
649 Vol. 109, 2014, pp. 268–278. <https://doi.org/10.1016/j.compstruct.2013.11.007>.
- 650 [4] Fu, K., Ye, L., Chang, L., Yang, C., and Zhang, Z. "Modelling of Lightning Strike Damage to CFRP  
651 Composites with an Advanced Protection System. Part I: Thermal-Electrical Transition."  
652 *Composite Structures*, Vol. 165, 2017, pp. 83–90.  
653 <https://doi.org/10.1016/j.compstruct.2017.01.008>.
- 654 [5] Foster, P., Abdelal, G., and Murphy, A. "Understanding How Arc Attachment Behaviour  
655 Influences the Prediction of Composite Specimen Thermal Loading during an Artificial  
656 Lightning Strike Test." *Composite Structures*, Vol. 192, 2018, pp. 671–683.  
657 <https://doi.org/10.1016/j.compstruct.2018.03.039>.
- 658 [6] Guo, Y., Dong, Q., Chen, J., Yao, X., Yi, X., and Jia, Y. "Comparison between Temperature and  
659 Pyrolysis Dependent Models to Evaluate the Lightning Strike Damage of Carbon Fiber  
660 Composite Laminates." *Composites Part A: Applied Science and Manufacturing*, Vol. 97, 2017,  
661 pp. 10–18. <https://doi.org/10.1016/j.compositesa.2017.02.022>.
- 662 [7] Wang, F. S., Ji, Y. Y., Yu, X. S., Chen, H., and Yue, Z. F. "Ablation Damage Assessment of Aircraft  
663 Carbon Fiber/Epoxy Composite and Its Protection Structures Suffered from Lightning Strike."  
664 *Composite Structures*, Vol. 145, 2016, pp. 226–241.  
665 <https://doi.org/10.1016/j.compstruct.2016.03.005>.
- 666 [8] Ogasawara, T., Hirano, Y., and Yoshimura, A. "Coupled Thermal-Electrical Analysis for Carbon  
667 Fiber/Epoxy Composites Exposed to Simulated Lightning Current." *Composites Part A: Applied  
668 Science and Manufacturing*, Vol. 41, No. 8, 2010, pp. 973–981.  
669 <https://doi.org/10.1016/j.compositesa.2010.04.001>.
- 670 [9] Dong, Q., Guo, Y., Chen, J., Yao, X., Yi, X., Ping, L., and Jia, Y. "Influencing Factor Analysis Based  
671 on Electrical-Thermal-Pyrolytic Simulation of Carbon Fiber Composites Lightning Damage."

- 672 *Composite Structures*, Vol. 140, 2016, pp. 1–10.  
673 <https://doi.org/10.1016/j.compstruct.2015.12.033>.
- 674 [10] Chippendale, R. *Modelling of the Thermal Chemical Damage Caused to Carbon Fibre*  
675 *Composites*. University of Southampton, 2013.
- 676 [11] Sun, J., Li, Y., Tian, X., Duan, Y., Yao, X., and Wang, B. “Experimental and Numerical Analysis of  
677 Damage Mechanisms for Carbon Fiber-Reinforced Polymer Composites Subjected to Lightning  
678 Strikes.” *Engineering Failure Analysis*, Vol. 118, 2020, p. 104894.  
679 <https://doi.org/10.1016/j.engfailanal.2020.104894>.
- 680 [12] Sun, J., Tian, X., Li, Y., Wu, Y., Duan, Y., Chen, J., Ziegmann, G., Rong, M., Yao, X., and Wang, B.  
681 “Lightning Strike-Induced Dynamic Conduction Characteristics and Damage Behavior of  
682 Carbon Fiber-Reinforced Polymer Composites.” *Composite Structures*, Vol. 275, 2021, p.  
683 114391. <https://doi.org/10.1016/j.compstruct.2021.114391>.
- 684 [13] Bigand, A., Espinosa, C., and Bauchire, J.-M. Lightning Surface Explosion Impact Study on  
685 Damage Generation into Composite. Presented at the ICOLSE 2019, Wichita (USA), 2019.
- 686 [14] Lee, J., Lacy Jr., T. E., and Pittman Jr., C. U. “Coupled Thermal Electrical and Mechanical  
687 Lightning Damage Predictions to Carbon/Epoxy Composites during Arc Channel Shape  
688 Expansion.” *Composite Structures*, Vol. 255, 2021, p. 112912.  
689 <https://doi.org/10.1016/j.compstruct.2020.112912>.
- 690 [15] Ma, X., Wang, F., Wang, Z., Li, Y., and Xu, B. “Thermal Dynamic Damage of Aircraft Composite  
691 Material Suffered from Lightning Channel Attachment Based on Moving Mesh Method.”  
692 *Composites Science and Technology*, Vol. 214, 2021, p. 109003.  
693 <https://doi.org/10.1016/j.compscitech.2021.109003>.
- 694 [16] Karch, C. Contributions of Lightning Current Pulses to Mechanical Damage of CFRP Structures.  
695 Presented at the ICOLSE, Toulouse, 2015.
- 696 [17] Chemartin, L., Lalande, P., Peyrou, B., Chazottes, A., Elias, P. Q., Delalondre, C., Cheron, B. G.,  
697 and Lago, F. “Direct Effects of Lightning on Aircraft Structure: Analysis of the Thermal,  
698 Electrical and Mechanical Constraints.” *AerospaceLab*, No. 5, 2012, p. p-1.
- 699 [18] Soulas, F., Espinosa, C., Lachaud, F., Guinard, S., Lepetit, B., Revel, I., and Duval, Y. “A Method  
700 to Replace Lightning Strike Tests by Ball Impacts in the Design Process of Lightweight  
701 Composite Aircraft Panels.” *International Journal of Impact Engineering*, Vol. 111, 2018, pp.  
702 165–176.
- 703 [19] Gineste, P.-N., Clerc, R., Castanie, C., Andreu, H., and Buzaud, E. Assessment of Lightning  
704 Direct Effects Damages by Modelling Techniques. Presented at the ICOLSE, Pittsfield, USA,  
705 2009.
- 706 [20] Kawakami, H. *Lightning Strike Induced Damage Mechanisms of Carbon Fiber Composites*.  
707 Ph.D. University of Washington, United States -- Washington, 2011.
- 708 [21] Muñoz, R., Delgado, S., González, C., López-Romano, B., Wang, D.-Y., and Llorca, J. “Modeling  
709 Lightning Impact Thermo-Mechanical Damage on Composite Materials.” *Applied Composite*  
710 *Materials*, Vol. 21, No. 1, 2014, pp. 149–164. <https://doi.org/10.1007/s10443-013-9377-9>.
- 711 [22] Lee, J., Lacy, T. E., and Pittman, C. U. “Lightning Mechanical Damage Prediction in  
712 Carbon/Epoxy Laminates Using Equivalent Air Blast Overpressure.” *Composites Part B:*  
713 *Engineering*, Vol. 212, 2021, p. 108649. <https://doi.org/10.1016/j.compositesb.2021.108649>.
- 714 [23] Lee, J., Lacy, T. E., Pittman, C. U., and Reddy, J. N. “Numerical Estimations of Lightning-Induced  
715 Mechanical Damage in Carbon/Epoxy Composites Using Shock Wave Overpressure and  
716 Equivalent Air Blast Overpressure.” *Composite Structures*, Vol. 224, 2019, p. 111039.  
717 <https://doi.org/10.1016/j.compstruct.2019.111039>.
- 718 [24] Lepetit, B., Escure, C., Guinard, S., Revel, I., and Peres, G. Thermo-Mechanical Effects Induced  
719 by Lightning on Carbon Fiber Composite Materials. Presented at the ICOLSE, Oxford, UK, 2011.
- 720 [25] Soulas, F. *Développement d’un Modèle Mécanique Pour La Prédiction Des Dommages de*  
721 *Panneaux Composites Aéronautiques Soumis à Un Choc Foudre*. Toulouse, ISAE, 2016.
- 722 [26] Kumar, V., Yokozeki, T., Karch, C., Hassen, A. A., Hershey, C. J., Kim, S., Lindahl, J. M., Barnes,  
723 A., Bandari, Y. K., and Kunc, V. “Factors Affecting Direct Lightning Strike Damage to Fiber



- 724 Reinforced Composites: A Review.” *Composites Part B: Engineering*, Vol. 183, 2020, p. 107688.  
725 <https://doi.org/10.1016/j.compositesb.2019.107688>.
- 726 [27] EUROCAE. *ED-84: Aircraft Lightning Environment And Related Test Waveforms*. 1997.
- 727 [28] Lago, F., Fontaine, G., and Larrieu, C. Measurement by a Digital Image Correlation Technique  
728 of the Deflection of Panels Submitted to Lightning Impulse. Presented at the ICOLSE, Oxford,  
729 UK, 2011.
- 730 [29] Jia, S., Wang, F., Xu, B., and Yan, W. “A Developed Energy-Dependent Model for Studying  
731 Thermal Shock Damage and Phase Transition of Composite Reinforced Panel Subjected to  
732 Lightning Strike.” *European Journal of Mechanics - A/Solids*, Vol. 85, 2021, p. 104141.  
733 <https://doi.org/10.1016/j.euromechsol.2020.104141>.
- 734 [30] Gay, D. *Matériaux Composites*. 1997.
- 735 [31] Bigand, A. *Damage Assessment on Aircraft Composite Structure Due to Lightning Constraints*.  
736 Institut Supérieur de l’Aéronautique et de l’Espace, Toulouse, 2020.
- 737 [32] Naghipour, P., Pineda, E. J., and Arnold, S. M. “Simulation of Lightning-Induced Delamination  
738 in Un-Protected CFRP Laminates.” *Applied Composite Materials*, Vol. 23, No. 4, 2016, pp. 523–  
739 535. <https://doi.org/10.1007/s10443-016-9472-9>.
- 740 [33] Karch, C., Schreiner, M., Honke, R., and Wolfrum, J. Shock Waves from a Lightning Discharge.  
741 Presented at the 2018 34th International Conference on Lightning Protection (ICLP), 2018.  
742