



HAL
open science

Prognosis of fuel cell degradation under different applications using wavelet analysis and nonlinear autoregressive exogenous neural network

Kui Chen, Salah Laghrouche, Abdesslem Djerdir

► To cite this version:

Kui Chen, Salah Laghrouche, Abdesslem Djerdir. Prognosis of fuel cell degradation under different applications using wavelet analysis and nonlinear autoregressive exogenous neural network. *Revista Brasileira de Economia*, 2021, 179, pp.802 - 814. hal-03549359

HAL Id: hal-03549359

<https://hal.science/hal-03549359>

Submitted on 31 Jan 2022

HAL is a multi-disciplinary open access archive for the deposit and dissemination of scientific research documents, whether they are published or not. The documents may come from teaching and research institutions in France or abroad, or from public or private research centers.

L'archive ouverte pluridisciplinaire **HAL**, est destinée au dépôt et à la diffusion de documents scientifiques de niveau recherche, publiés ou non, émanant des établissements d'enseignement et de recherche français ou étrangers, des laboratoires publics ou privés.

1 Prognosis of fuel cell degradation under different
2 applications using wavelet analysis and nonlinear
3 autoregressive exogenous neural network

4 Kui Chen, Salah Laghrouche, Abdesslem Djerdir

5 *FEMTO-ST, UMR CNRS 6174, and FCLAB, FR CNRS 3539, Université Bourgogne*
6 *Franche-Comté, Belfort/UTBM 90000, France*

7 **Abstract**

8 This paper presents the degradation prognosis of Proton Exchange Mem-
9 brane Fuel Cell (PEMFC) operated under several conditions based on the
10 combination of two types of data: data from postal fuel cell hybrid elec-
11 tric vehicles equipped with PEMFC and carrying out their postal delivery
12 missions and PEMFC degradation data from laboratory. The prognosis is
13 based on wavelet analysis and Nonlinear Autoregressive Exogenous Neural
14 Network (NARX). The influences of historical state, operating conditions
15 (load current, relative humidity, temperature, and hydrogen pressure), global
16 degradation trend, and recovery phenomena on the degradation prognosis
17 of PEMFC are considered. Firstly, the raw voltage degraded waveform of
18 PEMFC is decomposed into multiple sub-waveforms by the wavelet analysis.
19 Then, the degradation prognosis of each sub-waveform is made by NARX.
20 Finally, the overall degradation prognosis of PEMFC is gotten by combing
21 the degradation prognosis of each sub-waveform. Experimental results have
22 shown that the novel prognosis method which exploits the two types of data
23 results in a reliable model that covers PEMFC degradation over a wide range
24 of operating conditions. The proposed prognosis method not only can make
25 an accurate degradation prognosis of PEMFC with less learning data but
26 also can use directly the raw experimental data with large fluctuation.

27 *Keywords:* PEM fuel cell; degradation prognosis; wavelet analysis;
28 nonlinear autoregressive exogenous neural network; fuel cell hybrid electric
29 vehicle.

30 1. Introduction

31 With environmental protection and increasing energy demand, sustain-
32 able green energy is regarded as the main direction of future energy devel-
33 opment [1]. The fuel cell directly converts the chemical energy of the fuel
34 into electricity without being restricted by the Carnot cycle [2]. The fuel cell
35 has the advantages of high specific energy, high energy conversion efficiency,
36 no pollution, low noise, many types of fuel, etc [3]. The fuel cell is widely
37 used in cogeneration, power plants, fuel cell electric vehicles, portable power
38 systems, distributed generation, and other fields [4]. Due to the fact that
39 its distinguishing features include low operating temperature, lower pressure
40 ranges, small size, and no chemical hazards to the human body, Proton Ex-
41 change Membrane Fuel Cell (PEMFC) has received high attention from the
42 government, industry, and academia [5]. Currently, PEMFC is regarded as
43 the most likely candidate for transportation and other mobile applications [6].
44 PEMFC can avoid some battery problems, such as the use of pollutant mate-
45 rials and long charging time [7]. However, durability and cost seriously affect
46 the large-scale commercial application of PEMFC [8]. The degradation of
47 carbon support and Platinum (Pt) nanoparticles will cause the reduction in
48 the performance of PEMFC [9]. The maximum service life of PEMFC un-
49 der transportation conditions is around 3000 h, while the expected life of
50 PEMFC is at least 5000 h for commercial transportation applications [10].
51 Prognostics and health management can predict the degradation of PEMFC
52 and provide an appropriate maintenance plan to reduce the cost and improve
53 the durability of PEMFC [11]. Therefore, the degradation prognosis is very
54 important for the operation and maintenance of PEMFC [12].

55 The degradation of PEMFC is caused by the degradation of its main com-
56 ponents [13]. The main components of PEMFC are bipolar plates, Gas Dif-
57 fusion Layers (GDL), electrodes, catalysts, and proton exchange membranes.
58 In the long-term operation of PEMFC, these components will experience dif-
59 ferent degradations [14]. The bipolar plates undergo corrosion, fractures,
60 and deformation. The GDL undergoes structural changes, porosity loss, and
61 hydrophobicity loss. The electrodes and catalysts undergo Pt dissolution,
62 Pt agglomeration, Pt oxidation, and carbon corrosion. The proton exchange
63 membranes undergo decomposition, creep, fatigue, and hot-dot. The degra-
64 dation of PEMFC usually causes the output voltage to drop, the output
65 power to decrease, the internal resistance to increase, etc [15]. Therefore, the
66 output voltage, output power, and internal resistance are often selected to

67 represent the degradation state of PEMFC [16]. In this paper, the output
68 voltage is selected as a degradation indicator of PEMFC because it has been
69 measured to monitor the PEMFC performance.

70 The prognosis methods of PEMFC are usually divided into 3 categories:
71 model-driven methods, data-driven methods, and hybrid methods [17]. The
72 model-driven methods make the degradation prognosis of PEMFC based on
73 the empirical or semi-empirical degradation model of PEMFC [18]. The
74 degradation trends are simulated through the empirical or semi-empirical
75 degradation model of PEMFC. Three empirical degradation models com-
76 bined with particle filter are proposed to forecast the degradation and Re-
77 maining Useful Life (RUL) of PEMFC [19]. The semi-empirical degradation
78 model combined with the extended Kalman filter is presented to make the
79 degradation prognosis of PEMFC [20]. The Gaussian degradation model
80 combined with an unscented particle filter is developed to make the state of
81 health estimation and RUL prognosis for PEMFC [21].

82 The PEMFC is a complex, multivariable, and strongly coupled dynamic
83 nonlinear system. The degradation of PEMFC involves the multi-scale (nanome-
84 ter scale, cell scale, and system scale) and multi-material (carbon fibers,
85 metal, Pt, and Nafion membrane). It is difficult to build the accurate math-
86 ematical degradation model of PEMFC because its degradation mechanism
87 is not fully known [22].

88 The data-driven methods make the degradation prognosis of PEMFC by
89 learning the degradation trend from recorded aging data based on artificial
90 neural network and fuzzy system [23]. The echo state network is proposed
91 to estimate the performance degradation and RUL for PEMFC [24]. The
92 long short-term memory recurrent neural network is applied to predict the
93 degradation and remaining life of PEMFC [25]. The self-adaptive relevance
94 vector machine method is developed to predict the performance degrada-
95 tion of PEMFC [26]. The adaptive neuro-fuzzy inference system method is
96 proposed to forecast degradation in PEMFC [27].

97 The hybrid methods integrate the advantages of model-driven methods
98 and data-driven methods to make the degradation prognosis of PEMFC [28].
99 The hybrid method based on three empirical degradation models and the
100 least square support vector machine method is presented to make the degra-
101 dation and RUL prognosis for PEMFC [29]. The autoregressive and moving
102 average model integrated the time delay neural network is developed to pre-
103 dict the performance degradation of PEMFC [30]. A semi-empirical degrada-
104 tion model integrated the automatic machine learning algorithm is proposed

105 to estimate the degradation trend and forecast the RUL for PEMFC [31].
106 Compared with model-driven methods and data-driven methods, the hybrid
107 methods require the most computation.

108 The degradation prognosis of PEMFC in most literature studies consider
109 the influence of the historical state, and rarely consider the impact of operat-
110 ing conditions on degradation prognosis. However, the operating conditions
111 have a great influence on the performance of PEMFC [32]. Water flooding
112 in the bipolar plates and membrane electrode assembly can cause gas starva-
113 tion and may accelerate the corrosion of bipolar plates, electrodes, catalysts,
114 GDL, and membrane [33]. Dehydration of membrane causes high membrane
115 resistance, tearing, and cracking [34]. When gas starvation occurs at the
116 cathode, it will cause the coalescence of the catalyst [35]. When gas starva-
117 tion occurs at the anode, it will cause carbon support corrosion [35]. Gas
118 starvation may cause the change of electrode thickness, uneven current and
119 voltage distribution, porous structure collapse, and reverse polarity [36]. The
120 temperature has a certain effect on water saturation pressure and membrane
121 hydration [37]. The temperature will affect the water distribution, gas dis-
122 tribution, and chemical reactions, which cause hot spots in the membrane
123 and accelerate the decay of the catalyst [38]. Frequently changing load brings
124 the challenges for water management, thermal management, and gas manage-
125 ment, which may cause gas starvation, water flooding, dehydration, hot spot,
126 etc [39]. The start-stop process causes the increase of resistance, high-load
127 operating conditions may accelerate the dissolution of Pt, and rated operat-
128 ing condition leads to a decrease in the electrochemically active area [40]. The
129 historical state and operating conditions including the load current, relative
130 humidity, temperature, and hydrogen pressure are considered by Nonlinear
131 Autoregressive Exogenous Neural Network (NARX) in this paper. NARX
132 is a recurrent dynamic neural network, which has good dynamic character-
133 istics and anti-interference ability in the nonlinear problems of time series
134 prediction.

135 The degradation of PEMFC includes global degradation trend (irreversible
136 degradation phenomena) and recovery phenomena [41]. The global degra-
137 dation trend refers to the irreversible loss of PEMFC performance as the
138 PEMFC runs for a long time [42]. The global degradation trend is caused by
139 the degradation of bipolar plates, electrodes, catalysts, gas diffusion layers,
140 and membranes. Recovery phenomena refer to a certain degree recovery per-
141 formance of PEMFC, when the PEMFC undergoes stop/start, characteristic
142 test, or large changes in operating conditions [43]. For example, when the

143 gas supply is sufficient, the PEMFC performance recovers after gas starva-
144 tion is improved [44]. Recovery phenomena are the transient process during
145 the degradation of PEMFC. Most of the previous prognosis methods only fo-
146 cused on the global degradation trend, while both global degradation trend
147 and recovery phenomena are considered by wavelet analysis in this paper.

148 Wavelet analysis is an effective time-frequency analysis method. It has
149 the ability to characterize signal local information in time-frequency domain,
150 and is widely used in image compression, signal processing, and information
151 extraction.

152 The existing prognosis methods rarely use directly raw experimental data
153 to predict the degradation of PEMFC. Because the raw experimental data
154 of PEMFC includes complex fluctuations and recovery phenomena. The raw
155 experimental data of PEMFC in different applications is directly used to
156 predict the degradation in this paper.

157 Considering the historical state, operating conditions, and different degra-
158 dation phenomena, this paper presents the degradation prognosis method
159 based on wavelet analysis and NARX for PEMFC operated under different
160 applications. The main contributions are summarized as follows:

- 161 1. The proposed prognosis method makes degradation prediction of PEMFC
162 based on the raw experimental data.
- 163 2. The NARX, which considers the historical state and exogenous inputs
164 (load current, relative humidity, temperature, and hydrogen pressure), is
165 applied to the degradation prognosis of PEMFC operated under different
166 applications.
- 167 3. The global degradation trend and recovery phenomena of PEMFC are
168 analyzed by wavelet analysis, which can effectively improve the accuracy
169 of the degradation prognosis of PEMFC.
- 170 4. Experimental results show that this presented method is robust and can be
171 applied to the degradation prognosis of PEMFC in different applications.

172 In Section 2, the durability tests of PEMFC operated under different
173 applications are presented. Section 3 proposes the degradation prognosis of
174 PEMFC based on NARX and W-NARX. Section 4 presents the validation
175 of the method on the basis of experimental results. Moreover, these results
176 are compared with NARX and different learning data. Section 5 provides
177 Conclusions.

178 **2. Durability tests of PEMFC operated under different applica-**
179 **tions**

180 *2.1. Durability test of PEMFC in FCHEV operated under real conditions*

181 The durability test of PEMFC is made in Fuel Cell Hybrid Electric Vehicle
182 (FCHEV) operated under real conditions. The MOBYPOST project has de-
183 veloped ten FCHEVs (Fig. 1) to complete commercial mail delivery tasks on
184 the real road [45]. PEMFC and lithium batteries provide power for FCHEV.
185 Integrating lithium batteries into FCHEV can prevent PEMFC from fre-
186 quently starting and shutting down, which reduces the PEMFC degradation
187 and increases its lifetime [46]. The main parameter of PEMFC in FCHEV
188 operated under real conditions is shown in Table 1. In order to control and
189 monitor the PEMFC in FCHEV, the operating conditions including load cur-
190 rent, voltage, relative humidity, temperature, hydrogen pressure, and state of
191 charge of the hydrogen tank and battery are measured by FCHEV electronic
192 control unit every second. PEMFC adopts the open cathode type with nat-
193 ural humidification. In order to avoid flooding, regular purge is conducted
194 in the hydrogen circuit. The stop/start of PEMFC that greatly changes the
195 distribution of water, gas, and heat in the PEMFC stack causes the recovery
196 phenomena.



Figure 1: MOBYPOST fuel cell hybrid electric vehicle

197 *2.2. Durability test of PEMFC operated under quasi-dynamic load current*

198 The durability test of PEMFC operated under a quasi-dynamic load cur-
199 rent is made on the power test platform of FCLAB, as shown in Fig. 2. The

Table 1: The operating conditions of PEMFC in FCHEV operated under real conditions

Parameter	Value
PEMFC weight	2.7 kg
Number of cells	40
Active area	100 cm ²
PEMFC maximum power	1 kW
PEMFC rated current	34 A
PEMFC rated voltage	31 V
Relative humidity	35%-78%
Temperature	50 °C
Hydrogen pressure	0.6 bar

200 quasi-dynamic load current is a constant current of 70 A plus a ripple current
 201 of 7 A. The main parameter of PEMFC operated under the quasi-dynamic
 202 load current is shown in Table 2, more detailed descriptions of the PEMFC
 203 can be found in [47]. In order to control and monitor the PEMFC per-
 204 formance, operating conditions including load current, single cell and stack
 205 voltage, relative humidity, temperature, gas flow, air pressure, and hydro-
 206 gen pressure are measured every half minute. In order to characterize the
 207 health status of the PEMFC, the Electrochemical Impedance Spectroscopy
 208 (EIS) and polarization curve tests are made approximately weekly (0 h, 35
 209 h, 182 h, 343 h, and 515 h). The characteristic test that greatly changes the
 210 distribution of water, gas and heat in the PEMFC stack causes the recovery
 211 phenomena.

212 *2.3. Durability test of PEMFC operated under constant load current*

213 The durability test of PEMFC operated under constant load current is
 214 made on the test platform of FCLAB (Fig. 2). The constant load current is
 215 a constant current of 70A. The main parameter of PEMFC operated under
 216 constant load current is shown in Table 3. The operating conditions including
 217 load current, single cell and stack voltage, relative humidity, temperature, gas
 218 flow, air pressure, and hydrogen pressure are also measured every half minute.
 219 the EIS and polarization curve tests are also made approximately weekly (0
 220 h, 48 h, 185 h, 348 h, 515 h, 658 h, and 823 h). After each characteristic
 221 test, the recovery phenomena of PEMFC are found.

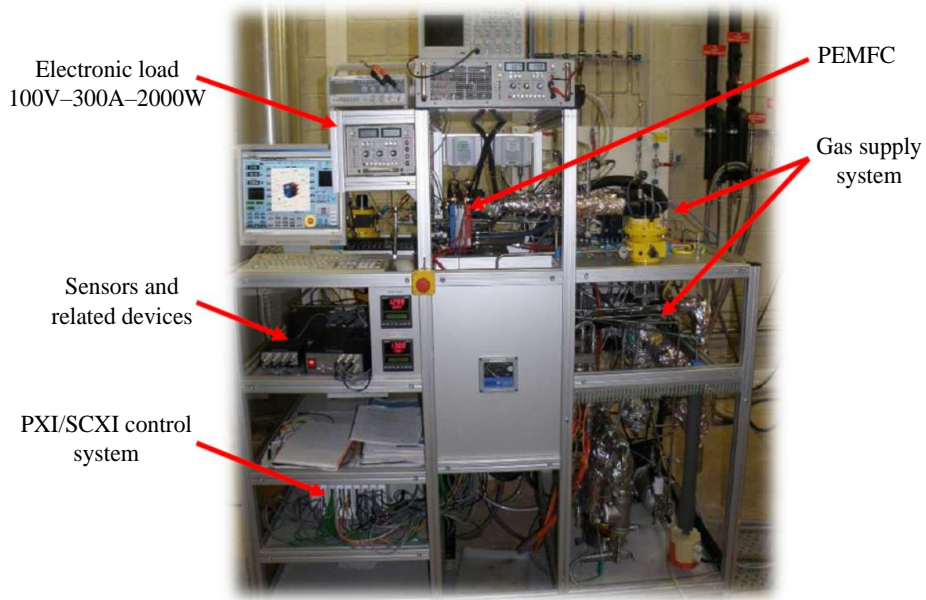

Figure 2: The durability test of PEMFC in power test platform of FCLAB

Table 2: The main parameter of PEMFC operated under the quasi-dynamic load current

Parameter	Value
Number of cells	5
Membrane thickness	25 μm
GDL thickness	415 μm
Active area	100 cm^2
PEMFC current	70 A with 7 A ripple
Relative humidity	52 %
Temperature	54 $^{\circ}C$
Hydrogen pressure	1.3 bar

Table 3: The main parameter of PEMFC operated under constant load current

Parameter	Value
Number of cells	5
Membrane thickness	25 μm
GDL thickness	415 μm
Active area	100 cm ²
PEMFC current	70 A
Relative humidity	50 %
Temperature	54 °C
Hydrogen pressure	1.3 bar

222 3. PEMFC prognosis method

223 3.1. Prognosis of PEMFC based on NARX

224 NARX combines the nonlinear mapping ability of the artificial neural
 225 network and the time series concept of the dynamic autoregressive model
 226 to solve the problem of time series prognosis [48]. NARX, which takes into
 227 account the historical state and exogenous input (operating conditions), is
 228 very suitable for the prognosis of PEMFC. The basic structure of NARX is
 229 shown in Figure 3.

230 As shown in Fig. 3, the NARX consists of an input layer, a hidden layer,
 231 and an output layer. X represents operating conditions that include load
 232 current, relative humidity, temperature, and hydrogen pressure. Y represents
 233 the output voltage of the PEMFC. $Y(t)$ is the historical state of PEMFC,
 234 $Y(t+1)$ is the prognosis state. d is the maximum delay, w is the weight, b is
 235 the threshold. f_1 and f_2 are activation functions of hidden layer and output
 236 layer, respectively.

237 The prognosis of PEMFC based on NARX is defined as the following
 238 equation.

$$Y(t+1) = f[Y(t), \dots, Y(t-d+1), X(t), \dots, X(t-d+1)] \quad (1)$$

239 The hidden layer output is obtained by equation 2.

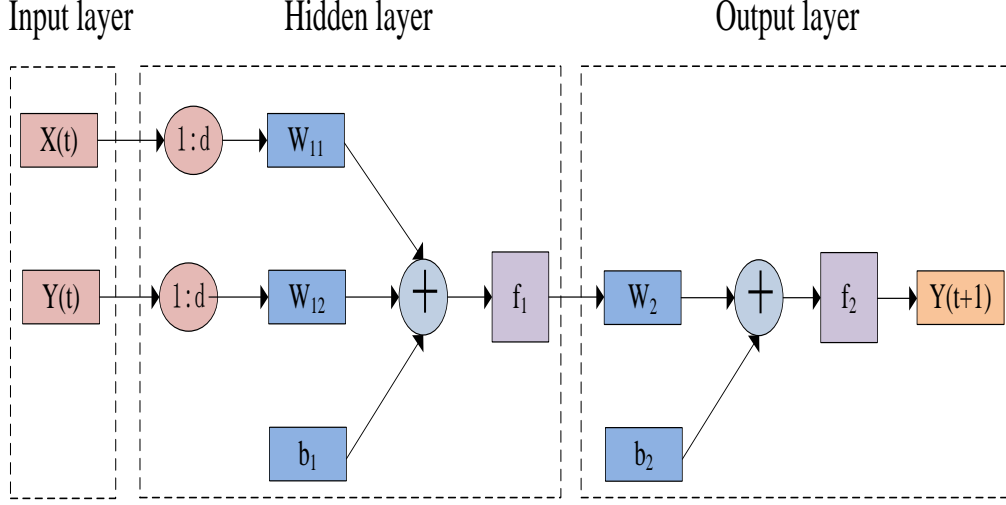

Figure 3: Basic structure of nonlinear autoregressive exogenous neural network

$$h_i = f_1\left[\sum_1^d W_{11}X(t) + \sum_1^d W_{12}Y(t) + b_1\right], i = 1, \dots, L \quad (2)$$

240 where h_i is the output of the i -th neuron in the hidden layer, and L is the
 241 number of neurons in the hidden layer.

242 The output layer output is obtained by equation 3.

$$o_j = f_2\left[\sum_1^L W_2h(i) + b_2\right], j = 1, \dots, m \quad (3)$$

243 where o_j is the output of the j -th neuron in the output layer, and m is the
 244 number of neurons in the output layer.

245 The biggest difference between the NARX and the general BP neural
 246 network is that state delay is added in the NARX. The historical state of
 247 PEMFC is considered by the state delay [49]. The parameters of weight and
 248 threshold for NARX are trained and adjusted in consideration of operating
 249 conditions and the historical state. Therefore, the NARX is considered to ap-
 250 ply in the prognosis of PEMFC that greatly affected by operating conditions
 251 and the historical state.

252 *3.2. Prognosis of PEMFC based on NARX and wavelet analysis*

253 Wavelet analysis decomposes time series signals through multi-resolution
 254 analysis. The multi-resolution analysis is the theoretical basis for signal
 255 decomposition and reconstruction under wavelet basis [50]. For any mea-
 256 surement signal, the multi-resolution analysis can decompose it into detail
 257 part and low frequency part, and then further decompose the low frequency
 258 part, which can be repeated to any scale. The decomposition process can be
 259 expressed by equation 4.

$$V = D1 \oplus A1 = D1 \oplus A2 \oplus A1 = \dots = D1 \oplus An \oplus \dots \oplus A1 \quad (4)$$

260 Based on the multi-resolution analysis theory, the Mallat algorithm of
 261 wavelet decomposition is proposed. The decomposition algorithm can be
 262 expressed as the following equation [50].

$$\begin{cases} a_0 = V \\ a_j = \sum_k h(t - 2k)a_{j-1} \\ d_j = \sum_k g(t - 2k)a_{j-1} \end{cases} \quad (5)$$

263 where the low frequency part/approximation part $Aj = [a_1, a_2, \dots, a_j]$ is
 264 called the j-th layer approximation coefficient, and the high frequency part/
 265 detail part $Dj = [d_1, d_2, \dots, d_j]$ is called the j-th layer detail coefficient. $H =$
 266 $\{h_j\}_{j \in Z}$ and $G = \{g_j\}_{j \in Z}$ are low-pass filter and high-pass filter respectively.

267 The signal decomposition process is shown in Figure 4. $A1$, $A2$, and $A3$
 268 are low frequency part, and $D1$, $D2$, and $D3$ are high frequency part.

269 The wavelet coefficients of each layer can be restored to the original se-
 270 quence length by single reconstruction [50]. The reconstruction algorithm of
 271 wavelet coefficients is expressed as follows:

$$a_{j-1} = \sum_k h(t - 2k)a_j + \sum_k g(t - 2k)d_j \quad (6)$$

272 Decompose the time series signal into multiple sub-waveforms, and then
 273 the prognosis of multiple sub-waveforms can greatly increase the accuracy of
 274 signal prediction. The raw voltage waveform of PEMFC is decomposed by
 275 wavelet analysis. The low frequency part reflects the overview of the volt-
 276 age degraded waveform (global degradation trend), and the high frequency
 277 part reflects the detail of the voltage degraded waveform (fluctuations and

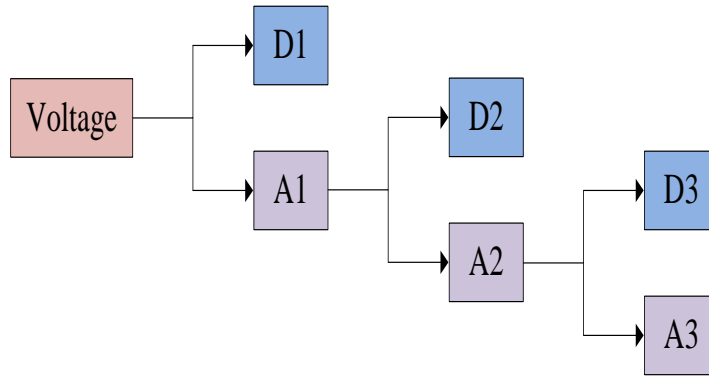

Figure 4: The voltage signal decomposition process based on wavelet basis

278 recovery phenomena of PEMFC). The prognosis of PEMFC using NARX
 279 and wavelet analysis is presented in Fig. 5.

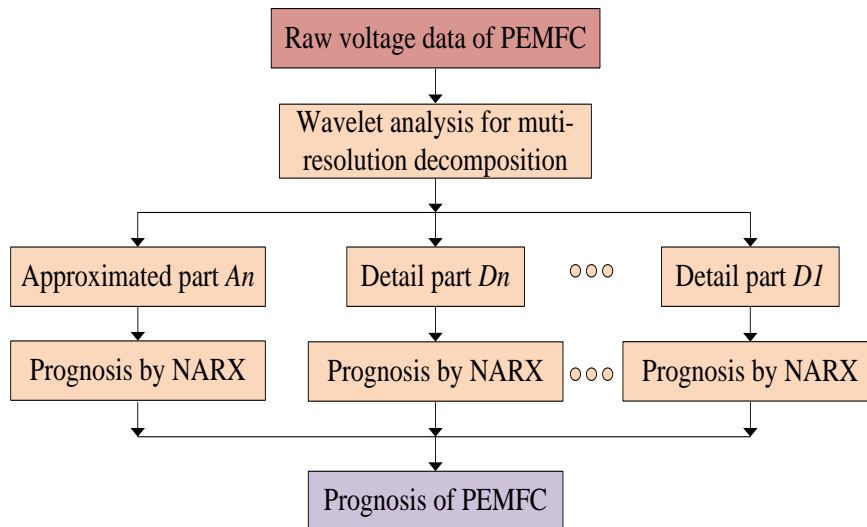

Figure 5: The degradation prognosis of PEMFC based on NARX and wavelet analysis

280 As shown in Fig. 5, the wavelet analysis is firstly adopted to decompose
 281 the raw voltage degraded waveform of PEMFC into multiple sub-waveforms.
 282 Then, the prognosis of each sub-waveform is made separately by NARX.
 283 Finally, the prognosis of W-NARX is obtained by adding the prognosis of
 284 each sub-waveform.

285 4. Results and validation

286 4.1. Setting of the prognosis method

287 For NARX, the historical status, load current, relative humidity, tem-
288 perature, and hydrogen pressure are selected as the input variables. The
289 output voltage of PEMFC is selected as the output variable. The number of
290 maximum delay is selected as 3. The number of neurons in the hidden layer
291 of NARX is chosen as 10. The activation function in hidden layer is set to
292 sigmoid, and the activation function in output layer is set to linear.

293 For wavelet analysis, the wavelet function type and decomposition scale
294 have a great influence on the prognosis of PEMFC. The order 6 Daubechies
295 wavelet is selected as the wavelet function. The decomposition scale is deter-
296 mined to ensure that the extracted voltage degradation signal is smooth [51].
297 Considering the accuracy and calculation amount, the number of decompo-
298 sition scale is selected as 3 for the prognosis of PEMFC in this paper.

299 In order to evaluate the calculation complexity of different methods, the
300 calculation time is adopted. The commercial computer with an i5-6300 Intel
301 CPU (2.3 GHz clock and 12GB RAM) is used to execute proposed methods.
302 In order to evaluate the accuracy of different methods, Absolute Error (AE),
303 Relative Error (RE), and Mean Square Error (MSE) are used in this paper.
304 Smaller values of AE, RE, and MSE means higher accuracy for the prognosis
305 of PEMFC.

306 4.2. The prognosis of PEMFC based on the W-NARX and different methods

307 In order to analyze the impact of wavelet analysis on degradation prog-
308 nosis, the prognosis of PEMFC in FCHEV operated under real conditions is
309 made by W-NARX and NARX. 70% of datasets for PEMFC in FCHEV are
310 applied to learn the degradation trend of PEMFC, and remained datasets
311 are applied to verify the prognosis of PEMFC in FCHEV. The sub-waveform
312 prognosis of PEMFC in FCHEV based on the W-NARX is shown in Fig.
313 6. The comparison of the prognosis of PEMFC based on the W-NARX and
314 NARX is shown in Fig. 7. The AE of the two methods is shown in Fig. 8.

315 As shown in Fig. 6, the degradation trend of each wavelet can be accu-
316 rately learned and forecasted by W-NARX for PEMFC in FCHEV. As shown
317 in Fig. 7, the prognosis of PEMFC based on the W-NARX is better than
318 that of NARX. It shows that W-NARX can accurately learn and forecast
319 PEMFC fluctuations and recovery phenomena. As shown in Fig. 8, the AE
320 of NARX is greater than the AE of W-NARX. The MSE of prognosis of

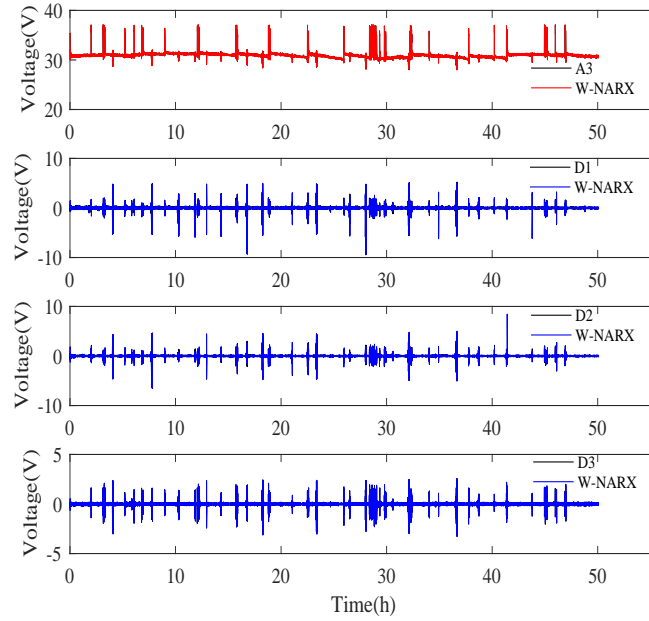

Figure 6: The sub-waveform prognosis of PEMFC in FCHEV under real conditions based on W-NARX

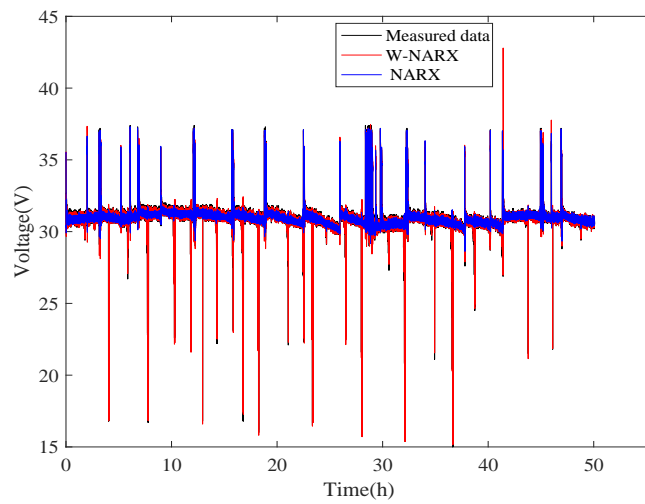

Figure 7: The degradation prognosis of PEMFC in FCHEV under real conditions based on W-NARX and NARX

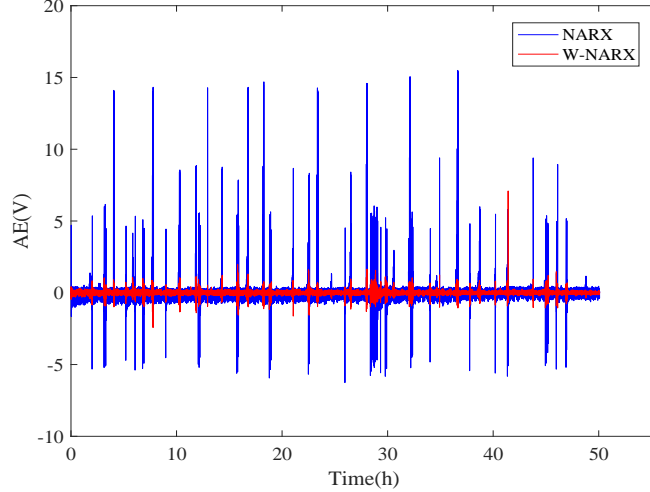

Figure 8: The AE for degradation prognosis of PEMFC in FCHEV under real conditions based on W-NARX and NARX

321 PEMFC based on the W-NARX is about 0.0059, and the MSE of prognosis
 322 of PEMFC based on the NARX is about 0.0923. The mean RE of prognosis
 323 of PEMFC based on the W-NARX is about 0.1359%, and the mean RE of
 324 prognosis of PEMFC based on the NARX is about 0.3277%. Compared with
 325 the W-NARX, the mean RE of NARX increases by 2.4 times. The reason
 326 why the error of W-NARX is lower than the error of NARX is that the fluc-
 327 tuations and recovery phenomena are decomposed into multiple wavelets by
 328 wavelet analysis to learn and forecast the degradation of PEMFC. The cal-
 329 culation time of W-NARX is about 918s, and that of NARX is about 232s.
 330 Wavelet analysis causes an increase in calculation time. However, compared
 331 with the degraded time of the PEMFC, the calculation time of W-NARX is
 332 very small. Therefore, W-NARX can be regarded as an appropriate prognosis
 333 method to deal with fluctuation and recovery phenomena for PEMFC.

334 In order to verify the advantages of the proposed method, the prognosis of
 335 PEMFC in FCHEV is also made by W-NARX, k-Nearest Neighbors (KNN)
 336 algorithm, Decision Tree (DT), and Support Vector Machine (SVM). The
 337 comparison of the prognosis of PEMFC based on different methods is shown
 338 in Fig. 9. The AE of the prognosis of PEMFC based on the different methods
 339 is shown in Fig. 10. The comparison of the accuracy and calculation time of
 340 the different methods is shown in Table 4.

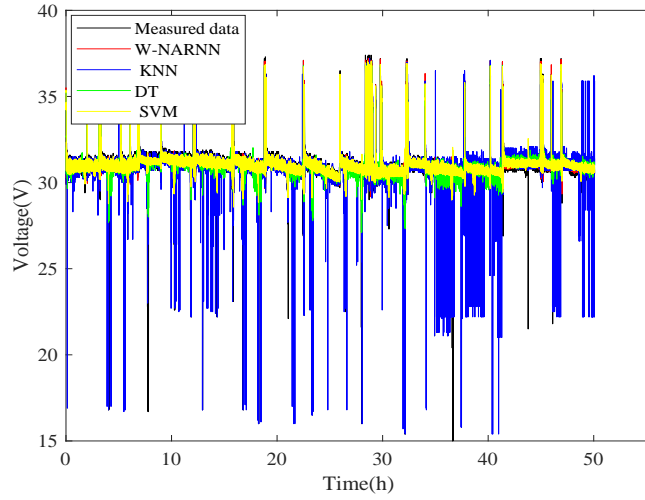

Figure 9: The degradation prognosis of PEMFC in FCHEV under real conditions using different methods

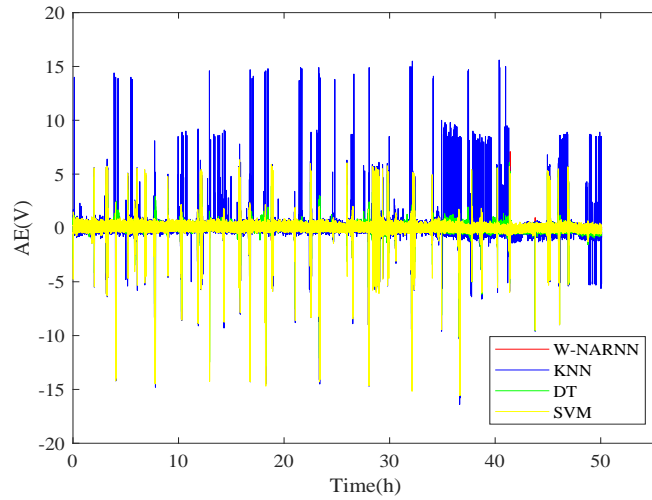

Figure 10: The AE for degradation prognosis of PEMFC in FCHEV under real conditions using different methods

Table 4: The comparison of the accuracy and calculation time of the different methods

Method	MSE	mean RE (%)	Time (s)
KNN	1.0749	1.3161	9
DT	0.1553	0.6587	39
SVM	0.1337	0.5049	1338
W-NARX	0.0059	0.1359	918

341 As shown in Fig. 9, compared with other methods, the prognosis of
 342 the proposed W-NARX is closest to the measured data of the PEMFC in
 343 FCHEV. As shown in Fig. 10, the AE of the prognosis of PEMFC based on
 344 the proposed W-NARX is the smallest. As shown in Table 4, the MSE and
 345 mean RE of the proposed W-NARX are the smallest compared with other
 346 methods. The proposed W-NARX has higher accuracy than KNN, DT, and
 347 SVM.

348 4.3. The effect of maximum delay on the prognosis of PEMFC

349 The maximum delay has a great influence on the prognosis of PEMFC.
 350 For example, the greater the maximum delay, the more historical information
 351 of PEMFC the NARX can remember, but it may also cause overfitting. In
 352 order to analyze the effect of maximum delay on the accuracy, the prognosis of
 353 PEMFC operated under a quasi-dynamic load current is made by W-NARX
 354 with different maximum delays. The maximum delay is set to 1, 2, 3, 4, 5,
 355 7, 10, and 15. In order to reduce measurement errors and calculations, the
 356 recorded data is resampled every hour. 70% of datasets for PEMFC operated
 357 under quasi-dynamic load current are applied to learn the degradation trend
 358 of PEMFC, and remained datasets are applied to verify the prognosis of
 359 PEMFC. The prognosis of PEMFC operated under a quasi-dynamic load
 360 current based on the W-NARX with different maximum delays are shown in
 361 Fig. 11. The AE of the W-NARX with different maximum delays are shown
 362 in Fig. 12. The MSE, mean RE, and calculation time of the W-NARX
 363 with different maximum delays are shown in Fig. 13, Fig. 14 and Fig. 15,
 364 respectively.

365 As shown in Fig. 11, the degradation trend of PEMFC operated under a
 366 quasi-dynamic load current can be accurately learned and forecasted by W-
 367 NARX with different maximum delays. As shown in Fig. 12, the maximum

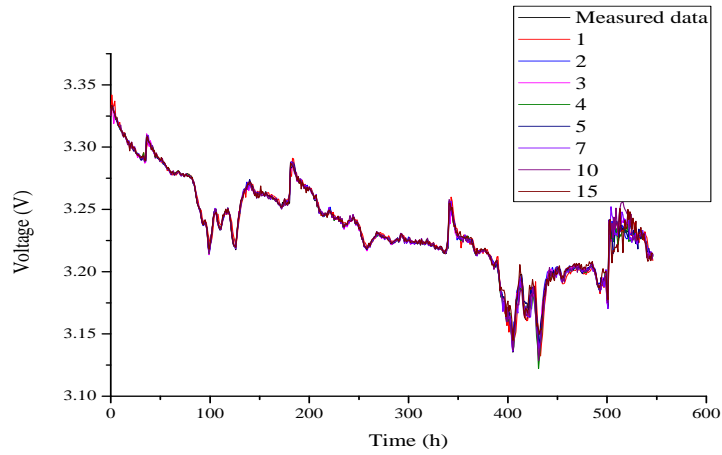

Figure 11: Degradation prognosis of PEMFC under quasi-dynamic load current based on W-NARX with different maximum delays

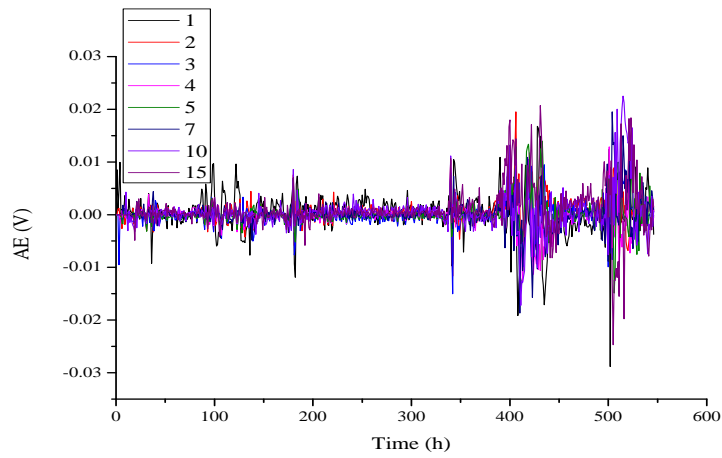

Figure 12: The AE for degradation prognosis of PEMFC under quasi-dynamic load current based on W-NARX with different maximum delays

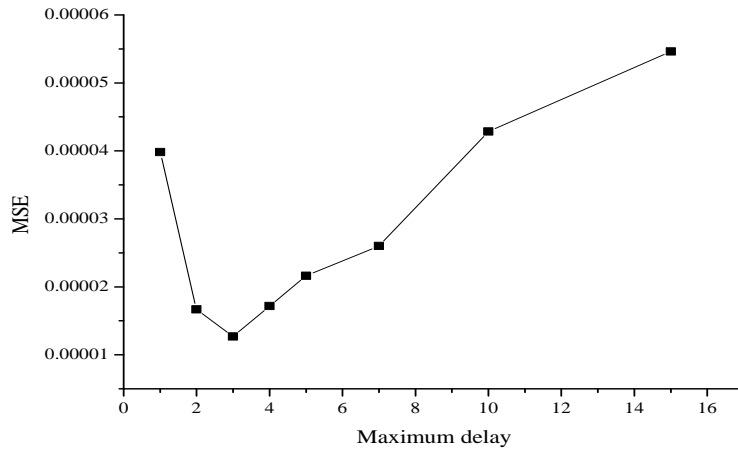

Figure 13: The MSE for degradation prognosis of PEMFC under quasi-dynamic load current based on W-NARX with different maximum delays

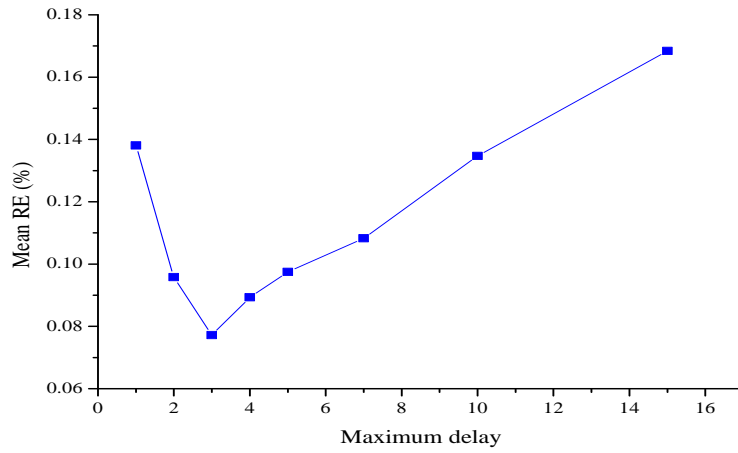

Figure 14: The mean RE for degradation prognosis of PEMFC under quasi-dynamic load current based on W-NARX with different maximum delays

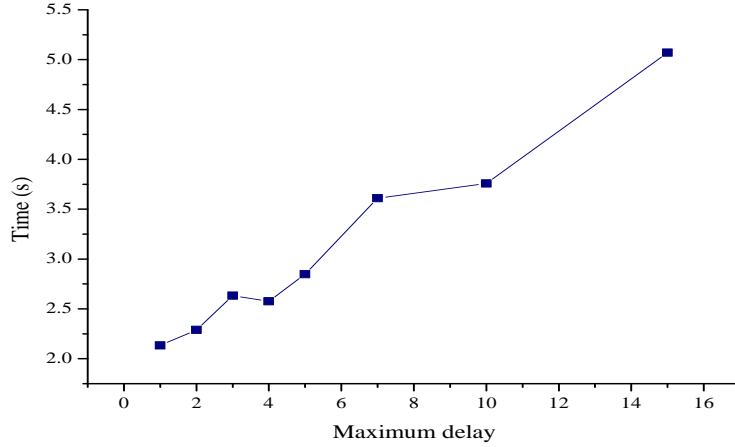

Figure 15: The calculation time for degradation prognosis of PEMFC under quasi-dynamic load current based on W-NARX with different maximum delays

368 AE of W-NARX with different maximum delays for the prognosis of PEMFC
 369 is less than 0.03V. As shown in Fig. 13 and Fig. 14, when the number
 370 of maximum delay is less than 3, the MSE and mean RE are large. Less
 371 maximum delay contains less degradation information of PEMFC, which
 372 causes an increase in the MSE and mean RE. When the number of maximum
 373 delay is more than 3, the MSE and mean RE are also large. Excessive
 374 maximum delay may lead to overfitting for the prognosis of PEMFC, which
 375 leads to an increase in the MSE and mean RE. As shown in Fig. 15, the
 376 calculation time increases as the number of maximum delay increases. This
 377 indicates that increasing the maximum delay will increase the amount of
 378 calculation. Considering the accuracy and amount of calculation, the number
 379 of the maximum delay is chosen as 3 for the prognosis of PEMFC in this
 380 paper.

381 4.4. The effect of learning data on the prognosis of PEMFC

382 The prognosis of PEMFC operated under constant load current is ana-
 383 lyzed by W-NARX with different learning data. In order to reduce measure-
 384 ment errors and calculations, the recorded data is resampled every hour. The
 385 learning data is respectively chosen as 40%, 50%, 60%, 70%, 80%, and 90%
 386 of datasets for PEMFC operated under constant load current, and remained
 387 datasets are applied to verify the prognosis of PEMFC. The prognosis of
 388 PEMFC operated under constant load current based on the W-NARX with

389 40% of datasets is shown in Fig. 16. The AE of the W-NARX with 40% of
 390 datasets is shown in Fig. 17. The MSE, mean RE, and calculation time of
 391 the W-NARX with different learning data are shown in Fig. 18, Fig. 19 and
 392 Fig. 20, respectively.

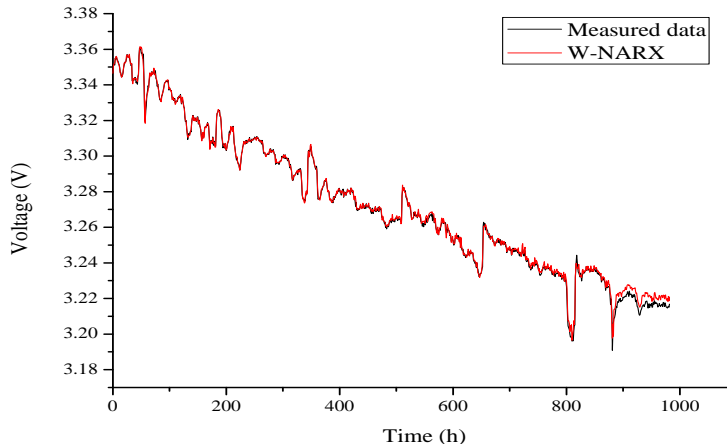

Figure 16: Degradation prognosis of PEMFC under constant load current based on W-NARX with 40% of datasets

393 As shown in Fig. 16, the degradation trend of PEMFC operated under
 394 constant load current can be accurately learned and forecasted by W-NARX
 395 with 40% of datasets. As shown in Fig. 17, the maximum AE of W-NARX
 396 with 40% of datasets for the prognosis of PEMFC is less than 0.01V. The
 397 MSE and mean RE of W-NARX with 40% of datasets for the prognosis of
 398 PEMFC are 0.000006 and 0.055%, respectively. It shows that W-NARX can
 399 accurately make the prognosis of PEMFC under the condition of less learning
 400 data. As shown in Fig. 18 and Fig. 19, the MSE and mean RE decreases
 401 as the learning data increases. As more recorded datasets are used to learn
 402 degradation trends of PEMFC, the prognosis of PEMFC based on W-NARX
 403 is more accurate, the MSE and mean RE are reduced. This indicates that
 404 more learning data can improve the accuracy of the degradation prognosis
 405 of PEMFC operated under constant load current. As shown in Fig. 20, the
 406 calculation time increases as the learning data increases. The reason for the
 407 increased calculation time is that more degradation trends of PEMFC need
 408 to be learned in more learning data.

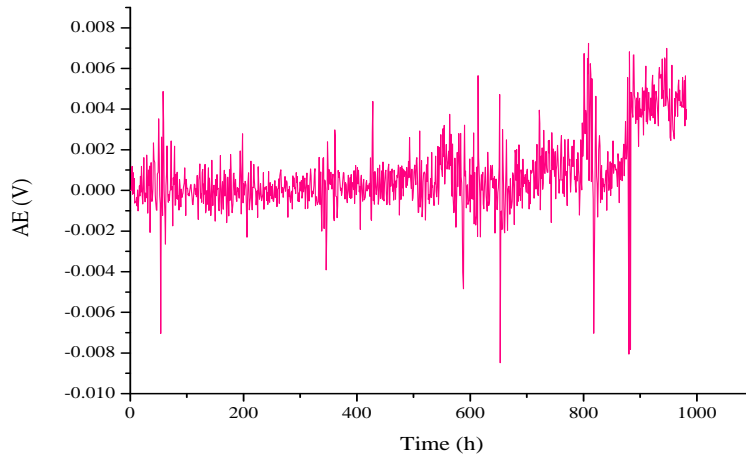

Figure 17: The AE for degradation prognosis of PEMFC under constant load current based on W-NARX with 40% of datasets

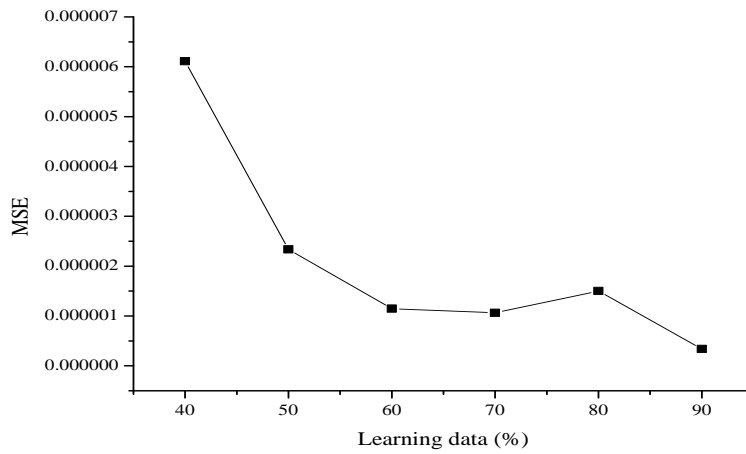

Figure 18: The MSE for degradation prognosis of PEMFC under constant load current based on W-NARX with different learning data

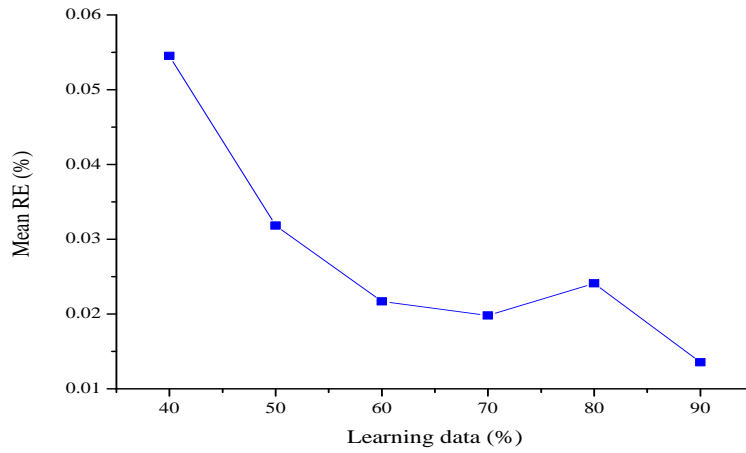

Figure 19: The mean RE for degradation prognosis of PEMFC under constant load current based on W-NARX with different learning data

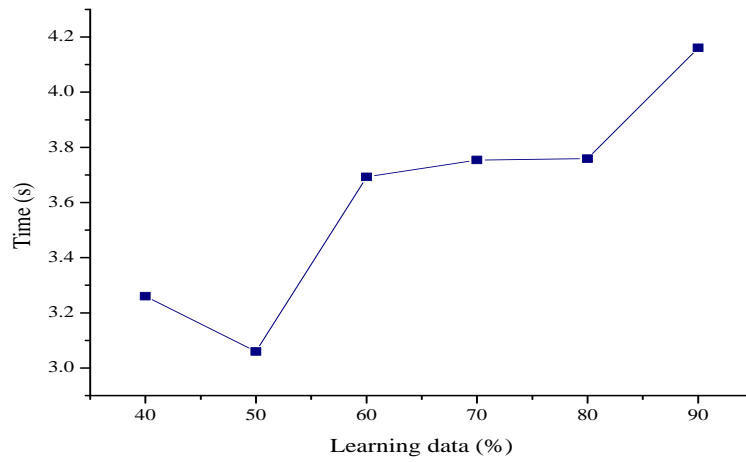

Figure 20: The calculation time for degradation prognosis of PEMFC under constant load current based on W-NARX with different learning data

409 5. Conclusions

410 As a kind of renewable and environmentally friendly energy, PEMFC is
411 regarded as a promising technology to solve the energy crisis and environ-
412 mental crisis. However, the durability caused by degradation seriously limits
413 its commercial application. Degradation prognosis, as the core of prognos-
414 tics and health management, is regarded as an important tool to improve
415 the durability of PEMFC. This paper presents the degradation prognosis of
416 PEMFC operated under different applications based on wavelet analysis and
417 NARX. The accuracy of the degradation prognosis of PEMFC is validated
418 by three durability tests of PEMFC operated under different applications.
419 The main conclusions of this paper are as follows:

- 420 1. Compared with the NARX, the accuracy of W-NARX increases by 2.4
421 times. The wavelet analysis greatly increases the accuracy of the degra-
422 dation prognosis of PEMFC based on NARX.
- 423 2. Compared with KNN, DT, and SVM, the proposed W-NARX has higher
424 accuracy for the degradation prognosis of PEMFC.
- 425 3. The MSE and mean RE are minimal when the maximum delay is 3. Con-
426 sidering the accuracy and amount of calculation, the number of the max-
427 imum delay is 3, which is best for the degradation prognosis of PEMFC.
- 428 4. The mean RE of W-NARX with 40% of datasets for the prognosis of
429 PEMFC is less than 0.06%. The W-NARX has a high accuracy of the
430 prognosis of PEMFC under the condition of less learning data. What is
431 more, more learning data helps to improve the accuracy of the degradation
432 prognosis of PEMFC.

433 The degradation of PEMFC has a great impact on the output perfor-
434 mance of PEMFC. The future research work will consider the presented
435 degradation prognosis method combining with energy management theory
436 to improve the output performance and economy for PEMFC in different
437 applications.

438 Acknowledgment

439 The support from Chinese Scholarship Council (CSC), Moby-Post project
440 funded under the Grant Agreement No.256834 by the European Unions sev-
441 enth Framework program (FP7/2007e2013) for the Fuel Cell and Hydrogen
442 Joint Technology Undertaking (<http://mobyproject.eu/>).

443 **References**

- 444 [1] Özçelep, Y., Sevgen, S., Samli, R.. A study on the hydrogen con-
445 sumption calculation of proton exchange membrane fuel cells for lin-
446 early increasing loads: Artificial Neural Networks vs Multiple Linear
447 Regression. *Renew Energy* 2020;156:570–578.
- 448 [2] Prodromidis, G.N., Coutelieris, F.A.. Solid Oxide Fuel Cell systems
449 for electricity generation: An optimization prospect. *Renew Energy*
450 2020;146:38–43.
- 451 [3] Herr, N., Nicod, J.M., Varnier, C., Jardin, L., Sorrentino, A., Hissel,
452 D., Péra, M.C.. Decision process to manage useful life of multi-stacks
453 fuel cell systems under service constraint. *Renew Energy* 2017;105:590–
454 600.
- 455 [4] Becherif, M., Hissel, D., Gaagat, S., Wack, M.. Electrical equiva-
456 lent model of a proton exchange membrane fuel cell with experimental
457 validation. *Renew Energy* 2011;36(10):2582–2588.
- 458 [5] Matraji, I., Laghrouche, S., Wack, M.. Cascade control of the moto-
459 compressor of a PEM fuel cell via second order sliding mode. In: 2011
460 50th IEEE Conf. Decis. Control Eur. Control Conf. 2011, p. 633–638.
- 461 [6] Laghrouche, S., Harmouche, M., Ahmed, F.S., Chitour, Y.. Control
462 of PEMFC air-feed system using Lyapunov-based robust and adaptive
463 higher order sliding mode control. *IEEE Trans Control Syst Technol*
464 2014;23(4):1594–1601.
- 465 [7] Boulon, L., Agbossou, K., Hissel, D., Sicard, P., Bouscayrol, A., Péra,
466 M.C.. A macroscopic PEM fuel cell model including water phenomena
467 for vehicle simulation. *Renew Energy* 2012;46:81–91.
- 468 [8] Mohammadi, M., Mehdipour-Ataei, S.. Durable sulfonated partially
469 fluorinated polysulfones as membrane for PEM fuel cell. *Renew Energy*
470 2020;158:421–430.
- 471 [9] Alipour MoghadamEsfahani, R., Vankova, S.K., Easton, E.B.,
472 Ebralidze, I.I., Specchia, S.. A hybrid Pt/NbO/CNTs catalyst with
473 high activity and durability for oxygen reduction reaction in PEMFC.
474 *Renewable Energy* 2020;154:913–924.

- 475 [10] Wang, H., Gaillard, A., Hissel, D.. A review of DC/DC converter-based
476 electrochemical impedance spectroscopy for fuel cell electric vehicles.
477 *Renew Energy* 2019;141:124–138.
- 478 [11] Yi, P., Li, X., Yao, L., Fan, F., Peng, L., Lai, X.. A lifetime
479 prediction model for coated metallic bipolar plates in proton exchange
480 membrane fuel cells. *Energy Convers Manag* 2019;183:65–72.
- 481 [12] Jouin, M., Bressel, M., Morando, S., Gouriveau, R., Hissel, D., Péra,
482 M.C., Zerhouni, N., Jemei, S., Hilairet, M., Ould Bouamama, B..
483 Estimating the end-of-life of PEM fuel cells: Guidelines and metrics.
484 *Appl Energy* 2016;177:87–97.
- 485 [13] Jouin, M., Gouriveau, R., Hissel, D., Péra, M.C., Zerhouni, N..
486 Prognostics and Health Management of PEMFC State of the art and
487 remaining challenges. *Int J Hydrogen Energy* 2013;38(35):15307–15317.
- 488 [14] Vichard, L., Petrone, R., Harel, F., Ravey, A., Venet, P., Hissel, D..
489 Long term durability test of open-cathode fuel cell system under actual
490 operating conditions. *Energy Convers Manag* 2020;212:112813.
- 491 [15] Sutharssan, T., Montalvao, D., Chen, Y.K., Wang, W.C., Pisac, C.,
492 Elemara, H.. A review on prognostics and health monitoring of proton
493 exchange membrane fuel cell. *Renew Sustain Energy Rev* 2017;75:440–
494 450.
- 495 [16] Jouin, M., Gouriveau, R., Hissel, D., Péra, M.C., Zerhouni, N..
496 Degradations analysis and aging modeling for health assessment and
497 prognostics of PEMFC. *Reliab Eng Syst Saf* 2016;148:78–95.
- 498 [17] Liu, H., Chen, J., Hissel, D., Lu, J., Hou, M., Shao, Z.. Prognostics
499 methods and degradation indexes of proton exchange membrane fuel
500 cells: A review. *Renew Sustain Energy Rev* 2020;123:109721.
- 501 [18] Bressel, M., Hilairet, M., Hissel, D., Ould Bouamama, B.. Extended
502 Kalman Filter for prognostic of Proton Exchange Membrane Fuel Cell.
503 *Appl Energy* 2016;164:220–227.
- 504 [19] Jouin, M., Gouriveau, R., Hissel, D., Péra, M.C., Zerhouni, N..
505 Prognostics of PEM fuel cell in a particle filtering framework. *Int J*
506 *Hydrogen Energy* 2014;39(1):481–494.

- 507 [20] Bressel, M., Hilairret, M., Hissel, D., Bouamama, B.O.. Remain-
508 ing useful life prediction and uncertainty quantification of proton ex-
509 change membrane fuel cell under variable load. *IEEE Trans Ind Electron*
510 2016;63(4):2569–2577.
- 511 [21] Chen, J., Zhou, D., Lyu, C., Lu, C.. A novel health indicator for
512 PEMFC state of health estimation and remaining useful life prediction.
513 *Int J Hydrogen Energy* 2017;42(31):20230–20238.
- 514 [22] Han, I.S., Park, S.K., Chung, C.B.. Modeling and operation opti-
515 mization of a proton exchange membrane fuel cell system for maximum
516 efficiency. *Energy Convers Manag* 2016;113:52–65.
- 517 [23] Wu, Y., Breaz, E., Gao, F., Paire, D., Miraoui, A.. Nonlin-
518 ear performance degradation prediction of proton exchange membrane
519 fuel cells using relevance vector machine. *IEEE Trans Energy Convers*
520 2016;31(4):1570–1582.
- 521 [24] Morando, S., Jemei, S., Hissel, D., Gouriveau, R., Zerhouni, N..
522 Proton exchange membrane fuel cell ageing forecasting algorithm based
523 on Echo State Network. *Int J Hydrogen Energy* 2017;42(2):1472–1480.
- 524 [25] Wang, F.K., Mamo, T., Cheng, X.B.. Bi-directional long short-
525 term memory recurrent neural network with attention for stack voltage
526 degradation from proton exchange membrane fuel cells. *J Power Sources*
527 2020;461:228170.
- 528 [26] Wu, Y., Breaz, E., Gao, F., Miraoui, A.. A modified relevance vector
529 machine for PEM fuel-cell stack aging prediction. *IEEE Trans Ind Appl*
530 2016;52(3):2573–2581.
- 531 [27] Silva, R., Gouriveau, R., Jemei, S., Hissel, D., Boulon, L., Agbossou,
532 K., Yousfi Steiner, N.. Proton exchange membrane fuel cell degradation
533 prediction based on Adaptive Neuro-Fuzzy Inference Systems. *Int J*
534 *Hydrogen Energy* 2014;39(21):11128–11144.
- 535 [28] Liu, J., Li, Q., Chen, W., Yan, Y., Qiu, Y., Cao, T.. Remaining useful
536 life prediction of PEMFC based on long short-term memory recurrent
537 neural networks. *Int J Hydrogen Energy* 2018;44(11):5470–5480.

- 538 [29] Cheng, Y., Zerhouni, N., Lu, C.. A hybrid remaining useful life prog-
539 nostic method for proton exchange membrane fuel cell. *Int J Hydrogen*
540 *Energy* 2018;43(27):12314–12327.
- 541 [30] Zhou, D., Al-Durra, A., Gao, F., Ravey, A., Matraji, I., Godoy
542 Simões, M.. Online energy management strategy of fuel cell hy-
543 brid electric vehicles based on data fusion approach. *J Power Sources*
544 2017;366(September 2018):278–291.
- 545 [31] Liu, H., Chen, J., Hissel, D., Su, H.. Remaining useful life estimation
546 for proton exchange membrane fuel cells using a hybrid method. *Appl*
547 *Energy* 2019;237:910–919.
- 548 [32] Duan, J., He, Y., Zhu, H., Qin, G., Wei, W.. Research progress
549 on performance of fuel cell system utilized in vehicle. *Int J Hydrogen*
550 *Energy* 2019;44(11):5530–5537.
- 551 [33] Park, J., Oh, H., Ha, T., Lee, Y.I., Min, K.. A review of the gas
552 diffusion layer in proton exchange membrane fuel cells: Durability and
553 degradation. *Appl Energy* 2015;155:866–880.
- 554 [34] Kannan, V., Xue, H., Raman, K.A., Chen, J., Fisher, A., Birgersson,
555 E.. Quantifying operating uncertainties of a PEMFC Monte Carlo-
556 machine learning based approach. *Renew Energy* 2020;158:343–359.
- 557 [35] Chen, H., Zhao, X., Zhang, T., Pei, P.. The reactant starvation of
558 the proton exchange membrane fuel cells for vehicular applications: A
559 review. *Energy Convers Manag* 2019;182:282–298.
- 560 [36] Mandal, P., Hong, B.K., Oh, J.G., Litster, S.. Understanding
561 the voltage reversal behavior of automotive fuel cells. *J Power Sources*
562 2018;397:397–404.
- 563 [37] Cao, T.F., Lin, H., Chen, L., He, Y.L., Tao, W.Q.. Numerical
564 investigation of the coupled water and thermal management in PEM
565 fuel cell. *Appl Energy* 2013;112:1115–1125.
- 566 [38] Hosseinzadeh, E., Rokni, M., Rabbani, A., Mortensen, H.H.. Thermal
567 and water management of low temperature Proton Exchange Membrane
568 Fuel Cell in fork-lift truck power system. *Appl Energy* 2013;104:434–444.

- 569 [39] Chen, K., Laghrouche, S., Djerdir, A.. Degradation prediction of
570 proton exchange membrane fuel cell based on grey neural network model
571 and particle swarm optimization. *Energy Convers Manag* 2019;195:810–
572 818.
- 573 [40] Hu, Z., Xu, L., Li, J., Ouyang, M., Song, Z., Huang, H.. A
574 reconstructed fuel cell life-prediction model for a fuel cell hybrid city
575 bus. *Energy Convers Manag* 2018;156:723–732.
- 576 [41] Gazdzick, P., Mitzel, J., Garcia Sanchez, D., Schulze, M., Friedrich,
577 K.A.. Evaluation of reversible and irreversible degradation rates of poly-
578 mer electrolyte membrane fuel cells tested in automotive conditions. *J*
579 *Power Sources* 2016;327:86–95.
- 580 [42] Jouin, M., Gouriveau, R., Hissel, D., Péra, M.C., Zerhouni, N..
581 Joint particle filters prognostics for proton exchange membrane fuel cell
582 power prediction at constant current solicitation. *IEEE Trans Reliab*
583 2016;65(1):336–349.
- 584 [43] Pei, P., Jia, X., Xu, H., Li, P., Wu, Z., Li, Y., Ren, P., Chen, D.,
585 Huang, S.. The recovery mechanism of proton exchange membrane fuel
586 cell in micro-current operation. *Appl Energy* 2018;226:1–9.
- 587 [44] Wang, F., Yang, D., Li, B., Zhang, H., Hao, C., Chang, F.,
588 Ma, J.. Investigation of the recoverable degradation of PEM fuel cell
589 operated under drive cycle and different humidities. *Int J Hydrogen*
590 *Energy* 2014;39(26):14441–14447.
- 591 [45] Chen, K., Laghrouche, S., Djerdir, A.. Fuel cell health prognosis using
592 Unscented Kalman Filter: Postal fuel cell electric vehicles case study.
593 *Int J Hydrogen Energy* 2019;44(3):1930–1939.
- 594 [46] Mohammadi, A., Djerdir, A., Steiner, N.Y., Bouquain, D., Khaburi,
595 D.. Diagnosis of PEMFC for automotive application. In: *IYCE 2015 -*
596 *Proc. 2015 5th Int. Youth Conf. Energy. IEEE. ISBN 1467371726; 2015,*
597 *p. 1–6.*
- 598 [47] Gouriveau, R., Hilairet, M., Hissel, D., Jemei, S., Jouin, M.,
599 Lechartier, E., Morando, S., Pahon, E., Pera, M.C., Zerhouni, N..
600 *IEEE PHM 2014 data challenge: Outline, experiments, scoring of re-*
601 *sults, winners. IEEE 2014 PHM Challenge, Tech Rep 2014;.*

- 602 [48] Menezes Jr, J.M.P., Barreto, G.A.. Long-term time series prediction
603 with the NARX network: An empirical evaluation. *Neurocomputing*
604 2008;71(16-18):3335–3343.
- 605 [49] Huo, F., Poo, A.N.. Nonlinear autoregressive network with exogenous
606 inputs based contour error reduction in CNC machines. *Int J Mach*
607 *Tools Manuf* 2013;67:45–52.
- 608 [50] Mallat, S.G.. Multifrequency channel decompositions of images and
609 wavelet models. *IEEE Transactions on Acoustics, Speech, and Signal*
610 *Processing* 1989;37(12):2091–2110.
- 611 [51] Misiti, M., Misiti, Y., Oppenheim, G., Poggi, J.M.. *Wavelets and*
612 *their Applications*. John Wiley & Sons; 2013. ISBN 1118613597.