



HAL
open science

Neuro-Second Order Sliding Mode Control of a DFIG based Wind Turbine System

Ibrahim Yaichi, Abdelhafid Semmah, P. Wira

► **To cite this version:**

Ibrahim Yaichi, Abdelhafid Semmah, P. Wira. Neuro-Second Order Sliding Mode Control of a DFIG based Wind Turbine System. *Journal of Electrical and Electronics Engineering*, 2020, 13 (1), pp.63-68. hal-03544851

HAL Id: hal-03544851

<https://hal.science/hal-03544851>

Submitted on 10 Mar 2022

HAL is a multi-disciplinary open access archive for the deposit and dissemination of scientific research documents, whether they are published or not. The documents may come from teaching and research institutions in France or abroad, or from public or private research centers.

L'archive ouverte pluridisciplinaire **HAL**, est destinée au dépôt et à la diffusion de documents scientifiques de niveau recherche, publiés ou non, émanant des établissements d'enseignement et de recherche français ou étrangers, des laboratoires publics ou privés.



Distributed under a Creative Commons Attribution - NonCommercial 4.0 International License

Neuro-Second Order Sliding Mode Control of a DFIG based Wind Turbine System

YAICHI Ibrahim^{1,2}, SEMMAH Abdelhafid², WIRA Patrice³

¹Ahmed Draya University, Department of Science Technology, Faculty of Science Technology,
National Street N° 6, 01000 Adrar, Algeria, ibrahimyaichi@gmail.com

²Djillali Liabes University, Department of Electrical Engineering, Faculty of Electrical Engineering,
University campus, P. O. B. 89, 022000 Sidi Bel Abbes, Algeria

³Université de Haute Alsace, Institut de Recherche en Informatique, Mathématiques, Automatique et Signal (IRIMAS),
61 Albert Camus Street, 68093 Mulhouse, France

Abstract – *In this paper, we propose a direct power control (DPC) using a second order sliding mode control (SOSMC) strategy and artificial neural network (ANN) for the doubly-fed induction generator (DFIG), which is applied to wind turbine system. The main objective of this intelligent technique is to replace the switching table and the hysteresis comparators with a NSOSMC control to reduce the ripple to the level of current and power. The best performances offered by the control technique proposed in the context of this work are verified by simulation using the Matlab / Simulink software. The proposed conventional direct power control (C-DPC) strategy produces a fast and robust power response. However, it suffers from the major problem which resides in the lack of control of the switching frequency which has a large variation which generates ripples at the level of the various quantities characterizing the DFIG. In this context and in order to overcome this problem, the C-DPC has been replaced by the intelligent NSOSMC control, which have a better response to variations in machine parameters.*

Keywords: *Wind Turbine System, Doubly Fed Induction Generator, MPPT, Conventional Direct Power Control, Second Order Sliding Mode Control, Artificial Neural Network.*

I. INTRODUCTION

Growing energy demands, dwindling sources of fossil fuels and concern about environmental pollution levels are the main motivations for producing electricity from renewable energy sources [1].

Renewable energies, such as solar, wind and motor tides are clean, inexhaustible and environmentally friendly energies. Because of all these factors, the generation of wind energy has attracted great interest in recent years [1].

The latest generation wind turbines operate at variable speed. This type of operation increases energy efficiency lowers mechanical loads and improves the quality of the electrical energy produced. Compared to fixed speed wind turbines, these are the control

algorithms that allow the active and reactive powers produced by the wind turbine to be controlled at all times [2].

Currently, the market for variable speed wind generators is geared towards powers greater than 1MW, in particular to make the most of the wind field at the site. These generators often use the Doubly Fed Induction Generator (DFIG) as a generator given its advantages [3].

The wind turbines used for the production of electricity must make it possible to produce a maximum of operating power at best the energy available in the wind. This is why many control systems of the wind turbine, acting on the mechanical or electrical part, are developed to maximize the energy conversion. We then speak of finding the maximum power point of operation (MPPT).

Direct power control (DPC) is based on the concept of direct torque control (DTC) applied to electric machines. The aim is to directly control the active and reactive powers in the converter on the machine side. The switching states of the converter are selected by the switching table; the latter is produced from instantaneous errors obtained from the difference between the value to estimate and measure of the active, reactive power [4].

Artificial Neural Network is a data processing technique that is well understood and well mastered. These techniques integrate perfectly into control strategies. In fact, they carry out identification, control or filtering functionalities, and extend the classic techniques of non-linear automation to arrive at more efficient and robust solutions.

The sliding mode control belongs to the family of controllers with variable structure, that is to say commands switching between several different control laws. In order to obtain higher performance, we have proposed a hybrid method which combines ANN and SOSMC which is called NSOSMC.

II. WIND TURBINE MODEL

The wind speed or wind power is defined as follows [4]:

$$P_v = \frac{1}{2} \rho S v^3 \quad (1)$$

In reality, the conversion device (the wind turbine) extracts aerodynamic power P_{aer} less than the available power P_v .

$$P_{aer} = C_p \cdot P_v = C_p(\beta, \lambda) \frac{1}{2} \rho S v^3 \quad (2)$$

The speed ratio is defined as the ratio between the linear speed of the blades and the wind speed:

$$\lambda = R \frac{\Omega_{turbine}}{v} \quad (3)$$

Where $\Omega_{turbine}$ is the speed of the turbine.

Knowing the speed of the turbine, so the aerodynamic torque directly determined by:

$$C_{aer} = \frac{P_{aer}}{\Omega_{turbine}} = C_p \frac{1}{2} \rho S v^3 \frac{1}{\Omega_{turbine}} \quad (4)$$

The power coefficient expression of a 1.5 MW wind turbine is approximated by equation [5], [6]:

$$C_p(\beta, \lambda) = (0.5 - 0.0167(\beta - 2)) \sin\left[\frac{\pi(\lambda + 0.1)}{18.5 - 0.3(\beta + 2)}\right] - 0.00184(\lambda - 3)(\beta - 2) \quad (5)$$

The proportional-integral regulator (PI) used to control the speed of rotation and to attenuate the effect of the torque of the DFIG considered as a disturbance. The block diagram of the MPPT control is illustrated in Fig. 1.

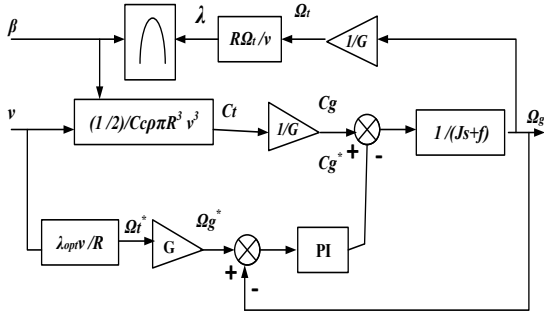

Fig. 1 MPPT control of DFIG

III. MODELING OF THE DFIG

In the synchronous d-q reference frame rotating at ω_s speed, the model of the DFIG is given by the following equations [7]:

Rotor and stator components:

$$\begin{cases} V_{ds} = R_s I_{ds} + \frac{d\Psi_{ds}}{dt} - \omega_s \Psi_{qs} \\ V_{qs} = R_s I_{qs} + \frac{d\Psi_{qs}}{dt} + \omega_s \Psi_{ds} \\ V_{dr} = R_r I_{dr} + \frac{d\Psi_{dr}}{dt} - (\omega_s - \omega_r) \Psi_{qr} \\ V_{qr} = R_r I_{qr} + \frac{d\Psi_{qr}}{dt} + (\omega_s - \omega_r) \Psi_{dr} \end{cases} \quad (6)$$

Rotor and stator flux components [8]:

$$\begin{cases} \Psi_{ds} = L_s I_{ds} + M I_{dr} \\ \Psi_{qs} = L_s I_{qs} + M I_{qr} \\ \Psi_{dr} = L_r I_{dr} + M I_{ds} \\ \Psi_{qr} = L_r I_{qr} + M I_{qs} \end{cases} \quad (7)$$

The electromagnetic torque is also expressed as a function of currents and flux by:

$$C_{em} = \frac{3}{2} \frac{M}{L_s} p (\Psi_{qs} I_{dr} - \Psi_{ds} I_{qr}) \quad (8)$$

Mechanical equation:

$$J \frac{d\Omega}{dt} = C_{em} - C_r - f\Omega \quad (9)$$

In the two-phase reference, the active and reactive stator powers of a DFIG are written according to:

$$\begin{cases} P_s = \frac{3}{2} (V_{ds} I_{ds} + V_{qs} I_{qs}) \\ Q_s = \frac{3}{2} (V_{qs} I_{ds} - V_{ds} I_{qs}) \end{cases} \quad (10)$$

IV. DIRECT POWER CONTROL OF THE DFIG

The study of literature is sometimes surprising. Generally, the systems evolve on bases which are at the origin very simple and which become complex with the time. The transition from vector control to direct torque and flux control (DTC) is marked by a major simplification of the control algorithm. Only, one could really wonder why the development of the direct control of the active and reactive powers (DPC) did not occur before the command DTC [9], [10].

The active and reactive powers are given by the following relations [11]:

$$\begin{cases} P_s = -\frac{3}{2} \frac{M}{\sigma L_s L_r} V_s \Psi_{r\beta} \\ Q_s = \frac{3}{2} \left(\frac{V_s}{\sigma L_s} \Psi_{r\alpha} - \frac{V_s M}{\sigma L_s L_r} \Psi_{r\alpha} \right) \end{cases} \quad (11)$$

Where:

$$\begin{cases} \Psi_{r\alpha} = \sigma L_r i_{r\alpha} + \frac{M}{L_s} \Psi_s \\ \Psi_{r\beta} = \sigma L_r i_{r\beta} \\ |\overline{\Psi}_s| = \frac{|\overline{V}_s|}{\omega_s} \\ \sigma = 1 - \frac{M^2}{L_s L_r} \end{cases} \quad (12)$$

If by introducing the angle δ between Ψ_s and Ψ_r , P_s and Q_s become [12]:

$$\begin{cases} P_s = -\frac{3}{2} \frac{M}{\sigma L_s L_r} \omega_s |\Psi_s| |\Psi_r| \sin \delta \\ Q_s = \frac{3}{2} \frac{\omega_s}{\sigma L_s} |\Psi_s| \left(\frac{M}{L_r} |\Psi_r| \cos \delta - |\Psi_s| \right) \end{cases} \quad (13)$$

The variation of two active and reactive powers is given by the following relation:

$$\begin{cases} \frac{dP_s}{dt} = -\frac{3}{2} \frac{M}{\sigma L_s L_r} \omega_s |\Psi_s| \frac{d(|\Psi_r| \sin \delta)}{dt} \\ \frac{dQ_s}{dt} = \frac{3}{2} \frac{M \omega_s}{\sigma L_s L_r} |\Psi_s| \frac{d(|\Psi_r| \cos \delta)}{dt} \end{cases} \quad (14)$$

V. NEURO-SECOND ORDER SLIDING MODE CONTROL

In order to improve the performance of DFIG in the context of wind power production, we will propose a hybrid method which combines ANN and SOSMC applicable when the requirements on the precision and other dynamic characteristics of the system are required, taking account of the nonlinearities of the model.

In the control of non-linear systems or systems with non-constant parameters, the classical control laws may

be insufficient because they are non-robust especially when the requirements on the precision and other dynamic characteristics of the systems are strict. We must use control laws that are insensitive to variations in parameters, disturbances and non-linearity [13].

The principle of control by sliding modes is to force the trajectories of the system to reach a given surface, sliding surface, and then stay there [14].

The SOSMC does not need precise mathematical models like conventional control. On the other hand, we choose the error between the powers of the reference (P_{s-ref} , Q_{s-ref}) stator and measured (P_s , Q_s) as surfaces in second order sliding mode control, so that we can write the following expression:

$$\begin{cases} S(P) = P_{s-ref} - P_s \\ S(Q) = Q_{s-ref} - Q_s \end{cases} \quad (15)$$

The derivative of the surface is:

$$\begin{cases} \dot{S}(P) = \dot{P}_{s-ref} - \dot{P}_s \\ \dot{S}(Q) = \dot{Q}_{s-ref} - \dot{Q}_s \end{cases} \quad (16)$$

We replace the expression of active and reactive power to obtain:

$$\begin{cases} \dot{S}(P) = -\frac{V_s M}{L_s L_r \sigma} V_{qr} + C_1 \\ \dot{S}(Q) = -\frac{V_s M}{L_s L_r \sigma} V_{dr} + C_2 \end{cases} \quad (17)$$

Such as:

$$\begin{cases} C_1 = \dot{P}_{s-ref} + \frac{V_s M}{L_s L_r \sigma} (R_r I_{qr} + g \omega_s \sigma L_r I_{dr} + g \frac{M V_s}{L_s}) \\ C_2 = \dot{Q}_{s-ref} + \frac{V_s M}{L_s L_r \sigma} (R_r I_{dr} - g \omega_s \sigma L_r I_{qr}) \end{cases} \quad (18)$$

The derivative of the equation (17) is:

$$\begin{cases} \dot{S}(P) = \frac{V_s M}{L_s L_r \sigma} \dot{V}_{qr} + C_1 \\ \dot{S}(Q) = \frac{V_s M}{L_s L_r \sigma} \dot{V}_{dr} + C_2 \end{cases} \quad (19)$$

The SOSMC controller of P_s and Q_s is used to affect the two rotor voltage components as in Eqs. (20) and (21).

$$\begin{cases} V_{dr} = K_1 |S(P)|^r \text{sign}(S(P)) + V_{dr1} \\ \dot{V}_{dr1} = K_2 \text{sign}(S(P)) \end{cases} \quad (20)$$

$$\begin{cases} V_{qr} = K_1 |S(Q)|^r \text{sign}(S(Q)) + V_{qr1} \\ \dot{V}_{qr1} = K_2 \text{sign}(S(Q)) \end{cases} \quad (21)$$

In order to ensure convergence in infinity of the time constants and are chosen to satisfy the following inequality [15]:

$$\begin{cases} K_1 > \frac{A_M}{B_m} \\ K_2 \geq \frac{4A_M B_m (K_1 + A_M)}{B_m^2 B_m (K_1 - A_M)} \end{cases} \quad (22)$$

Where

$$\begin{cases} A_M \geq |A| \\ K_M \geq K \geq K_m \end{cases} \quad (23)$$

The proposed SOSMC is designed to control the active and reactive powers illustrated in Fig. 2.

Neural networks are well known for their ability to learn and approximate any continuous function. They were applied to the identification of the parameters, the

estimation in the state space of the control systems of the reciprocating engines.

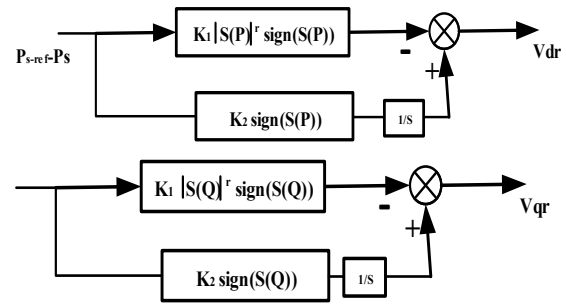

Fig. 2 Block diagram of SOSMC

ANN is not programmed; it is driven through a learning mechanism. Tasks particularly suited to neural network processing are: association, classification, discrimination, prediction or estimation, and control of complex processes [16], [17].

The Multi Layered Perceptron (MLP) is widely used in identification and control. With a hidden layer, it constitutes a "universal approximator" [18]. Recent research shows that it can result in approximating any input / output function provided that enough neurons are placed in the hidden layer and sigmoidal for the activation functions. Of course, the mathematical theorems do not show that a network with a single hidden layer is optimal [19].

One of the most common algorithms is back-propagation; this algorithm changes the weights of a network whose architecture is fixed by the operator, whenever an example $y_i = f(x_i)$ is presented. This change is done in such a way as to minimize the error between the desired output and the response of the network to an input x_i . This is achieved thanks to the gradient descent method [20], [21].

Among the back propagation techniques is the Levenberg-Marquardt algorithm. This latter algorithm will be used in our work for its speed of computation compared to the classic back-propagation algorithm.

The NSOSMC diagram of the proposed method is shown in Fig. 3.

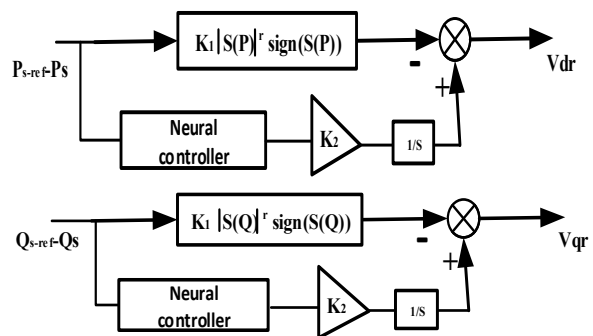

Fig. 3 Block diagram of NSOSMC

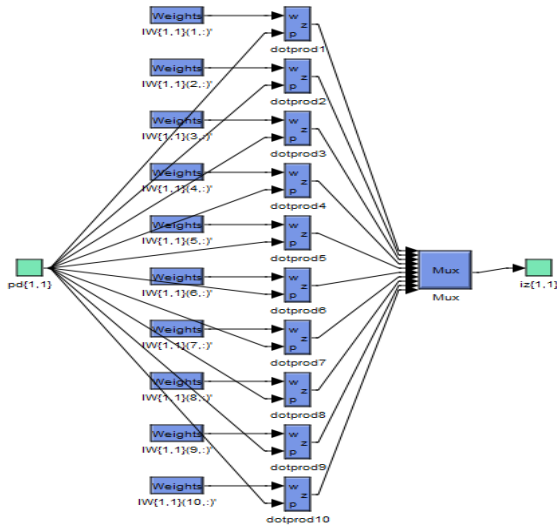

Fig. 4 Block diagram of the internal structure of hidden layer

The structure of the NSOSMC of the DFIG is shown in Fig. 5.

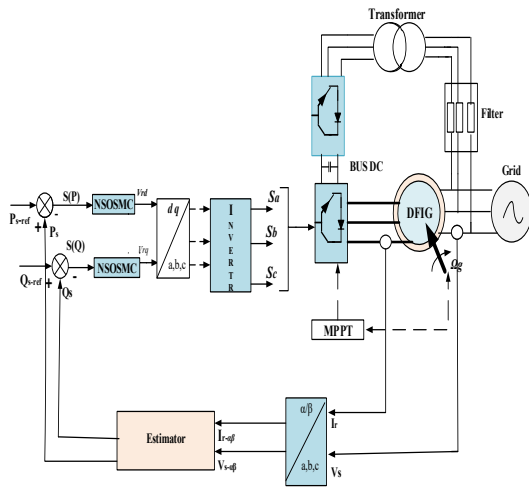

Fig. 5 Schematic diagram of the NSOSMC applied to DFIG

VI. SIMULATION RESULTS

To demonstrate the effectiveness of the proposed NSOSMC strategy, a comparative study between C-DPC and the NSOSMC control.

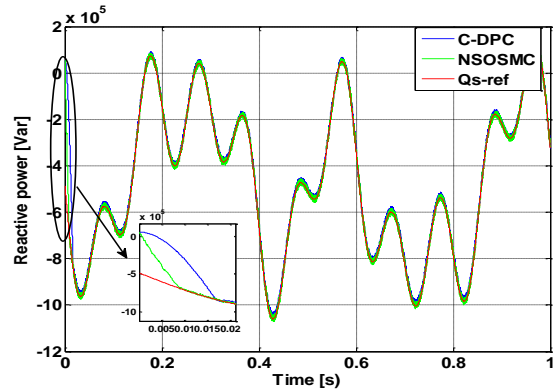
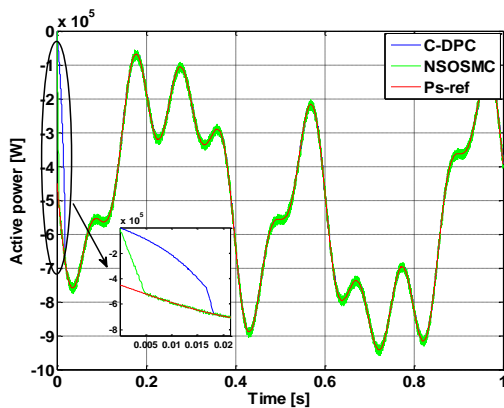

Fig. 6 Active and reactive power [C-DPC, NSOSMC] (reference tracking test)

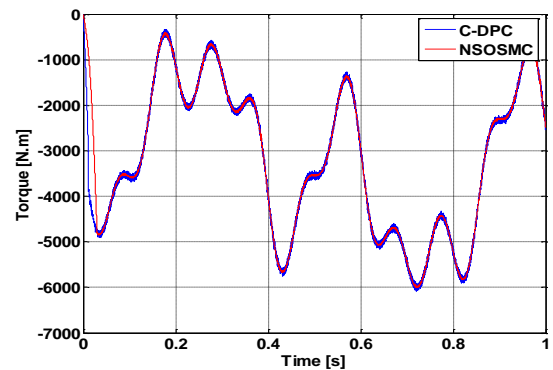

Fig. 7 Torque (reference tracking test)

According to the simulation results shown in Fig. 6 and Fig. 7, the NSOSMC method gives the best response time as well as the best precision with a complete elimination of the chattering phenomenon; the NSOSMC reaches its reference quickly, without exceeding the set point with respect to the C-DPC.

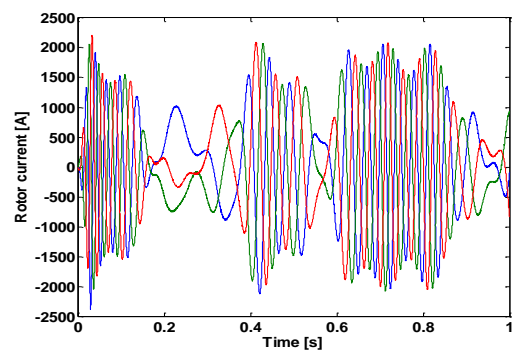
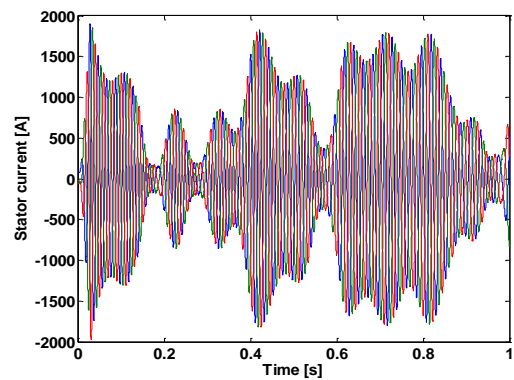

Fig. 8 Stator and rotor current [C-DPC]

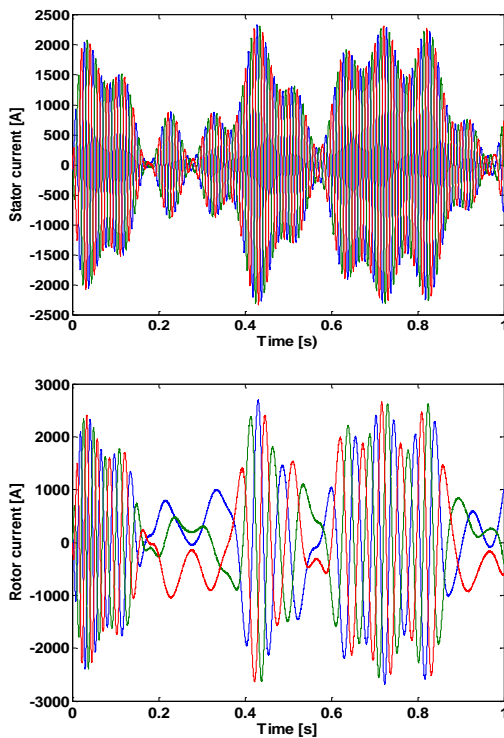

Fig. 9 Stator and rotor current [NSOSMC]

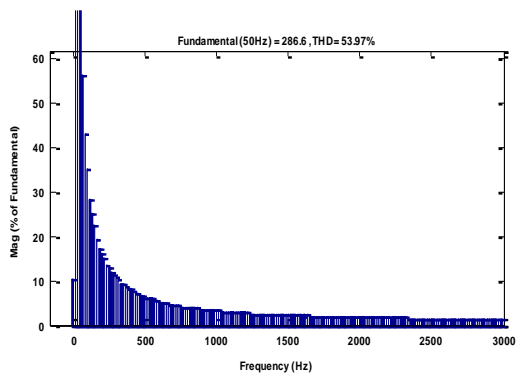

Fig. 10 Spectrum harmonic of a one-phase rotor current [C-DPC]

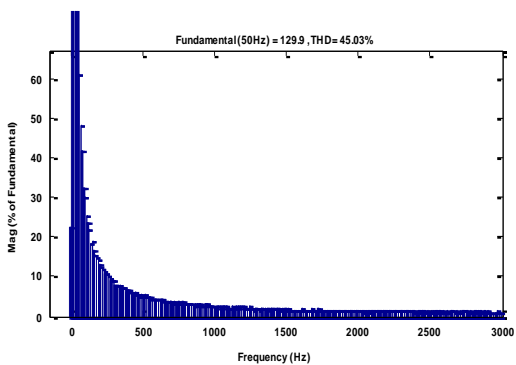

Fig. 11 Spectrum harmonic of a one-phase rotor current [NSOSMC]

Fig. 10 and Fig. 11 show the results obtained from the spectral analysis of the currents of the NSOSMC strategy, namely the rotor current. These results show that the NSOSMC guarantees a better quality of the

waveform of the stator current, whose harmonic distortion rate (THD) goes from 53.97% for the C-DPC to 45.03% for the NSOSMC.

VII. ROBUSTNESS TEST

To test the impact of parameter variations on the performance of each strategy, we decrease the mutual inductance M by 10% (case of saturation of the inductances) and we increase the rotor resistance R_r by 100% (case of warming-up of rotor windings). Fig. 12 shows the results of the simulation.

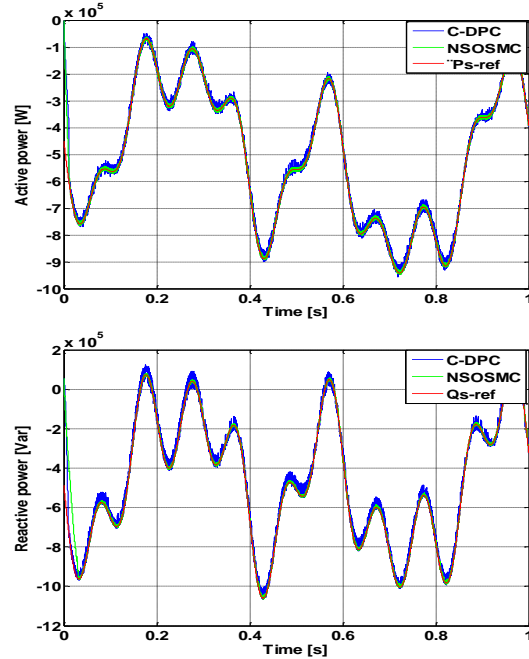

Fig. 12 Active and reactive power [C-DPC, NSOSMC] (robustness test)

The results of the robustness tests of Fig. 12 show that the NSOSMC is more robust than the C-DPC control in the presence of parametric variations of the DFIG.

These results allow us to conclude that the NSOSMC control is the most efficient in reducing the ripple of active and reactive powers compared to the conventional C-DPC control.

TABLE 1. Comparison of the performances of the three regulators

Performances	C-DPC	NSOSMC
Response time P_s (ms)	18	5
Response time Q_s (ms)	17	9
Robustness vis-a-vis variation parametric	Strong	More strong
THD (%) (robustness test)	53.97	45.03

Table 1 summarizes an overall comparison between C-DPC and NSOSMC, regarding the THD. The proposed wind energy system with NSOSMC achieved the best performance.

VIII. CONCLUSIONS

In order to control the active and reactive powers between the DFIG generator and the electricity grid used in a wind turbine system, an NSOSMC control is proposed. The results of simulations have shown that the application of a NSOSMC control gives a good response of active and reactive power. Power level ripples are lower compared to conventional a C-DPC technique, which is reflected in the quality of the currents generated by the DFIG.

From the comparative study between the proposed controller and the conventional C-DPC controller, it has been shown that the proposed NSOSMC is very effective on the stabilization of the system. Therefore the proposed method can contribute to expand wind energy utilization.

ANNEXES

TABLE 2. Doubly fed induction generator parameters

Rated power, P_n	1.5 MW
Rated current, I_n	1900 A
Rated DC-Link voltage U_{DC}	1200
Stator rated voltage, V_s	398/690 V
Stator rated frequency, f	50 Hz
Rotor inductance, L_r	0.0136
Stator inductance, L_s	0.0137
Mutual inductance, M	0.0135
Rotor resistance, R_r	0.021
Stator resistance, R_s	0.012
Number of pair of poles, p	2

TABLE 3. Wind turbine parameters

Number of blades	3
The power coefficient, $C_p \max$	0.59
Rotor radius, R	35.25 m
Speed multiplier gain, G	90
The density of the air, ρ	1.225 kg/m ³
Moment of total inertia, J	1000 Kg.m ²
Viscous friction coefficient, f_r	0.0024N.m..s ⁻¹

REFERENCES

- [1] Rapport, "Le Baromètre Eolien; Systèmes Solaires, Journal des Energies Renouvelables", N°183, Union Européen, Février 2008.
- [2] H. Camblong, "Minimisation de l'Impact des Perturbations d'Origine Eolienne dans la Génération d'Electricité par des Aérogénérateurs à Vitesse Variable"; Thèse de Doctorat, ENSAM, Bordeaux, France, 2003.
- [3] H. Abouobaida, M. Cherkaoui, "Modeling and Control of Doubly Fed Induction (DFIG) Wind energy conversion system", Journal of Electrical Engineering, Volume 15 / 2015 - Edition: 1, Article 15.1.24, 2015
- [4] H. Nian, Y. Song, P. Zhou, and Y. He, "Improved direct power control of a wind turbine driven doubly fed induction generator during transient grid voltage unbalance" IEEE Trans. Energy Convers., vol. 26, no. 3, pp. 976–986, 2011.
- [5] I. Yaichi, A. Semmah, M. Djilala, A. Harrouz, S. Mansouri, Y. Bakou, "Modelling and control of Doubly Fed Induction Machine, Application for a Wind Turbine System", IEEE Xplore Digital Library, International Renewable and Sustainable Energy Conference (IRSEC), Marrakech, Morocco, 2016.
- [6] B.Chitti Babu and K.B. Mohanty, "Doubly-Fed Induction Generator for Variable Speed Wind Energy Conversion Systems- Modeling & Simulation", International Journal of Computer and Electrical Engineering, 2010, pp. 141-147.
- [7] Saihi, L., Berbaoui, B., Glaoui, H., Djilali, L., Abdeldjalil, S. "Robust Sliding Mode H_∞ Controller of DFIG Based on Variable Speed Wind Energy Conversion System", Periodica Polytechnica Electrical Engineering and Computer Science, 64(1), pp. 53–63, 2020.
- [8] A. Tapia, G. Tapia, "Modeling and control of a wind turbine driven doubly fed induction generator" IEEE Transactions on Energy Conversion, vol. 18, no. 2, pp. 194–204, 2003.
- [9] H. Benbouhenni, Z. Boudjema, A. Belaidi, "Indirect vector control of a DFIG supplied by a two-level FSVI inverter for wind turbine system", Majlesi Journal of Electrical Engineering, Vol. 13, No. 1, 2019.
- [10] M. Malinowski, M. Jasinski, and M. P. Kazmierkowski, "Simple Direct power control of three phase PWM rectifier using space vector modulation (DPC-SVM)", IEEE Trans. on Industrial Electronics, vol. 51, no. 2, pp. 447-454, 2004.
- [11] Sung-Tak Jou, Sol-Bin Lee, Yong-Bae Park and Kyo-Beum Lee. "Direct Power Control of a DFIG in Wind Turbines to Improve Dynamic Responses", Journal of Power Electronics, 9, pp. 782-790, 2009.
- [12] Lie Xu, and P. Cartwright, "Direct Active and Reactive Power Control of DFIG For Wind Energy Generation", IEEE Transactions On Energy Conversion, Vol. 21, No. 3, pp.750-758, 2006.
- [13] Shang L. and Hu J., "Sliding mod based direct power control of grid connected wind turbine driven doubly fed induction generators under unbalanced grid voltage conditions", IEEE Transactions on Energy Conversion. Vol. 27, No. 2, pp. 362-373, 2012.
- [14] Jamoussi K., Chrifi A.L., Benderradi H., El Hajjaji A. and Ouali M., "Robust sliding mode control using adaptive switching gain for induction motors", International Journal of Automation and Computing, Vol. 10, No. 04, pp. 697-706, 2013.
- [15] D. Kim, K. Koo, J. J. Jeong, T. Goh and S. W. Kim, "Second-order discrete-time sliding mode observer for state of charge determination based on a dynamic resistance Li-Ion battery model" Energies, Vol. 6, pp. 5538–5551, 2013.
- [16] R. Kumar, R. A. Gupta, S.V. Bhangale, and H. Gothwal. "Artificial neural network based direct torque control of induction motor drives", IETECH Journal of Electrical Analysis, Vol. 2, pp. 159-165, 2008.
- [17] Rajesh Kumar, R.A. Gupta, S.V. Bhangale, Himanshu Gothwal, "Artificial Neural Network Based Direct Torque Control of Induction Motor Drives", IET-UK International Conference on Information and Communication.
- [18] M. Parizeau, "Réseaux Neurones", GIF-21140 et GIF-64326, 2004.
- [19] H. Mesai Ahmed, Y. Djeriri, A. Bentaallah, "Robust power control of DFIG using artificial neural networks for a wind energy conversion system based energy storage unit", 2nd International Symposium on Mechatronics & Renewable Energy ISMRE'2018.
- [20] P. Bourret, "Réseaux neuronaux : une Approche Connexionniste de l'IA" Edition TEKNA, TOULOUSE, France, 1991.
- [21] B. Widrow, M. A. Lehr, "30 years of adaptive neural networks: Perceptron, Adaline, and Back-propagation", Proceedings of the IEEE, Vol. 78, No. 9, pp.1415-1442.