



**HAL**  
open science

# Ion Channel Degeneracy, Variability, and Covariation in Neuron and Circuit Resilience

Jean-Marc Goillard, Eve Marder

► **To cite this version:**

Jean-Marc Goillard, Eve Marder. Ion Channel Degeneracy, Variability, and Covariation in Neuron and Circuit Resilience. 2022. hal-03544112

**HAL Id: hal-03544112**

**<https://hal.science/hal-03544112>**

Preprint submitted on 15 Mar 2022

**HAL** is a multi-disciplinary open access archive for the deposit and dissemination of scientific research documents, whether they are published or not. The documents may come from teaching and research institutions in France or abroad, or from public or private research centers.

L'archive ouverte pluridisciplinaire **HAL**, est destinée au dépôt et à la diffusion de documents scientifiques de niveau recherche, publiés ou non, émanant des établissements d'enseignement et de recherche français ou étrangers, des laboratoires publics ou privés.

September 28, 2020

## **Ion channel degeneracy, variability and covariation in neuron and circuit resilience**

**Jean-Marc Goillard**

[jean-marc.goillard@univ-amu.fr](mailto:jean-marc.goillard@univ-amu.fr) <http://orcid.org/0000-0001-8322-5632>

UMR\_S 1072, Aix Marseille Université, INSERM,  
Faculté de Médecine Secteur Nord,  
13015 Marseille, France

**Eve Marder**

[marder@brandeis.edu](mailto:marder@brandeis.edu) <http://orcid.org/0000-0001-9632-5448>

Volen Center and Biology Department, MS 013  
Brandeis University, Waltham, MA 02454, USA

Keywords: intrinsic excitability; potassium channels; calcium channels; conductance-based models; robustness; homeostasis

JMG acknowledges the support of ERC consolidator grant « CanaloHmics » (616827).

EM acknowledges the support of NIH grants R35 NS 097343, R01 MH46742 and the Steven J. Cloobek Research Fund

September 28, 2020

## Abstract

The large numbers of ion channels found in all nervous systems poses fundamental questions concerning how the characteristic intrinsic properties of single neurons are determined by the specific subsets of channels they express. All neurons display many different ion channels with overlapping voltage and time-dependent properties. We speculate that these overlapping properties promote resilience in neuronal function. Individual neurons of the same cell type show variability in ion channel conductance densities although they can generate reliable and similar behavior. This complicates a simple assignment of function to any conductance, and is associated with variable responses of neurons of the same cell type to perturbations, deletions, and pharmacological manipulation. Ion channel genes often show strong positively correlated expression, which may result from the molecular and developmental rules that determine which ion channels are expressed in a given cell type.

## **The Problem**

One of the challenges in neuroscience is to account for the behavior of a system, whether it be a neuron, a circuit, or a behavior, in terms of its underlying components, or processes. For example, the early biophysicists attempted to answer questions like, “How does the transient outward current,  $I_A$ , alter the dynamics of the neuron?” (Connor & Stevens 1971). The palpable successes of much of this early work led to an implicit (and often explicit) assumption that there should be a one-to-one map between the properties of a single kind of ion channel and its function.

We know today that animals have hundreds of ion channel genes (Jegla et al 2009, Littleton & Ganetzky 2000, Lovell et al 2013), including more than 140 voltage-gated ion channels (Yu et al 2005). Many individual neurons express 15-30 different kinds of voltage-gated ion channels (Cembrowski et al 2016, Fuzik et al 2016, Northcutt et al 2016, Northcutt & Schulz 2019, Ren et al 2019, Tapia et al 2018, Zheng et al 2019), including multiple potassium or calcium channels. Moreover, the same genes and channels are found in different combinations in various cell types. The theoretical number of possible combinations of voltage-gated ion channels (assuming only 15 kinds, expressed by one neuronal type, chosen among 140) is  $>10^{19}$ , by far exceeding the number of neurons in the human brain. Thus, it is clear that the developmental decisions made in the selection of which subset of channels a given neuron will express consists of a selection of a specific subset of channels, that together will give the neuron its characteristic electrophysiological signature. Therefore, the coordinate expression of subsets of channels becomes critical in understanding neuronal dynamics. Today, the job of querying the role(s) of a given ion channel in the dynamics of neurons has

changed, as the dynamics of neuronal activity always depends on the interaction among the entire set of conductances expressed by the neuron (Alonso & Marder 2019, Gunay et al 2008, Migliore et al 2018, Rathour & Narayanan 2014, Taylor et al 2009).

Complicating matters, a given pattern of activity can arise from many sets of conductance densities (Achard & De Schutter 2006, Alonso & Marder 2019, Prinz et al 2004). In principle, typical spiking neurons in different parts of the brain may produce activity that appears similar with different constellations of channels. So, accounting for neuronal and circuit dynamics on the basis of the ion channels expressed in those neurons and circuits requires a combination of molecular, electrophysiological, pharmacological, and computational methods.

### **Redundancy, Degeneracy, Functional Overlap**

Strictly speaking, the term “redundancy” assumes another equivalent copy of the same entity or mechanism (**Figure 1a**) (Edelman & Gally 2001). For example, airplanes have redundant components, two copies so that if one fails, the second is at the ready to maintain function. By that definition, two identical copies of a gene might be redundant, assuming that there is no appreciable dosage compensation. In contrast, most biological processes that are often termed redundant are examples of another enzyme, pathway, channel, etc compensating for a lost or missing function.

Edelman and Gally (2001) argued that the term “degeneracy” better captures two different solutions that give rise to the same output (**Figure 1a**). Consequently, some have adopted this term to refer to multiple solutions that can give rise to similar or nearly identical behavior (Alonso & Marder 2019, Prinz et al 2004). There is however, a fundamental difference between the degeneracy of the genetic code, in which two

different triplets encode the same amino acid (Nirenberg et al 1965), and that in other kinds of multiple solutions. In the former, the code is degenerate, but the ensuing amino acid is the same. In the latter, although under many sets of conditions the two outputs may appear quantitatively and qualitatively similar, when adequately perturbed, they will reveal the consequences of these differences (Alonso & Marder 2019, Alonso & Marder 2020). Indeed, it is now clear that much of what has been termed either redundant or degenerate in understanding channel function in cell dynamics is really “functional overlap” (**Figure 1**).

Functional overlap implies that the same function is carried by several pleiotropic (or pluri-functional) components that share a part of their functional repertoire. For example, a number of potassium currents can and do contribute to spike repolarization, and the relative contribution of these will depend on voltage and the previous history of activity of the neuron (Alonso & Marder 2020, Golowasch et al 1992, Ma & Koester 1996). This occurs because although each of the currents has different voltage and time-dependent properties, they are sufficiently overlapping in function that they can substitute for each other (**Figure 1b**). This is an important feature of biological systems that need to be robust and resilient against perturbation, as smooth transitions between the contributions of different channels can expand the dynamic range of a neuron or circuit (Alonso & Marder 2020).

### **Adequately defining outputs and cell identity**

To ask what role(s) a conductance or a synapse has on neuronal or circuit performance, it is necessary to reliably measure the output of that neuron or group of

neurons. In other words, to determine whether a change is a minor effect, well within the normal behavior of those cells or circuits, or whether a change has substantially altered the neuron's or circuit's behavior, it is necessary to know the normal function of those neurons and circuits. Today that is still more easily said than done in most large brain circuits.

Consequently, it remains profitable to examine small rhythmic or sensory circuits in invertebrates, because in these cases, it is often much clearer what the circuit does, what its natural range of outputs is, and therefore, whether a manipulation has appreciably altered the output. Indeed, many fundamental insights that have come from arthropods, molluscs, nematodes, and annelids, were feasible precisely because it is there possible to a) uniquely and unambiguously identify neurons, b) precisely determine anatomical projections and map connectivity, and c) study the biophysics of channels and the intrinsic properties of cells in the same neuron from preparation to preparation (Calabrese et al 2011, Cropper et al 2016, Lizbinski et al 2018, Marder 2012, Marder & Bucher 2007, Marder & Goaillard 2006). This tradition continues in the genetically tractable flies and worms, taking advantage of many tools to manipulate neurons during behavior (Bargmann 2012, Beverly et al 2011, Griffith 2012, Kang et al 2010, Sengupta & Garrity 2013).

An explosion of studies using RNAseq and other molecular techniques to identify and classify neurons in the vertebrate brain have been recently published (Cadwell et al 2016, Cembrowski et al 2016, Fuzik et al 2016, Harris et al 2018, La Manno et al 2016, Ren et al 2019, Tasic et al 2018, Yuste et al 2020, Zheng et al 2019). Nonetheless, several studies argue caution about reliance solely on molecular techniques to classify neurons.

September 28, 2020

One study, exploiting unambiguously identifiable crustacean neurons showed that clustering on the basis of molecular markers alone is only partially satisfactory (Northcutt et al 2019). A new study in mouse (Kim et al 2020) also argues that projection patterns are necessary to supplement molecular tools to unambiguously identify cell types. The present emphasis on establishing censuses of cell types (Ecker et al 2017, Jorgenson et al 2015) suggests that we should soon have much improved knowledge of cell types in many brains. Given that it is impossible to establish circuit wiring diagrams without good cell identification, there is every reason to hope that a great deal of progress will come shortly in these arenas.

Early work on “simple systems” (Getting 1989, Marder & Calabrese 1996) benefitted from preparations that generated behaviors *in vitro* that were recognizably similar to those generated *in vivo* by the intact animal, with easily measurable and quantifiable outputs. Today, single neuron and network activity can be measured and manipulated in behaving animals, using multielectrode recordings, patch-clamp recordings in freely moving animals or voltage-sensitive dye measurements combined with optogenetics or electrical nanostimulation techniques (Adam et al 2019, Chettih & Harvey 2019, Frank et al 2019, Tanke et al 2018, Yang & Yuste 2017, Zhang et al 2018). These technical advances now allow simultaneous recordings from hundreds of neurons *in vivo* (Adam et al 2019, Yang & Yuste 2017) and manipulations of their activity to probe the influence of single mammalian neurons on complex sensory-driven behaviors (Chettih & Harvey 2019, Doron & Brecht 2015, Tanke et al 2018). Nonetheless, it is still not clear what activity patterns are part of the repertoire of normal healthy brains,



complicating our understanding of how dynamics arise in normal, healthy brains, across individuals.

Neurons are frequently identified on the basis of their firing patterns. While this may be oftentimes reliable, there are circumstances in which firing patterns can be misleading. There are neurons that switch from being part of one circuit to being part of another (Dickinson et al 1990, Gutierrez & Marder 2014, Hooper & Moulins 1989, Weimann & Marder 1994). Therefore, the neuron's activity pattern and dynamics can be dramatically different in different circumstances. Parallel pathways, in which neurons are connected by multiple synaptic routes (Gutierrez & Marder 2014, Gutierrez et al 2013) may frequently contribute to these context and neuromodulation-dependent switches in activity patterns that can make cell identification based on firing properties ambiguous.

*In vivo* calcium imaging of hundreds of neurons in the hippocampus or the posterior parietal cortex in behaving animals show that learned sensory-motor tasks are associated with a stable network representation over periods of 10-40 days (Driscoll et al 2017, Ziv et al 2013). Surprisingly however, the individual neurons underlying these representations change over time, such that only 2-25% of the recorded neurons reliably encode the same information over long periods of time, with most neurons changing their response specificity from trial to trial. These results suggest that neuronal representations are highly degenerate, such that network-level encoding can be preserved in spite of large variations in the roles of individual neurons (Rule et al 2019). A similar variable participation in stereotyped motor patterns is seen in the mollusk, *Tritonia* (Hill et al 2012).

The electrophysiological phenotype of mammalian neurons is variable even within a single well-identified neuronal type (Amendola et al 2012, Battaglia et al 2013, Deister et al 2013, Dufour et al 2014, Moubarak et al 2019, Pastoll et al 2020). In a recent elegant study, Pastoll and colleagues (2020) compared the intra- and inter-animal variability of electrophysiological properties of medial entorhinal cortex neurons, by performing up to 55 *in vitro* patch-clamp recordings from the same animal. The authors find that, although comparable in magnitude, intra- and inter-animal variabilities follow different rules. Within each animal, the excitability of these cortical neurons gradually changes along a dorso-ventral axis, but the average excitability of the population (set point) varies from animal to animal. This study underlines the extent to which similar behavioral performances may be achieved using multiple neuronal and network solutions.

### **Variability, Multiple Solutions, and Failure of Averaging**

Studying small nervous systems, in which it is possible to return to the same neurons and synapses from animal to animal, demonstrated that intrinsic and synaptic parameters vary 2-6 fold across animals when measured in uniquely identified neurons (Goaillard et al 2009, Goldman et al 2001, Golowasch 2014, Lamb & Calabrese 2013, Norris et al 2011, Northcutt et al 2019, Northcutt et al 2016, Roffman et al 2012, Schulz et al 2006, Schulz et al 2007, Temporal et al 2014, Tobin et al 2009). A 2-5 fold range in the conductance of potassium currents was observed in Lateral Pyloric (LP) neurons in the crab stomatogastric ganglion (STG) (**Figure 2a**) (Schulz et al 2006, Schulz et al 2007). Moreover, the genes encoding these currents displayed a similar range of variation and were correlated with the conductance values. Similar data come from

September 28, 2020

mammalian neurons for voltage-gated ion currents (**Figure 2b**) (Amendola et al 2012, Engel & Seutin 2015, Gentet & Williams 2007, Liss et al 2001, Moubarak et al 2019, Puopolo et al 2007, Seutin & Engel 2010, Swensen & Bean 2005). In substantia nigra dopaminergic neurons, gating properties such as voltage-dependence also varies across neurons (**Figure 2b**) (Amendola et al 2012).

Computational models demonstrate that similar neuronal and network behavior can be produced by widely disparate sets of parameters (**Figure 2c**) (Alonso & Marder 2019, Alonso & Marder 2020, Goldman et al 2001, O'Leary et al 2014, Prinz et al 2004). An interesting consequence of the structure of this variability is the potential for “failures of averaging” (Golowasch et al 2002). In this study the authors found 150 single-spike bursters in a population of about 5000 models. While the single spike bursters have almost identical waveforms, their sodium and delayed rectifier currents vary considerably. When a model was constructed from the mean values of those currents, the model failed to display the behavior of all of the models that were averaged in the mean! Similar issues can arise in functional imaging data of human brains.

Failure of averaging need not occur, but this example should be a warning to all who routinely assume that mean values are representative of all of the individuals who have contributed to those means. While means are often instructive, whenever there are latent and unknown multiple classes of individuals that have been grouped together, calculating means can hide the salient features in the data. Even when means themselves are accurate, oftentimes the variance and correlations in two or more groups of measurements are more important than the means. An experimental treatment might not change the mean of the population but could appreciably change the variance or the

normality of the data. In networks with large numbers of neurons that vary in properties, this diversity may expand the ability of the network to respond to a more diverse set of inputs than might occur if the neurons were more similar.

While specific functions are often attributable to a limited number of neurons in small invertebrate networks such as the STG (Calabrese et al 2011, Marder & Bucher 2007, Marder & Calabrese 1996), even in small networks changes in the number of neurons of a given type can be compensated by changes elsewhere (Daur et al 2012). Similarly, network function rather than specific single-neuron outputs may be maintained in larger mammalian networks (Driscoll et al 2017, Ziv et al 2013).

### **Consequences of ion channel degeneracy for variability and robustness to pharmacology, perturbations and neuromodulation.**

Animal toxins targeting ion channels have been invaluable in deciphering the influence of specific voltage-gated channels on neuronal activity (Kalia et al 2015). However, the effect of a given toxin applied at a fixed concentration on individual neurons of the same type is rarely quantitatively constant (Amendola et al 2012, Khaliq & Raman 2006, Puopolo et al 2007, Ransdell et al 2013). This variability can be so large that the role of specific ion channels may be questioned (Drion et al 2011). Puopolo and Bean (2007) demonstrated that the respective influence of sodium and L-type calcium channels on spontaneous tonic firing of midbrain dopaminergic neurons can vary in an almost all-or-none manner (**Figure 3a**). Similar to data from Purkinje neurons (Swensen & Bean 2005), the charge carried by the sodium and calcium channels displays large cell-to-cell variations, such that their respective contribution to the

depolarizing drive of these neurons can be major or negligible (**Figure 3b**).

Computational modelling helps understand this puzzling finding, by showing that models with neighboring values in functionally overlapping ion currents can react in qualitatively different ways to ion current block (Alonso & Marder 2019, Drion et al 2011), due to the specific shape of the parameter space (**Figure 3c**).

Degeneracy in ion channel function, while being responsible for counter-intuitive pharmacological results, explains the surprising robustness of neuronal activity to many perturbations. While many ion channel knock-outs fail to show a "clear" phenotype, compensatory changes in functionally overlapping channels can be responsible for the absence of alteration in activity (Chan et al 2007, Deignan et al 2012, Nerbonne et al 2008, Swensen & Bean 2005). Degeneracy may also explain why mutations in ion channels may not have additive aggravating influences on excitability pathologies (Glasscock et al 2007, Klassen et al 2011). While Kv1.1 and Cav1.1 losses of function are associated with limbic seizures and absence epilepsy, respectively, combining both genetic alterations decreases the severity of either phenotype (Glasscock et al 2007).

Similarly, an exome-sequencing study revealed that healthy human subjects with no neuropathological history could harbor up to 7 epilepsy-related mutations in ion channel genes, although epileptic patients sometimes displayed only one of these genetic alterations (Klassen et al 2011). Rather than the number of mutations, the functional synergy or antagonism of the mutated ion channels seems key in explaining the pathological outcome. Conversely, these observations may explain the observed variability in drug effects among individuals (Sarkar & Sobie 2011), and why targeting

single ion channels may be ineffective in treating some excitability pathologies (Goaillard & Dufour 2014, Ratte et al 2014).

Degeneracy in ion channels may also provide robustness in response to neuromodulators. Numerous neuromodulators modify neuronal activity by acting on voltage- and calcium-gated conductances through second-messenger signaling pathways (Harris-Warrick & Johnson 2010, Hille 1992, Hille 2001, Kaczmarek & Levitan 1987, Levitan 1988, Nadim & Bucher 2014, Palacios-Filardo & Mellor 2019). Due to the structure of intracellular signaling pathways, the action of a neuromodulator is often not restricted to one type of ion channel (Bucher & Marder 2013, Nadim & Bucher 2014), as is elegantly seen in the actions of dopamine in the crustacean pyloric network (Harris-Warrick 2011, Harris-Warrick et al 1995a, Harris-Warrick et al 1995b, Harris-Warrick & Johnson 2010). **Figure 4a** shows that dopamine affects multiple conductances in each of the six neuronal types of this network. Most of these effects are synergistic, as hyperpolarizing and depolarizing conductances are modulated in opposite ways.. Dopamine induces a decrease in  $I_A$  and an increase in  $I_h$  in 3 cell types (AB, PY, LP) while it modulates  $I_A$  and  $I_{Ca}$  in opposite directions in both PD and IC. Acting on many conductances could ensure that the effect of dopamine remains stable in the face of the variability in expression/conductance of ion channels described earlier.

In the STG , there are also a number of peptides that converge to act on a single current (Marder 2012, Swensen & Marder 2000, Swensen & Marder 2001). However, most peptides are released as cotransmitters, so that, by a different mechanism, multiple postsynaptic actions may be coordinately modulated (Bargmann 2012, Bargmann & Marder 2013, Blitz & Nusbaum 2011, Nusbaum et al 2017).

To what extent does modulation of a single target neuron, or class of neurons, influence only those neurons that are directly targeted by the modulator, or are there indirect actions that percolate through a network because of interactions from the direct targets of modulators to other neurons? Gutierrez and Marder (2014) used a computational model to show that the effects of modulation of a single hub neuron could either remain restricted to the direct target, or influence other neurons, depending on the specific strengths of the synaptic connections in the network (**Figure 4b**). Thus, networks with similar "basal" activity can reveal their underlying differences in response to a specific stimulation/perturbation. In this case, the two models appear "equivalent" when unchallenged, but their underlying parameter differences substantially influence the network consequence of the neuromodulator (**Figure 4b**). Similar results in which parameter differences between individuals are cryptic under control conditions, but are revealed in response to perturbation complicates understanding neuronal and network dynamics (Alonso & Marder 2020, Haddad & Marder 2018, Haley et al 2018, Sakurai et al 2014).

### **Covariation of system components**

Theoretical studies have demonstrated that the same phenotype can be produced by multiple biophysical solutions (Achard & De Schutter 2006, Alonso & Marder 2019, Goldman et al 2001, Golowasch et al 2002, O'Leary et al 2014, Prinz et al 2004, Taylor et al 2009). Biological observations have demonstrated that the expression levels and properties of voltage- and calcium-gated ion channels are highly variable from neuron to neuron (Amendola et al 2012, Engel & Seutin 2015, Gentet & Williams 2007, Liss et al

2001, Moubarak et al 2019, Puopolo et al 2007, Schulz et al 2006, Schulz et al 2007, Tapia et al 2018, Tobin et al 2009), and show significant correlations in their expression levels and/or their properties (**Figure 5**) (Amendola et al 2012, Cao & Oertel 2011, Cao & Oertel 2017, Cembrowski et al 2016, Fujita et al 2020, Goillard et al 2009, Iacobas et al 2019, Khorkova & Golowasch 2007, Kodama et al 2020, MacLean et al 2005, MacLean et al 2003, Schulz et al 2007, Tapia et al 2018, Temporal et al 2012, Temporal et al 2014, Tobin et al 2009).

The simultaneous quantification of mRNA expression levels of 6 different ion channels in 6 STG neuronal classes demonstrated that different subsets of ion channels displayed positive linear correlations in 5 out of 6 cell types (**Figure 5a**). When two ion channels were correlated in different cell types, the slope of the correlation varied (Schulz et al 2007), as also was found in a recent model of homeostatic regulation of intrinsic excitability (O'Leary et al 2013, O'Leary et al 2014). Therefore, each cell type appears to display a unique quantitative signature described by the pairwise relationships in ion channel expression levels (**Figure 5b**). Soofi et al (2012) experimentally and computationally explored the role of these correlations in the specific firing phase of action potentials in STG burst discharges.

This hypothesis that ion channel correlations and cell identity are linked is reinforced by a recent study in mouse midbrain dopaminergic neurons (Tapia et al 2018). Microfluidic qPCR quantification of a vast cohort of ion channels and dopamine signaling genes revealed that several somato-dendritic ion channels were strongly correlated with each other and with the genes involved in dopamine metabolism and signaling (synthesis enzymes, dopamine transporters, dopamine receptor) (**Figure**



**5c,d**). Although this neuronal population is diverse and heterogeneous with respect to specific genetic markers and its vulnerability to pathological conditions (La Manno et al 2016, Poulin et al 2016, Poulin et al 2014, Tapia et al 2018), these correlations between ion channels and neurotransmitter identity are present in all midbrain dopaminergic neurons.

The idea that modules of correlated ion channels may be conserved in closely-related subpopulations of neurons is corroborated by recent studies in the hippocampus and in the vestibular and cerebellar nuclei (Cembrowski et al 2016, Fujita et al 2020, Kodama et al 2020). Kodama and colleagues (2020) investigated the patterns of expression of multiple ion channels in 5 different fast-spiking neuronal types from the medial vestibular nucleus (**Figure 5e**) and found a module of strongly-correlated ion channels, corresponding to channels involved in the depolarizing and repolarizing phases of the action potential. This module was mostly conserved across the 5 cell types, although the absolute level of expression of the ion channels increased with the average firing rate of the neuronal type. The authors concluded that the module of correlated ion channels represents a robust solution to fast-spiking (Kodama et al 2020). Similar to midbrain dopaminergic neurons (Tapia et al 2018), these results highlight that neighboring cell types may be organized in a continuum of gene expression rather than in discrete clusters with well-separated expression levels, consistent with studies on hippocampus CA1 pyramidal and inhibitory neurons (Cembrowski et al 2016, Harris et al 2018).

Conductance levels, voltage-dependences or gating kinetics of functionally overlapping channels may also co-vary in specific cell types (Amendola et al 2012, Cao &

Oertel 2011, Cao & Oertel 2017, Khorkova & Golowasch 2007, MacLean et al 2005, McAnelly & Zakon 2000, McAnelly & Zakon 2007, Stoddard et al 2006, Temporal et al 2012). Observations made at the gene expression level in the STG were corroborated by voltage-clamp recordings: in the case of  $I_A$  and  $I_h$ , the maximal conductances of the two currents were positively correlated with each other in several cell types (Khorkova & Golowasch 2007, MacLean et al 2005, Temporal et al 2012). Moreover, this correlation has a homeostatic impact on firing, as it preserved network cycle period or phase relationships (MacLean et al 2003, Soofi et al 2012, Zhao & Golowasch 2012). A similar situation is encountered in the mouse ventral cochlear nucleus, where the resting membrane potential of octopus, bushy and T stellate cells is controlled by the combined action of  $I_h$  and a low-threshold potassium current ( $I_{KL}$ ) (Cao & Oertel 2011). The magnitudes of the two currents co-vary across cell types and across wild-type strains of mice, such that they balance each other at resting membrane potential (Cao & Oertel 2011, Cao & Oertel 2017). The cell-to-cell variations in resting potential and the associated variations in magnitude of  $I_h$  and  $I_{KL}$  led the authors to postulate that the magnitude of the two currents is controlled by the value of the resting potential (Cao & Oertel 2017).

Co-regulation of ion channels can promote efficient tuning of intrinsic properties. The voltage sensitivities of  $I_h$  and  $I_A$  are positively correlated in substantia nigra dopaminergic neurons, and this is controlled by  $Ca^{2+}$  and cAMP (Amendola et al 2012). While a dynamic clamp-imposed covariation of  $I_h$  and  $I_A$  maximal conductances stabilizes the post-inhibitory rebound delay of these cells, the co-regulation of their voltage-dependences increases the dynamic range of the rebound delay.

A beautiful examples of ethologically-relevant co-regulation of ion channels is seen in the weakly electric fish *Sternopygus* (Ferrari et al 1995, McAnelly & Zakon 2000, McAnelly & Zakon 2007, Stoddard et al 2006). The variation in frequency of the electrical signals emitted by the fish's electrocytes is associated with significant variations in action potential duration, to maintain duty cycle. In elegant studies, Zakon's group demonstrated that the tuning of action potential width relies on the co-regulation of the inactivation kinetics of the transient sodium current and the activation and deactivation of the delayed rectifier potassium current (McAnelly & Zakon 2000, McAnelly & Zakon 2007).

### **Etiology and functional implications of covariation**

Although neurons and networks with similar performance can display variable parameter sets, random selections of parameter values are highly unlikely to produce a characteristic behavior (Caplan et al 2014, Prinz et al 2004). This means that animals must employ strategies for finding sets of successful solutions. One appealing hypothesis is that coordinating the expression of functionally overlapping channels (rather than controlling each ion channel's expression individually) would ensure that critical electrophysiological features are robustly achieved.

In fast-spiking vestibular neurons, the expression levels of axonal ion channels essential to fast depolarization and repolarization of the action potential are strongly correlated (**Figure 5e**) and also correlated with the axonal cytoskeleton protein neurofilament, suggesting a common transcriptional regulatory mechanism (Kodama et al 2020). Relying on a single regulatory mechanism to express this axonal module of

genes may represent an efficient way to ensure that fast-spiking is invariably achieved in these neurons. In midbrain dopaminergic neurons (**Figure 5c,d**) the strongly correlated ion channels are mainly somato-dendritic and their levels of expression are strongly correlated with genes involved in dopaminergic signaling (Tapia et al 2018). In these neurons dopamine is released from axon terminals and from the dendrites. This dendritic release relies on the faithful back-propagation of action potentials (Vandecasteele et al 2008). Thus the module of correlated genes, suggestive of a common transcriptional regulatory mechanism, may represent an effective way to ensure that faithful action potential back-propagation and dopamine dendritic release are invariably found in these neurons.

Although the hypothesized common regulatory mechanisms responsible for these correlations in expression have not been identified, activity-dependent mechanisms may be involved (Iacobas et al 2019, Klein et al 2003, O'Leary et al 2013, O'Leary et al 2014). Theoretical studies have demonstrated that correlations in conductance values can arise from simple  $\text{Ca}^{2+}$ -mediated homeostatic feedback rules linking variations in activity to the expression of ion channels (O'Leary et al 2013, O'Leary et al 2014). This work predicted that the variation in slope of the correlations might result from the specific kinetics of regulation of expression of each ion channel gene (O'Leary et al 2014). Experimental studies suggest that ion channel expression is co-regulated in an activity-dependent manner. While it had been already shown that the expression of two types of sodium channels (Nav1.8 and Nav1.9) in dorsal root ganglion neurons was down-regulated by patterned electrical stimulation (Klein et al 2003), a recent study shows that more than 20 types of voltage-gated ion channels are up- or down-regulated in

response to specific patterns of stimulation (Iacobas et al 2019). Most of these channels share correlations in the unstimulated condition, but the correlations are reinforced and sometimes modified by specific patterns of activity. These results are reminiscent of the work done on the crab STG, where some of the correlations in ion channel expression were sensitive to changes in network activity (Temporal et al 2014).

Intriguingly, most (if not all) of the correlations in expression of ion channels correspond to positive quasi-linear correlations (Iacobas et al 2019, Kodama et al 2020, Schulz et al 2007, Tapia et al 2018, Temporal et al 2012, Temporal et al 2014, Tobin et al 2009). This biological finding is surprising when compared to the shape of conductance spaces obtained in computational models (e.g. the negative slope of the  $g_{Ca}/g_{Na}$  boundary in **Figure 3c**). Several computational studies demonstrated that stable model activity relies on both positive and negative correlations between conductance densities (Lamb & Calabrese 2013, Soofi et al 2012, Taylor et al 2009). Lamb and Calabrese (2013) found that opposing conductances tended to share positive correlations while compensatory conductances were negatively correlated. In theory, transcriptional regulation can lead to positive or negative relationships in the levels of expression of the targeted genes. Why then are positive correlations preferentially observed in biological neurons? Perhaps these positive correlations are a side-product of the necessity to express ion channels as functional modules. Ensuring that all of the ion channels pertaining to a same module are expressed together would be achieved by the use of a common regulatory signal (transcription factor, homeostatic  $Ca^{2+}$ -mediated feedback), and would produce positive correlations in their expression levels. The fact that some of the correlations observed at the gene level may be modified or modulated

differently at the ion current level (Temporal et al 2012) is consistent with such an hypothesis.

Some of the correlations in ion channel expression/conductance may not simply be side-products of common genetic regulatory mechanisms but functionally important (Cao & Oertel 2011, Cao & Oertel 2017, MacLean et al 2005, MacLean et al 2003, Zhao & Golowasch 2012). In the cases of the  $I_h/I_A$  correlation in pyloric pacemaker neurons or  $I_h/I_{KL}$  in cochlear neurons the co-regulation of the ion channels has a stabilizing impact on specific electrophysiological features, as functionally-opposing currents compensate for each other, as long as their magnitudes co-vary. Thus, covariation in expression may stabilize firing properties while allowing variations in single ion channel expression/properties. Rather than hindering network function, the tolerated variations in ion channel properties would increase neuronal biophysical diversity in the network, which can improve network information storage and robustness in response to perturbations (Ahn et al 2014, Hofmann & Chacron 2020, Padmanabhan & Urban 2010, Ransdell et al 2012, Rathour & Narayanan 2019, Tripathy et al 2013).

### **Embracing the complexity of neuron and network function**

The relationship between system components and neuron/network function is a many-to-one correspondence, with multiple degenerate solutions producing "equivalent" electrophysiological phenotypes (*see **Figure 6** for a graphical summary of the main points addressed in the review*). This is tantamount to saying that the dimensionality of parameter spaces is higher than the dimensionality of phenotypic spaces. While this discrepancy might be real and used to find new behavioral solutions

in response to changes in the environment (evolvability) (Wagner 2005, Whitacre & Bender 2010), caution is required in defining the dimensionality of both the ionic conductance space and electrophysiological phenotypes.

On one hand, depending on the preparation studied, accurately defining ethologically-relevant phenotypes can be far more daunting than it may seem. Similar phenotypes under stated control conditions can hide cryptic differences in behavior that are only revealed after significant perturbations (Alonso & Marder 2020, Haddad & Marder 2018, Hamood & Marder 2015, Sakurai et al 2014). Moreover, what appears to be “similar” phenotype may, in fact, also be hiding other behavioral states, not yet characterized. The crabs and lobsters used to study the STG are 5-7 years old, and surviving in the wild implies that their overall phenotype is fit. The fact that the STG generates an *in vitro* activity very similar to the *in vivo* one then ensures the experimenter that the recorded network activity is biologically relevant. The challenge is more difficult when trying to relate ion channel properties to neuronal function in mammalian neurons. Notwithstanding that housing and rearing conditions of laboratory rodents are more permissive than the conditions of survival in the wild, single-neuron firing patterns *in vitro* don't capture the complexity of *in vivo* activity. Thus, it is likely that the dimensionality of the electrophysiological phenotypes are underestimated.

On the other hand, experimental studies suggest that the multiple solutions of ion channel properties generating a similar phenotype are not random but structured (**Figure 5**). Although theoretical and experimental studies suggested that much of the structure of biological systems is captured in pairwise interactions (Bialek &

Ranganathan 2007, Schneidman et al 2006), a significant part of the structure of ion channel parameter space may be contained in higher-order relationships. The use of multivariate mutual information analysis (Baudot & Bennequin 2015, Baudot et al 2019), which allows the quantification of statistical dependencies at any dimension (pairs, triplets, quadruplets, quintuplets...), demonstrated that ~40% of the mutual information shared by the correlated ion channels in midbrain dopaminergic neurons is contained in higher-than-pairwise interactions (Tapia et al 2018). Limiting the analysis of ion channels to univariate or pairwise analysis may lead to underestimating the complexity of parameter spaces.

Thus, despite the remarkable advances of recent years in the analyses of genes expressed in single neurons, the challenge of understanding how ion channels determine neuron and circuit resilience remains as daunting as ever.

## REFERENCES

- Achard P, De Schutter E. 2006. Complex parameter landscape for a complex neuron model. *PLoS Comput Biol* 2: e94
- Adam Y, Kim JJ, Lou S, Zhao YX, Xie ME, et al. 2019. Voltage imaging and optogenetics reveal behaviour-dependent changes in hippocampal dynamics. *Nature* 569: 413-17
- Ahn J, Kreeger LJ, Lubejko ST, Butts DA, MacLeod KM. 2014. Heterogeneity of intrinsic biophysical properties among cochlear nucleus neurons improves the population coding of temporal information. *Journal of Neurophysiology* 111: 2320-31
- Alonso LM, Marder E. 2019. Visualization of currents in neural models with similar behavior and different conductance densities. *Elife* 8: e42722
- Alonso LM, Marder E. 2020. Temperature compensation in a small rhythmic circuit. *Elife* 9: e55470
- Amendola J, Woodhouse A, Martin-Eauclaire MF, Goillard JM. 2012. Ca<sup>2+</sup>/cAMP-sensitive covariation of I(A) and I(H) voltage dependences tunes rebound firing in dopaminergic neurons. *J Neurosci* 32: 2166-81



- Bargmann CI. 2012. Beyond the connectome: how neuromodulators shape neural circuits. *Bioessays* 34: 458-65
- Bargmann CI, Marder E. 2013. From the connectome to brain function. *Nature methods* 10: 483-90
- Battaglia D, Karagiannis A, Gallopin T, Gutch HW, Cauli B. 2013. Beyond the frontiers of neuronal types. *Frontiers in neural circuits* 7: 13
- Baudot P, Bennequin D. 2015. The Homological Nature of Entropy. *Entropy-Switz* 17: 3253-318
- Baudot P, Tapia M, Bennequin D, Goillaud JM. 2019. Topological Information Data Analysis. *Entropy-Switz* 21
- Beverly M, Anbil S, Sengupta P. 2011. Degeneracy and neuromodulation among thermosensory neurons contribute to robust thermosensory behaviors in *Caenorhabditis elegans*. *J Neurosci* 31: 11718-27
- Bialek W, Ranganathan R. 2007. Rediscovering the power of pairwise interactions. pp. arXiv:0712.4397
- Blitz DM, Nusbaum MP. 2011. Neural circuit flexibility in a small sensorimotor system. *Curr Opin Neurobiol* 21: 544-52
- Bucher D, Marder E. 2013. SnapShot: Neuromodulation. *Cell* 155: 482-82 e1
- Cadwell CR, Palasantza A, Jiang X, Berens P, Deng Q, et al. 2016. Electrophysiological, transcriptomic and morphologic profiling of single neurons using Patch-seq. *Nat Biotechnol* 34: 199-203
- Calabrese RL, Norris BJ, Wenning A, Wright TM. 2011. Coping with variability in small neuronal networks. *Integrative and comparative biology* 51: 845-55
- Cao XJ, Oertel D. 2011. The magnitudes of hyperpolarization-activated and low-voltage-activated potassium currents co-vary in neurons of the ventral cochlear nucleus. *Journal of Neurophysiology* 106: 630-40
- Cao XJ, Oertel D. 2017. Genetic perturbations suggest a role of the resting potential in regulating the expression of the ion channels of the KCNA and HCN families in octopus cells of the ventral cochlear nucleus. *Hearing Res* 345: 57-68
- Caplan JS, Williams AH, Marder E. 2014. Many parameter sets in a multicompartiment model oscillator are robust to temperature perturbations. *J Neurosci* 34: 4963-75
- Cembrowski MS, Bachman JL, Wang L, Sugino K, Shields BC, Spruston N. 2016. Spatial Gene-Expression Gradients Underlie Prominent Heterogeneity of CA1 Pyramidal Neurons. *Neuron* 89: 351-68
- Chan CS, Guzman JN, Ilijic E, Mercer JN, Rick C, et al. 2007. 'Rejuvenation' protects neurons in mouse models of Parkinson's disease. *Nature* 447: 1081-6
- Chettih SN, Harvey CD. 2019. Single-neuron perturbations reveal feature-specific competition in V1. *Nature* 567: 334-40
- Connor JA, Stevens CF. 1971. Prediction of repetitive firing behaviour from voltage clamp data on an isolated neurone soma. *J Physiol (Lond)* 213: 31-53
- Cropper EC, Dacks AM, Weiss KR. 2016. Consequences of degeneracy in network function. *Curr Opin Neurobiol* 41: 62-67
- Daur N, Bryan AS, Garcia VJ, Bucher D. 2012. Short-term synaptic plasticity compensates for variability in number of motor neurons at a neuromuscular junction. *J Neurosci* 32: 16007-17
- Deignan J, Lujan R, Bond C, Riegel A, Watanabe M, et al. 2012. SK2 and SK3 expression differentially affect firing frequency and precision in dopamine neurons. *Neuroscience* 217: 67-76
- Deister CA, Dodla R, Barraza D, Kita H, Wilson CJ. 2013. Firing rate and pattern heterogeneity in the globus pallidus arise from a single neuronal population. *Journal of Neurophysiology* 109: 497-506
- Dickinson PS, Meccas C, Marder E. 1990. Neuropeptide fusion of two motor pattern generator circuits. *Nature* 344: 155-58
- Doron G, Brecht M. 2015. What single-cell stimulation has told us about neural coding. *Philos T R Soc B* 370

September 28, 2020

- Drion G, Massotte L, Sepulchre R, Seutin V. 2011. How modeling can reconcile apparently discrepant experimental results: the case of pacemaking in dopaminergic neurons. *PLoS Comput Biol* 7: e1002050
- Driscoll LN, Pettit NL, Minderer M, Chettih SN, Harvey CD. 2017. Dynamic Reorganization of Neuronal Activity Patterns in Parietal Cortex. *Cell* 170: 986-99
- Dufour MA, Woodhouse A, Amendola J, Goillard JM. 2014. Non-Linear Developmental Trajectory of Electrical Phenotype in Rat Substantia Nigra Pars Compacta Dopaminergic Neurons. *eLife* 3: e04059
- Ecker JR, Geschwind DH, Kriegstein AR, Ngai J, Osten P, et al. 2017. The BRAIN Initiative Cell Census Consortium: Lessons Learned toward Generating a Comprehensive Brain Cell Atlas. *Neuron* 96: 542-57
- Edelman GM, Gally JA. 2001. Degeneracy and complexity in biological systems. *Proc Natl Acad Sci U S A* 98: 13763-8
- Engel D, Seutin V. 2015. High dendritic expression of Ih in the proximity of the axon origin controls the integrative properties of nigral dopamine neurons. *J Physiol* 593: 4905-22
- Ferrari MB, McAnelly ML, Zakon HH. 1995. Individual variation in and androgen-modulation of the sodium current in electric organ. *J Neurosci* 15: 4023-32
- Frank JA, Antonini MJ, Anikeeva P. 2019. Next-generation interfaces for studying neural function. *Nature Biotechnology* 37: 1013-23
- Fujita H, Kodama T, du Lac S. 2020. Modular output circuits of the fastigial nucleus for diverse motor and nonmotor functions of the cerebellar vermis. *eLife* 9: e58613
- Fuzik J, Zeisel A, Mate Z, Calvigioni D, Yanagawa Y, et al. 2016. Integration of electrophysiological recordings with single-cell RNA-seq data identifies neuronal subtypes. *Nat Biotechnol* 34: 175-83
- Gentet LJ, Williams SR. 2007. Dopamine gates action potential backpropagation in midbrain dopaminergic neurons. *J Neurosci* 27: 1892-901
- Getting PA. 1989. Emerging principles governing the operation of neural networks. *Annu Rev Neurosci* 12: 185-204
- Glasscock E, Qian J, Yoo JW, Noebels JL. 2007. Masking epilepsy by combining two epilepsy genes. *Nature Neuroscience* 10: 1554-58
- Goillard JM, Dufour MA. 2014. The pros and cons of degeneracy. *eLife* 3: e02615
- Goillard JM, Taylor AL, Schulz DJ, Marder E. 2009. Functional consequences of animal-to-animal variation in circuit parameters. *Nat Neurosci* 12: 1424-30
- Goldman MS, Golowasch J, Marder E, Abbott LF. 2001. Global structure, robustness, and modulation of neuronal models. *J Neurosci* 21: 5229-38
- Golowasch J. 2014. Ionic Current Variability and Functional Stability in the Nervous System. *Bioscience* 64: 570-80
- Golowasch J, Buchholtz F, Epstein IR, Marder E. 1992. Contribution of individual ionic currents to activity of a model stomatogastric ganglion neuron. *J Neurophysiol* 67: 341-9
- Golowasch J, Goldman MS, Abbott LF, Marder E. 2002. Failure of averaging in the construction of a conductance-based neuron model. *J Neurophysiol* 87: 1129-31
- Griffith LC. 2012. Identifying behavioral circuits in *Drosophila melanogaster*: moving targets in a flying insect. *Curr Opin Neurobiol* 22: 609-14
- Gunay C, Edgerton JR, Jaeger D. 2008. Channel density distributions explain spiking variability in the globus pallidus: a combined physiology and computer simulation database approach. *J Neurosci* 28: 7476-91

- Gutierrez GJ, Marder E. 2014. Modulation of a single neuron has state-dependent actions on circuit dynamics. *eNeuro* 1: 0009-14. PMID: PMC4596081
- Gutierrez GJ, O'Leary T, Marder E. 2013. Multiple mechanisms switch an electrically coupled, synaptically inhibited neuron between competing rhythmic oscillators. *Neuron* 77: 845-58
- Haddad SA, Marder E. 2018. Circuit Robustness to Temperature Perturbation Is Altered by Neuromodulators. *Neuron* 100: 609-23
- Haley JA, Hampton D, Marder E. 2018. Two central pattern generators from the crab, *Cancer borealis*, respond robustly and differentially to extreme extracellular pH. *Elife* 7: e4187
- Hamood AW, Marder E. 2015. Consequences of acute and long-term removal of neuromodulatory input on the episodic gastric rhythm of the crab *Cancer borealis*. *J Neurophysiol* 114: 1677-92
- Harris KD, Hochgerner H, Skene NG, Magno L, Katona L, et al. 2018. Classes and continua of hippocampal CA1 inhibitory neurons revealed by single-cell transcriptomics. *Plos Biology* 16
- Harris-Warrick RM. 2011. Neuromodulation and flexibility in Central Pattern Generator networks. *Curr Opin Neurobiol* 21: 655-92
- Harris-Warrick RM, Coniglio LM, Barazangi N, Guckenheimer J, Gueron S. 1995a. Dopamine modulation of transient potassium current evokes phase shifts in a central pattern generator network. *J Neurosci*. 15: 342-58
- Harris-Warrick RM, Coniglio LM, Levini RM, Gueron S, Guckenheimer J. 1995b. Dopamine modulation of two subthreshold currents produces phase shifts in activity of an identified motoneuron. *J Neurophysiol* 74: 1404-20
- Harris-Warrick RM, Johnson BR. 2010. Checks and balances in neuromodulation. *Front Behav Neurosci* 4: doi: 10.3389/fnbeh.2010.00047
- Hill ES, Vasireddi SK, Bruno AM, Wang J, Frost WN. 2012. Variable Neuronal Participation in Stereotypic Motor Programs. *PLoS One* 7: e40579
- Hille B. 1992. G protein-coupled mechanisms and nervous signaling. *Neuron* 9: 187-95
- Hille B. 2001. *Ion Channels of Excitable Membranes*. Sunderland, MA: Sinauer. 814 pp.
- Hofmann V, Chacron MJ. 2020. Neuronal On- and Off-type heterogeneities improve population coding of envelope signals in the presence of stimulus-induced noise. *Sci Rep-Uk* 10: 10194
- Hooper SL, Moulins M. 1989. Switching of a Neuron from One Network to Another by Sensory-Induced Changes in Membrane-Properties. *Science* 244: 1587-89
- Iacobas DA, Iacobas S, Lee PR, Cohen JE, Fields RD. 2019. Coordinated Activity of Transcriptional Networks Responding to the Pattern of Action Potential Firing in Neurons. *Genes-Basel* 10
- Jegla TJ, Zmasek CM, Batalov S, Nayak SK. 2009. Evolution of the human ion channel set. *Comb Chem High Throughput Screen* 12: 2-23
- Jorgenson LA, Newsome WT, Anderson DJ, Bargmann CI, Brown EN, et al. 2015. The BRAIN Initiative: developing technology to catalyse neuroscience discovery. *Philos Trans R Soc Lond B Biol Sci* 370
- Kaczmarek LK, Levitan IB. 1987. *Neuromodulation: The Biochemical Control of Neuronal Excitability*. New York: Oxford University Press.
- Kalia J, Milesu M, Salvatierra J, Wagner J, Klint JK, et al. 2015. From foe to friend: using animal toxins to investigate ion channel function. *J Mol Biol* 427: 158-75
- Kang K, Pulver SR, Panzano VC, Chang EC, Griffith LC, et al. 2010. Analysis of *Drosophila* TRPA1 reveals an ancient origin for human chemical nociception. *Nature* 464: 597-600
- Khaliq ZM, Raman IM. 2006. Relative Contributions of Axonal and Somatic Na Channels to Action Potential Initiation in Cerebellar Purkinje Neurons. *Journal of Neuroscience* 26: 1935-44
- Khorkova O, Golowasch J. 2007. Neuromodulators, not activity, control coordinated expression of ionic currents. *J Neurosci* 27: 8709-18
- Kim EJ, Zhang Z, Huang L, Ito-Cole T, Jacobs MW, et al. 2020. Extraction of Distinct Neuronal Cell Types from within a Genetically Continuous Population. *Neuron* 107: 274-82 e6

- Klassen T, Davis C, Goldman A, Burgess D, Chen T, et al. 2011. Exome sequencing of ion channel genes reveals complex profiles confounding personal risk assessment in epilepsy. *Cell* 145: 1036-48
- Klein JP, Tendi EA, Dib-Hajj SD, Fields RD, Waxman SG. 2003. Patterned electrical activity modulates sodium channel expression in sensory neurons. *Journal of Neuroscience Research* 74: 192-98
- Kodama T, Gittis AH, Shin MY, Kelleher K, Kolkman KE, et al. 2020. Graded Coexpression of Ion Channel, Neurofilament, and Synaptic Genes in Fast-Spiking Vestibular Nucleus Neurons. *Journal of Neuroscience* 40: 496-508
- La Manno G, Gyllborg D, Codeluppi S, Nishimura K, Salto C, et al. 2016. Molecular Diversity of Midbrain Development in Mouse, Human, and Stem Cells. *Cell* 167: 566-80 e19
- Lamb DG, Calabrese RL. 2013. Correlated conductance parameters in leech heart motor neurons contribute to motor pattern formation. *PLoS One* 8: e79267
- Levitan IB. 1988. Modulation of ion channels in neurons and other cells. *Annu Rev Neurosci* 11: 119-36
- Liss B, Franz O, Sewing S, Bruns R, Neuhoff H, Roeper J. 2001. Tuning pacemaker frequency of individual dopaminergic neurons by Kv4.3L and KChip3.1 transcription. *EMBO J* 20: 5715-24
- Littleton JT, Ganetzky B. 2000. Ion channels and synaptic organization: Analysis of the Drosophila genome. *Neuron* 26: 35-43
- Lizbinski KM, Marsat G, Dacks AM. 2018. Systematic Analysis of Transmitter Coexpression Reveals Organizing Principles of Local Interneuron Heterogeneity. *eNeuro* 5: .0212-18.201
- Lovell PV, Carleton JB, Mello CV. 2013. Genomics analysis of potassium channel genes in songbirds reveals molecular specializations of brain circuits for the maintenance and production of learned vocalizations. *Bmc Genomics* 14
- Ma M, Koester J. 1996. The role of K<sup>+</sup> currents in frequency-dependent spike broadening in Aplysia R20 neurons: a dynamic-clamp analysis. *J Neurosci* 16: 4089-101
- MacLean JN, Zhang Y, Goeritz ML, Casey R, Oliva R, et al. 2005. Activity-independent coregulation of I<sub>A</sub> and I<sub>h</sub> in rhythmically active neurons. *J Neurophysiol* 94: 3601-17
- MacLean JN, Zhang Y, Johnson BR, Harris-Warrick RM. 2003. Activity-independent homeostasis in rhythmically active neurons. *Neuron* 37: 109-20
- Marder E. 2012. Neuromodulation of neuronal circuits: back to the future. *Neuron* 76: 1-11
- Marder E, Bucher D. 2007. Understanding circuit dynamics using the stomatogastric nervous system of lobsters and crabs. *Annu Rev Physiol* 69: 291-316
- Marder E, Calabrese RL. 1996. Principles of rhythmic motor pattern generation. *Physiol. Rev.* 76: 687-717
- Marder E, Goaillard JM. 2006. Variability, compensation and homeostasis in neuron and network function. *Nat Rev Neurosci* 7: 563-74
- McAnelly ML, Zakon HH. 2000. Coregulation of voltage-dependent kinetics of Na<sup>(+)</sup> and K<sup>(+)</sup> currents in electric organ. *J Neurosci* 20: 3408-14
- McAnelly ML, Zakon HH. 2007. Androgen modulates the kinetics of the delayed rectifying K<sup>+</sup> current in the electric organ of a weakly electric fish. *Developmental Neurobiology* 67: 1589-97
- Migliore R, Lupascu CA, Bologna LL, Romani A, Courcol JD, et al. 2018. The physiological variability of channel density in hippocampal CA1 pyramidal cells and interneurons explored using a unified data-driven modeling workflow. *PLoS Comput Biol* 14: e1006423
- Moubarak E, Engel D, Dufour MA, Tapia M, Tell F, Goaillard JM. 2019. Robustness to Axon Initial Segment Variation Is Explained by Somatodendritic Excitability in Rat Substantia Nigra Dopaminergic Neurons. *Journal of Neuroscience* 39: 5044-63
- Nadim F, Bucher D. 2014. Neuromodulation of neurons and synapses. *Curr Opin Neurobiol* 29: 48-56
- Nerbonne JM, Gerber BR, Norris A, Burkhalter A. 2008. Electrical remodelling maintains firing properties in cortical pyramidal neurons lacking KCND2-encoded A-type K<sup>+</sup> currents. *J Physiol* 586: 1565-79

- Nirenberg M, Leder P, Bernfield M, Brimacombe R, Trupin J, et al. 1965. RNA codewords and protein synthesis, VII. On the general nature of the RNA code. *Proceedings of the National Academy of Sciences* 53: 1161-68
- Norris BJ, Wenning A, Wright TM, Calabrese RL. 2011. Constancy and variability in the output of a central pattern generator. *J Neurosci* 31: 4663-74
- Northcutt AJ, Kick DR, Otopalik AG, Goetz BM, Harris RM, et al. 2019. Molecular profiling of single neurons of known identity in two ganglia from the crab *Cancer borealis*. *Proc Natl Acad Sci U S A* 116: 26980-90
- Northcutt AJ, Lett KM, Garcia VB, Diester CM, Lane BJ, et al. 2016. Deep sequencing of transcriptomes from the nervous systems of two decapod crustaceans to characterize genes important for neural circuit function and modulation. *BMC genomics* 17: 868
- Northcutt AJ, Schulz DJ. 2019. Molecular mechanisms of homeostatic plasticity in central pattern generator networks. *Dev Neurobiol* 80: 58-69
- Nusbaum MP, Blitz DM, Marder E. 2017. Functional consequences of neuropeptide and small-molecule co-transmission. *Nat Rev Neurosci* 18: 389-403
- O'Leary T, Williams AH, Caplan JS, Marder E. 2013. Correlations in ion channel expression emerge from homeostatic tuning rules. *Proc Natl Acad Sci U S A* 110: E2645-54
- O'Leary T, Williams AH, Franci A, Marder E. 2014. Cell types, network homeostasis, and pathological compensation from a biologically plausible ion channel expression model. *Neuron* 82: 809-21
- Padmanabhan K, Urban NN. 2010. Intrinsic biophysical diversity decorrelates neuronal firing while increasing information content. *Nature Neuroscience* 13: 1276-82
- Palacios-Filardo J, Mellor JR. 2019. Neuromodulation of hippocampal long-term synaptic plasticity. *Curr Opin Neurobiol* 54: 37-43
- Pastoll H, Garden DL, Papastathopoulos I, Surmeli G, Nolan MF. 2020. Inter- and intra-animal variation in the integrative properties of stellate cells in the medial entorhinal cortex. *eLife* 9: e52258
- Poulin JF, Tasic B, Hjerling-Leffler J, Trimarchi JM, Awatramani R. 2016. Disentangling neural cell diversity using single-cell transcriptomics. *Nat Neurosci* 19: 1131-41
- Poulin JF, Zou J, Drouin-Ouellet J, Kim KY, Cicchetti F, Awatramani RB. 2014. Defining midbrain dopaminergic neuron diversity by single-cell gene expression profiling. *Cell Rep* 9: 930-43
- Prinz AA, Bucher D, Marder E. 2004. Similar network activity from disparate circuit parameters. *Nat Neurosci* 7: 1345-52
- Puopolo M, Raviola E, Bean BP. 2007. Roles of subthreshold calcium current and sodium current in spontaneous firing of mouse midbrain dopamine neurons. *J Neurosci* 27: 645-56
- Ransdell JL, Nair SS, Schulz DJ. 2012. Rapid homeostatic plasticity of intrinsic excitability in a central pattern generator network stabilizes functional neural network output. *J Neurosci* 32: 9649-58
- Ransdell JL, Nair SS, Schulz DJ. 2013. Neurons within the same network independently achieve conserved output by differentially balancing variable conductance magnitudes. *J Neurosci* 33: 9950-6
- Rathour RK, Narayanan R. 2014. Homeostasis of functional maps in active dendrites emerges in the absence of individual channelostasis. *P Natl Acad Sci USA* 111: E1787-E96
- Rathour RK, Narayanan R. 2019. Degeneracy in hippocampal physiology and plasticity. *Hippocampus* 29: 980-1022
- Ratte S, Zhu Y, Lee KY, Prescott SA. 2014. Criticality and degeneracy in injury-induced changes in primary afferent excitability and the implications for neuropathic pain. *eLife* 3: e02370
- Ren J, Isakova A, Friedmann D, Zeng JW, Grutzner SM, et al. 2019. Single-cell transcriptomes and whole-brain projections of serotonin neurons in the mouse dorsal and median raphe nuclei. *eLife* 8: e49424

- Roffman RC, Norris BJ, Calabrese RL. 2012. Animal-to-animal variability of connection strength in the leech heartbeat central pattern generator. *J Neurophysiol* 107: 1681-93
- Rule ME, O'Leary T, Harvey CD. 2019. Causes and consequences of representational drift. *Current Opinion in Neurobiology* 58: 141-47
- Sakurai A, Tamvacakis AN, Katz PS. 2014. Hidden synaptic differences in a neural circuit underlie differential behavioral susceptibility to a neural injury. *Elife* 3: e02598
- Sarkar AX, Sobie EA. 2011. Quantification of repolarization reserve to understand interpatient variability in the response to proarrhythmic drugs: A computational analysis. *Heart Rhythm* 8: 1749-55
- Schneidman E, Berry MJ, Segev R, Bialek W. 2006. Weak pairwise correlations imply strongly correlated network states in a neural population. *Nature* 440: 1007-12
- Schulz DJ, Goaillard JM, Marder E. 2006. Variable channel expression in identified single and electrically coupled neurons in different animals. *Nat Neurosci* 9: 356 - 62
- Schulz DJ, Goaillard JM, Marder EE. 2007. Quantitative expression profiling of identified neurons reveals cell-specific constraints on highly variable levels of gene expression. *Proc Natl Acad Sci U S A* 104: 13187-91
- Sengupta P, Garrity P. 2013. Sensing temperature. *Curr Biol* 23: R304-7
- Seutin V, Engel D. 2010. Differences in Na<sup>+</sup> conductance density and Na<sup>+</sup> channel functional properties between dopamine and GABA neurons of the rat substantia nigra. *J Neurophysiol* 103: 3099-114
- Soofi W, Archila S, Prinz AA. 2012. Co-variation of ionic conductances supports phase maintenance in stomatogastric neurons. *Journal of Computational Neuroscience* 33: 77-95
- Stoddard PK, Zakon HH, Markham MR, McAnelly L. 2006. Regulation and modulation of electric waveforms in gymnotiform electric fish. *J Comp Physiol A Neuroethol Sens Neural Behav Physiol* 192: 613-24
- Swensen AM, Bean BP. 2005. Robustness of burst firing in dissociated purkinje neurons with acute or long-term reductions in sodium conductance. *J Neurosci* 25: 3509-20
- Swensen AM, Marder E. 2000. Multiple peptides converge to activate the same voltage-dependent current in a central pattern-generating circuit. *J Neurosci* 20: 6752-9
- Swensen AM, Marder E. 2001. Modulators with convergent cellular actions elicit distinct circuit outputs. *J. Neurosci.* 21: 4050-8.
- Tanke N, Borst JGG, Houweling AR. 2018. Single-Cell Stimulation in Barrel Cortex Influences Psychophysical Detection Performance. *Journal of Neuroscience* 38: 2057-68
- Tapia M, Baudot P, Formisano-Treziny C, Dufour MA, Temporal S, et al. 2018. Neurotransmitter identity and electrophysiological phenotype are genetically coupled in midbrain dopaminergic neurons. *Sci Rep* 8: 13637
- Tasic B, Yao ZZ, Graybiuck LT, Smith KA, Nguyen TN, et al. 2018. Shared and distinct transcriptomic cell types across neocortical areas. *Nature* 563: 72-78
- Taylor AL, Goaillard JM, Marder E. 2009. How multiple conductances determine electrophysiological properties in a multicompartiment model. *J Neurosci* 29: 5573-86
- Temporal S, Desai M, Khorkova O, Varghese G, Dai A, et al. 2012. Neuromodulation independently determines correlated channel expression and conductance levels in motor neurons of the stomatogastric ganglion. *J Neurophysiol* 107: 718-27
- Temporal S, Lett KM, Schulz DJ. 2014. Activity-dependent feedback regulates correlated ion channel mRNA levels in single identified motor neurons. *Curr Biol* 24: 1899-904
- Tobin AE, Cruz-Bermudez ND, Marder E, Schulz DJ. 2009. Correlations in ion channel mRNA in rhythmically active neurons. *PLoS ONE* 4: e6742
- Tripathy SJ, Padmanabhan K, Gerkin RC, Urban NN. 2013. Intermediate intrinsic diversity enhances neural population coding. *P Natl Acad Sci USA* 110: 8248-53

- Vandecasteele M, Glowinski J, Deniau JM, Venance L. 2008. Chemical transmission between dopaminergic neuron pairs. *Proceedings of the National Academy of Sciences* 105: 4904-09
- Wagner A. 2005. *Robustness and evolvability in living systems*. Princeton, N.J. ; Woodstock: Princeton University Press. 1 v. pp.
- Weimann JM, Marder E. 1994. Switching neurons are integral members of multiple oscillatory networks. *Curr. Biol.* 4: 896-902
- Whitacre J, Bender A. 2010. Degeneracy: A design principle for achieving robustness and evolvability. *Journal of Theoretical Biology* 263: 143-53
- Yang W, Yuste R. 2017. In vivo imaging of neural activity (vol 14, pg 349, 2017). *Nature Methods* 14: 752-52
- Yu FH, Yarov-Yarovoy V, Gutman GA, Catterall WA. 2005. Overview of Molecular Relationships in the Voltage-Gated Ion Channel Superfamily. *Pharmacological Reviews* 57: 387-95
- Yuste R, Hawrylycz M, Aalling N, Aguilar-Valles A, Arendt D, et al. 2020. A community-based transcriptomics classification and nomenclature of neocortical cell types. *Nature Neuroscience*: epub ahead of print
- Zhang ZH, Russell LE, Packer AM, Gauld OM, Hausser M. 2018. Closed-loop all-optical interrogation of neural circuits in vivo. *Nature Methods* 15: 1037-40
- Zhao S, Golowasch J. 2012. Ionic current correlations underlie the global tuning of large numbers of neuronal activity attributes. *J Neurosci* 32: 13380-8
- Zheng Y, Liu P, Bai L, Trimmer JS, Bean BP, Ginty DD. 2019. Deep Sequencing of Somatosensory Neurons Reveals Molecular Determinants of Intrinsic Physiological Properties. *Neuron* 103: 598-616
- Ziv Y, Burns LD, Cocker ED, Hamel EO, Ghosh KK, et al. 2013. Long-term dynamics of CA1 hippocampal place codes. *Nature Neuroscience* 16: 264-66

## FIGURE LEGENDS

**Figure 1. Functional overlap of ion channels.** **a**, The generic principles of redundancy, degeneracy, pleiotropy and functional overlap. Redundancy: identical copies of the same component, x and x' performing the same function (A). Degeneracy: non-identical components, x and y perform the same function (B). Pleiotropy or plurifunctionality: biological components (w) are involved in two or more functional processes (A and B). Functional overlap: two pleiotropic components w and z are partially degenerate, and share a function ( B) while displaying distinct functional repertoires (A-B vs B-C). **b**, Degeneracy and functional overlap of voltage-gated ion

channels occur when they have overlapping voltage sensitivities and gating kinetics. Families of voltage-gated ion channels shown with approximations of their respective voltage-sensitivities (gaussian functions peaking at the activation  $V_{50}$ ) and activation/inactivation kinetics (on a logarithmic scale).

**Figure 2. Variability and multiple solutions. a,** Cell-to-cell variability in potassium conductances in crab lateral pyloric (LP) neurons. LP neurons *1* and *2* recorded from different animals with similar membrane potential waveforms (top row), but potassium currents,  $I_K$ ,  $I_{KCa}$  and  $I_A$ -type; middle row display significant variations in amplitude. A 2- to 5-fold range of variation is found in both conductance level and mRNA copy number for the genes encoding the corresponding ion channels (bottom row). The black and gray dots show data from LP neurons *1* and *2*. Scale bars: top traces, 10mV, 200ms; middle traces, 50nA, 100ms. Modified from Schulz et al (2006). **b,** Cell-to-cell variability of  $I_H$  and  $I_A$  in rat substantia nigra dopaminergic (DA) neurons. Neurons *1* and *2* are firing at similar frequencies (top row) but  $I_H$  and  $I_A$  are substantially different in amplitude (middle traces). A 2- to 5-fold range of variation in current amplitude in the sample of recorded neurons (bottom row left). A substantial cell-to-cell variation in voltage-dependence (15-20 mV range for both currents) was also observed. The black and gray dots indicate the data from DA neurons *1* and *2*. Bars: top 20mV, 1s, dotted line, -60mV; middle traces ( $I_H$ ), 500pA, 2s, dotted line indicates 0 pA; middle traces ( $I_A$ ), 4nA, 200ms, dotted line, 0 pA. Modified from Amendola et al (2012). **c,** Multiple solutions generate bursting activity with similar waveforms in single-compartment conductance-based models. Model neurons *1*, *2* and *3* show similar



bursting patterns of activity (middle black traces) with the maximal conductances ( $g_{\max}$ ) of their voltage-, calcium-gated and leak conductances (top row). The bottom graphs (currentscapes) are the total outward and inward currents (black currentscapes) and the contribution of each conductance (colored currentscapes) during a cycle of activity. The model-to-model variation in  $g_{\max}$  does not strictly predict the variation in the contribution of each of the conductances to activity. Modified from Alonso and Marder (2019).

**Figure 3. Ion channel degeneracy explains variable pharmacological effects.**

**a**, variable effects of sodium and calcium channel blockers in dissociated substantia nigra dopaminergic neurons. Left, 1 $\mu$ M TTX abolishes activity in neuron 1 (top) but incompletely blocks action potentials in neuron 2 (bottom). Right, line and scatter plot showing the effect of applying 1 $\mu$ M Nimodipine on spontaneous firing rate of dopaminergic neurons. The black line and dots correspond to the average effect of Nimodipine (n=17). Nimodipine effects are variable (green dots and lines), some neurons stop firing; others are barely affected. Modified from Puopolo et al (2007). **b**, variable contribution of sodium and calcium channels to the interspike depolarization in dissociated substantia nigra dopaminergic neurons. The sodium channel charge (red bars) and calcium channel charge (green bars) in 8 dopaminergic neurons spontaneously firing at different frequencies. Modified from Puopolo et al (2007). **c**, variable effects of sodium and L-type calcium channel blockade in a single-compartment conductance-based model of a substantia nigra dopaminergic neuron. Left, graph representing the

parameter space defined by the maximal conductances of the L-type calcium conductance and the sodium conductance. The blue area shows spontaneously firing (pacemaking) models, the white area shows silent models (hyperpolarization). Blocking the sodium channels ( $g_{Na} = 0$ ) or the L-type calcium channels ( $g_{Ca,L} = 0$ ) in 4 models (1, 2, 3, 4) with similar spontaneous firing patterns in control condition (black traces) and similar maximal conductance values for the two currents. Right, 4 models present different sensitivities to the simulated blockade of sodium ( $g_{Na}=0$ ) and calcium channels ( $g_{Ca,L}=0$ ): models 1 and 4 are sensitive to the blockade of only one species of channels, while model 2 and 3 are sensitive and insensitive to both channel blocks, respectively. In TTX, persistence of spontaneous activity is seen as subthreshold oscillations, due to the block of the sodium channels.. Modified from Drion et al (2011). Scale bars: **a**, 40mV (from -80 to -40mV), 5s. **c**, 80mV, 1s, horizontal dotted lines, 0mV.

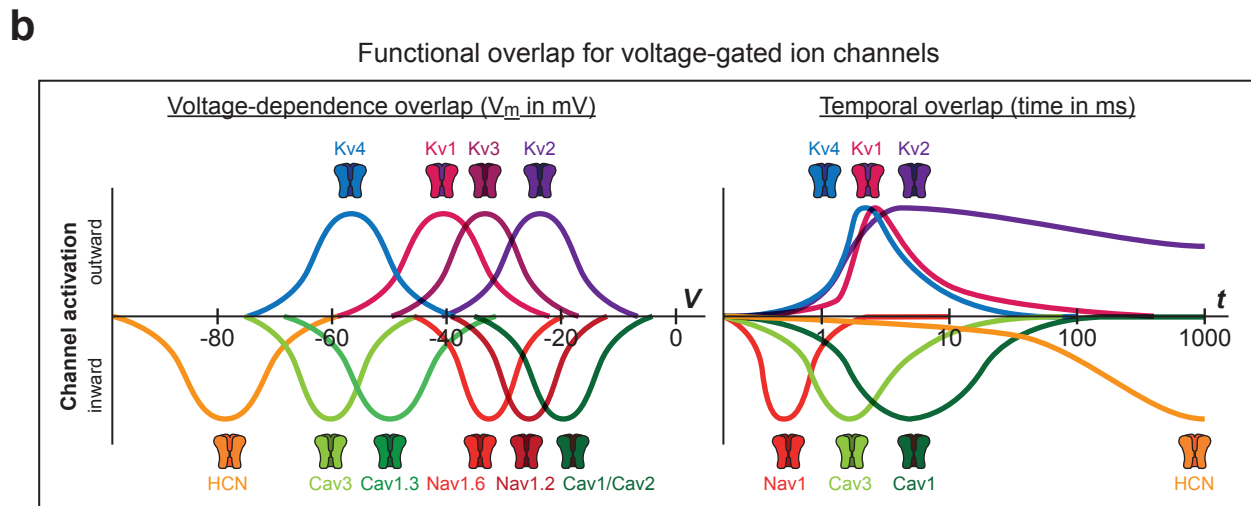
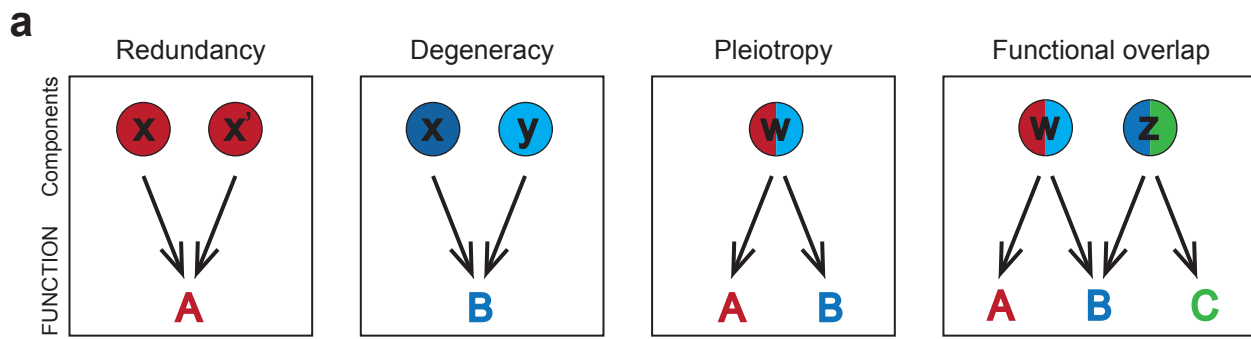
**Figure 4. Degeneracy, robustness, and variability of neuromodulation. a**, multiple ion channels targeted by one neuromodulator. The ion channels targeted by dopamine action in 6 types of pyloric neurons from the STG (AB, PD, LP, PY, VD, IC).. Inhibitory and potentiating effects are depicted as red and green arrows, respectively. In each cell type, at least two ion channels are affected in a synergistic manner (e.g. inhibition of a depolarizing current and potentiation of a hyperpolarizing current). Redrawn from Harris-Warrick and Johnson (2010). **b**, Action of a modulator can be restricted to its cellular target or spread through the network. . The neuromodulator acts on a hub neuron (hn) at the center of a network composed of Morris-Lecar models of fast (f1, f2) and slow (s1, s2) oscillators connected by electrical (resistor symbol) and chemical synapses (line and circle). The neuromodulator changes the burst amplitude

and duration in the hub neuron (top trace). Depending on the strength of the electrical and chemical synapses in the network, the effect of the neuromodulator is restricted to the hub neuron (middle traces) or percolates through the entire network (lower traces). The bursting frequencies of the 5 network neurons are represented as concentric circles and squares (f1, f2, hn, s1,s2 from outside to innermost). The two circuit models have similar control activity patterns but their responses to neuromodulation are qualitatively different. Scale bars: **b**, 120mV, 1s, horizontal tick bars indicate 0mV. Modified from Gutierrez and Marder (Gutierrez & Marder 2014).

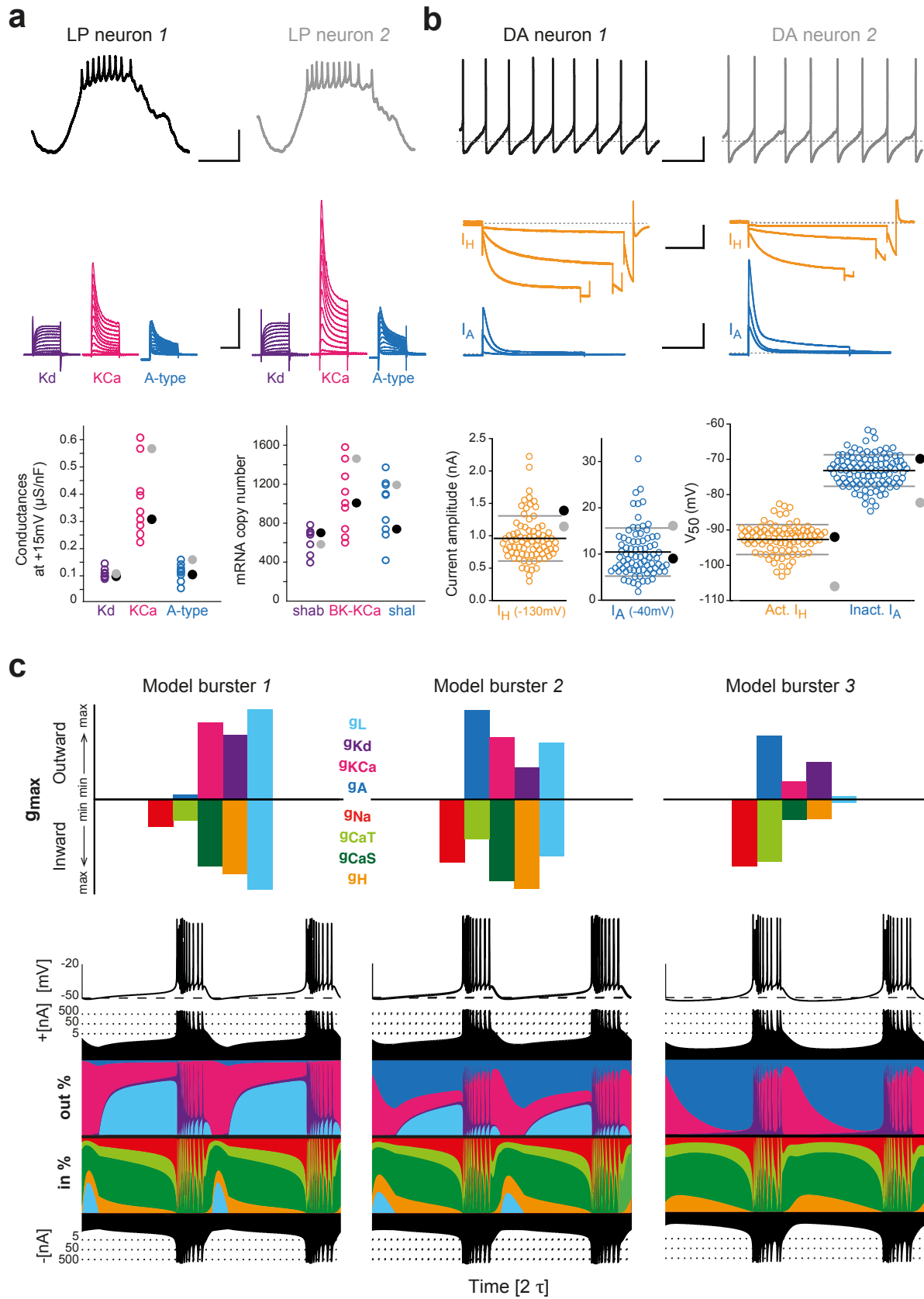
**Figure 5. Covariation in ion channel expression.** **a**, High-order correlations in ion channel expression in stomatogastric pyloric neurons. 4-D scatter plots representing the correlated levels of expression of BKKCa, I<sub>H</sub>, shal and para in the PD neurons left and of I<sub>H</sub>, shal, shaw and shab in the LP neurons (right). Modified from Schulz et al (2007). **b**, Scaffold representation of the significant correlations in ion channel expression levels for the PD neurons (top) and the LP neurons (bottom) based on Pearson analysis. As not all ion channels were measured from the same neurons, some of the correlation values were not available (grey dotted lines). The absence of a line between two nodes means that the two ion channels were measured and were not significantly correlated. **c**, High-order correlations in gene expression levels in mouse substantia nigra DA neurons. 4-D scatter plots representing the strong correlations shared by ion channel genes (Nav1.2, Kv4.3, GIRK2) and genes involved in DA metabolism and signaling (DAT, Th, D2R). Modified from Tapia et al (2018). **d**, Scaffold representation of the most significant covariations in gene expression levels identified in

substantia nigra DA neurons using bi-variate mutual information analysis. Modified from Tapia et al (2018). **e**, Pairwise correlations in ion channel expression in fast-spiking vestibular nucleus neurons. Left, 14 ion channels were quantified in 5 sub-populations of fast-spiking neurons (preoculomotor, pre-cerebellar, commissural, cerebellar target, local interneuron) and all pairwise correlations (91, scatter plots on the left, Pearson analysis) were tested on the pooled samples. Significant correlations ( $r > 0.4$ ) are indicated by colored regression lines. Right, scaffold representation of the significant correlations in ion channel expression identified in fast-spiking vestibular nucleus neurons. Modified from Kodama et al (2020).

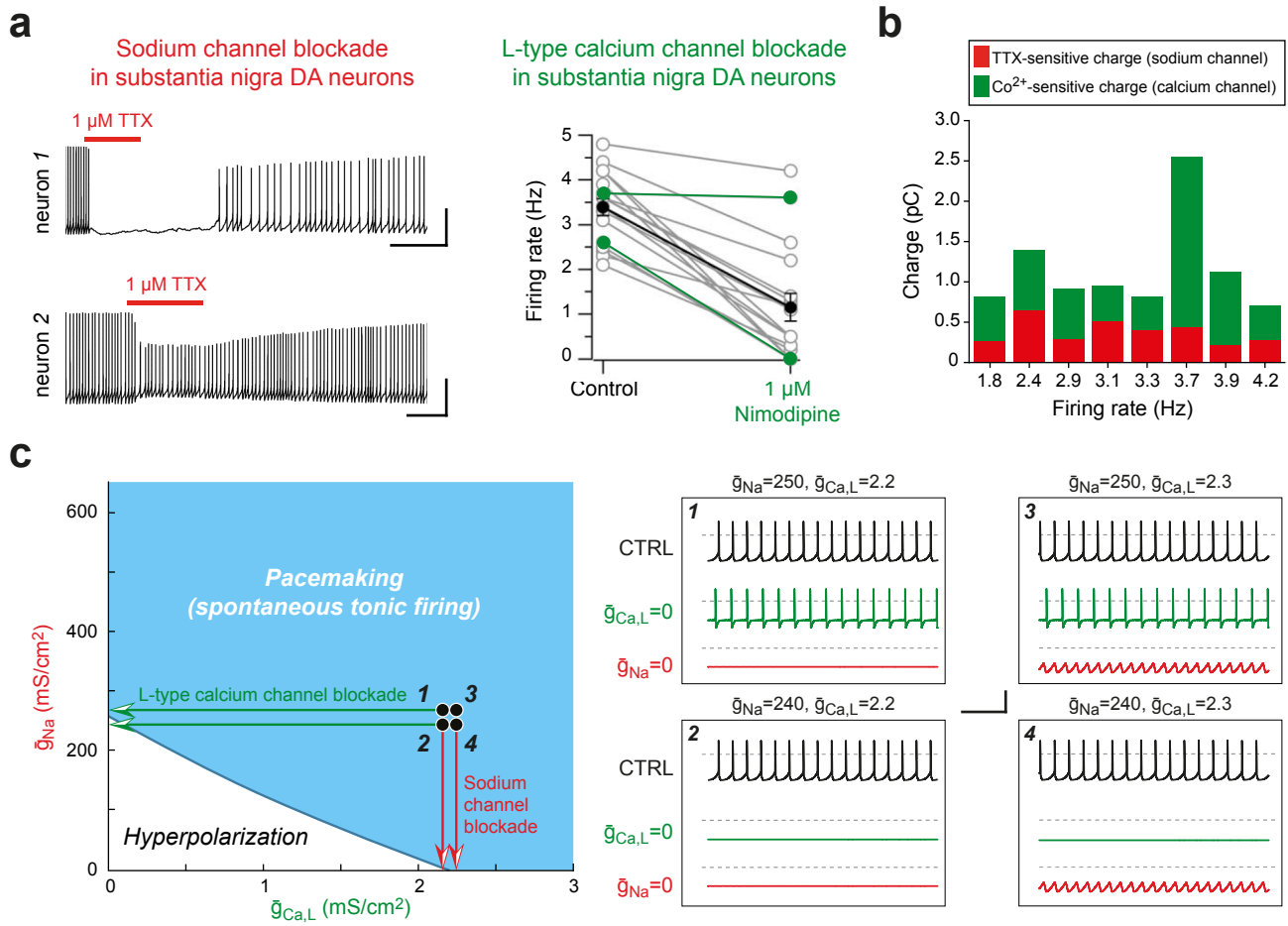
**Figure 6. Rethinking cell identity and electrical phenotype.** Two populations of anatomically- and/or functionally-related neurons (green and blue dots) are represented in the two-dimensional space corresponding to the levels of expression/conductance of two ion channels. The colored clouds delimit the regions of parameter space corresponding to specific firing phenotypes, the green and blue clouds corresponding to the control phenotypes of the two neuronal populations considered. The phenotype is not quantitatively constant within each cloud, and the two populations of neurons have qualitatively similar but quantitatively different phenotypes.



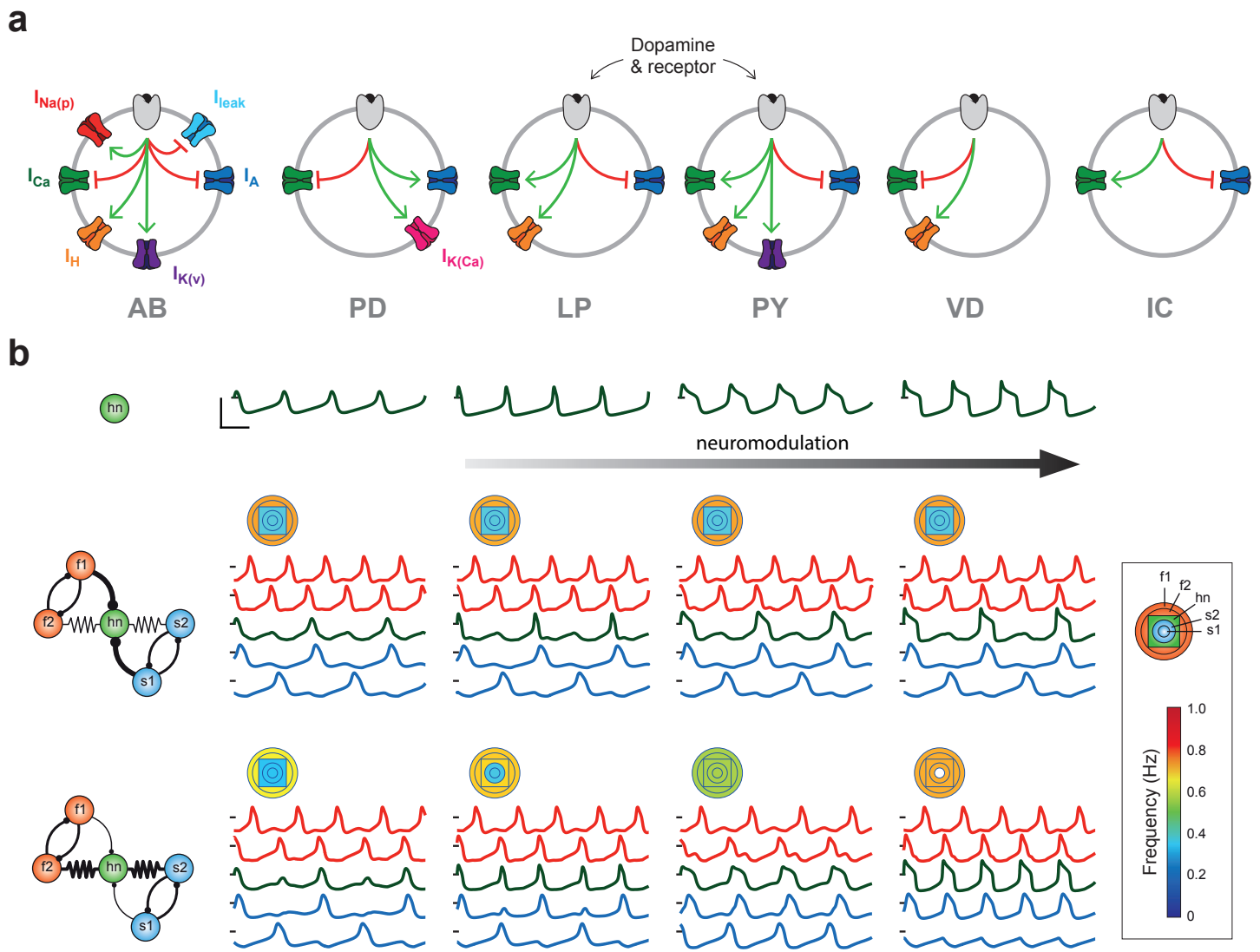
**FIGURE 1**



**FIGURE 2**

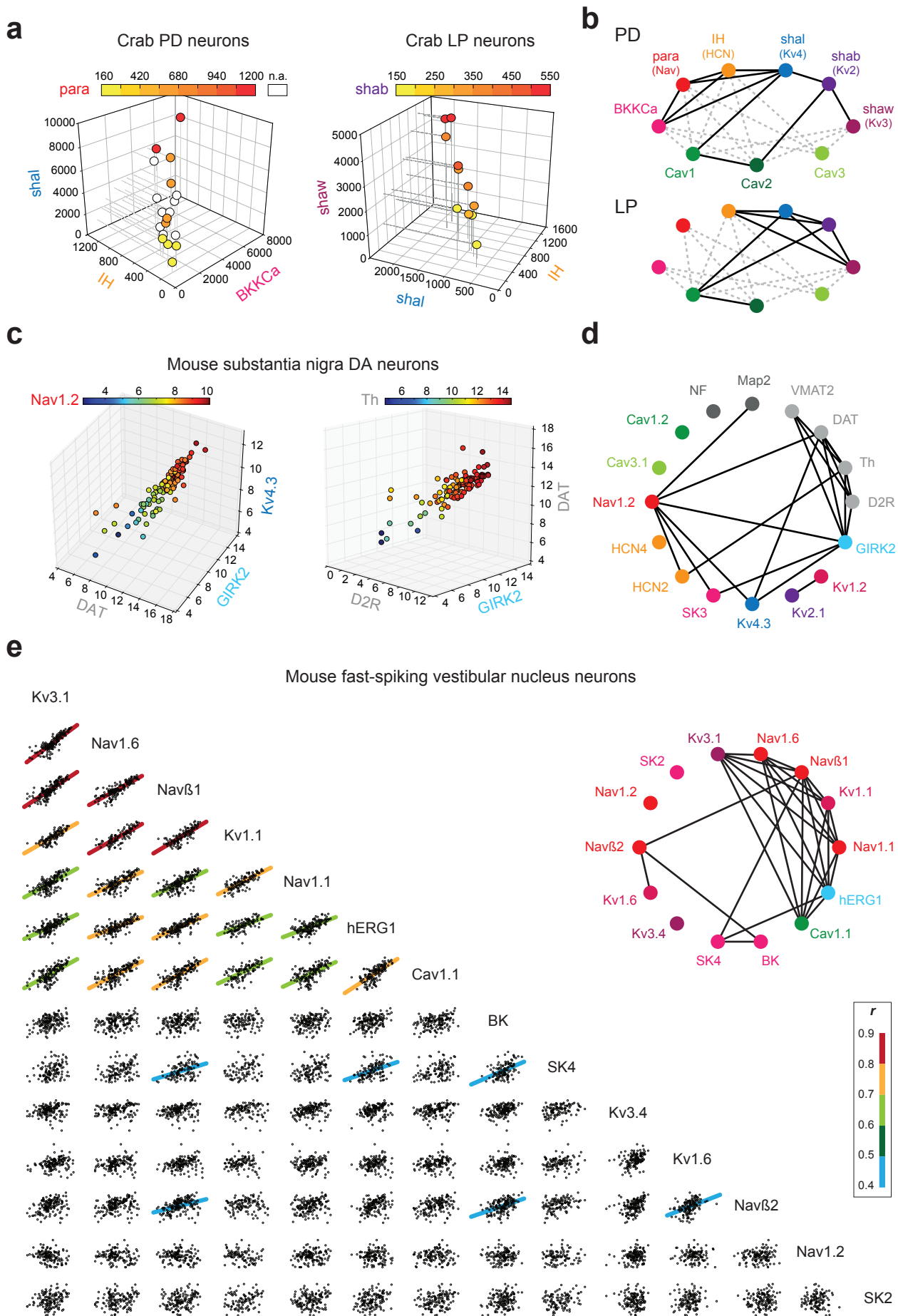


**FIGURE 3**



**FIGURE 4**





**FIGURE 5**

**a.** The high-dimensional parameter space of conductances (simplified here to 2 ion channels) is structured by covariations in expression/conductance of ion channels.

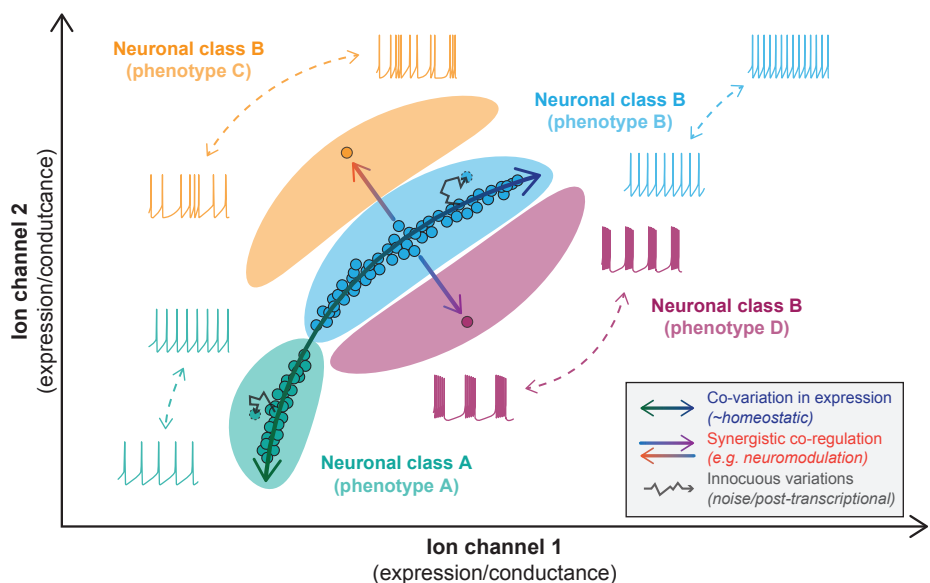
**b.** Covariations may be linear or non-linear (preventing the use of arithmetic means to characterize the cell type).

**c.** Anatomically- and/or functionally-related cell types may be organized in a continuum rather than in discrete clusters, and may share covariations of ion channels.

**d.** Substantial variability in electrical phenotype is expected within the same neuronal type.

**e.** Modulation of electrical phenotype may result from synergistic co-regulation of conductances in directions orthogonal to the cell type-specific covariations in ion channel function.

**f.** The regions of parameter space corresponding to a phenotype are larger than the regions defined by the covariations of ion channels, allowing substantial variability without disruption of the target phenotype (innocuous variations).



**FIGURE 6**