



HAL
open science

Development of backing piezoelectric micromachined ultrasonic transducer (B-PMUT) 2D array

Xu-Bo Wang, You-Cao Ma, Le-Ming He, Yan Wang, Wei-Jiang Xu, Antoine Riaud, Jun-Yan Ren, Jia Zhou

► **To cite this version:**

Xu-Bo Wang, You-Cao Ma, Le-Ming He, Yan Wang, Wei-Jiang Xu, et al.. Development of backing piezoelectric micromachined ultrasonic transducer (B-PMUT) 2D array. 2021 IEEE International Ultrasonics Symposium (IUS), Sep 2021, Xi'an, China. pp.1-4, 10.1109/IUS52206.2021.9593679 . hal-03540999

HAL Id: hal-03540999

<https://hal.science/hal-03540999v1>

Submitted on 16 Aug 2022

HAL is a multi-disciplinary open access archive for the deposit and dissemination of scientific research documents, whether they are published or not. The documents may come from teaching and research institutions in France or abroad, or from public or private research centers.

L'archive ouverte pluridisciplinaire **HAL**, est destinée au dépôt et à la diffusion de documents scientifiques de niveau recherche, publiés ou non, émanant des établissements d'enseignement et de recherche français ou étrangers, des laboratoires publics ou privés.

Development of backing piezoelectric micromachined ultrasonic transducer (B-PMUT) 2D array

Xu-bo Wang¹, You-cao Ma¹, Le-ming He^{1,2}, Yan Wang¹, Wei-jiang Xu^{2,3}, Antoine Riaud¹, Jun-yan Ren¹, Jia Zhou^{1*}

¹ State Key Laboratory of ASIC and System, School of Microelectronics, Fudan University, Shanghai, P. R. China

² Université Polytechnique Hauts-de-France, CNRS, Univ. Lille, Centrale Lille, UMR 8520-IEMN, DOAE, F-59313 Valenciennes, France

³ INSA Hauts-de-France, Le Mont Houy, F-59313 Valenciennes, France

*E-mail: jia.zhou@fudan.edu.cn

Abstract— To improve the problem of narrow bandwidth and large crosstalk in high-frequency PMUT array, a PMUT device with a damping backing structure (B-PMUT) is proposed and realized. The device is a two-dimensional array of 8×16 elements with an element pitch of 75 μm. The results show that the bandwidth of the device with backing is more than doubled (63%) to that of without backing. The crosstalk level between two neighboring elements decreased from -13.4 dB to -17 dB.

Keywords— *pMUTs, 2D array, PDMS, Backing, Crosstalk*

I. INTRODUCTION

Ultrasonic imaging is a cost-effective and harmless detection method [1], where ultrasonic array transducers are the key components [2-4].

Traditionally, most ultrasonic transducers are fabricated with bulk piezoelectric materials using the machining process[5]. Compared with these transducers, the micromachined ultrasonic transducers (MUTs) are fabricated based on micromachining technology. These kinds of devices are easy to realize in high working frequencies (over 10 MHz)[6], can be produced in batch, and most can be designed and fabricated with application-specific integrated circuit (ASIC) on the same wafer[7]. Therefore, MUTs are promising to realize high-performance transducers with small device sizes.

PMUT is actuated by piezoelectric thin film[8]. Like bulk ultrasonic transducers, the imaging performance of PMUT depends on the bandwidth which affects the axial resolution of the image, and the crosstalk which determines the accuracy and the flexibility of beam control in the imaging[9, 10].

To obtain high bandwidth performance, series cells with different center frequencies are used[11]. The disadvantage of the method is that the active surface of the array cells should be large, which makes a small array pitch of high-frequency transducers.

For crosstalk reduction, array structure optimization by numerical simulation, usually with finite element method, and analysis are necessary[12-15]. There is a lack of experimental studies and test results for 2D array PMUT[16].

To solve the above problems, in this work, a PMUT device with a PDMS backing structure is designed and fabricated. Based on the Laser Doppler vibrometer (LDV) testing results, the bandwidth and crosstalk characteristics of the device with and without backing are compared and analyzed to show better performance in the first case.

II. METHODS

A. Design and Fabrication

The generation and reception of acoustic waves in a PMUT are based on the vibration of a thin membrane clamped

on a supporting substrate [17, 18]. One side of the membrane will be charged with a transmitting medium (load) and another side is usually contact-free with a cavity between the membrane and the substrate. This configuration leads to a narrow bandwidth of the vibration and higher acoustic crosstalk between array elements. To optimize the bandwidth and crosstalk characteristics of the PMUT, in this paper, a PMUT with a filled cavity (using PDMS as damping material) is proposed.

The designed backing PMUT (B-PMUT) element is shown in Fig. 1(a). The element consists of a PZT island layer on a vibrating membrane in Si, the PTZ layer being in sandwich with two electrodes, and a back cavity filled with a damping material (PDMS), which makes the B-PMUT different from the conventional PMUT (C-PMUT) device. The depth of the backing structure is 330 μm ($d_1=300$ μm, $d_2=30$ μm). The array structure is shown in Fig. 1(b), including 16×8 elements that can be independently and electrically controlled. The array element has a pitch of 75 μm. Other processing details and structural parameters of the device can be referred to in the references [19].

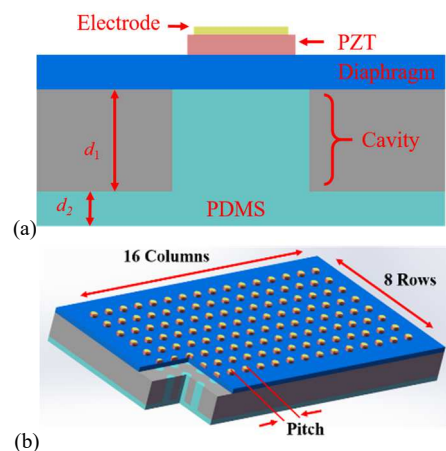

Fig. 1. Schematic of B-PMUT. (a) The designed structure of a single element. (b) Three-dimensional (3D) schematic of the array.

As shown in Fig. 2, the left is the C-PMUT element profile, the right is the backing PMUT element section, the PDMS backing structure is noted with a red dash line box. The PDMS material is perfectly filled in the cavity and joints closely with the vibration membrane, no obvious bubbles exist, which meet the design expectations.

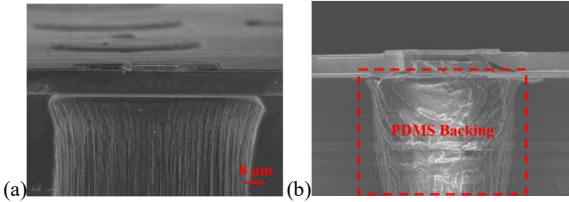

Fig. 2. Cross-sectional SEM image of (a) C-PMUT and (b) B-PMUT.

B. Experimental measurement

To obtain the acoustical characteristics of the device, a LDV test platform is built and is shown in Fig. 3. For the test, a wideband pulse signal, generated by an AFG, then amplified by a power amplifier, is applied to one element of the PMUT array. The vibration response at the center of the element surface is measured.

To get the bandwidth response of the array element, the element under test is generally selected on the central region far from the edge of the device, as shown in Fig. 4 (a).

The crosstalk characteristics of the device are determined with a 3×3 submatrix of the array, as shown in Fig. 4 (b). The central element (in red) is electrically excited with a wideband pulse. The displacement responses of the center element, the four elements closest to the central one (the adjacent units in blue), and four elements farther away from the central one (diagonally sub-adjacent units in green) are monitored respectively using the LDV. Finally, the time domain signal is converted into the frequency domain spectrum and analyzed.

To demonstrate the effect of backing on the bandwidth and crosstalk performance, the device before backing (C-PMU) and after backing (B-PMUT) are tested. The source of crosstalk includes usually electric and acoustic ones. To observe electrical crosstalk separately, we first destroyed the PZT film of the vibration element by using a high input voltage. The element was then excited with an excitation

signal and verified by LDV that there is no mechanical vibrate. The voltage at one of the adjacent element is then measured directly by an oscilloscope. The level of electrical crosstalk between the two cells can be obtained by comparing the electric signal on the reception cell with that on the excitation one. The level of electric crosstalk is close to -40 dB, that is to say, the electrode formed by micromachining technology has good electrical isolation performance. To determine the transmission mode of acoustic crosstalk between elements, the frequency response characteristics and crosstalk level of two kinds of devices are tested under air load and water load respectively.

III. RESULTS AND DISCUSSION

Fig. 5(a) shows the crosstalk response of the C-PMUT device with air load. The red line represents the response of the central element in the frequency domain, and the blue and green lines represent the response of the first and second adjacent elements, respectively. In this case, the crosstalk between elements is serious, the level of the first adjacent element is the largest, reaching -4.5 dB (difference between the red spectrum and the blue spectrum).

When the device is water-loaded, the crosstalk level with the same excitation condition is shown in Fig. 5(b). The maximum crosstalk occurs on the first adjacent unit, and it decreases to -13.4 dB.

Fig. 5(c) gives the crosstalk response of the B-PMUT device in air. The maximum crosstalk level between elements still occurs at the first adjacent element, which is -30 dB.

Fig. 5(d) is the crosstalk level of the B-PMUT device under the condition of water load. The first adjacent unit has the largest crosstalk level of -17dB.

The results for the device under two load and back conditions can be classified into four quadrants, as shown in Fig. 6. In the case of load-free and backing-free (third quadrant in yellow background), the device operates in a narrow band,

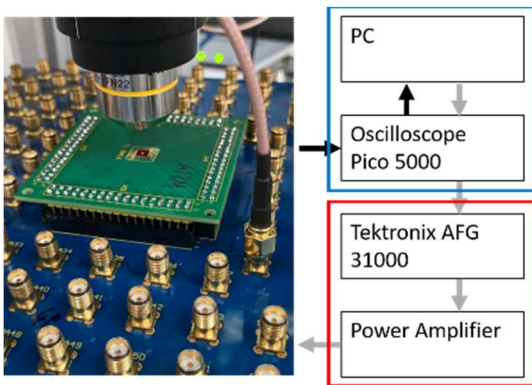

Fig. 3. LDV setup for characterizing the PMUT performance.

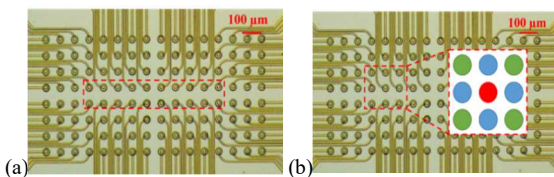
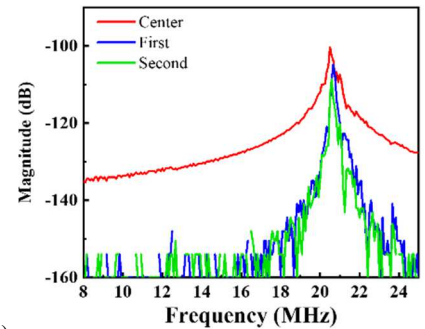
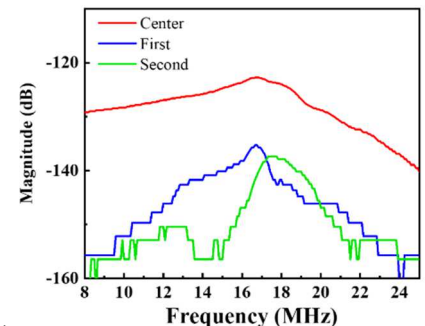

Fig. 4. The element under test. (a) The elements in the center region of the array. (b) One of the 3×3 submatrix for crosstalk test.



(a)



(b)

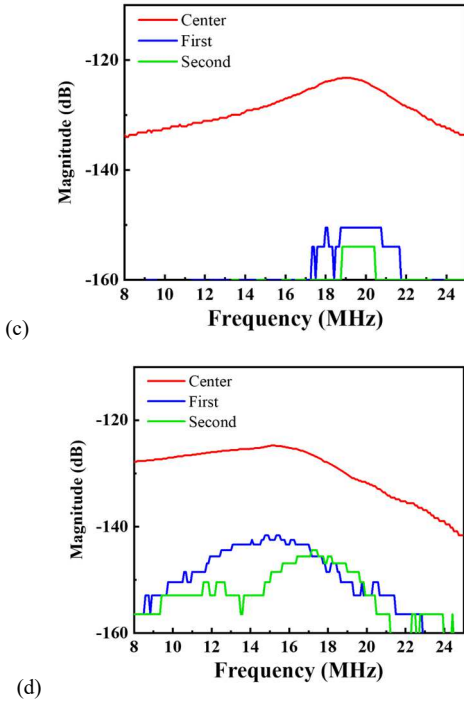

Fig. 5. The crosstalk response of the C-PMUT and B-PMUT under air and water load respectively. (a) The response of C-PMUT with air load. (b) The response of C-PMUT with water load. (c) The response of B-PMUT with air load. (d) The response of B-PMUT with water load.

i.e. low energy loss during the vibration period. In this case,

Only Loading No Backing -13.4 dB 27.8%	Loading and Backing -17 dB 63%
No Loading No backing -4.5 dB 2.8%	No Loading Only Backing -30 dB 15%

Fig. 6. The comparison of the fractional bandwidth and crosstalk between C-PMUT and B-PMUT.

there is maximum crosstalk between elements. Because: when there is no surrounding medium contacted to the vibrating membrane (loading or backing), the energy transmission will take place only between the array elements of the PMUT in the form of structural coupling with small loss, and thus cause large crosstalk.

Generally, when the PMUT is loaded or backed, the bandwidth of the device will be enlarged, while the crosstalk level is reduced. This is shown in the second and fourth quadrants (with blue background). This can be contributed to the energy loss ratio in the vibration cycle that is increased.

The first quadrant represents the backing structure (B-PMUT), which has a bandwidth of up to 63% and smaller crosstalk (-17 dB). Comparing with the second quadrant, adding backing can double the bandwidth and decrease the crosstalk level by about 3.6 dB, respectively. This is because the backing works as extra damping of the PMUT with the loading.

However, Comparing with the fourth quadrant, loading can increase the bandwidth fourfold and increase the crosstalk level about 13 dB, simultaneously. We believe, at this time, the main crosstalk energy transmission path is in the loading medium, and the level of the crosstalk will be related to the properties of the medium and array pitch.

IV. CONCLUSION

To optimize the bandwidth and crosstalk of PMUT array devices, a PMUT with backing (B-PMUT) is designed and fabricated. Both the bandwidth and crosstalk of the device can be effectively improved when the backing is added. However, the crosstalk energy propagating through the loading medium cannot be effectively decreased by increasing the backing. At this time, the level of the crosstalk is mainly related to the properties of the medium with a certain structure dimension.

V. ACKNOWLEDGMENT

This work was supported by the National Natural Science Foundation of China with Grant No. 51950410582 and No. 61674043, 12004078.

REFERENCES

- [1] MILLER D L, SMITH N B, BAILEY M R, et al. Overview of Therapeutic Ultrasound Applications and Safety Considerations[J]. Journal of Ultrasound in Medicine, 2012, 31 (4): 623-634.
- [2] WANG J, ZHENG Z, CHAN J, et al. Capacitive micromachined ultrasound transducers for intravascular ultrasound imaging[J]. Microsystems Nanoengineering, 2020, 6 (1): 73.
- [3] JIANG X, TANG H Y, LU Y, et al. Ultrasonic Fingerprint Sensor With Transmit Beamforming Based on a PMUT Array Bonded to CMOS Circuitry[J]. IEEE Transactions on Ultrasonics Ferroelectrics Frequency Control, 2017, PP (9): 1-1.
- [4] CHEN X, XU J, CHEN H, et al. High-Accuracy Ultrasonic Rangefinders via pMUTs Arrays Using Multi-Frequency Continuous Waves[J]. Microelectromechanical Systems, 2019.
- [5] CABRERA-MUNOZ N E, ELIAHOO P, WODNICKI R, et al. Fabrication and Characterization of a Miniaturized 15-MHz Side-Looking Phased-Array Transducer Catheter[J]. IEEE Transactions on Ultrasonics Ferroelectrics and Frequency Control, 2019: 1-1.
- [6] LU Y, HEIDARI A, SHELTON S, et al. High frequency piezoelectric micromachined ultrasonic transducer array for intravascular ultrasound imaging[S]. IEEE International Conference on Micro Electro Mechanical Systems; 2014.
- [7] ZAMORA I, LEDESMA E, URANGA A, et al. Monolithic single PMUT-on-CMOS ultrasound system with +17 dB SNR for Imaging Applications[J]. IEEE Access, 2020, PP (99): 1-1.
- [8] JUNG J, LEE W, KANG W, et al. Review of piezoelectric micromachined ultrasonic transducers and their applications[J]. Journal of Micromechanics and Microengineering, 2017, 27 (11): 113001.
- [9] BERG S, RONNEKLEIV A. 5F-5 Reducing Fluid Coupled Crosstalk Between Membranes in CMUT Arrays by Introducing a Lossy Top Layer[S]. Ultrasonics Symposium; 2012.
- [10] LARSON J D. Non-Ideal Radiators in Phased Array Transducers[S]. IEEE; 1981.
- [11] NISTORICA C, LATEV D, SANO T, et al. High Frequency Piezoelectric Micromachined Transducers with Wide Bandwidth and High Sensitivity[S]. 2019 IEEE International Ultrasonics Symposium (IUS); 2019: 1088-1091.
- [12] HE L M, XU W J, LIU W J, et al. Performance and Crosstalk Evaluation of 2-D Array Piezoelectric Micromachined Ultrasonic Transducer with 3-D Finite Element Simulation[S]. 2019 IEEE International Ultrasonics Symposium (IUS); 2019.
- [13] PIROUZ A, MAGRUDER R, HARVEY G, et al. Crosstalk Study of Large PMUT Array using FEA and Cloud HPC[S]. 2019 IEEE International Ultrasonics Symposium (IUS); 2019.
- [14] DZIEWIERZ J, RAMADAS S N, GACHAGAN A, et al. A 2D Ultrasonic array design incorporating hexagonal-shaped elements and triangular-cut piezocomposite substructure for NDE applications[S]. Ultrasonics Symposium; 2009.
- [15] XU T, ZHAO L, JIANG Z, et al. Array Design of Piezoelectric Micromachined Ultrasonic Transducers With Low-Crosstalk and High-

Emission Performance[J]. IEEE Transactions on Ultrasonics Ferroelectrics Frequency Control, 2019, PP (99): 1-1.

[16] QI W, HORSLEY D A. Using a mutual acoustic impedance model to improve the time domain response of PMUT arrays[S]. 2017 IEEE International Ultrasonics Symposium (IUS); 2017.

[17] AKASHEH F, FRASER J, BOSE S, et al. Piezoelectric micromachined ultrasonic transducers: modeling the influence of structural parameters on device performance[J]. IEEE Transactions on Ultrasonics Ferroelectrics & Frequency Control, 2005, 52 (3): 455.

[18] MURALT P, BABOROWSKI J. Micromachined Ultrasonic Transducers and Acoustic Sensors Based on Piezoelectric Thin Films[M]. Journal of Electroceramics, 2004.

[19] WANG X-B, HE L-M, MA Y-C, et al. Development of Broadband High-Frequency Piezoelectric Micromachined Ultrasonic Transducer Array[J]. Sensors, 2021, 21 (5): 1823.