

# Vaporization at high reduced pressure induced by very rapid power input

## *Dispersed two phase flow*

Jean Muller, Pierre Ruyer, Romuald Rullière, Marc Clause

12 Octobre 2021



## Context

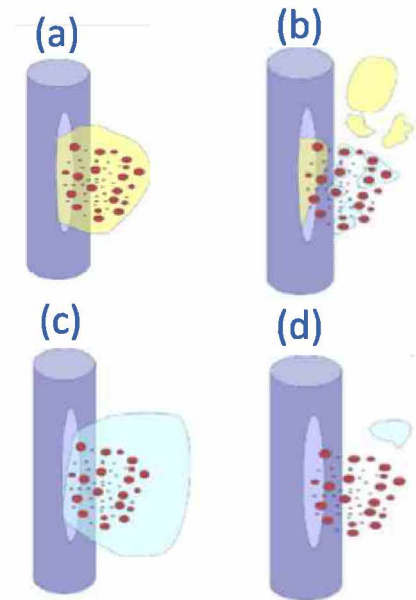
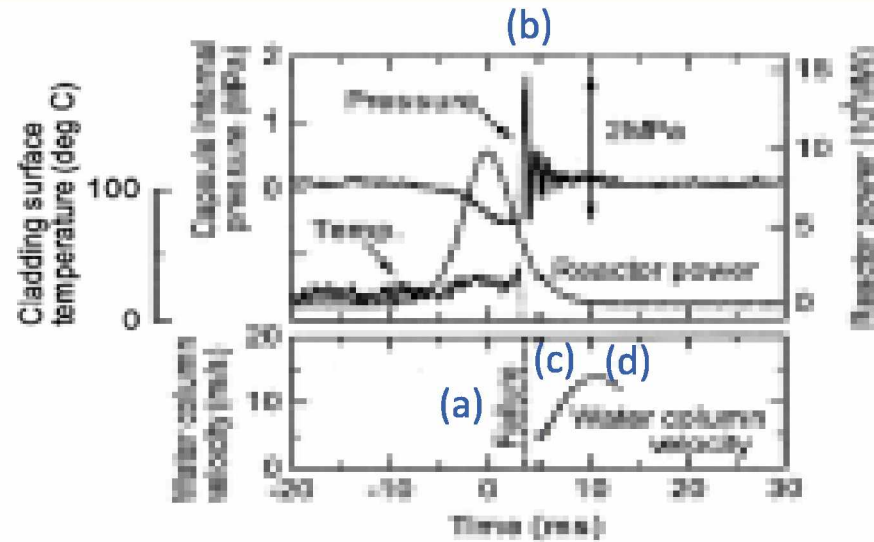
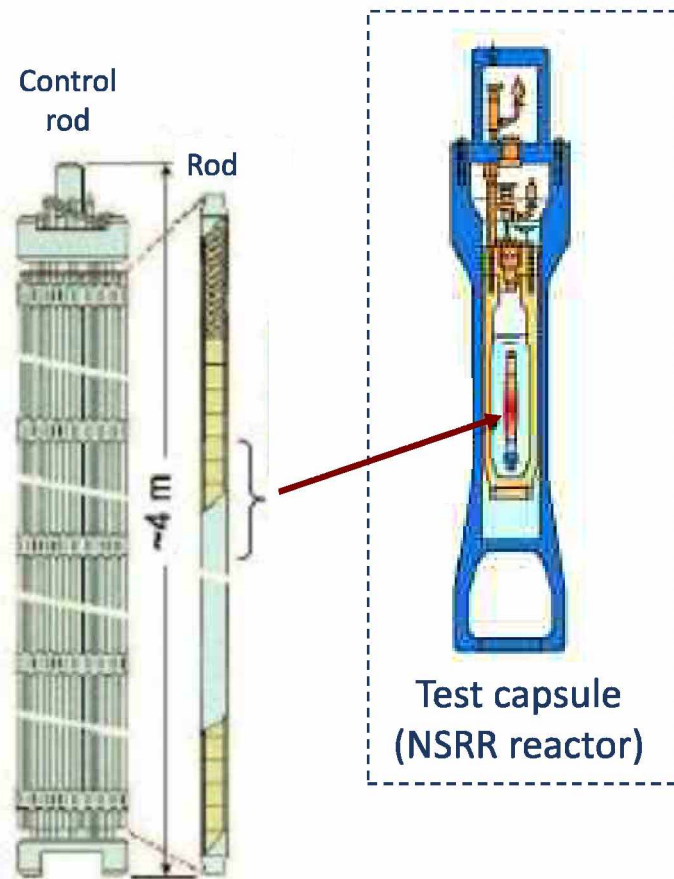

- High pressure transient (2MPa)
- Massive creation of vapour

*Atmospheric pressure and temperature*

### Main question

How the test conditions influence the thermal shock consequences ?

Results extracted from : Sugiyama, T. and Fuketa, T. (2000). Mechanical Energy Generation during High Burnup Fuel Failure under Reactivity Initiated Accident Conditions. *Journal of Nuclear Science and Technology*, 37(10) :877–886.

## ➤ I. EDITE

- Test section
- Acquisition
- Tests performed

# EDITE (Etude d'un Dépôt Intense et Transitoire d'Énergie)

Discharge 9 condensers  
Discharge: 1 kJ within 5 ms

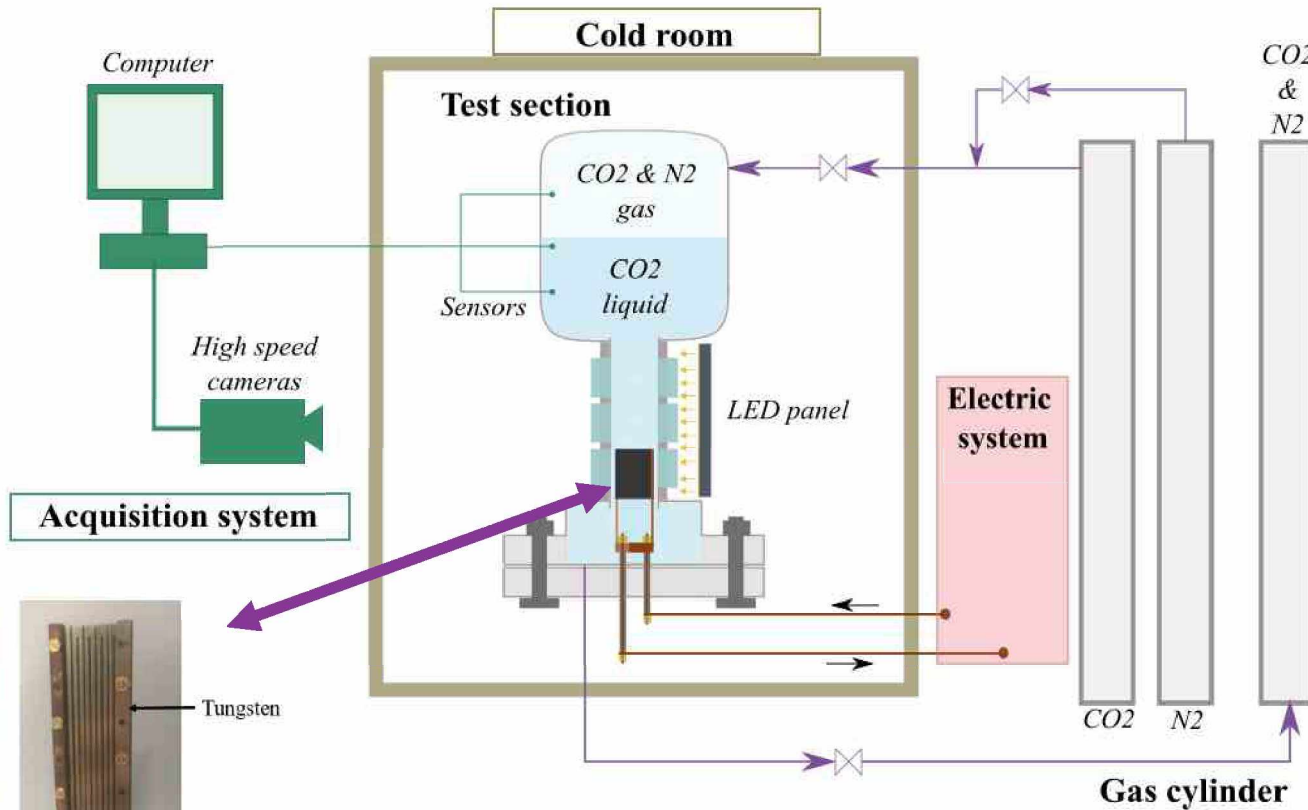

Fluid :  $CO_2$   
 $\left\{ \begin{array}{l} P \in [2,5 ; 6,2] \text{ MPa} \\ T \in [-15 ; 24] \text{ } ^\circ\text{C} \end{array} \right.$

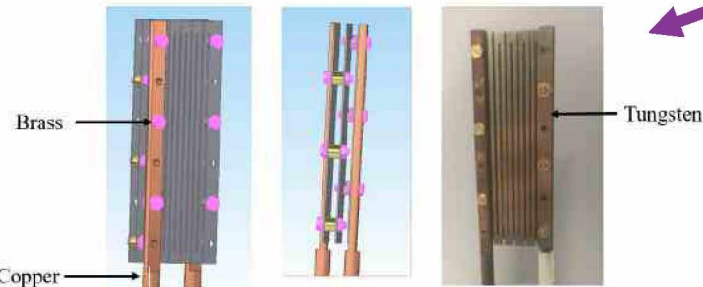

# EDITE (Etude d'un Dépôt Intense et Transitoire d'Énergie)

Temperature and static pressure  
1 Hz

Dynamic pressure ( $P_1, P_2, P_3$ ) – Voltage and Current  
500 kHz

$$(U, I) \rightarrow R_W(T) \rightarrow T_W$$

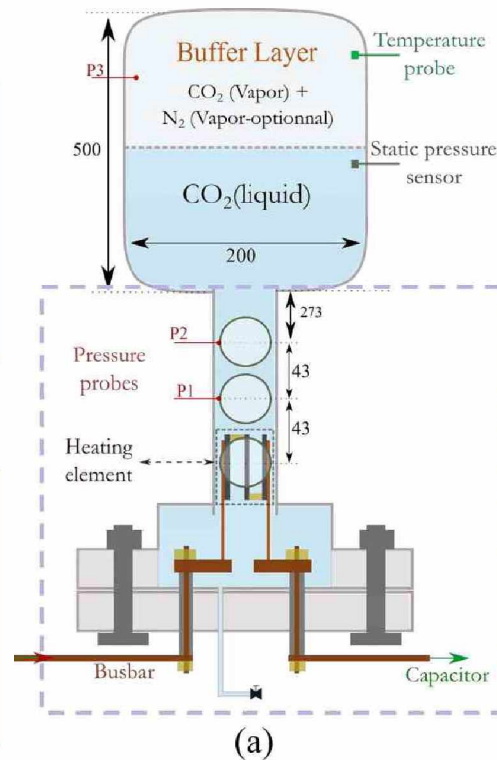

c1

c2



3 kHz  
7.63 px/mm

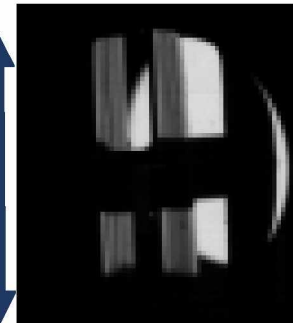

15 kHz  
9.2 px/mm

16.5 mm

# Tests performed

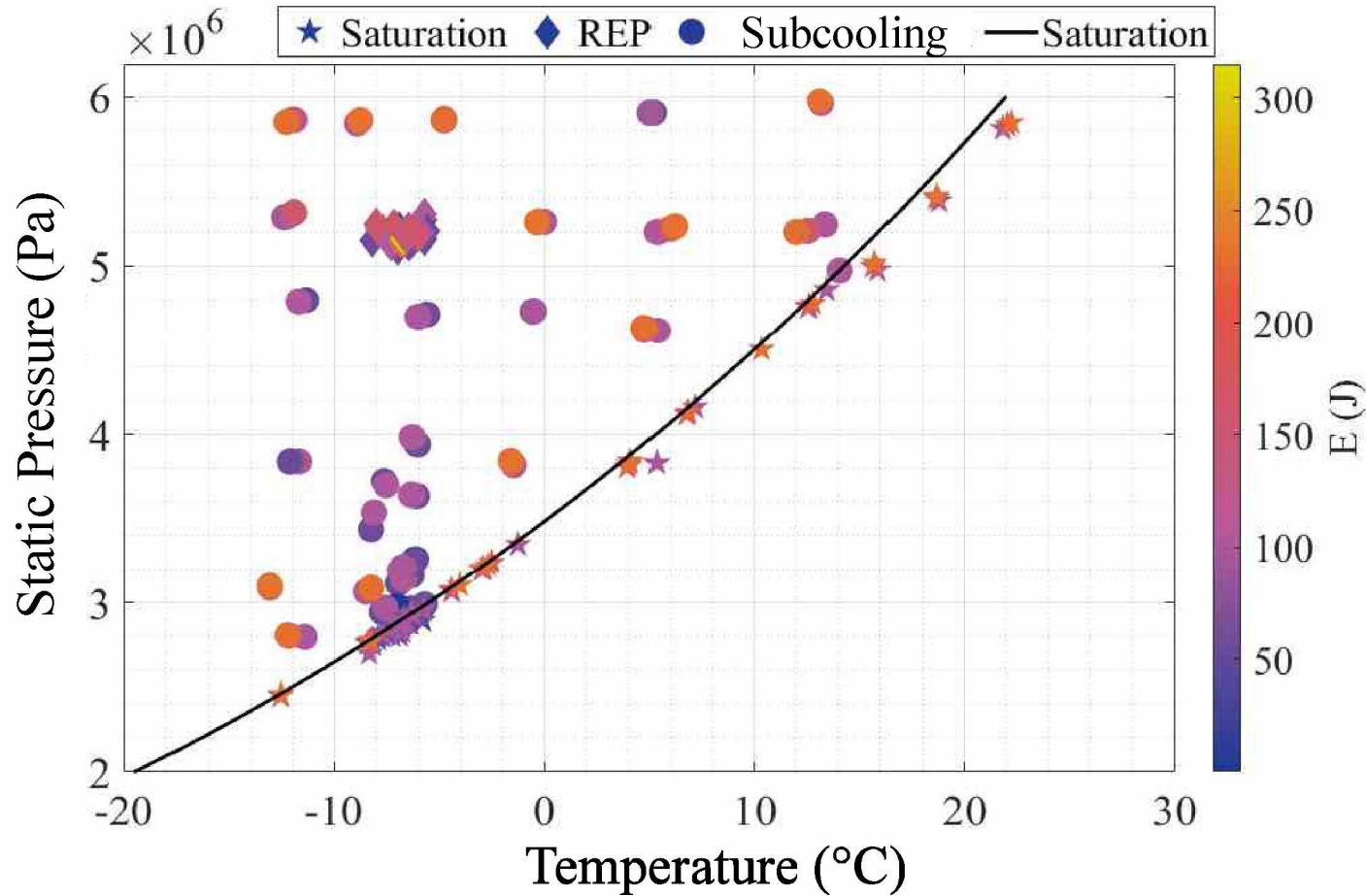

**200 tests**

$P \in [25 \text{ bar} ; 62 \text{ bar}]$

$T \in [-15 \text{ }^{\circ}\text{C} ; 24 \text{ }^{\circ}\text{C}]$

$E \in [75 \text{ J} ; 340 \text{ J}]$

# Ensemble des essais

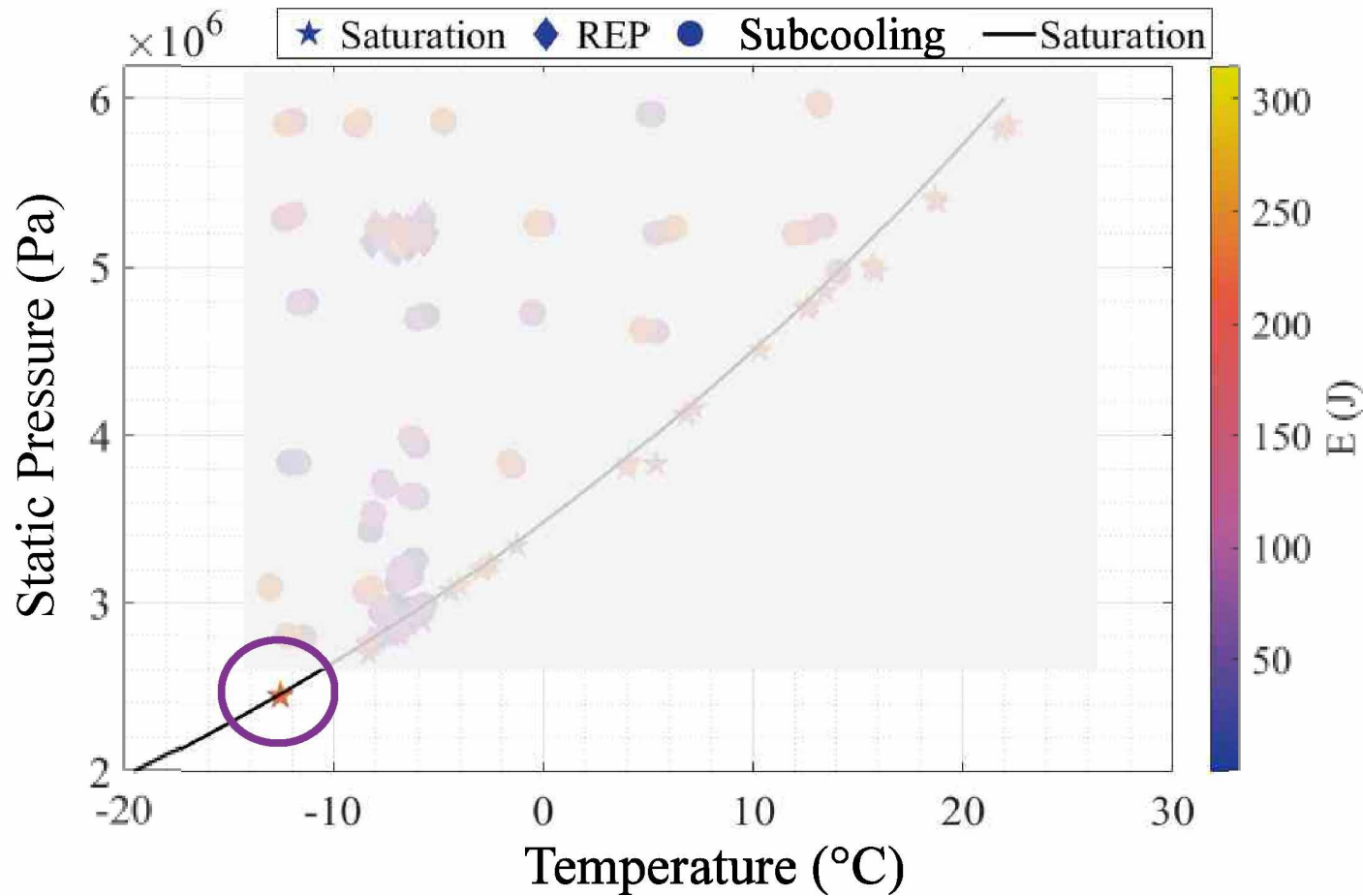

**200 tests**

$P \in [25 \text{ bar} ; 62 \text{ bar}]$   
 $T \in [-15 \text{ °C} ; 24 \text{ °C}]$   
 $E \in [75 \text{ J} ; 340 \text{ J}]$

**Test chosen**

$\left\{ \begin{array}{l} P = 25,6 \text{ bar} \\ T = -12 \text{ °C} \\ E = 240 \text{ J} \end{array} \right.$

# Test chosen

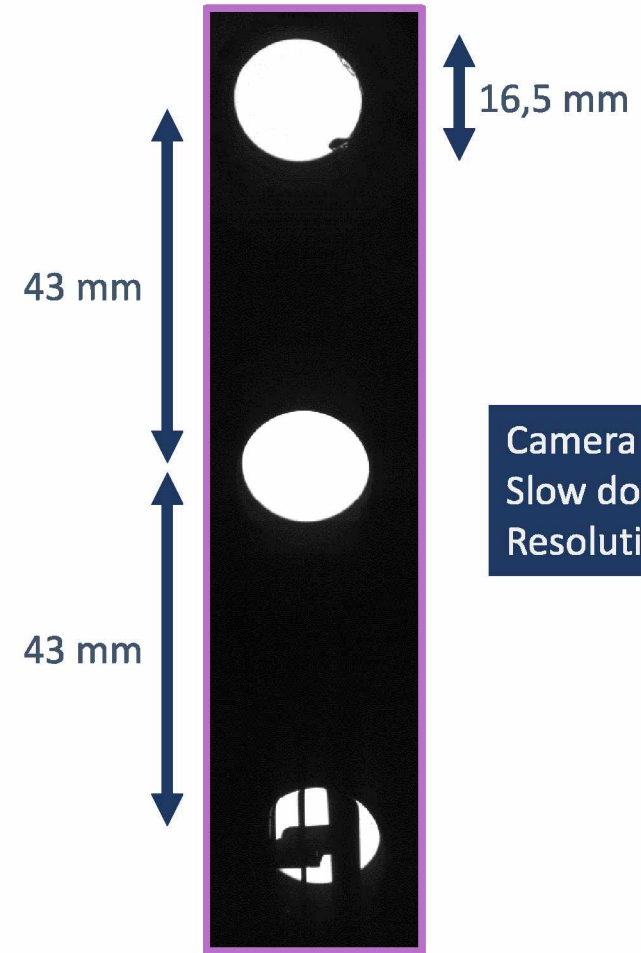
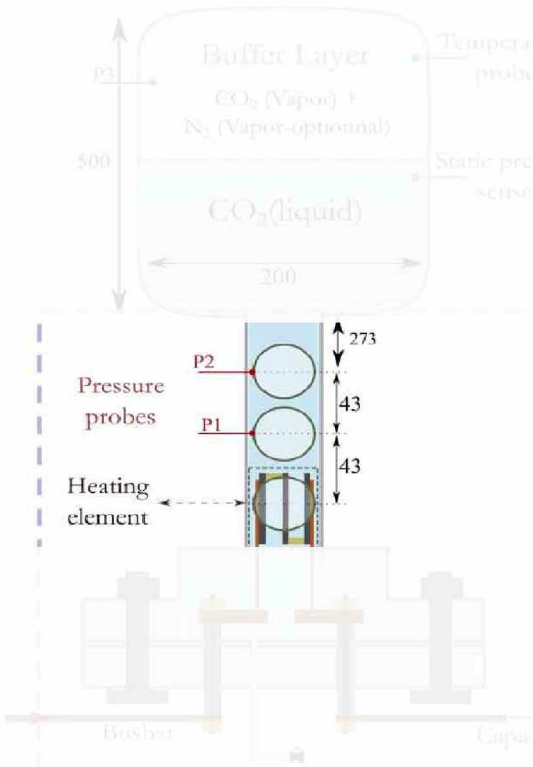

Camera 1  
Slow down : x100  
Resolution : 7.6 px/mm



## I. EDITE

- Test section
- Acquisition
- Tests performed

## ➤ II. Pressure peak

- Phenomena
- Influence of the test conditions

# Phenomena

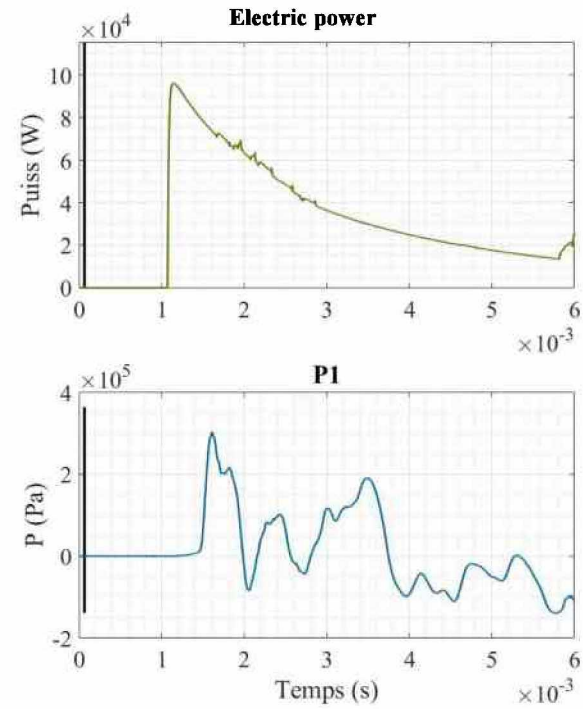
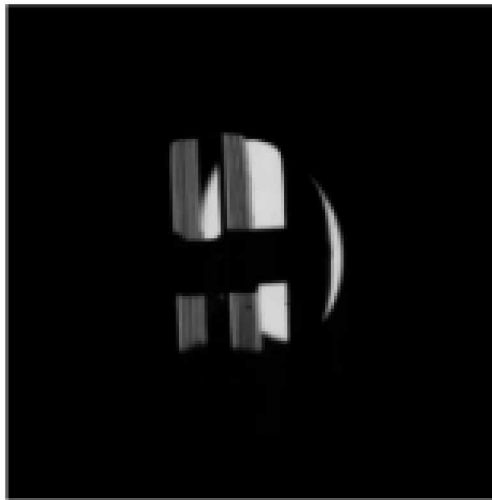

## Phénomènes

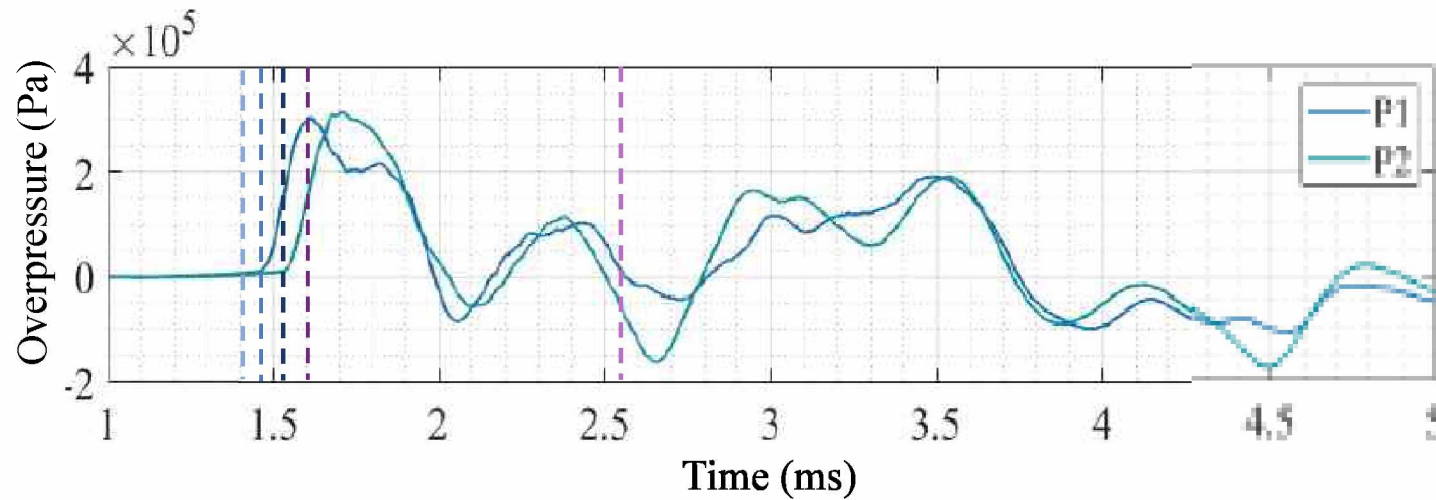
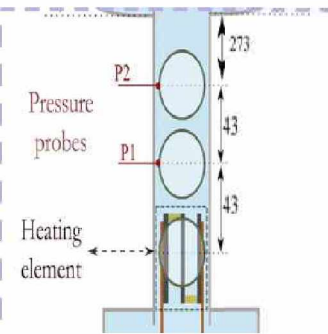

Pressure increase

 $p$  [Zhao et al.]

$$\frac{d^2 V_v}{dt^2} > 0$$

Pressure decrease  $P$ 

$$\frac{d^2 V_v}{dt^2} < 0$$

+ acoustic rebounds

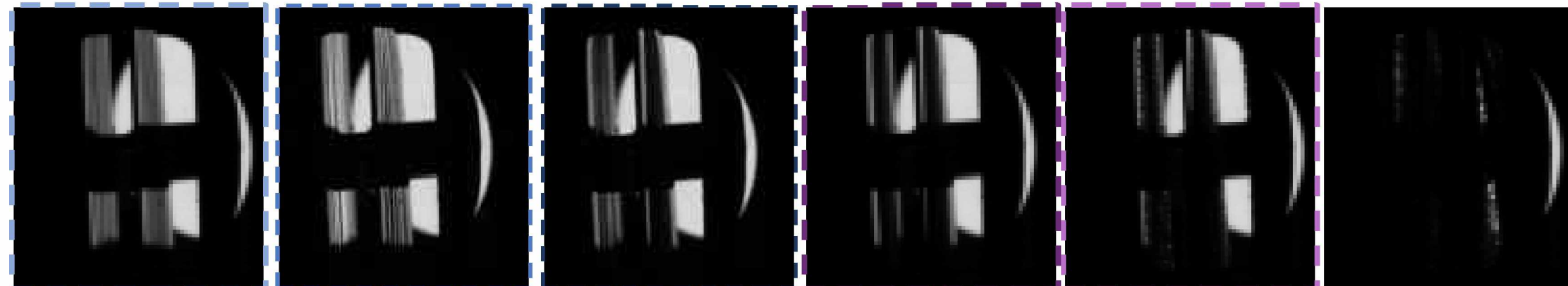

[Zhao et al.] : Zhao, Z., Glod, S., and Poulikakos, D. (2000). Pressure and power generation during explosive vaporization on a thin-<sup>®</sup>lm microheater. *Int. J. Heat Mass Transfer*, page 16.

# Influence of test conditions on the thermal shock

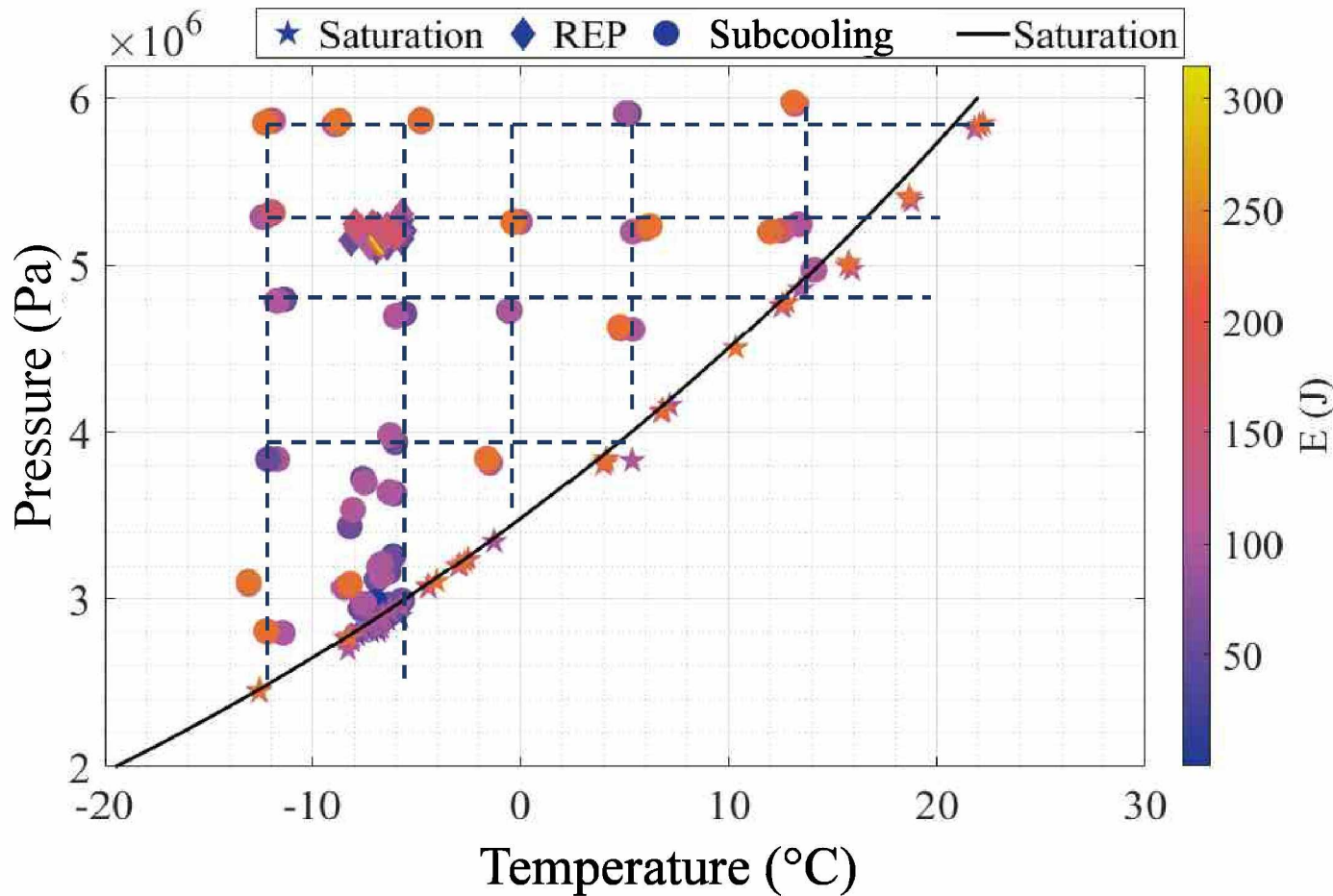

- Reduced pressure

$$P_r = P_i / P_c$$

- Theta

$$\Theta = \frac{E}{\Delta H_{i \rightarrow v}} \frac{1}{m_f}$$

- Jakob

$$Ja = \frac{\rho_l c_{p,l} (T - T_{sat}(P))}{\rho_v L(P)}$$

$$P_r = P/P_c$$

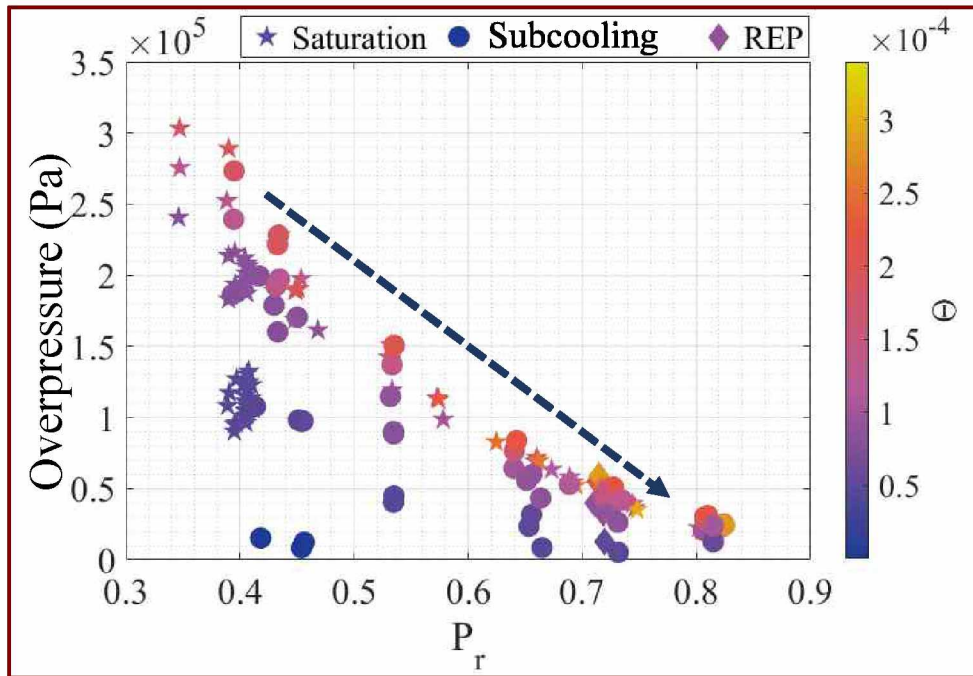

Decrease of  $P_m$  for an increasing  $P_r$

[Incertitudes en annexe](#)

$$\Theta = \frac{E}{\Delta H_{i \rightarrow v}} \frac{1}{m_f}$$

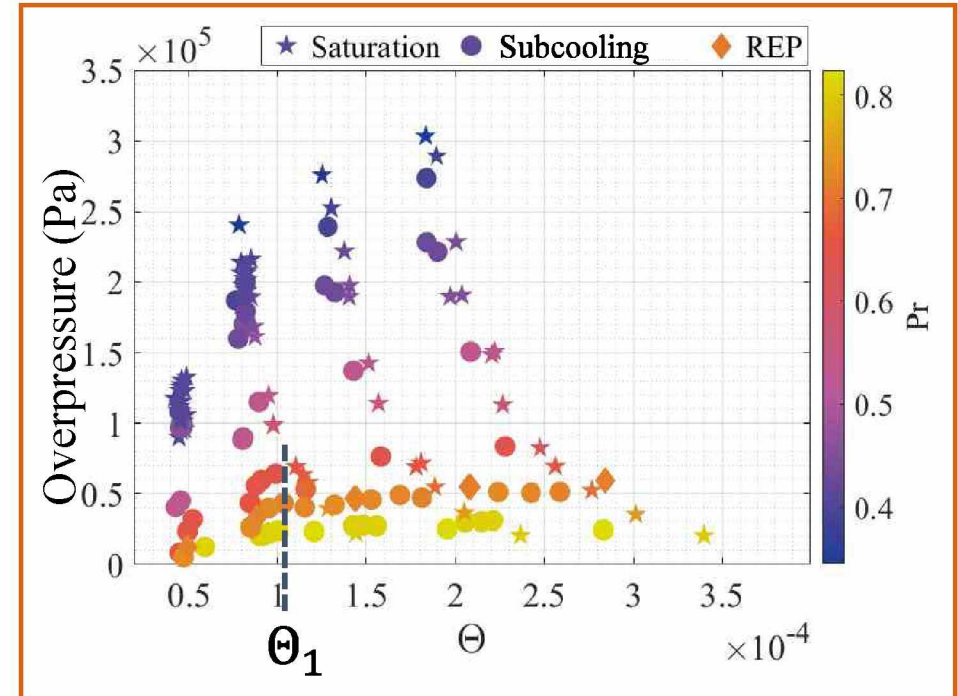

Increase of  $P_m$  with  $\Theta$  for low  $P_r$   
Saturation of  $P_m$  with  $\Theta$  for high  $P_r$

## I. EDITE

- Test section
- Acquisition
- Tests performed

## II. Pressure peak

- Phenomena
- Influence of the test conditions

## ➤ III. Vapour created

- Compression of the buffer layer
- Influence of the test conditions

# Buffer layer compression

The fluid is considered incompressible

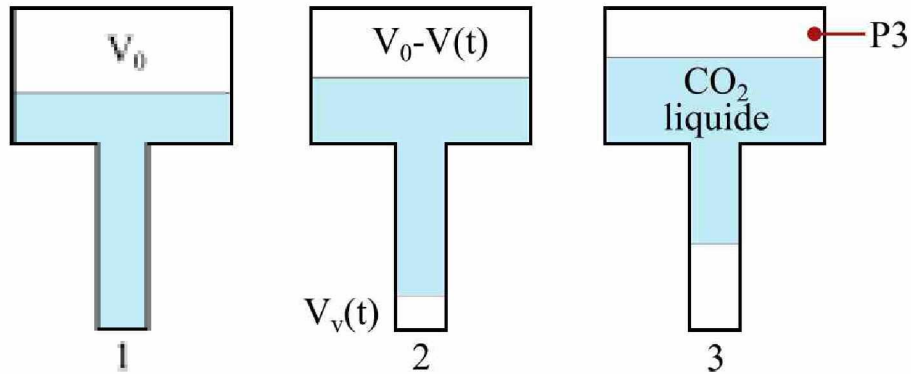

# Buffer layer compression

The fluid is considered incompressible

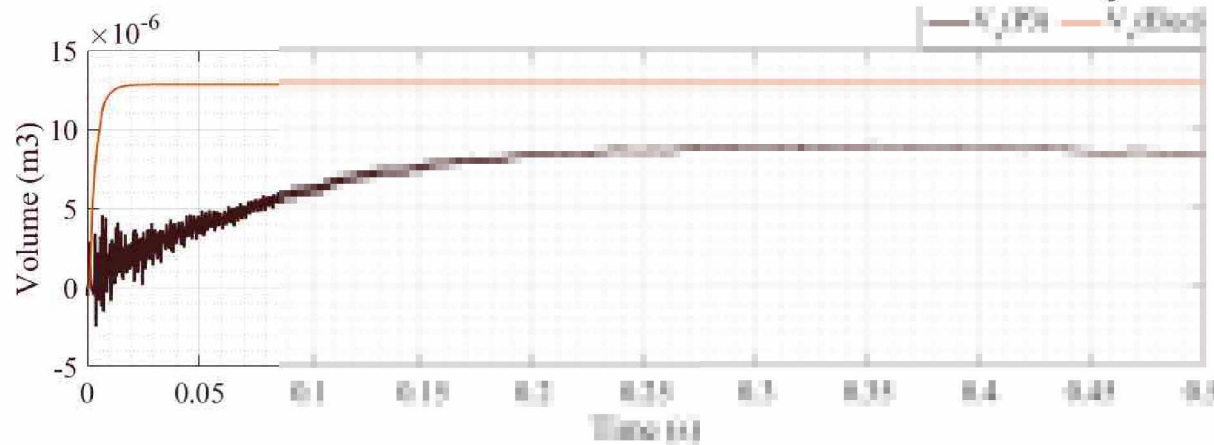
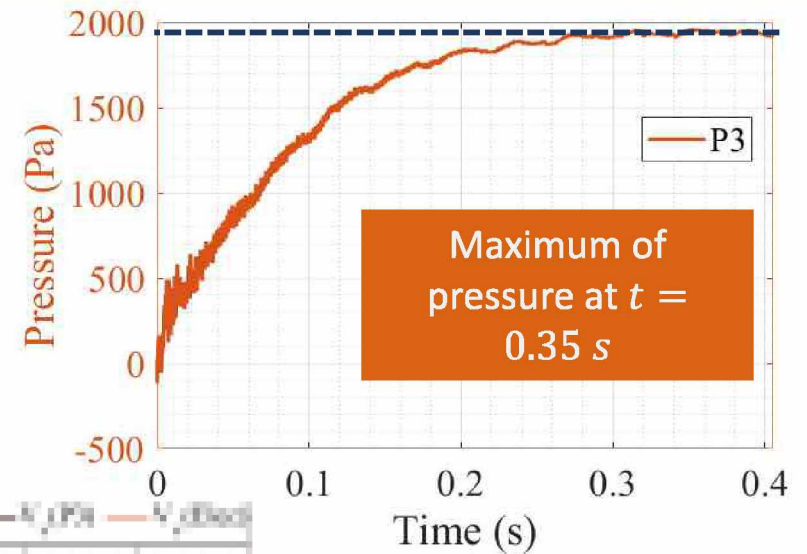
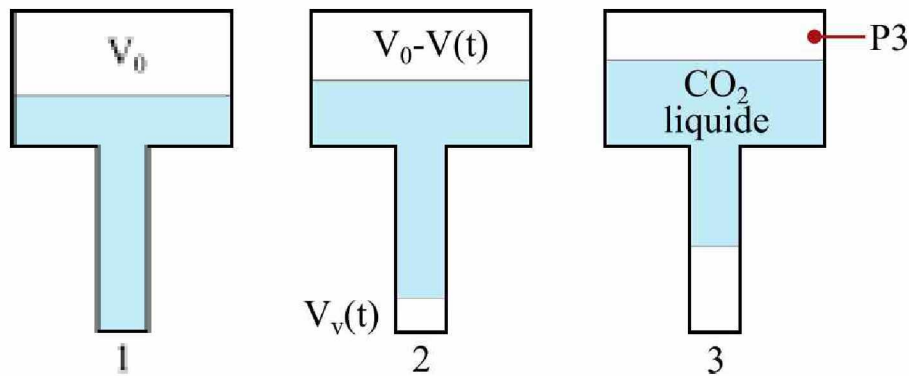

## Asumption:

Isentropic compression of the buffer layer composed of a non ideal gas



# Buffer layer compression

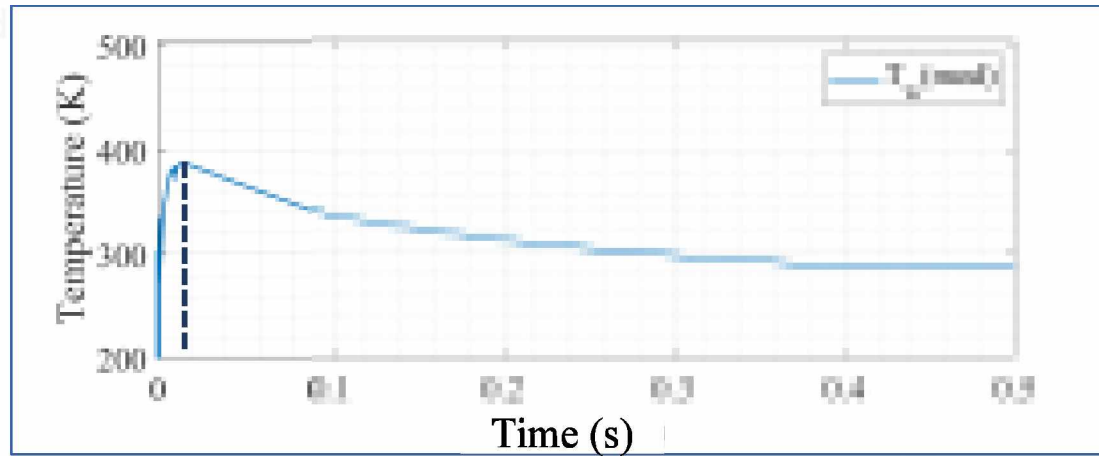

Slower kinetic for  $V_v(real)$

Storage of thermal energy in the tungsten

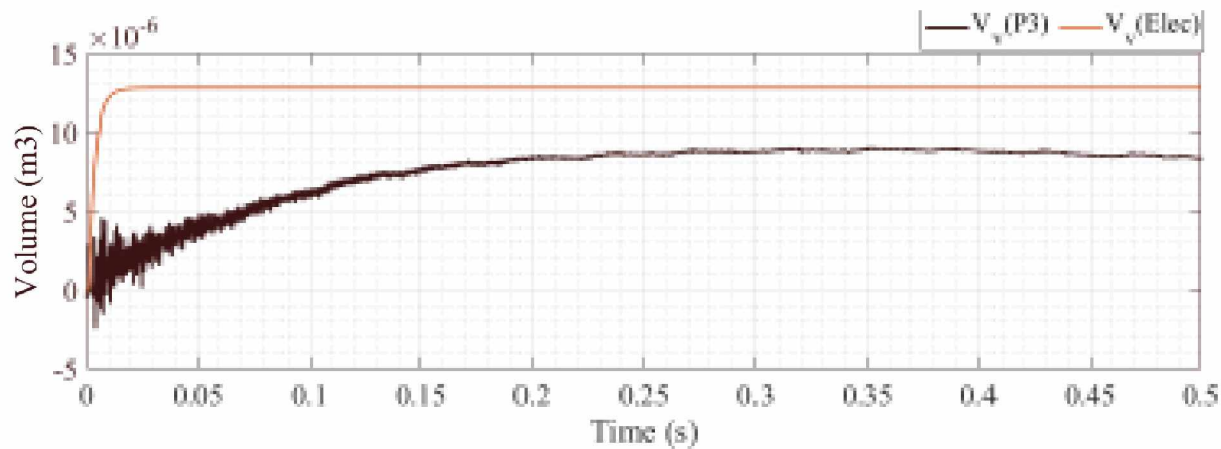

**Asumption:**

Isentropic compression of the buffer layer composed of a real gas

# Test conditions influence on the volume created

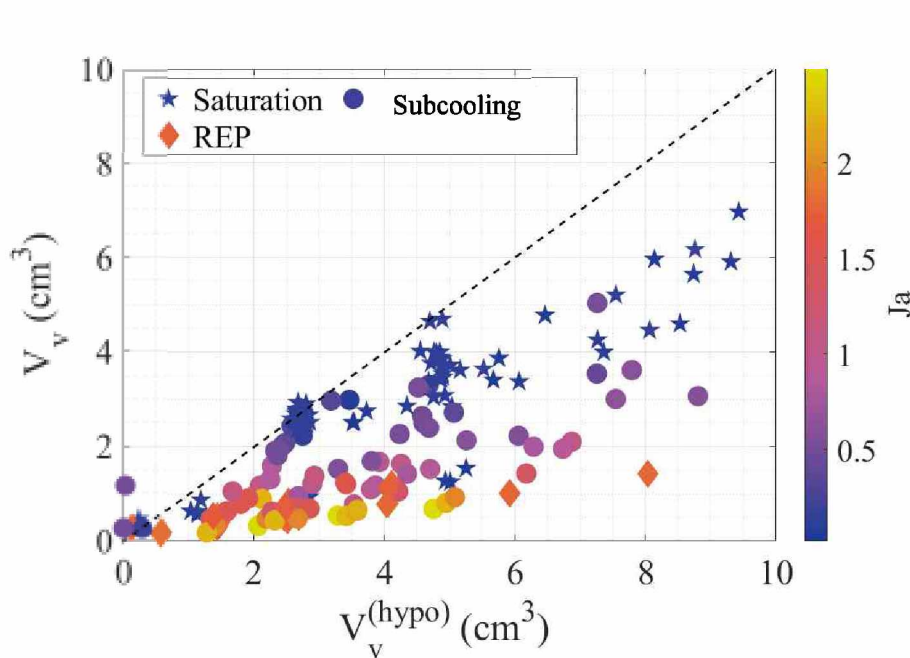

Recondensation of the vapour with an increasing Jakob

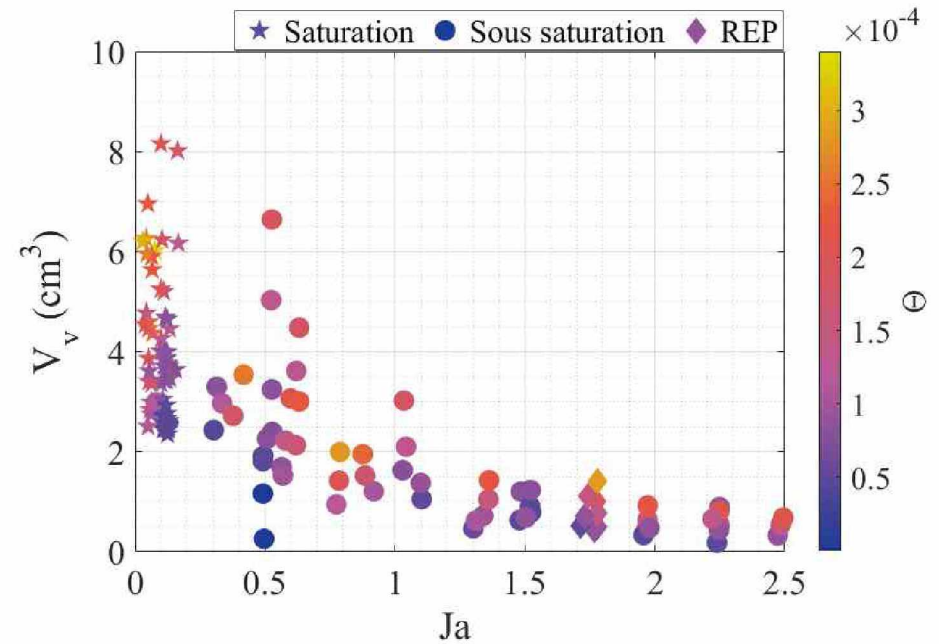

$V_v$  decreases with an increasing  $Ja$

[Incertitudes en annexe](#)

# Test conditions influence on the volume created

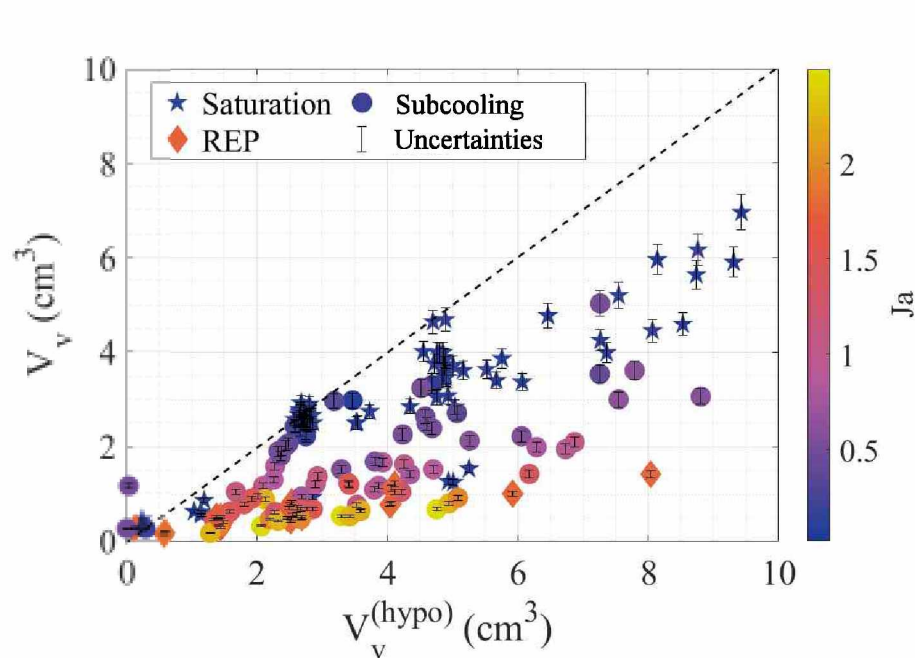

Recondensation of the vapour with an increasing Jakob

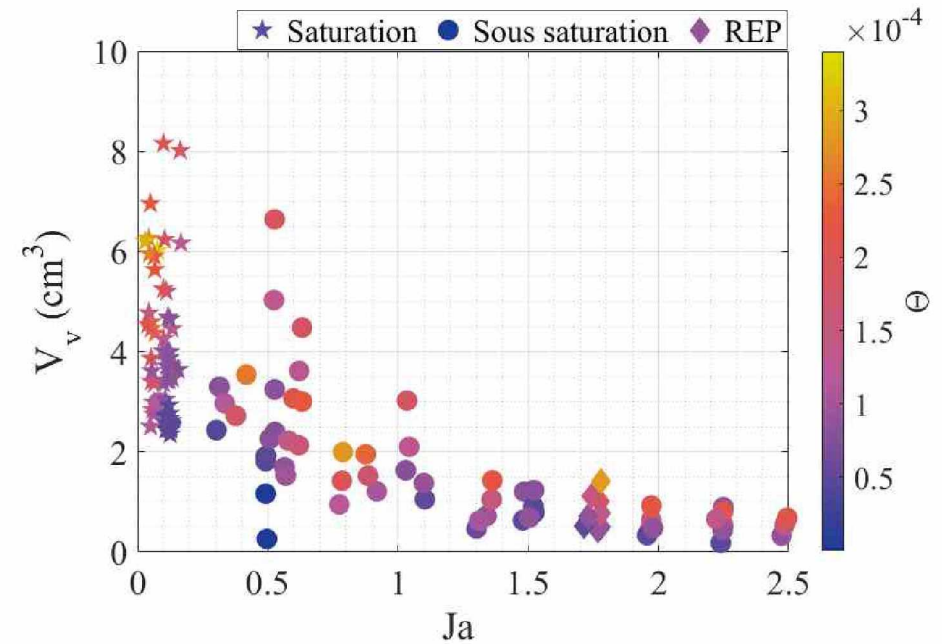

$V_v$  decreases with an increasing  $Ja$

[Incertitudes en annexe](#)

## Conclusion

EDITE

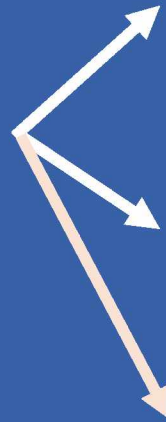

Experimental study of the consequences of a thermal shock

Influence of the test conditions on the phenomena

Theoretical study of the transient phase change

## Prespectives

- Improvement of the thermal analysis
- Use of the theoretical model for all the tests

