



HAL
open science

Influence of pretreatments for extraction of lipids from yeast by using supercritical carbon dioxide and ethanol as cosolvent

Pablo Ezguiel Hegel, Séverine Camy, Philippe Destrac, Jean-Stéphane Condoret

► To cite this version:

Pablo Ezguiel Hegel, Séverine Camy, Philippe Destrac, Jean-Stéphane Condoret. Influence of pretreatments for extraction of lipids from yeast by using supercritical carbon dioxide and ethanol as cosolvent. *Journal of Supercritical Fluids*, 2011, vol. 58 (n° 1), pp. 68-78. 10.1016/J.SUPFLU.2011.04.005 . hal-03539160

HAL Id: hal-03539160

<https://hal.science/hal-03539160>

Submitted on 21 Jan 2022

HAL is a multi-disciplinary open access archive for the deposit and dissemination of scientific research documents, whether they are published or not. The documents may come from teaching and research institutions in France or abroad, or from public or private research centers.

L'archive ouverte pluridisciplinaire **HAL**, est destinée au dépôt et à la diffusion de documents scientifiques de niveau recherche, publiés ou non, émanant des établissements d'enseignement et de recherche français ou étrangers, des laboratoires publics ou privés.



Open Archive Toulouse Archive Ouverte (OATAO)

OATAO is an open access repository that collects the work of Toulouse researchers and makes it freely available over the web where possible.

This is an author-deposited version published in: <http://oatao.univ-toulouse.fr/>
Eprints ID: 6091

To link to this article: DOI:10.1016/J.SUPFLU.2011.04.005
URL: <http://dx.doi.org/10.1016/J.SUPFLU.2011.04.005>

To cite this version: Hegel, Pablo Ezguiel and Camy, Séverine and Destrac, Philippe and Condoret, Jean-Stéphane (2011) Influence of pretreatments for extraction of lipids from yeast by using supercritical carbon dioxide and ethanol as cosolvent. *The Journal of Supercritical Fluids*, vol. 58 (n°1). pp. 68-78. ISSN 0896-8446

Any correspondence concerning this service should be sent to the repository administrator: staff-oatao@listes.diff.inp-toulouse.fr

Influence of pretreatments for extraction of lipids from yeast by using supercritical carbon dioxide and ethanol as cosolvent

P.E. Hegel^{a,b}, S. Camy^{a,b}, P. Destrac^{a,b}, J.S. Condoret^{a,b,*}

^a Université de Toulouse, INPT, UPS, Laboratoire de Génie Chimique, 4, Allée Emile Monso, F-31030 Toulouse, France

^b CNRS, Laboratoire de Génie Chimique, F-31030 Toulouse, France

A B S T R A C T

Saccharomyces cerevisiae is one of the most studied and industrially exploited yeast. It is a non-oleaginous yeast whose lipids are mainly phospholipids. In this work, the extraction of yeast lipids by supercritical carbon dioxide (SCCO₂) and ethanol as a co-solvent was studied. In particular our attention was focused on the selectivity toward triglycerides, and in a subsequent extraction of the phospholipids present in the yeast. Indeed CO₂ is a non-polar solvent and is not an efficient solvent for the extraction of phospholipids. However, SCCO₂ can be used to extract neutral lipids, as triglycerides, and the addition of polar co-solvents like ethanol, at different compositions, allows a more efficient extraction of triglycerides, and also an extraction–fractionation of phospholipids. In this work SCCO₂ extractions of a specific membrane complex of *S. cerevisiae*, obtained from an industrial provider, were carried out at 20 MPa and 40 °C, using ethanol as a co-solvent (9%, w/w). It was shown that different pretreatments are necessary to obtain good extraction yields and have a great impact on the extraction. The kinetic of the extractions were successfully modeled using Sovova's model. From the fitting of the main parameters of the model it was possible to compare the effects of the pretreatments over the yeast material, and to better understand the extraction process. Among the seven tested pretreatments the more appropriate was found to be an acid hydrolysis followed by a methanol maceration.

1. Introduction

Microorganisms have often been considered for the production of oils and fats as an alternative to agricultural and animal resources [1]. The oleaginous yeast species may accumulate more than 20% lipids by mass fraction of their biomass. The main lipidic composition of oleaginous species (*Cryptococcus albidus* and *Rhodotorula glutinis*) are triglycerides (TG), and in minor quantities phospholipids (PL) and sterols [2,3].

The extraction of lipids from yeasts with different conventional organic solvents, such as chloroform and methanol, hexane and/or petroleum ether and their application even at industrial scale have been reported [3]. However, the use of these organic solvents at pilot and industrial scale has to be substituted in the near future by non-flammable, less toxic and more benign solvents in order to obtain sustainable processes [4,5]. Carbon dioxide (CO₂) is an inert, inexpensive, easily available, odorless, tasteless, environment-friendly, and GRAS (Generally Recognized As Safe)

solvent. The supercritical technology is a green sustainable process [6,7] in which the solvent power and selectivity can be tuned according to the operating conditions.

Extraction of lipids from yeast using SCCO₂ has been scarcely considered in the literature. Supercritical studies have been reported for the extraction of high added-value products from yeast, such as astaxanthin and squalene [1,8,9]. More studies can be found for SCCO₂ lipid extraction from algae material [10]. On the other hand, few Refs. [1,11] can be found in the literature about the detailed extraction of lipids from yeasts with CO₂ and co-solvents and the kinetic analysis of the process, especially taking into account the yeast pretreatment, which may have a marked influence on the extraction efficiency. Nevertheless, to palliate this scarce knowledge, it could be of interest, by analogy, to consider works about oil extraction from seeds. The use of SCCO₂ and co-solvents for the selective extraction of TG has been studied, for example, for the extraction of canola, soybean lecithin and sunflower oil [12–17]. Cocero and Calvo [13] have reported a value of sunflower oil solubility in CO₂ around 3.5 g/kg at 20 MPa and 42 °C, value which increases up to nearly 25 g/kg when 10% of ethanol by mass fraction is used as a co-solvent. Also, the addition of polar co-solvents may enhance the solubility of PL which are normally insoluble in pure CO₂ [13,14]. However, Dunford and Temelli [14] observed that the selectivity of SCCO₂ towards the extraction of

* Corresponding author at: Université de Toulouse, INPT, UPS, Laboratoire de Génie Chimique, 4, Allée Emile Monso, F-31030 Toulouse, France.
Tel.: +33 5 34323713; fax: +33 5 34323690.

E-mail address: jeanstephane.condoret@ensiacet.fr (J.S. Condoret).

Nomenclature

a_0	specific surface area per unit volume of extraction bed (m^{-1})
a_s	specific area between the regions of intact and broken membranes (m^{-1})
d_p	particle diameter (m)
D_L	axial dispersion coefficient (m^2/s)
D_{12}	binary diffusion coefficient (m^2/s)
e	extraction yield (lipids/(TG-free yeast) kg/kg)
j_f	flux from broken cells or membranes to solvent ($\text{kg}/\text{m}^3 \text{ s}$)
j_s	flux from intact cells or membranes to broken cells ($\text{kg}/\text{m}^3 \text{ s}$)
k_f	fluid-phase mass transfer coefficient (m/s)
k_s	solid-phase mass transfer coefficient (m/s)
K	partition coefficient (TG-free yeast/solvent, kg/kg)
L	extraction bed length (m)
P	pressure (MPa)
Pe	Peclet number
PL	phospholipids
q	relative amount of the passed solvent (CO_2 /TG-free yeast, kg/kg)
r	grinding efficiency (fraction of broken membranes or non-bound lipids)
t	extraction time (s)
T	temperature ($^\circ\text{C}$)
TG	triglycerides
U	interstitial fluid velocity (m/s)
x_u	concentration in the untreated solid (lipids/TG-free yeast, kg/kg)
x_t	transition concentration (lipids/TG-free yeast, kg/kg)
x_1	concentration in broken cells (lipids/TG-free yeast, kg/kg)
x_{10}	initial concentration in broken cells (lipids/TG-free yeast, kg/kg)
x_2	concentration in intact cells (lipids/TG-free yeast, kg/kg)
x_{20}	initial concentration in intact cells (lipids/TG-free yeast, kg/kg)
y	fluid-phase concentration (lipids/solvent, kg/kg)
y_0	initial fluid-phase concentration (lipids/solvent, kg/kg)
y_s	solubility (lipids/solvent, kg/kg)
$y^*(x_1)$	equilibrium fluid-phase concentration (lipids/solvent, kg/kg)
z	axial co-ordinate (m)
ε	bed void fraction
ρ_f	solvent density (kg/m^3)
ρ_s	solid density (TG-free yeast/solid phase, kg/m^3)
μ	viscosity (Pa s)

oil from canola flakes was not affected by the addition of ethanol (8% by mass fraction) even at 55.2 MPa and 70°C . These authors reported the extraction of an increasing amount of PL when canola flakes of reduced oil content were extracted at the same operating conditions. Teberikler et al. [15] reported selectivity towards phosphatidylcholine at 20 MPa and 60°C with a low thermodynamic solubility values, around 0.15 g/kg in the SCCO_2 , with 10% (w/w) of ethanol as a co-solvent.

The objective of this work is related to the SCCO_2 extraction of TG from yeast material. The extraction conditions were selected according to previous works at 20 MPa and 40°C , using 9% (w/w)

of ethanol as a co-solvent in order to obtain solvent power and selectivity towards TG extraction. The raw material used in this work was a yeast membrane complex of high lipidic content, provided by a major European industrial yeast provider. The material was submitted to different pretreatments in order to increase yield and selectivity. Modeling of the extraction kinetics was done using the Sovova's mathematical model of broken and intact cells (BIC), very often used in the literature. When applied to fit the experimental cumulative extraction curves, its application to assess the SCCO_2 + ethanol lipid extraction proved to be useful for a better understanding of the pretreatments efficiency.

2. Materials and methods

2.1. Yeasts

A specific material termed "dried membrane complex of *Saccharomyces cerevisiae*" (DMCS) of high lipid content and provided by Lesaffre Group® has been used in this work. This complex is obtained by harvesting autolysed yeasts, then heating ($\sim 100^\circ\text{C}$) and drying by atomization at 60°C , to obtain a dry powder with a mean particle diameter of 70 μm and a humidity content of around 8%. DMCS exhibits high lipidic content, nearly 20% by mass fraction of dry material. The measured solid density of the DMCS is $1130 \text{ kg}/\text{m}^3$.

2.2. Soxhlet extraction and characterization of extracted lipids

Lipid content of the yeasts was gravimetrically determined by Soxhlet extraction (8 h) with solvents of technical grade and solvent mixtures of different polarities (hexane, ethanol and chloroform-methanol in different volume ratios). The solvents were recovered in a rota-evaporator which was operated with a vacuum pump. The crude lipidic extracts obtained from Soxhlet extractions contain carbohydrates, proteins, and other unwanted materials which were separated by a method based on the work of Hubbard et al. [18]. According to Soxhlet extractions done with different solvents, Table 1 shows the total lipidic content after separation from non-lipidic material.

Phospholipids (PL) present in the total lipidic amount (1–3 g) obtained by Soxhlet extraction were separated and quantified by dispersion in cold acetone (90 ml), which is assumed to only dissolve neutral lipids [19,20]. In this work, the fraction of lipids which is insoluble in acetone is assumed to be the PL fraction. Lipids which are soluble in acetone are in turn assumed to be TG and fatty acids. Table 2 shows the fraction of lipids which is insoluble in acetone.

Fatty acid analysis of extracted lipids was carried out by gas chromatography (Thermo-Finigan chromatograph). The equipment comprised a flame ionization detector (FID) and a capillary column (WCOT Fused Silica 25 m \times 0.25 mm ID DF=0.4 Coating, CP-sil 8CB). A solution of TMSH (trimethylsulfonium hydroxide) in methanol (0.2 M) was used to operate lipid transesterification for the analysis of fatty esters composition present in TG. Helium was used as the gas carrier at a flow rate of 2 ml/min and at a split flow equal to 1/20. The injector and detector temperatures were 220°C and 260°C , respectively. The oven temperature program consisted in starting at 50°C during 6 min, then setting a ramp of $7^\circ\text{C}/\text{min}$ up to 210°C , a ramp of $15^\circ\text{C}/\text{min}$ up to 250°C , and finally maintaining 250°C during 15 min.

Fatty acid composition of acetone soluble lipids is reported in Table 3 and Fig. 1 shows a typical gas chromatogram.

2.3. Supercritical extractions

Supercritical extractions were carried out in a pilot plant from Separex Chimie Fine, France (SF 300 type) represented in Fig. 2

Table 1
Soxhlet lipid extractions by organic solvents. Total lipid content in substrates (lipids/yeast, w/w).

	Hexane	Ethanol	Chloroform:methanol (2:1)	Chloroform:methanol (1:2)
Memb. complex (C1)	0.001	0.22	0.212	0.23
Memb. complex (C2)	0.050	–	0.199	–
Memb. complex (C3)	0.051	–	0.230	–

C1: heated and dried by atomization, C2: acid pretreatment by 4 h, C3: acid pretreatment by 8 h.

Table 2
Phospholipids content by mass fraction in yeast obtained by dispersion in cold acetone of the total lipids extracted by Soxhlet (lipids/yeast, w/w).

	Hexane	Ethanol	Chloroform:methanol (2:1)	Chloroform:methanol (1:2)
Memb. complex (C1)	–	0.066	0.062	0.069
Memb. complex (C2)	0.0	–	0.014	–
Memb. complex (C3)	0.0	–	0.01	–

C1: heated and dried by atomization, C2: acid pretreatment by 4 h, C3: acid pretreatment by 8 h.

Table 3
Fatty acid composition of acetone soluble lipids extracted by Soxhlet with chloroform:methanol (2:1) as solvent. Mass fractions are normalized according to the total fatty acids found in the analysis.

	C14	C16:0	C16:1	C18:0	C18:1
Fatty acids %, w/w	1.3	12.5	51.4	3.8	30.5
Total fatty acids %, w/w			72.1		

It comprises two cyclone separators in series and a maximum CO₂ flow rate of 6 kg/h can be operated. Extraction cylinders of different capacities: 54 cm³, 104 cm³, and 228 cm³ (41.5 mm *i.d.*) were available. A detailed description of the experimental procedure and the experimental set-up can be found in previous papers [17,21]. In this work, a co-solvent (ethanol 9% by mass fraction) was used to increase the solvent power of CO₂ and also to allow easier mechanical recovery of the extract in the separators. Briefly, the heating system was set at the desired temperature (40 °C); the extraction cylinder was filled with a given amount of substrates (33 g, in the small vessel, 60 g in the medium capacity and 140 g in the biggest one) and placed inside the extractor vessel. Once the high pressure extractor vessel was closed, carbon dioxide was pumped at the desired temperature into the extractor up to reach the operating pressure (20 MPa); then a given amount of ethanol was pumped to the vessel up to obtain the desired fraction by mass percent of ethanol as co-solvent. A static extraction period of 15 min was initiated to reach the desired process conditions, and solvent and co-solvent were subsequently pumped at the desired flow-rate which was set at 30 g/min for these extraction studies. The

extraction pressure was maintained by a back pressure regulator (BPR). The outlet line of the BPR was connected to the first separator regulated at 7.0 MPa by another BPR valve whose outlet line was connected to the last separator operated at 5.0 MPa.

Unequally time spaced samples (12–18 min) were taken in all cases during the total extraction time (120–180 min). The samples from the bottom of separators were collected along the time in 15 cm³ capacity glass vials. Then ethanol was recovered at 40 °C in a rota-evaporator operated with a vacuum pump.

Additional studies were done in the 228 cm³ extraction vessel to check if insufficient residence time, in respect to possible external mass transfer problems, could have affected the extraction results.

3. Modeling of the extraction process

The mathematical model adopted in this work is the model of Broken and Intact Cells (BIC), a general approach proposed by Sovová [22]. This model is useful because it accounts for the pseudo-linear initial part of the extraction curves, which has often been experimentally observed, especially in the case of oilseed extraction. It is particularly suited for fitting this kind of experimental data as it almost independently simulates two extraction periods, the first one being governed by phase equilibrium and the second one by internal diffusion inside particles.

An important feature of the BIC model proposed by Sovová [22] is to make it possible to consider different types of pseudo-equilibria in the first extraction period: independent on matrix (solubility equilibrium) and/or adsorbed on the matrix (partition

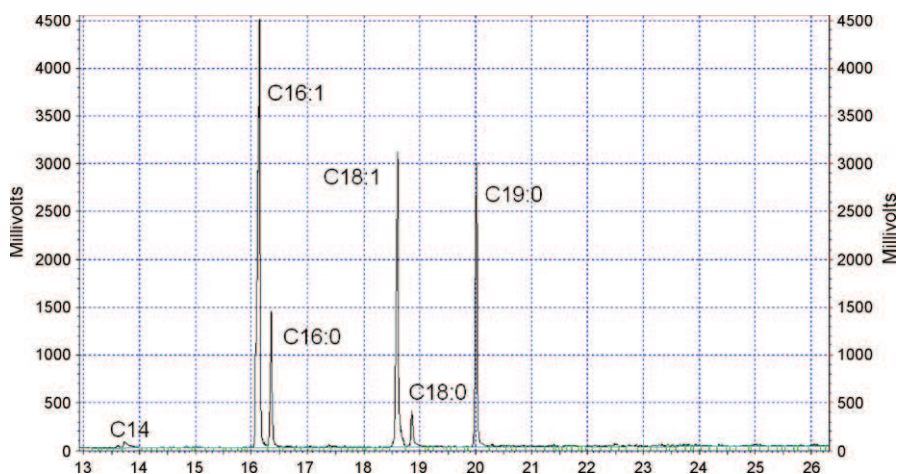

Fig. 1. Typical gas chromatograph analysis of the yeast membrane complex DMCS extracted by Soxhlet with organic solvent, after separation of phospholipids by dispersion in cold acetone.

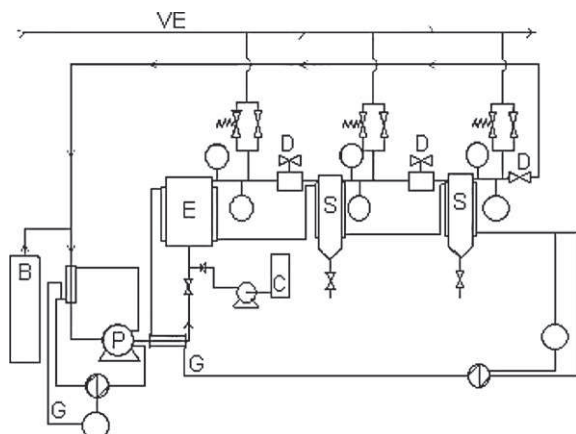

Fig. 2. Simplified flowsheet of the pilot SF 300: B, CO₂ cylinder; E, extractor; S, separators; P, pump; G, cooling and heating group; D, back pressure regulator valves; C, co-solvent; VE, venting system.

coefficient). From an examination of extraction curves obtained in the present work, and especially from the order of magnitude of the observed fluid phase output composition during the initial extraction step, it has been decided to use ‘type A’ and ‘type D’ of the BIC model, depending upon the different pretreatments of the DMCS. Indeed, ‘type A’ extraction curves are representative of systems without solute-matrix interaction, and the value of the initial output fluid phase composition corresponding to the first part of the extraction curve (also termed in the literature as ‘initial apparent solubility’) is close to the thermodynamic solubility of the solute in the supercritical solvent, except when strong external mass transfer effects are present.

‘Type D’ extraction curves are representative of strong matrix-solute interactions and the pseudo-equilibrium is present in the system from the very beginning of the extraction. The maximum composition of solute in the solvent is proportional to the solute composition in the broken cells and is given by a partition coefficient (K). In this case, the initial output fluid phase composition may be much lower than the thermodynamic solubility of the solute in the supercritical solvent.

The reader can be familiarized with the parameters involved in the model in Appendix which presents the final system of time ordinary differential equations, with the spatial derivative term $\partial y/\partial z$ represented by finite differences ($\Delta y/\Delta z$). These equations were numerically integrated using the Runge-Kutta-Fehlberg method and yielded the composition of lipids inside the solid material as a function of the extraction time.

The external mass transfer coefficients ($k_f a_0$), values were estimated according to different correlations [23–27]. To estimate the degree of axial dispersion in the extractor vessel, Peclet (Pe) numbers, based on the height of the packed bed, were calculated by the

correlation of Catchpole [28]. Table 4 summarizes the values of the estimated parameters as a function of particle diameter.

Porosity of the solid was estimated from the value of solid density of the inert material, ρ_{sol} , and value of the apparent density, ρ_{ap} , obtained from the mass of material treated per volume of cylinder capacity. Solid densities of the inert material were in turn experimentally estimated by pycnometry. The values of the physico-chemical properties of the solvent (ρ , μ and D_{12}) used in this work are summarized in Table 5.

Fractions of broken cells or non-bound lipids and internal mass transfer parameter were left as parameters to be fitted. In the case of ‘type D’ of the BIC model, a third parameter, the partition coefficient, K , was determined from the slope of the first part of the extraction curve and the fraction of broken cells of the material.

4. Results and discussion

4.1. Selectivity and solubility of lipids with the mixture CO₂ + ethanol

To uncouple matrix effects from the solvent efficiency, a preliminary study of the solvent power and selectivity of the CO₂-ethanol mixture in respect to the extractable compounds has been proposed. This was done by directly processing samples of lipidic extract obtained from Soxhlet extraction (using methanol + chloroform mixtures). Glass beads (1 mm) were impregnated with a given amount of lipidic extract (ca. 3.6 g) obtained from the Soxhlet (this amount corresponds to the quantity of lipids contained in 17.7 g of yeast). The smaller extraction vessel of 54 cm³ was used in this study, following the extraction procedure explained above. The target was to estimate the selectivity of the solvent (SCCO₂ + ethanol 9%, w/w) in respect to lipids. The extraction curve is shown in Fig. 3 and 69% of the total lipids were found to be extracted while the non-extracted part remained on the glass beads inside the extraction vessel. The remaining non-extracted lipids on the glass beads were checked to be acetone insoluble, in agreement with the previous results obtained in the Soxhlet studies, and are therefore assumed to be PLs. Fatty acid analysis of the extracted lipids showed a composition similar to that of the lipids extracted by Soxhlet and then fractionated by cold acetone, with in this specific case 80% by mass fraction of total ester composition. It can be seen in Fig. 3 that an estimated specific solvent mass ratio, q , equal to 55 made it possible to selectively extract almost 90% of the TGs. This value of the selectivity was also observed in oilseed extraction. For example, Cocero and Calvo [13], at similar operating conditions, obtained only 0.06 g of PL/kg oil extracted. Montanari et al. [16] obtained 0.7 g of PL/kg of “defatted” soybean flakes at 23 MPa and 60 °C.

The output fluid phase composition observed in this study was 4.5 g of lipids/kg CO₂. This relatively high value is nevertheless significantly lower than the initial apparent solubility observed

Table 4

Parameters used in the BIC model for the SCCO₂ + ethanol extraction of lipids from the membrane complex of *S. cerevisiae*. Estimated by correlations from literature.

Material	d_p^a (mm)	a_0 (m ⁻¹)	Ue (cm s ⁻¹)	$k_f a_0^d$ (s ⁻¹)	$k_f a_0^e$ (s ⁻¹)	$k_f a_0^f$ (s ⁻¹)	$k_f a_0^g$ (s ⁻¹)	$k_f a_0^h$ (s ⁻¹)	Pe^i
M.C1 ^b	0.073	38576	0.049	1.30	0.036	0.72	0.062	0.037	166
M.C2 ^c	0.309	10078	0.049	0.27	0.038	0.14	0.066	0.037	20

^a Mean diameter after material pretreatments.

^b Membrane complex heated and dried by atomization and then submitted to different pretreatments.

^c Membrane complex submitted to acid pretreatment, then dried by convection at 60 °C and milled by knife grinder.

^d Tan et al. [23].

^e Lee and Holder [24].

^f Puiggené et al. [25].

^g Sovová et al. [26].

^h Cocero and Garcia [27].

ⁱ Peclet number calculated according to axial dispersion from [28] for the extraction cylinder of 54 cm³ capacity.

Table 5
Physical properties used in the BIC model for the SCCO₂ extraction.

T (°C)	P (MPa)	Y ^{*a} lipid/CO ₂ (g/kg)	ρ _f ^b (kg m ⁻³)	μ ^c (Pa s)	D ₁₂ ^d (m ² s ⁻¹)
40	20	25	840	7.72 × 10 ⁻⁵	5.5 × 10 ⁻⁹

^a TG solubility from Cocero and Calvo [13].

^b Mixture density. CO₂ Density from National Institute for Standards and Technology [29]. Ethanol density from Perry's Handbook [30].

^c Mixture viscosity estimated according to the method of Grunberg and Nissan [31]. Viscosity of pure CO₂ estimated from Jossi et al. [31]. Liquid ethanol from Perry's Handbook [30].

^d Binary diffusion coefficient (D₁₂) for triglycerides in CO₂ estimated using the equation of Catchpole and King [32].

by Cocero and Calvo [13] for the extraction of sunflower oil with SCCO₂ + ethanol at the same operating conditions (20 MPa and 315 K), which was around 25 g of oil/kg CO₂. The output fluid phase composition increased from 4.5 g/kg to 9.4 g/kg with the height of the extraction cylinder ranging from 54 cm³ to 228 cm³ (*i.d.*: 41.5 mm) with a CO₂ flow rate equal to 30 g/min. This increase was more pronounced at lower flow-rate (20 g/min CO₂) where a value of 18 g/kg was reached.

Furthermore, similar experiments were conducted using commercial sunflower oil. This was done in order to easily compare the results with those of Cocero and Calvo [13]. The results obtained are in the same order of magnitude than the ones obtained for yeast lipids, *i.e.*, 16 g of oil/kg of CO₂ (228 cm³ configuration). So, this result could be associated to external mass transfer limitations and/or hydrodynamical problems in our system which prevent from attaining the thermodynamic solubility in the CO₂ output. However, the complete study of the hydrodynamic behavior of supercritical phase on mass transfer rate was beyond the scope of this work. Sovová et al. [26] also observed similar problems in the oil extraction of grape seeds when CO₂ was pumped in up-flow configuration (opposite to gravity). A detailed study of the effect of flow direction upon the external mass transfer coefficient can be found in the works of Puiggené et al. [25] and Stüber et al. [33]. These authors observed a strong dependence of the extraction rate upon solvent flow-rate and also upon gravity-assisted direction, especially for particles of large diameter and highly soluble compounds.

An approach similar to the one of Tan et al. [23] was used to determine the volumetric external mass transfer coefficient, $k_f a_0$, in order to compare these values with those of the literature [23–27]. Table 6 summarizes the values of $k_f a_0$ obtained in this work, and shows that these values are one order of magnitude lower than $k_f a_0$ values obtained by Cocero and Garcia [27] for the extraction of sunflower oil with SCCO₂ and ethanol at similar operating conditions ($k_f a_0 = 0.012 \text{ s}^{-1}$ and $k_f a_0 = 0.057 \text{ s}^{-1}$ for superficial velocities

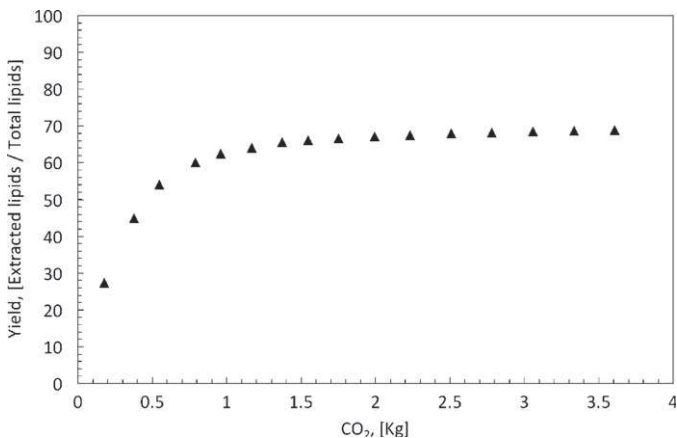

Fig. 3. Extraction of lipids from DMCS with SCCO₂ (30 g/min, 40 °C and 20 MPa) and 9% (w/w) of ethanol as co-solvent. (▲) experimental data of direct extraction of lipids previously obtained by Soxhlet with chloroform:methanol as the solvent (70% of these lipids are soluble in CO₂).

from 1.1 cm/min to 2.5 cm/min). The values obtained in this study are also one order of magnitude lower than the values calculated by correlations proposed in the literature which take into account the particle size (Table 4). Also, at the lowest flow-rate, using the highest capacity extractor, the external volumetric mass transfer coefficient, $k_f a_0$, was shown to increase. Axial dispersion was estimated (from [28]) and the Peclet number (according to the glass beads diameter (1 mm)) was estimated around $Pe = 5$ and $Pe = 18$, for bed heights of 4.5 cm and 16 cm, respectively. This is indicating that axial dispersion phenomena can have a significant influence on the extraction efficiency [34].

From these results, values of $k_f a_0$ calculated in this section were used to model the supercritical extraction of the DMCS complex subjected to different pretreatments. When free lipids were present in the substrate, 'type A' of BIC model was selected to represent the cumulative extraction curves.

4.2. SCCO₂ + ethanol extractions of dried yeast membrane complex (DMCS)

Most of the extraction studies using SCCO₂ with and without co-solvent were done here in the lowest capacity extraction cylinder of 54 cm³.

Processing of DMCS with pure CO₂ (operating conditions: 20 MPa, 40 °C and 30 g/min) produced very low yields and it was not possible to follow the extraction kinetics. Around 3 g of lipids by kg of raw material were obtained after 150 min. This value was obtained with recovery of the extract by final cleaning of the extraction plant with ethanol. Indeed, this low yield was expected regarding results of the Soxhlet extraction (Table 1) where hexane extraction produced only 0.1% by mass fraction of lipids.

Fig. 4 shows the results of the SCCO₂ extraction of DMCS using 9% by mass fraction of ethanol in a CO₂ flowrate equal to 32 g/min, at 20 MPa and 40 °C. The effect of residence time upon initial output fluid phase composition and rate of internal mass transfer was tested by increasing the extraction cylinder capacity from 54 cm³ to 104 cm³. From the initial slopes of the two curves, initial output fluid phase composition y_0 were found to be 0.36 g lipids/kg CO₂ whatever the extractor capacity. Values of the Peclet number for the different extractor capacities ($Pe = U\epsilon L/D_L = 166$ for $L = 0.045$ m and $Pe = 298$ for $L = 0.077$ m, axial dispersion coefficient calculated according to [28]), were indicating in this case negligible axial dispersion effects [34].

Because very low initial output fluid phase composition values are characteristic of strong matrix-solute interaction, 'type D' model was selected. Its equilibrium adsorption constant was estimated from initial slope values and from equation 6 (see

Table 6
 $k_f a_0$ calculated from the experimental results according to [23].

Cylinder capacity (cm ³)	Flow-rate (g/min)	y_0 (g/kg)	$k_f a_0$ (s ⁻¹)
54	30	4.5	0.0014
228	30	9.4	0.0016
228	20	18	0.0045

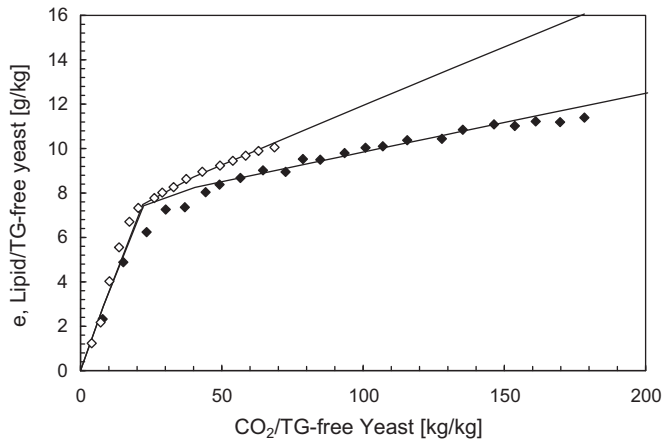

Fig. 4. SCCO₂ + ethanol extraction of DMCS. Residence time effect on initial output fluid phase composition “ y_0 ” and internal mass transfer extraction rate. Symbols are experimental curves: (◆) 54 cm³ and (◇) 104 cm³ extraction cylinder capacity. Lines are ‘type D’ of BIC model.

Appendix). The volumetric external mass transfer coefficient, estimated according to Tan et al. [23], the value $k_f a_0 = 1.3 \text{ s}^{-1}$ and the one obtained from Lee and Holder [24], $k_f a_0 = 0.036 \text{ s}^{-1}$, were tested in the model. However, the obtained final fitted parameters were similar. Actually, $k_f a_0$ values greater than 0.02 s^{-1} proved to correspond to low external mass transfer resistance. Model fitting, in this case, was done by adjusting the fraction of broken cells, r , and the internal volumetric mass transfer, $k_s a_s$, and fitting process showed that these parameters have a weak interdependence. Indeed, parameter r adjusts the point at the end of the first part of extraction curve, where initial apparent solubility y^* or external mass transfer, controls the extraction. Parameter $k_s a_s$, in turn, allows adjusting the second part of the extraction curve, where internal mass transfer governs the process. A good agreement between the model and experimental data can be observed in Fig. 4.

The value found for the parameter $k_s a_s = 1.3 \times 10^{-6} \text{ s}^{-1}$ is low in respect to values normally found for SCCO₂ extraction of oilseeds [35], which are at least two orders of magnitude greater. Fig. 5 shows SEM (Scanning Electro Microscope) images of DMCS. It can be seen a non-porous material; actually, the plasma membranes are strongly corrugated in a way that the lipids may not be exposed to the solvent (Fig. 5b and c). The walls of the membrane seem to be very compact (Fig. 5d) explaining very low values of $k_s a_s$ adjusted with ‘type D’ of the BIC model.

Results obtained from the extraction of non pre-treated DMCS obviously indicated the need for pretreatment in order to increase the material porosity, and also to weaken the interaction between lipids and biopolymers which are present in the membranes.

In this case, fatty acid analysis of the extracted lipids revealed 66% of total fatty esters. Indeed, relative composition of fatty acids was very similar to the one obtained in the analysis of Soxhlet extracted lipids. Also, this result could be explained by the co-extraction of sterols and glycolipids (soluble in acetone) which constitute the inert part of the membrane complex and which are solubilized when ethanol is used as a co-solvent [36].

4.3. Influence of pretreatments of DMCS

The different pretreatments applied to the yeast membrane complex which were tested in this work are summarized in Table 7. Detailed descriptions of the pretreatments are given below in this section. Fig. 6 shows cumulative extraction curves as a function of specific mass solvent ratio, q , for the extraction of DMCS subjected to different pretreatments. The 54 cm³ cylinder extractor was used in these extraction experiments at 20 MPa and 40 °C with 9% of ethanol as a co-solvent and at a CO₂ flow-rate of 30 g/min. Fig. 6 also includes the best fit lines obtained with the BIC model according to the parameters reported in Table 8.

Pretreatment 1: Thermal pretreatments are normally applied in the industry of edible oils in order to coagulate proteins, to decrease oil affinity for the solid surface and to agglomerate the oil into larger droplets [37]. The material DMCS was cooked for 30–40 min at 90 °C and 120 °C in a ventilated oven. The extraction curve for this

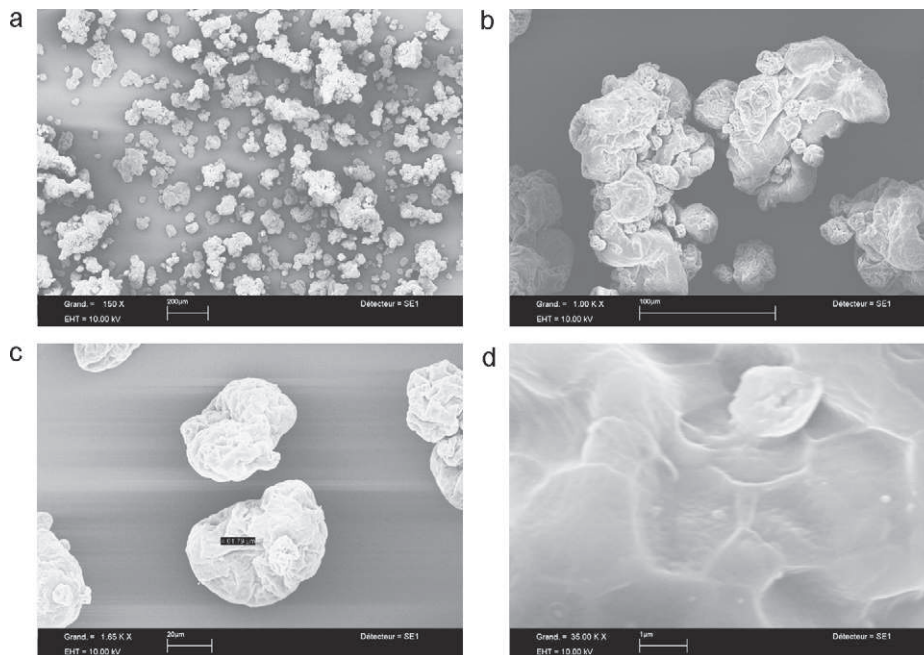

Fig. 5. SEM images of original yeast membrane complex DMCS. (a) Regular distribution of DMCS material with corrugated membranes. (b and c) Spatial distribution of the membranes. (d) Surface of the membranes.

Table 7

Pretreatments of the DMCS material studied in this work for the SCCO₂ + ethanol extraction of triglycerides.

No. of pretreatment	Description
1	Cooking during 30 min at 90 °C or 120 °C
2	Disruption by rapid decompression after exposure to SCCO ₂
3	Extra-drying of the material at 60 °C overnight and milling process.
4	Maceration in ethanol overnight, drying in rota-evaporator at 60 °C and milling.
5	Harvesting, acid pretreatment during 4 h, filtering, heating (>100 °C) and drying by atomization (whole pre-treatment done by the provider).
6	DMCS re-suspended in an acidic solution during 4 h (pre-treatment done by the provider). Then the material was filtered and dried in an air oven at 60 °C, overnight. Dried material was milled in a knife grinder and size-classified with a mean particle diameter of 300 μm.
7	Idem 6. Then, maceration with methanol during 1 h.

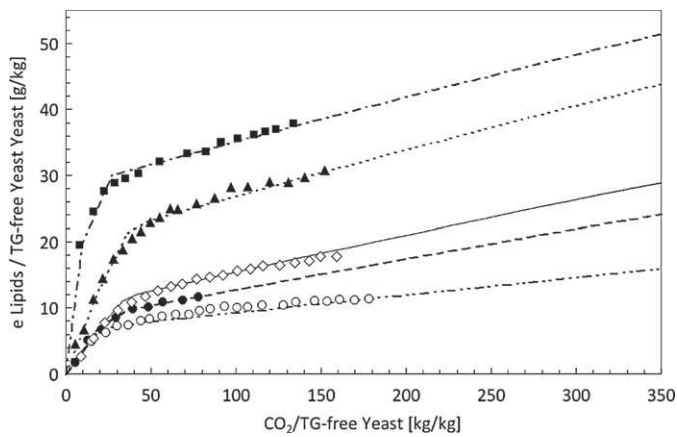

Fig. 6. Extraction of DMCS in 54 cm³ cylinder extractor volume with SCCO₂ (30 g/min 40 °C and 20 MPa) and 9% (w/w) of ethanol, and subjected to different pretreatments. Symbols are experimental data: (○) untreated DMCS, (●) DMCS after pretreatment 2, (◇) DMCS after pretreatment 1.1, (▲) DMCS after pretreatment 3, (■) DMCS after pretreatment 4. Lines are 'type D' model fitting with parameters reported in Tables 6 and 8.

pre-treated material (Fig. 6) showed that soluble lipids still have a strong interaction with the matrix from the start of the extraction process. It yielded similar values of y_0 and $k_s a_s$ parameters (Table 8). The output fluid phase composition in the first extraction period is 0.36 g of lipids/kg of CO₂ and, as explained before, is still one order of magnitude lower than the initial composition obtained in the extraction of pure yeast lipids as reported in Table 6 at the same operating conditions and for the lower capacity extractor. It

Table 8

Parameters used in the BIC model for the SCCO₂ + ethanol extraction of lipids from the membrane complex of *S. cerevisiae* submitted to different pretreatments (pretreatments are numerated according to Table 7). Parameters $k_s a_s$ and r are obtained from numerical fitting of the experimental cumulative extraction curves obtained in extractor capacity of 54 cm³.

No.	Material	d_p (mm)	ε	ρ_s (kg m ⁻³)	$k_s a_s$ (s ⁻¹)	r	y_0 (g/kg)
0	DMCS	0.073	0.54	1130	1.3×10^{-6}	0.039	0.36
1	DMCS-Cooking 90 °C	0.073	0.54	1130	2.6×10^{-6}	0.051	0.36
1.1	DMCS-Cooking 120 °C	0.073	0.54	1130	2.6×10^{-6}	0.058	0.36
2	DMCS-SCF disruption	0.073	0.54	1130	2.4×10^{-6}	0.051	0.36
3	DMCS-drying-milling	0.070	0.53	1100	3.2×10^{-6}	0.110	0.65
4	DMCS-EtOH overnight	0.071	0.63	1050	3.0×10^{-6}	0.140	2.00
5	acid pretreatment 1	0.074	0.63	908	2.4×10^{-6}	0.110	0.13
6	acid pretreatment 2	0.309	0.48	990	1.6×10^{-5}	0.310	3.5
7	acid pretreatment 2Alcohol maceration	0.302	0.48	1004	1.0×10^{-5}	0.446	3.7

is two orders of magnitude lower than the thermodynamic solubility (25 g oil/kg CO₂). The value of partition coefficient, $K = 0.0019$ (calculated from the slope of the cumulative extraction curves and Eq. (6) as given in Appendix), evidences a strong matrix-oil interaction when compared to the value corresponding to the non-bound solute extraction, using extract impregnated glass beads, where $K = 0.026$ ($K = y_0/x_{1,0}$, where $x_{1,0}$ is the amount of oil divided by the mass of inert material). However, the fraction of broken cells or non-bound lipids, r , was found to increase from 3.8% in the original material to 5.9% with the thermal pretreatment at 120 °C, as shown in Table 8. Also, both temperatures of thermal conditioning, 90 °C and 120 °C, lead to similar values of the volumetric internal mass transfer coefficients $k_s a_s$. However, these values remain in the same order of magnitude than those observed in the extraction of the untreated material, indicating persistence of internal mass transfer limitations.

Chromatographic analyses of the extracted lipids from the DMCS after this pretreatment, reported a fatty acid composition very similar to the original material with a total fraction of ester of 61% by mass fraction.

Pretreatment 2: A disruption method using pressurized CO₂ (SCF disruption) was done according to the procedure described by Lin et al. [38]. Briefly, the material was placed into the extractor and CO₂ was fed up to the experimental pressure and temperature (20 MPa and 40 °C). The system was maintained static during 1 h and then the pressure was suddenly released and the decompression step lasted around 5 s. Two sudden decompressions were done to attempt opening corrugated membranes of the DMCS. However, SCF disruption of the complex barely improved the results in respect to the original material (see in Table 8 the values of the model parameters). Indeed, the fraction of broken cells or non-bound lipids increased from 3.9% to 5.1%. Finally, these results are in same order of magnitude than those obtained by the thermal pretreatment at 90 °C. It is important to mention that, in this work, the SCF disruption was applied to a dried material, while the procedure described in the literature was applied to a wet material. In addition, Lin et al. [38] originally proposed this procedure to break intact yeast cells while the yeast membrane complex used in this work was indeed very different from intact cells of *S. cerevisiae* from a morphological point of view. This may explain the poor results observed with this pretreatment. Lipid composition of extracted lipids was also found similar to our previous results (Table 3).

Pretreatment 3: Incomplete drying of the material could induce problems in the extraction because presence of water may reduce the solvent power of CO₂ [12]. However, ethanol as a co-solvent could help dehydrating the material because of its natural affinity with water. First, to evaluate the humidity content of the original material, DMCS was submitted to overnight extra drying in a convection oven at 60 °C, and its initial humidity content was thus estimated to be 8% by mass fraction. The extra-dried material was then re-milled by a knife grinder to avoid material agglomeration

(no change of the average particle diameter and of the material properties were observed). This new material form was extracted by $\text{SCCO}_2 + \text{ethanol}$ at the same operating conditions than previous one. On the cumulative extraction curve obtained in this specific case (see Fig. 6), a value $y_0 = 0.65 \text{ g lipid/kg CO}_2$ of the output fluid phase composition can be observed, with parameters $r = 0.11$ and $k_s a_s = 3.2 \times 10^{-6} \text{ s}^{-1}$ according to 'type D' of the BIC model. Here again, no significant changes were observed in the fatty acid composition of the lipid extracted in respect to the previous results.

Pretreatment 4: Polar solvents, e.g., alcohols, are likely to allow disrupting higher degrees of interaction of lipids with other biopolymer molecules containing hydrogen bonds (COOH , NH_3 , and polar functional groups of proteins) than non polar solvents such as hexane or chloroform, as pointed out by our previous Soxhlet extractions. In this work, the complex DMCS was wetted with ethanol (30% by mass fraction of alcohol), let in contact with ethanol overnight, and then ethanol was evaporated in a rota-evaporator at 60°C . The material was then milled using a knife grinder before extraction. Results of this pretreatment are seen in Fig. 6, and reveal an important impact since an initial output fluid phase composition of $2 \text{ g of lipids/kg of CO}_2$ is observed. This increment indicates the occurrence of free-oil. So, 'type A' of the BIC model was used in this case to fit the experimental data, using the value of the thermodynamic solubility $y_s = 25 \text{ g of lipids/kg of CO}_2$, as given by Cocero and Calvo [13]. Thus, a low value of the external volumetric mass transfer coefficient ($k_f a_0 = 0.0014 \text{ s}^{-1}$, obtained in Section 4.1) was used in order to fit the first part of the experimental cumulative extraction curve. Indeed, the model was not able to fit the experimental initial output fluid phase composition when $k_f a_0$ values greater than $k_f a_0 = 0.0025 \text{ s}^{-1}$ were used to model the experimental data.

The model gave fitted parameters $r = 0.14$ and $k_s a_s = 3.0 \times 10^{-6} \text{ s}^{-1}$. The low value of the internal volumetric mass transfer coefficient, in comparison with the values found for the extraction of vegetable oils from oleaginous seeds [35], still indicates strong limitation of the internal diffusion inside the inert matrix. Conversely, the fraction of non-bound lipids in the membrane was significantly increased after this pretreatment and

ethanol actually weakened the interaction between biopolymer molecules and lipids. Fatty acid analysis of the lipids extracted revealed, after transesterification, a total amount of ester of 85% (w/w) in lipids extracted in the first part of the cumulative extraction curve. In the second period of the extraction the total amount of ester decreases to 70% (w/w). There is a clear increment in the total amount of lipids in the first part of the extraction in comparison with previous pretreatments and this could be the effect of the maceration in ethanol. On the other hand, in the second stage of the extraction, where the internal mass transfer rate control the process, the total amount of lipids diminishes at almost the same level as in previous pretreatments.

Pretreatment 5: Another common method used to facilitate extraction of yeast lipids is acid or alkali hydrolysis. This technique breaks the bonds connecting lipids to other biopolymers, causing denaturation of proteins, and inactivation of lipases, but also possible degradation of the lipids. Acid hydrolysis is one of the most employed techniques for yeast cell conditioning at laboratory scale and can be scaled up for pilot-plant operation [3].

In this study the harvested membrane complex was first submitted to acid treatment, i.e., boiled with 1 N HCl solution for 4 h and subsequently heated and dried by atomization (operations done by our provider and partner, the Lesaffre Company). This pretreatment changed significantly the physical properties of the material, such as solid density and porosity, and had an important influence on the cumulative extraction curve. The 'type D' BIC model was used and yielded a fraction of free-lipids $r = 0.11$ with an internal mass transfer coefficients $k_s a_s = 2.4 \times 10^{-6} \text{ s}^{-1}$. However, in this case the final extraction yield, at a specific solvent mass ratio of 250 ($\text{CO}_2/\text{TG-free yeast, kg/kg}$), was similar to the one obtained after the thermal pretreatment at 120°C (pretreatment 1). The observed value of the initial output fluid phase composition was $y_0 = 0.13 \text{ g of lipid/kg of CO}_2$. It corresponds to a partition coefficient K equal to 0.0007 ($\text{kg TG-free yeast/kg CO}_2$) for the adsorption equilibrium, a value even lower than the one found for the extraction of untreated DMCS.

Pretreatment 6: Similar to pretreatment 5, the acid hydrolysis of the MCS was here carried out during 4 h. Then the material was washed and filtered. The wet MCS (80%, w/w, of water content)

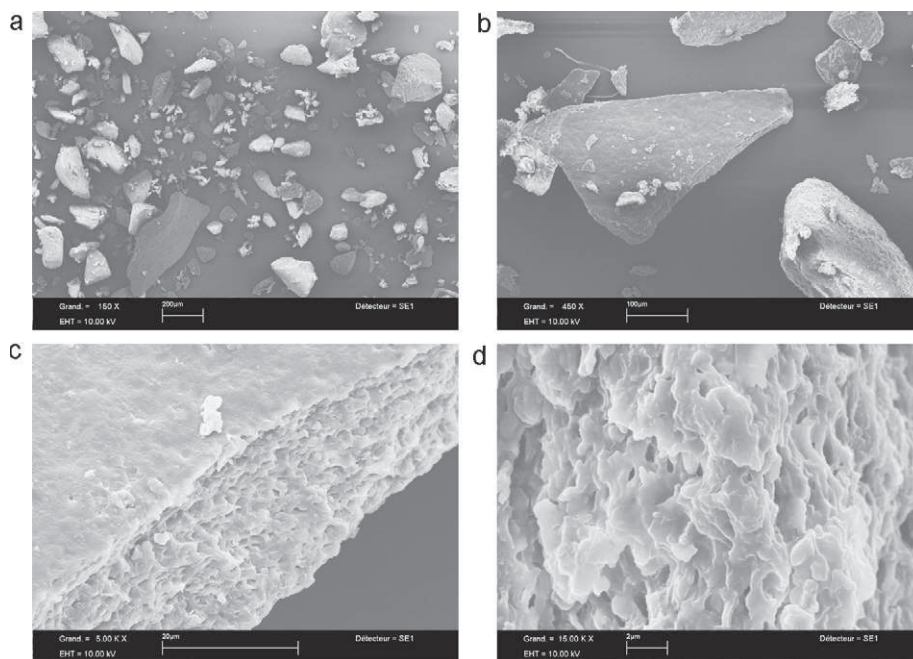

Fig. 7. SEM images of a section of DMCS subjected to acid hydrolysis and dried at 60°C overnight. (a) Irregular distribution of membrane particles. (b) General shape of the particles. (c) Zoom of the narrow phase the membranes showing a porous material. (d) Surface of the yeast membrane complex DMCS after pretreatment 6.

was then dried at 60 °C in a convection oven overnight. Finally, the material was milled using a knife grinder up to a final average particle diameter of 300 μm.

Fig. 7 shows SEM images of the complex MCS submitted to this pretreatment 6. By comparison with Fig. 5, the morphological differences of yeast complexes MCS depending on the pretreatment and the drying process are obvious. In this last case, the size and particle shapes were more irregular (Fig. 7a). Most important, the material seems to be porous, potentially allowing a much better penetration for the solvent and better contact with the lipids (Fig. 7c). Walls of the membrane appear thinner favoring a shorter path for the internal diffusion from intact to broken membranes (Fig. 7d).

From the examination of the extraction curve (Fig. 8) obtained with the lower extractor capacity (54 cm³) a value of the initial output fluid phase composition $y_0 = 3.2$ g of lipids/kg of CO₂, can be deduced and this value is one order of magnitude greater than the value found in the extraction of untreated DMCS. This pretreatment allowed the extraction of one third of the lipids in the first part of the process, corresponding to a specific solvent mass ratio of $q = 30$.

CPG analyses of the extracted lipids revealed constant fatty acid composition all along the cumulative extraction curve with a total ester fraction of 79% (w/w) after transesterification. Normalized fatty acid composition showed similar results to the ones reported in Table 3.

The extraction cylinder of 228 cm³ was employed to assess the effect of a higher residence time on the extraction yield. As it can be observed in Fig. 8, the initial output fluid phase composition was increased from 3.2 to 14 g of lipids/kg of CO₂, when the DMCS material processed was incremented from 30 g to 140 g, respectively.

As in the case of pretreatment 4, because an important initial output composition of lipids in the solvent indicated the presence of free-oil, 'type A' of the BIC model was used in this case to fit the cumulative extraction curves. The value $k_f a_0 = 0.0014$ s⁻¹ obtained in Section 4.1 was used to model the experimental data. As explained before, this model was not able to fit the first part of the cumulative extraction curve when $k_f a_0$ values greater than $k_f a_0 = 0.0025$ s⁻¹ were used.

It is important to note that the low $k_f a_0$ value used in this work when free-oil was present in the substrate could also artificially account for an inadequate description of flow pattern [22]. However, the study of the hydrodynamics inside the extraction cylinder was beyond the scope of this work and additional specific experiments would be necessary to assess this hypothesis.

With this pre-treatment, the free-oil or non-bound lipids were clearly incremented ($r = 0.32$), showing an important improvement

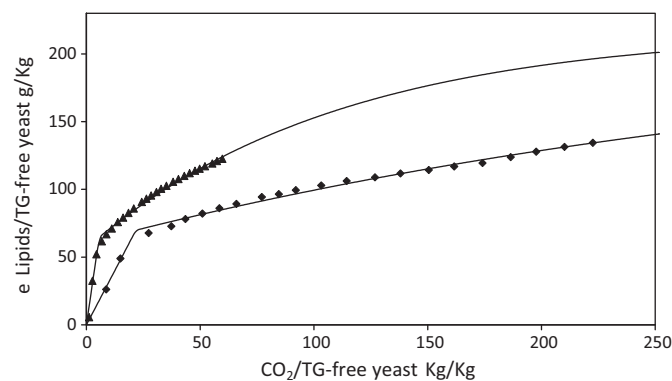

Fig. 8. Extraction from DMCS with SCCO₂ (30 g/min, 40 °C and 200 bar) and 9% (w/w) of ethanol. Material dried at 60 °C in a convection oven by 12 h. Symbols are experimental data: (♦) extraction cylinder of 54 cm³ (▲) extraction cylinder of 228 cm³. Lines: BIC model 'type A' fitting according to model parameters (r and k_s) reported in Table 8 for pretreatment no. 6 and $k_f a_0$ reported in Table 6.

in the extraction in respect to the original material and previous pretreatments. The volumetric internal mass transfer coefficient was also incremented to $k_s a_s = 1.6 \times 10^{-5}$ s⁻¹, a value more in agreement with values of internal mass transfer coefficients usually obtained in the SCCO₂ extraction of oilseeds [35]. The increment of processed quantity, from 30 g to 140 g, barely modified the fitted parameters, the fraction of broken cells r being equal to 0.3, and the value of the volumetric internal mass transfer parameter; $k_s a_s$ to 1.3×10^{-5} s⁻¹.

Pretreatment 7: Acid hydrolysis of DMCS followed by methanol maceration was performed. It is seen in Table 8 that this pretreatment results in an important increment of free-oil or non-bound lipid ratio ($r = 0.47$), influencing strongly the first part of the extraction. However, the influence of alcohol maceration in the pretreatment was not reflected in the value of final yield because internal mass transfer was still limiting the extraction, as shown by the value of the coefficient $k_s a_s$ obtained according to 'type A' of the BIC model. This value was lower than the one obtained after the acid pretreatment during 4 h (see pretreatment no. 7 in Table 8).

Methanol and drying pretreatments seemed to open the corrugated membranes, favoring the lipid extraction. Polarity of ethanol also helps to weaken interaction of lipids with biopolymers [3] increasing initial output fluid phase composition observed in the cumulative extraction curves. On the other hand, the cooking process at high temperatures barely improves results showing that high temperature provokes proteins to coagulate, leading to more dense particles; however, lipids are not free or condensed in droplets as it usually happened in oilseed extraction processes [37].

BIC model parameters reported in Table 8 are indicating severe internal mass transfer limitations for pretreatments using high temperatures, like cooking process at temperature above 100 °C and drying by atomization, where $k_s a_s$ values around 10^{-6} s⁻¹ were found.

The increase of parameter r could be the result of the milling pretreatment and of a chemical attack over the yeast material structure. For example, acid hydrolysis has been used as a pretreatment for lignocellulosic material in the ethanol bioprocesses [39]. When lignocellulosic material is submitted to acid hydrolysis, hemicellulose is totally or partially hydrolyzed into oligomeric and monomeric sugars [39]. Acid hydrolysis could have the same effect on the yeast membrane complex producing a greater fraction of non-bound lipids in the material after the pretreatment.

Generally, results are suggesting that heating at high temperature (>100 °C) and drying process by atomization of material DMCS is not appropriate as a pretreatment for SCCO₂ extraction (with or without ethanol as a co-solvent). This could be the result of incomplete elimination of water which proved to have prejudicial effects in this case [12], because agglomeration of proteins encapsulates the lipids. On the other hand, the drying process at 60 °C produces a high porosity material with greater mass transfer rates. Acid hydrolysis or alcoholic maceration seems necessary in order to obtain free lipids to extract. A high selectivity and solvent power were obtained when working at the selected operating conditions (40 °C and 20 MPa—9% of ethanol) and appropriate pretreatments, but with internal mass transfer limitation, similar to the one encountered in SCCO₂ extraction of vegetable oils [35]. The fatty acid analysis of the lipids obtained from the extraction with pure CO₂ (20 MPa and 40 °C) of the complex DMCS submitted to pretreatment 6 showed a total amount of 95% (w/w) of fatty esters. However, only 2.5% of the total extractable lipids were obtained (5 g of lipids/200 g of total lipids). So, further increments through triglycerides selectivity could be obtained by extraction and fractionation with pure CO₂ of the lipids previously obtained by CO₂ + ethanol, where initial selectivity is near 90% in respect to triglycerides.

5. Conclusions

Extraction of lipids from membrane complex of *S. cerevisiae*, using SCCO₂ + ethanol as a co-solvent, has been carried out at 20 MPa and 40 °C. Conventional organic solvent extractions using a Soxhlet apparatus were also performed. Extraction of the membrane complex with chloroform/methanol solvents yielded a lipid content of 21–23% by mass fraction of material, with a 30% of these lipids being insoluble in acetone. When the lipids obtained by Soxhlet extraction were subjected to SCCO₂ + ethanol (9%) a selective extraction of the TG was obtained, as expected according to the low solubility of PL at these operating conditions. The SCCO₂ extraction revealed strong interaction between the lipids to extract and the raw material. Besides, it was observed that the performance of the SCCO₂ extraction of the membrane complex depended markedly on the pretreatment of the material and drying process determined the success of the TG extraction. An acid hydrolysis followed by a drying process at low temperature (60 °C) was considered as the best pretreatment and yielded a 30% of non-bound lipid fraction and internal mass transfer coefficients in the same order of magnitude than those obtained in the SCCO₂ extraction of vegetable oils.

Finally, SCCO₂ extraction of TG from yeasts can be performed selectively with a 9% of ethanol as the co-solvent at 20 MPa and 40 °C and gave a residual material rich in PL, which could be extracted after this first stage by increasing the pressure or by an increase of the ethanol composition.

Acknowledgments

The authors would like to thank the French Agence Nationale de la Recherche (ANR) for its financial support to this research through the LIPICAERO project, and one of the partners, the Lesaffre Group, for providing the membrane complex of *S. cerevisiae*, used in this work.

Appendix A.

In this section it is presented the general mathematical modeling approach used in this work where the spatial term ($\partial y/\partial z$) has been represented by finite differences ($\Delta y/\Delta z$), so the reader can be familiarized with parameters and terms given in the article. The general model is well presented by Sovová [22] and most of the expressions given in this Appendix are based on this article, where the reader is referred for further details and derivations.

The differential mass balance equations in the solvent phase (1) and solid particles (2 and 3) according to Sovová's model are:

$$\rho_f \varepsilon \left(\frac{\partial y}{\partial t} + U \frac{\partial y}{\partial z} \right) = k_f a_0 \rho_f (y^* - y) \quad (1)$$

$$r \rho_s (1 - \varepsilon) \frac{\partial x_1}{\partial t} = k_s a_s (x_2 - x_1) - k_f a_0 \rho_f (y^* - y) \quad (2)$$

$$(1 - r) \rho_s (1 - \varepsilon) \frac{\partial x_2}{\partial t} = -k_s a_s (x_2 - x_1) \quad (3)$$

The initial and boundary conditions are:

$$y|_{t=0} = y_s; x_1|_{t=0} = x_{1,0}; x_2|_{t=0} = x_{2,0}; y|_{z=0} = 0 \quad (4)$$

In Eqs. (1)–(3): y , x_1 and x_2 are the composition of oil in the solvent phase, in the broken cells and in the intact cells, respectively; t is the extraction time; z , is the axial coordinate, U , is the interstitial fluid velocity; r , is the fraction of broken cells or non-bound lipids; ρ_f and ρ_s are the densities of SCCO₂ and solid particles, respectively; ε is the void volume fraction of the bed, a_0 is the specific particle external surface ($a_0 = 6(1 - \varepsilon)/d_p$, where d_p is the average particle diameter), a_s is the specific area between the regions of intact and

broken cells, k_f is the external mass transfer coefficient, k_s is the internal mass transfer coefficient, which globally accounts for the internal diffusional resistance using the linear driving force model approach, and y^* is the fluid phase composition at equilibrium with the solid phase. In the BIC model the expression of y^* depends upon a transition composition, x_t . y^* is either equal to the thermodynamic solubility y_s or proportional to the oil composition in the broken cells because of an adsorption equilibrium, according to Eq. (5):

$$y^* = y_s \quad \text{for } x_1 > x_t \quad (5a)$$

$$y^* = Kx_1 \quad \text{for } x_1 < x_t \quad (5b)$$

'Type A' extraction curves are characteristic of systems without solute–matrix interaction. In this model the transition composition is $x_t = 0$, and the equilibrium fluid phase composition is the thermodynamic solubility, Eq. (5a). 'Type D' extraction curves are characteristic of a strong matrix–solute interaction and the pseudo-equilibrium present in the system is governed by Eq. (5b) from the beginning of the extraction. The maximum composition of solute in the solvent is proportional to the solute composition in the broken cells by the partition coefficient K . In this case, the initial output fluid phase composition y_0 could be much lower than the thermodynamic solubility of the solute in the supercritical solvent. The value of K in this case can be determined from the slope of the first part of the extraction curve and the fraction of broken cells from the physical properties of the material by Eq. (6):

$$y_0 = Kx_{1,0}, \quad x_{1,0} = \frac{rx_u}{r + \gamma K} \quad \text{with } \gamma = \frac{\rho_f \varepsilon}{\rho_s (1 - \varepsilon)}, \quad x_u - x_t \leq \frac{\gamma}{r} Kx_t \quad (6)$$

In Eq. (6), y_0 is the initial output fluid phase composition, $x_{1,0}$ is the initial composition of oil in the broken cells, x_u is the initial composition of solute in the solid material.

The extractor is divided in N equal parts ($N = 100$ in this work) and after the differentiation of the spatial term, Eqs. (1)–(3) take the following form:

$$\rho_f \varepsilon \left(\frac{dy}{dt} + U \frac{y_i - y_{i-1}}{\Delta z} \right) = k_f a_0 \rho_f (y^* - y_i)$$

$$r \rho_s (1 - \varepsilon) \frac{dx_{1,i}}{dt} = k_s a_s (x_{2,i} - x_{1,i}) - k_f a_0 \rho_f (y^* - y_i)$$

$$(1 - r) \rho_s (1 - \varepsilon) \frac{dx_{2,i}}{dt} = -k_s a_s (x_{2,i} - x_{1,i})$$

Initial conditions are:

$$y_i|_{t=0} = y_s; \quad x_{1,i}|_{t=0} = x_{1,0}; \quad x_{2,i}|_{t=0} = x_{2,0}$$

This set of three ordinary differential equations is solved for each i part of $N = 100$ in which the extractor has been divided.

References

- [1] O. Catchpole, J. Ryan, Y. Zhu, K. Fenton, J. Grey, M. Vyssotski, A. MacKenzie, E. Nekrasov, K. Mitchell, Extraction of lipids from fermentation biomass using near-critical dimethylether, *J. Supercritical Fluids* 53 (2010) 34–41.
- [2] J.P. Wynn, C. Ratledge, *Oils from Microorganisms* Bailey's Industrial Oil Fat Products Six Volume Set. Edited by Fereidoon Shahidi, sixth edition, John Wiley, Sons, Inc., 2005.
- [3] Z. Jacob, Yeast lipids: extraction quality analysis and acceptability, *Critical Reviews in Biotechnology* 12 (1992) 463–491.
- [4] P.T. Anastas, M.M. Kirchhoff, Origins, current status, and future challenges of green chemistry, *Accounts of Chemical Research* 35 (2002) 686–694.
- [5] E. Bogel-Lukasik, S. Santos, R.M. Bogel-Lukasik, M. Nunes da Ponte, Selectivity enhancement in the catalytic heterogeneous hydrogenation of limonene in supercritical carbon dioxide by an ionic liquid, *J. Supercritical Fluids* 54 (2010) 210–217.
- [6] E. Bogel-Lukasik, M. Gomes da Silva, I.D. Nogueira, R. Bogel-Lukasik, M. Nunes da Ponte, Study on selectivity of β -myrcene hydrogenation in high-pressure carbon dioxide catalysed by noble metal catalysts, *Green Chemistry* 11 (2009) 1847–1856.

- [7] E. Bogel-Lukasik, R. Bogel-Lukasik, M. Nunes da Ponte, Effect of flow rate of a biphasic reaction mixture on limonene hydrogenation in high pressure CO₂, *Industrial and Engineering Chemistry Research* 48 (2009) 7060–7064.
- [8] P. Bhattacharjee, R.S. Singhal, Extraction of squalene from yeast by supercritical carbon dioxide, *World Journal of Microbiology and Biotechnology* 19 (2003) 605–608.
- [9] G.B. Lim, S.Y. Lee, E.K. Lee, S.J. Haam, W.S. Kim, Separation of astaxanthin from red yeast *Phaffia rhodozyma* by supercritical carbon dioxide extraction, *Biochemical Engineering J.* 11 (2002) 181–187.
- [10] R. Mendes, Supercritical extraction of active compounds from algae, in: J.L. Martinez (Ed.), *Supercritical Fluid Extraction of Nutraceuticals and Bioactive Compounds*, CRC Press, Boca Raton, 2008 (Chapter 6).
- [11] S.R.B. Priyadarshini, A. Balaji, V. Murugan, Extraction of microbial lipids by using supercritical carbon dioxide as solvent, *Asian Journal of Chemistry* 20 (2008) 5153–5156.
- [12] G. Brunner, *Gas Extraction: An Introduction to Fundamentals of Supercritical Fluids and the Application to Separation Processes*, Steinkopff Darmstadt Springer, New York, 1994.
- [13] M.J. Cocero, L. Calvo, Supercritical fluid extraction of sunflower seed oil with CO₂-ethanol mixtures, *Journal of the American Oil Chemists Society* 7 (1996) 1573–1578.
- [14] N.T. Dunford, F. Temelli, Extraction of phospholipids from canola with supercritical carbon dioxide and ethanol, *Journal of the American Oil Chemists Society* 72 (1995) 1009–1015.
- [15] L. Teberikler, S. Koseoglu, A. Akgerman, Selective extraction of phosphatidylcholine from lecithin by supercritical carbon dioxide/ethanol mixture, *Journal of the American Oil Chemists Society* 78 (2001) 115–120.
- [16] L. Montanari, P. Fantozzi, J.M. Snyder, J.W. King, Selective extraction of phospholipids from soybeans with supercritical carbon dioxide and ethanol, *J. Supercritical Fluids* 14 (1999) 87–93.
- [17] H.K. Kiriamiti, E. Rascol, A. Marty, J.S. Condoret, Extraction rates of oil from high oleic sunflower seeds with supercritical carbon dioxide, *Chemical Engineering and Processing* 41 (2001) 711–718.
- [18] W.D. Hubbard, A.J. Sheppard, D.R. Newkirk, A.R. Prosser, T. Osgood, Comparison of various methods for the extraction of total lipids, fatty acids, cholesterol, and other sterols from food products, *Journal of the American Oil Chemists Society* 54 (1977) 81–83.
- [19] V. Vandana, M.S.L. Karuna, P. Vijayalakshmi, R.B.N. Prasad, A simple method to enrich phospholipid content in commercial soybean lecithin, *Journal of the American Oil Chemists Society* 78 (2001) 555–556.
- [20] L.N. Ceci, D.T. Constenla, G.H. Crapiste, Oil recovery and lecithin production using water degumming sludge of crude soybean oils, *Journal of the Science of Food and Agriculture* 88 (2008) 2460–2466.
- [21] S. Camy, J.S. Condoret, Dynamic modelling of a fractionation process for a liquid mixture using supercritical carbon dioxide, *Chemical Engineering and Processing* 40 (2001) 499–509.
- [22] H. Sovová, Mathematical model for supercritical fluid extraction of natural products and extraction curve evaluation, *J. Supercritical Fluids* 33 (2005) 35–52.
- [23] C.S. Tan, S.K. Liang, D.C. Liou, Fluid–solid mass transfer in a supercritical fluid extractor, *Chemical Engineering J.* 38 (1988) 17–22.
- [24] C.H. Lee, G.D. Holder, Use of supercritical fluid chromatography for obtained mass transfer coefficients in fluid–solid systems at supercritical conditions, *Industrial and Engineering Chemistry Research* 34 (1995) 906–914.
- [25] J. Puiggené, M.A. Larrayoz, F. Recasens, Free-liquid-to-supercritical fluid mass-transfer in packed beds, *Chemical Engineering Science* 52 (1997) 195–212.
- [26] H. Sovová, J. Kucera, J. Jez, Rate of the vegetable oil extraction with supercritical CO₂-II. Extraction of grape oil, *Chemical Engineering Science* 49 (1994) 415–420.
- [27] M.J. Cocero, J. Garcia, Mathematical model of supercritical extraction applied to oil seed extraction by CO₂ + saturated alcohol—I. Desorption model, *J. Supercritical Fluids* 20 (2001) 229–243.
- [28] O.J. Catchpole, R. Bernig, M.B. Bott, Measurement and correlation of packed-bed axial dispersion coefficients in supercritical carbon dioxide, *Industrial and Engineering Chemistry Research* 35 (1996) 824–828.
- [29] <http://webbook.nist.gov/chemistry/fluid/>.
- [30] R.H. Perry, D.W. GREEN, J.O. MALONEY (Eds.), *Perry's Chemical Engineers' handbook*, seventh edition, McGraw-Hill Companies, 1997.
- [31] B.E. Poling, J.M. Prausnitz, J.P. O'Connell, *The Properties of Gases and Liquids*, fifth edition, McGraw-Hill Companies, 2004.
- [32] O.J. Catchpole, M.B. King, Measurements and correlation of binary diffusion coefficients in near critical fluids, *Industrial and Engineering Chemistry Research* 33 (1994) 1828–1837.
- [33] F.A. Stüber, M. Vázquez, M.A. Larrayoz, F. Recasens, Supercritical fluid extraction of packed beds: external mass transfer in up-flow and down-flow operation, *Industrial and Engineering Chemistry Research* 35 (1996) 3618–3628.
- [34] M. Goto, B.C. Roy, T. Hirose, Shrinking-core leaching model for supercritical-fluid extraction, *J. Supercritical Fluids* 9 (1996) 128–133.
- [35] E. Reverchon, C.J. Marrone, Modeling and simulation of the supercritical CO₂ extraction of vegetable oils, *J. Supercritical Fluids* 2 (2001) 161–175.
- [36] H.E. Carterk, K. Ohno, S. Nojima, C.L. Tipton, N.Z. Stanacev, Wheat flour lipids: II. Isolation and characterization of glycolipids of wheat flour and other plant sources, *J. Lipid Research* 2 (1961) 215–222.
- [37] Fereidoon Shahidi (Ed.), *Bailey's Industrial Oil and Fat Products*, six volume set, sixth edition, John Wiley & Sons, Inc., 2005.
- [38] H.M. Lin, E.C. Chan, C. Chen, L.F. Chen, Disintegration of yeast cells by pressurized carbon dioxide, *Biotechnology Progress* 7 (1991) 201–204.
- [39] F.M. Girio, C. Fonseca, F. Carvalheiro, L.C. Duarte, S. Marques, R. Bogel-Lukasik, Hemicelluloses for fuel ethanol: a review, *Bioresource Technology* 101 (2010) 4775–4800.