



HAL
open science

Effect of the Cyclic Crack Opening-Closure during Epoxy-Curing Period of a CFRP Strengthening System Bonded on Concrete Substrate

Marc Quiertant, Claude Boulay, Laurent Siegert, Christian Tourneur

► **To cite this version:**

Marc Quiertant, Claude Boulay, Laurent Siegert, Christian Tourneur. Effect of the Cyclic Crack Opening-Closure during Epoxy-Curing Period of a CFRP Strengthening System Bonded on Concrete Substrate. Applied mechanics, 2022, 3 (1), pp. 88-102, bibliogr., graph., photos. 10.3390/applmech3010006 . hal-03531750

HAL Id: hal-03531750

<https://hal.science/hal-03531750v1>

Submitted on 18 Jan 2022

HAL is a multi-disciplinary open access archive for the deposit and dissemination of scientific research documents, whether they are published or not. The documents may come from teaching and research institutions in France or abroad, or from public or private research centers.

L'archive ouverte pluridisciplinaire **HAL**, est destinée au dépôt et à la diffusion de documents scientifiques de niveau recherche, publiés ou non, émanant des établissements d'enseignement et de recherche français ou étrangers, des laboratoires publics ou privés.



Article

Effect of the Cyclic Crack Opening-Closure during Epoxy-Curing Period of a CFRP Strengthening System Bonded on Concrete Substrate

Marc Quiertant ^{1,*} , Claude Boulay ¹, Laurent Siegert ¹ and Christian Tourneur ²

- ¹ Materials and Structures Department (MAST), Laboratory for Experimentation and Modelling for Civil and Urban Engineering (EMGCU), University Gustave Eiffel, French Institute of Science and Technology for Transport, Development and Networks (IFSTTAR), 77447 Marne-la-Vallée, France; claudepp.boulay@gmail.com (C.B.); laurent.siegert@gmail.com (L.S.)
- ² Freyssinet International & Cie, Technical Department, 91120 Palaiseau, France; chris.tourneur@wanadoo.fr
- * Correspondence: marc.quiertant@univ-eiffel.fr; Tel.: +33-1-8166-8322

Abstract: This article investigates the potential detrimental effects of cyclic load during the installation of externally bonded (EB) carbon fiber-reinforced polymer (CFRP) on a damaged reinforced concrete (RC) structure. Four RC specimens were tested in three point bending to study the consequences of crack cyclic opening-closure during epoxy-curing period. A first RC specimen (without bonded CFRP) was loaded monotonically up to failure to serve as undamaged control sample. The three other specimens were pre-cracked before being subjected to a fatigue loading procedure to simulate service condition of a damaged RC structure. Two of the three pre-cracked specimens were strengthened by EB CFRP. One specimen was repaired before the fatigue test while the other one was repaired during the fatigue test. Finally, remaining capacities of all three pre-cracked specimens were measured through monotonic bending tests until failure. It was found that, although bonding of CFRP reinforcement during cyclic load can induce some interesting features with regard to serviceability, cyclic crack opening and closing alters the cure process of epoxy located below the initial crack and decreases the effectiveness of the strengthening at ultimate state. Extended experimental studies are then needed to assess reliable safety factor for the design of repairing operations in which the bridge has to be maintained in service during CFRP installation.

Keywords: epoxy bonding; cyclic load; carbon fiber-reinforced polymer; retrofitting of RC structure



Citation: Quiertant, M.; Boulay, C.; Siegert, L.; Tourneur, C. Effect of the Cyclic Crack Opening-Closure during Epoxy-Curing Period of a CFRP Strengthening System Bonded on Concrete Substrate. *Appl. Mech.* **2022**, *3*, 88–102. <https://doi.org/10.3390/applmech3010006>

Received: 15 October 2021

Accepted: 7 January 2022

Published: 13 January 2022

Publisher's Note: MDPI stays neutral with regard to jurisdictional claims in published maps and institutional affiliations.



Copyright: © 2022 by the authors. Licensee MDPI, Basel, Switzerland. This article is an open access article distributed under the terms and conditions of the Creative Commons Attribution (CC BY) license (<https://creativecommons.org/licenses/by/4.0/>).

1. Introduction

The rehabilitation of reinforced concrete (RC) structures by externally bonded (EB) carbon fiber-reinforced polymer (CFRP) systems is readily used among other techniques in order to shorten intervention times, reduce the inconvenience for users and diminish the costs for operators [1,2]. In most of bridge repair projects, specialized companies recommend stopping traffic to intervene. If this interruption is possible, conventional strengthening techniques by epoxy-bonded CFRP involve few days curing at ambient temperature. Some quicker solutions exist, such as bonding thermosetting prepreg plates [3]. The advantage of this process is the speed of setting (30 min to 3 h depending on the materials and the surrounding conditions). The downside of these materials is their short shelf life (usually around 30 days) which is not always compatible with the load plans of facility managers and repair companies.

If the traffic cannot be interrupted, a deviation plan for heavy trucks traffic can be put in place at the same time as a neutralization of the lane directly above the intervention [4]. However, a weight-restricted bridge remains susceptible to vibrations and the effect of a maintained traffic on the mechanical efficiency of the EB reinforcement is not yet sufficiently understood. Although fatigue-induced deterioration and debonding behavior of

EB CFRP systems is the subject of many publications (for example [5–8]) and have been introduced in several design codes, there is a lack of consensus concerning the effect of traffic moving during the polymerization of the resins used for the CFRP installation.

The key points to consider when designing a repair project of a structure expected to remain in service during rehabilitation work are its mechanical conditions and all applied loads (particularly dead load and traffic load). Several works have been published to evaluate the effect of permanent load on the behavior of RC beams strengthened with EB composites (for example [9–13]). However, fewer publications are available on the effectiveness of composites bonded to the surface of structures subjected to significant transient loads during the polymerization of the bonding layer and, in the case of dry carbon sheets installed following the wet lay-up process, of the epoxy matrix.

In a large study involving different types of specimens (including steel and RC beams and strengthening with bonded steel or CFRP plates) Barnes and Mays [14] have tested RC beams strengthened by EB CFRP. Bonding of CFRP plates was carried-out without or with vibrations. In this later case, loading cycles, with a strain of 150×10^{-6} and frequency of 1 Hz, were imposed for 48 h including the polymerization period of the epoxy resin. Beams were tested under monotonic load up to failure 7 days after strengthening. It was found that the ultimate load of the vibrated beam was the same as the control beam. Considering that failure of the CFRP-plated beams was delamination of the concrete cover, authors concluded that observed failure in the concrete cover may have masked any detrimental effect of vibrations. In their paper, Barnes and Mays point out that their results are in accordance with those previously obtained at EMPA [15] where the load-bearing capacity of slabs strengthened by EB CFRP was not affected by oscillations during the curing of the adhesive.

A study conducted by Reed et al. [4], on eight half-scale beams representative of one girder of the “War Memorial Bridge” (Bartlesville, AL, USA) and tested in four-point bending did not show any reduction in bearing capacity after reinforcement by EB CFRP, whatever the cycles imposed (intensity and frequency) during the cure of the epoxy. The ruptures observed were all debonding of the composite.

Although, CFRP strengthening systems are generally installed with the purpose of rehabilitation of damaged RC structures, most of the studies of the influence of traffic-induced vibration during bonding are conducted on undamaged concrete specimens. Moreover, these studies only focus on the bonding of unidirectional CFRP pultruded plates (traditionally used for enhancing flexural capacity) while bidirectional carbon sheets are often used in rehabilitation project (for shear strengthening or confinement).

For these reasons, this study investigates the performance of a pre-cracked RC specimen strengthened with a bidirectional CFRP system installed during curing of the adhesive.

2. Experimental Program

2.1. Test Specimens

For the present study, four identical RC specimens (15 cm × 20 cm × 70 cm) with identical internal steel reinforcement were fabricated. A unique batch of concrete was used to cast beams and characterization cylinders. Mechanical properties of concrete have been measured on cylinders (16 cm in diameter and 32 cm in height) in accordance with European standards [16,17]. The cylinders were tested at the time of bending tests. Concrete properties are summarized in Table 1.

Table 1. Concrete properties.

Young’s Modulus	31.8 GPa
Poisson’s ratio	0.19
Tensile strength (from splitting tests)	3.1 MPa
Compressive strength	41.2 MPa

The specimen geometry and internal reinforcement are shown in Figure 1. These specimens, with a rather small shear span and high height-to-length ratio, were designed to induce shear-moment interaction and mixed mode (mode I and mode II) crack tip opening displacements. Specimens are referred as beams in the following as they are submitted to flexural tests. However, these are not intended to behave as classical beams (with predominant flexural or shear failure) but have rather to be considered more generally as RC specimens where a crack could open or close cyclically.

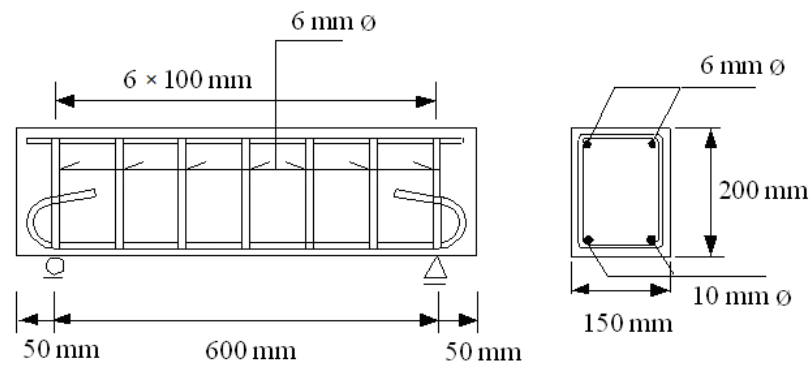

Figure 1. RC specimens' details.

The CFRP system used in this research is made of a dry bidirectional carbon fiber fabric combined with an epoxy resin, all together installed in accordance with the wet lay-up process. The two-component epoxy resin, prepared just before installation, serves as a matrix of the composite and as a bonding agent. Main properties of the adhesive are listed in Table 2 (tensile properties of the bulk epoxy was determined according to EN ISO 527-1 [18]).

Table 2. Constituents and main properties of the epoxy systems used in the present study.

	Resin Part	Hardener Part
Main organic constituents (reported by manufacturers)	Bisphenol A epichlorhydrin oxirane	Alkyletheramines Diethylenetriamine (DETA)
Hardened epoxy		
Tensile modulus (measured)	2.3 ± 0.2 GPa	
Tensile strength (measured)	29.3 ± 1.2 MPa	
Ultimate strain (measured)	2.4 ± 0.3%	

The dry sheet consists of a bidirectional fabric with 70% of fibers in the primary direction. The CFRP saturated in place contains 40% ($\pm 7\%$) volume fraction of fiber sheet in a matrix of epoxy resin. Its properties are listed in Table 3 (values are those reported by the manufacturer).

Table 3. Carbon fibers and CFRP properties.

	Fibers (12 k—Torayca) Nominal-Min	CFRP (One Layer) Average
Thickness (mm)	x	0.43
Young's modulus (GPa)	230–221	105 (wrap direction)
Tensile strength (MPa)	4900–4510	1700 (wrap direction)

Two of the four beams, labeled ES1 (for Externally Strengthened number 1) and ES2, were strengthened in flexure by this CFRP system bonded to their tension face. This strengthening configuration was chosen for the sake of simplicity in specimens' preparation. However, the case study considered in the present research was not specifically those of flexural reinforcement (usually achieved by EB unidirectional CFRP plats) but, more

generally, those where a bidirectional CFRP sheet crosses a crack path. This kind of configuration can be found for example when CFRP sheets are bonded on the sides of the beam (case of U-shape configuration, see for example [19]). The previously detailed positioning of the research explains why a mixed crack tip opening displacement is intended.

It is important to note that U-shaped layers of CFRP were used to anchor the ends of the longitudinal CFRP as shown in Figure 2. These transverse straps were installed to avoid premature failure of the concrete cover by delamination that was described in [14], as this phenomenon is potentially able to mask any detrimental effect of vibrations. The design of the U-shaped layer (location and width) was based on previous tests performed on the laboratory [20].

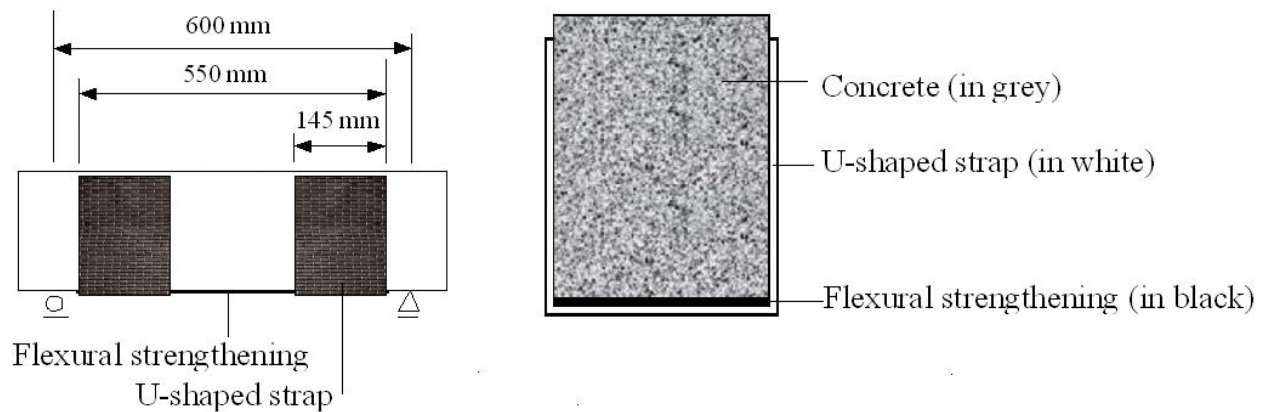

Figure 2. Details of composite strengthening scheme.

Installation of the CFRP system in ES1 was in accordance with manufacturer's instruction. The concrete surface was sandblasted before application of the first layer of resin. Then the dry carbon fiber fabric was positioned on this wet adhesive and impregnated by exerting pressure on the carbon fabric. A second resin layer was applied to complete the impregnation of the fabric. Finally, transverse straps were placed at the end of the specimen, following the same two steps before the polymerization of the previous layers of resin (the longitudinal one). Strengthening operations of the specimens ES1 and ES2 globally followed identical procedure with few differences described latter in the paper. However, their final CFRP strengthening schemes were similar and correspond to the one illustrated in Figure 2.

2.2. Test Setup

Specimens were tested in three-point bending with a span length of 600 mm. The beam had pin/roller supports at both ends. The tests were performed on a Tinius Olsen Universal Testing Machine with a 500 kN capacity. Bending tests were executed by applying displacement-controlled loading using the MTS Testware SX 4.0 software (Eden Prairie, MN, USA) to control the servo-hydraulic actuator. The test setup is illustrated in Figure 3.

2.3. Monitoring

During testing different parameters were collected. Beams were instrumented by one electrical resistance strain gauge longitudinally bonded on the middle of the soffit of the beam at mid-span (Figure 4). Strain gauges were bonded on concrete surface for not externally strengthened beams (NES1 and NES2) or on CFRP outer layer for other specimens (ES1 and ES2). One strain gauge was also bonded on each inner bars of the tension steel reinforcement. The deflection of the beam and the crack opening were also monitored at mid-span by linear variable differential transducer (LVDTs). The locations of the LVDTs and electrical strain gauges are indicated in Figure 4. The applied load was recorded with a load cell (Figure 3). The data recorded by the seven sensors were collected 500 times each second using a computerized high-speed data acquisition system.

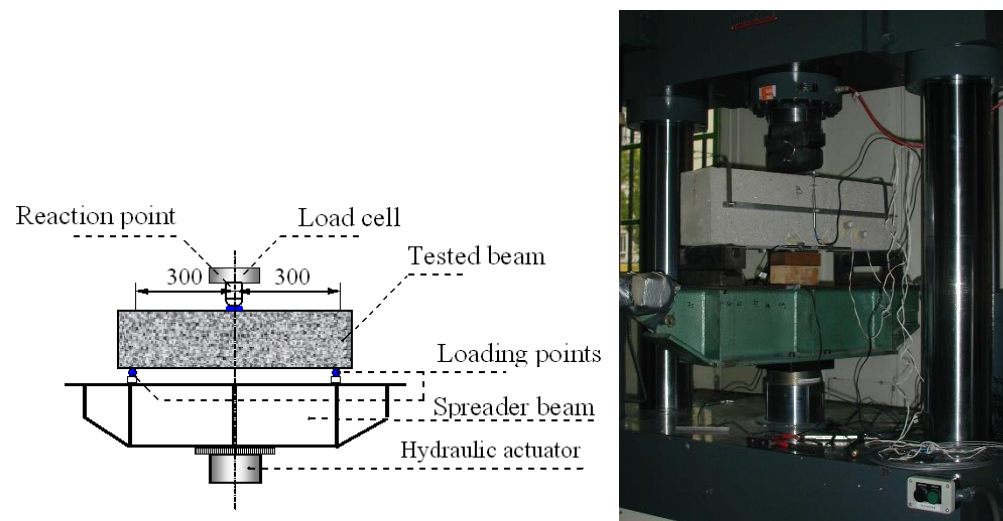

Figure 3. Three-point bending test setup.

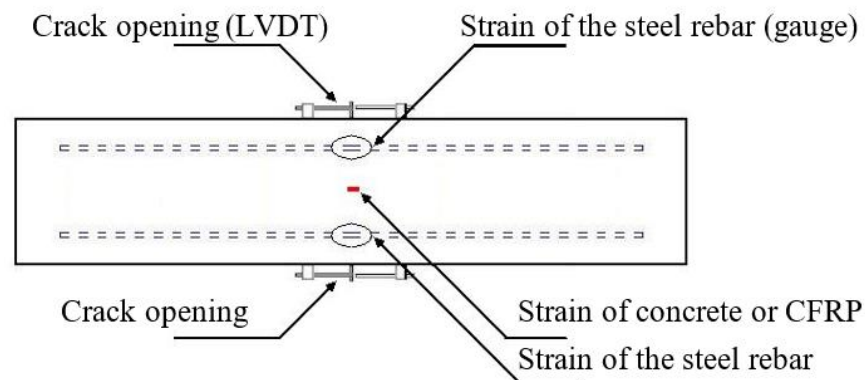

Figure 4. Instrumentation layout of the soffit of a beam (under view).

2.4. Test Procedure

The four RC beams were submitted to bending tests. The RC beams labeled NES1 (for Not Externally Strengthened number 1) and NES2 were not strengthened by EB CFRP. Beam NES1, that served as control beam, was tested in flexion monotonically up to failure. All other specimens (NES2, ES1 and ES2) were firstly pre-cracked and secondly submitted to a fatigue loading and finally loaded monotonically up to failure. Pre-cracking was operated to create a cracked concrete zone representative of a damaged part of a RC structure.

The pre-cracking phases of samples were carried out by submitting the beams to three point bending tests controlled by the mid-span deflection at a rate of 1 mm/min and considering an automatic stopping criterion corresponding to a crack opening of 0.35 mm. During tests, the crack opening was continuously calculated as the mean value of the two measurements of the two horizontal LVDTs located at mid-span on each side of the beam (Figure 4). When the criteria was reached, applied force was automatically maintained until the unloading was launch by the operator. Evolution curves of the crack opening during loading recorded in the pre-cracking phases are presented in Figure 5. For sake of comparison, the beginning of the monotonic loading of specimen NES1 is also presented in the Figure 5. In this figure, it can be noticed that the beam NES2 experimented a lower crack evolution than other specimens at the end the loading stage. The other three beams followed quite distinct crack evolutions (i.e., curves are not merged) but arrived at the targeted crack opening for a very similar loading (NES1: 48.56 kN, ES1: 50.00 kN, ES2: 49.12 kN). During the pre-cracking phases, a unique vertical crack was observed on each specimen.

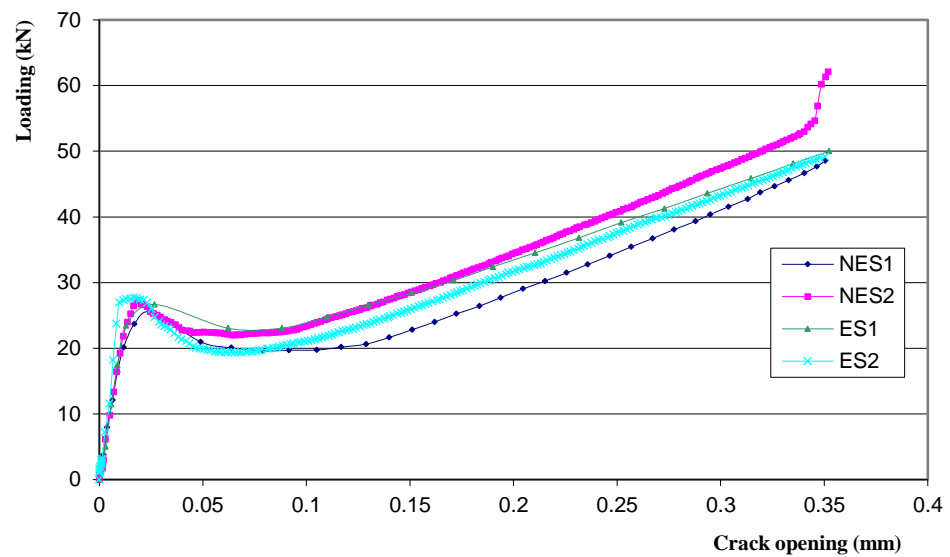

Figure 5. Evolution of the crack opening with loading during the pre-cracking phases of NES2, ES1 and ES2 and the beginning of the monotonic loading of NES1 (N.B. ES1 and ES2 were strengthened by CFRP after their pre-cracking phase).

After fatigue conditioning, the three beams were loaded monotonically up to failure to assess their remaining loading capacities. Monotonic loadings were controlled by mid-span deflection at a rate of 1 mm/min. Such loading is necessary to capture the post-peak behavior, provided the specimen fails in a rather ductile manner. It should be pointed out that all loading phases (pre-cracking, fatigue conditioning and loading to failure) were executed using the same three-point bending configuration. Fatigue load cycles, servo controlled by the measured load, were predefined to consist of applying a total of 2 million cycles. The magnitude of the load was varying sinusoidally from 40–100% of the load that was recorded for a crack opening of 0.35 mm at mid-span during the test of the specimen NES1. The value of this crack opening, intended to simulate a quite severe service condition, was achieved to the load level of 48.56 kN. The number of fatigue cycles was chosen due to a previous study of Harries et al. [21] that underlined the detrimental effect on strength enhancement of 2 million cycles of fatigue experimented on beams strengthened with EB CFRP. Others experiments confirm the degradation of CFRP-concrete interface on cycled beams [22–24].

Although it is usually assumed that the highway traffic flow can be appropriately simulated by a 1 Hz frequency load [14,24], specimens NES2 and ES1 were submitted to 4 Hz fatigue load during all the fatigue tests to shorten the duration of tests. This frequency was also applied during the second phase of fatigue of ES2 (see the fatigue test program of beam ES2 below). This higher value of frequency was adopted as it was previously used by several authors to study the behavior of RC beams strengthened with CFRP [25–28]. Considering that all cycled specimens were subjected to the same frequency of 4 Hz (except during first phase of fatigue test of ES2), it was assumed that comparison of specimen behavior between each other makes sense. Moreover, the magnitude of the cyclic load (48.56 kN), that corresponds to a severe crack opening as already mentioned, was also chosen to accelerate the potential detrimental effects of cyclic loads.

The specimen ES1 was strengthened by EB CFRP just after pre-cracking. A 7 day cure of the epoxy was achieved in the laboratory (without any moving of the specimen) before proceeding of fatigue flexural loading. For the ease of CFRP installation, the beam ES1 was lying upside down during bonding operation (i.e., the beam face subjected to tensile load during the bending test was positioned upward during bonding, see Figure 6a).



Figure 6. Strengthening of specimens: (a) beam ES1 positioned upside down; (b) CFRP strips bonded as in the field (technicians working under the beam ES2).

Fatigue test program of beam ES2 was as follow: during one week the specimen was submitted to 1 Hz fatigue bend loading (corresponding of 604,800 cycles); during this period the CFRP strengthening was installed in a configuration similar to the one that can be found on site: the beam positioned on its supports and the technicians working under the specimen (see Figure 6b). This first fatigue step of 604,800 cycles was completed, by a 4 Hz fatigue phase permitting to reach the targeted 2 million cycles. The lower frequency of the first step of the fatigue program (1 Hz) was chosen (i) to ensure a cyclic opening of the pre-existing crack reasonably representative of service load during cure of the epoxy and (ii) to facilitate the installation of the CFRP reinforcement during cycles. As ever explained, in the second phase the frequency was changed to 4 Hz in order to speed up the test.

Due to imposed frequency (1 Hz) and magnitude of crack opening-closing (max of 0.35 mm) during bonding as well as the chosen installation configuration of the EB CFRP (beam laying on its supports), the strengthening operation performed on the beam ES2 was assumed representative of field conditions that can be encountered in a RC structure that remains open to traffic while CFRP bonding.

Although positioning of the two specimens was different at the moment of CFRP bonding (ES1 laying upside down and ES2 normally positioned on its supports), it is expected that this difference may not introduce bias in the comparison of the behavior of the two strengthened specimens. Major difference is expected to come from cyclic loading during the cure of the epoxy. In other words, if an effect of positioning exists, it is expected to be less important than the one induced by cyclic loading. Indeed, it is recalled that the bonding performances of CFRP with concrete substrate is usually assessed from tests carried out on samples that are strengthened by bonding the CFRP on the concrete substrate located below: pull-out tests with CFRP bonded on the upper face of concrete slabs (see for example [29,30]), shear tests with CFRP bonded on the upper face of concrete blocks [31–33] and small beam test with CFRP bonded while the beam is upside down [20,28]. Moreover, the cyclic loading during CFRP installation was not expected to damage the CFRP/concrete bonded joint but rather to have a detrimental effect on the formation of the matrix of the CFRP material. The latter is not related to the positioning of the specimen during CFRP installation.

After the 2-million-cycle fatigue conditioning, beams NES2, ES1 and ES2 were submitted to failure under monotonic loading. The different steps of the experimental program performed on each specimens are listed in Table 4.

Table 4. Summary of the experimental program.

	Step No. 1 Pre-Cracking	Step No. 2 CFRP Bonding	Step No. 3 Cure of Epoxy	Step No. 4 Fatigue Cycles	Step No. 5 Failure
NES1	No	No	No	No	Yes
NES2	Yes	No	No	2 million cycles	Yes
ES1	Yes	Yes	7 days cure without any cycles	2 million cycles	Yes
ES2	Yes	Yes (during cycles)	7 days with 604,800 bending cycles during cure of the epoxy	1,395,200 cycles	Yes

All the experimental campaign (including RC specimen preparation, bonding of CFRP material and mechanical tests) was conducted in the laboratory with controlled temperature (20 ± 1 °C) and relative humidity ($55 \pm 3\%$ RH).

3. Test Result

3.1. Failure

As previously explained, for all beams, the experimental program was achieved by a monotonic bending test to rupture. Failure of specimen NES1 was due to tensile rupture of one longitudinal reinforcing bar (rebar) at mid-span, below the stirrup at the exact location of the first crack. At failure, the initial crack formed a largely open flexural crack. Beam NES2 experimented a similar failure mode. Specimen ES1 failed through tensile fracture of the CFRP longitudinally bonded at the soffit of the beam. The transverse tearing of the carbon sheet occurred at the crossing of the longitudinal layer with the transverse one (Figure 7a). It is to note that the CFRP U-jackets were efficient to prevent debonding at the end of the longitudinal CFRP strengthening, as expected. Before total collapse of the beam, some inclined concrete cracks propagate from the soffit and rise to the initial vertical crack. Considering their inclination (approximately 45 degrees) typical of shear cracks and the location of their initiation (at the soffit) as flexural cracks, these cracks were considered as the consequence of a mixed shear/flexural failure. The large opening of one of this shear crack triggered the tensile failure of the CFRP. Differently, no new concrete cracks appeared with increasing load of the beam ES2 that failed by tensile rupture of CFRP below the largely opened initial flexural crack (Figure 7b).



(a)



(b)

Figure 7. Observed failure modes of strengthened beams: (a) specimen ES1 (CFRP bonded without cyclic loading); (b) specimen ES2 (CFRP bonded during cyclic loading).

3.2. Carrying Capacity

Performances of the beams can be evaluated by analysis of the load-deflection behavior experimented during the last monotonic load to failure. Recorded results are plotted on Figure 8 and summarized on Table 5. However, it must be specified that curve related to

the bending test of beam ES1 is not complete as the LVDT used for deflection measurement achieved its 20 mm maximum capacity before collapse of the specimen. However, only the end of the post-peak behavior of the specimen ES1 was not captured.

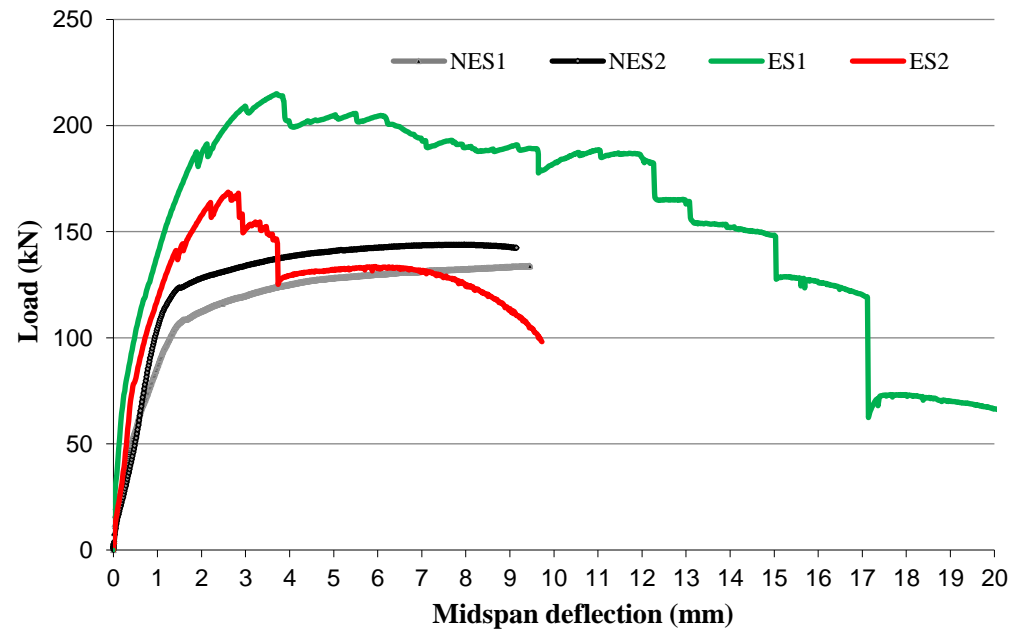

Figure 8. Load versus mid-span deflection behavior of samples under monotonic bending.

Table 5. Experimental results of the ultimate monotonic bending tests.

	Maximum Load	Failure Mode	Deflection at Failure
Beam NES1	133.7 kN	Tensile rupture of a longitudinal rebar	9.46 mm
Beam NES2	143.8 kN	Tensile rupture of a longitudinal rebar	9.16 mm
Beam ES1	215.0 kN	Tensile rupture of the CFRP due to diagonal crack	(>20 mm)
Beam ES2	168.6 kN	Tensile CFRP rupture below the initial crack	9.73 mm

From Figure 8, it can be firstly clearly noticed that despite the fatigue conditioning, the cycled beam NES2 exhibited a load-carrying capacity 7% higher than that of the control beam (un-cycled) NES1. This result indicates that no significant damage accumulation results from fatigue conditioning of NES2. This conclusion is also supported by the similar deflection at failure of the two un-strengthened specimens (NES1 and NES2).

The two specimens strengthened with EB CFRP experimented an increase in the load-carrying capacity compared to un-strengthened specimens. However, if this result was expected, it was surprising to observe that specimen ES2 failed at the same deflection than that of the two un-strengthened specimens.

4. Fatigue Behavior and Discussion on the Effectiveness of the External Strengthening

To assess the effectiveness of the bidirectional CFRP strengthening system in the tested configuration (including specimen geometry) when conventionally installed (i.e., without moving during polymerization), the Figure 9 permits to compare the evolution of the crack opening-(partial) closure recorded on beams NES2 and ES1. For each beam, two curves are presented, corresponding to crack opening at minimum and maximum cyclic loads at each cycle. Presented results clearly illustrate the well-known crack bridging effect of the EB strengthening that lowered the crack opening. In addition, it can be observed in Figure 9, that bonded CFRP also lowered the evolution of the maximum crack opening during cycles: for NES2 maximum crack opening evolves from 0.372 mm to 0.412 mm (+10.98%) while it only evolves from 0.290 mm to 0.303 mm (+4.24%) for ES1. Moreover, failure modes of

specimens previously presented (Figure 7) show that the CFRP longitudinal strengthening, involving applying a higher load to rupture, changed the failure mechanism of specimens from flexural failure (NES2) to mixed failure mode (shear and flexure failure of ES1).

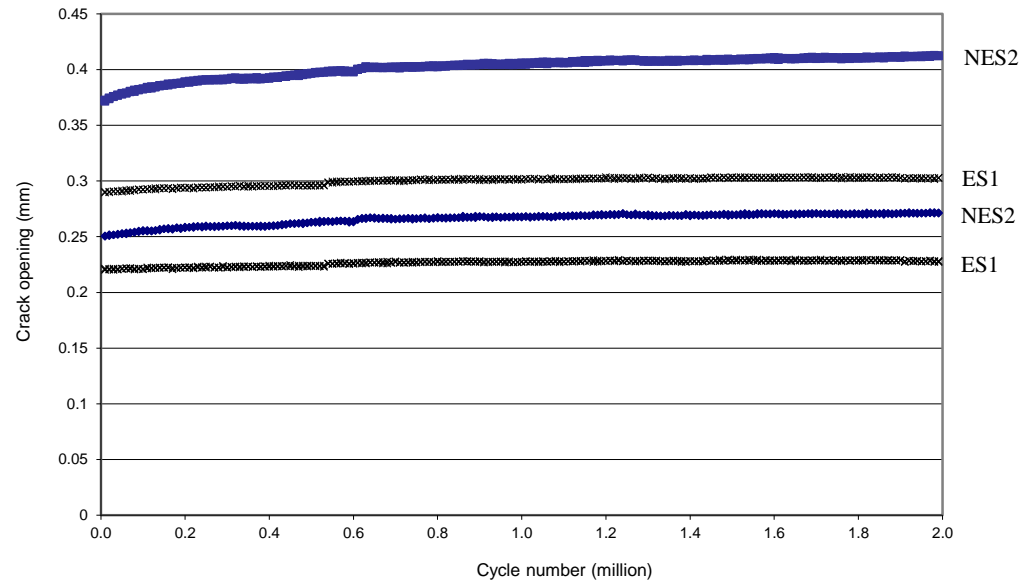

Figure 9. Evolution of crack opening extremes during fatigue tests of NES2 and ES1.

Results of the opening-(partial) closure of specimen ES2 (with CFRP bonded during cycles) are compared with those of specimen NES2 in Figure 10. As a first result, it can be observed that the extreme values of crack opening of ES2 are more important than those of NES2 during all the fatigue tests. This can be easily explained. It is recalled that all specimens were submitted to the same extreme loads (from 40–100% of 48.56 kN) during fatigue tests. However, during pre-cracking, it was observed that for a similar loading, crack opening of specimen NES2 was lower than crack opening of specimen ES2 (see Figure 5). Then, this difference in the crack opening load behavior during pre-cracking is reproduced during fatigue test. Due to this difference in the initial opening of the crack (i.e., opening of the crack at the beginning of fatigue test), it appears more relevant to discuss the evolution of the crack opening or its amplitude (defined as the crack opening at maximum load—crack opening at lower load of the same cycle, see red arrows in the Figure 10) rather than only focusing on the value of crack opening.

Considering the amplitude of crack opening during one cycle, it can be seen on Figure 10 that this amplitude is roughly the same with or without EB CFRP when the CFRP is bonded during fatigue cycles (i.e., for ES2 or NES2, respectively). However, CFRP bonded during fatigue cycles lowered the evolution of the maximum crack opening: ES2 experimented the low evolution of +4.15% (from 0.452 mm to 0.471 mm) while NES2 experimented a +10.98% evolution of its maximum crack opening (as previously mentioned).

The comparison of the load-deflection behaviors of ES1 and ES2 presented on Figure 8 clearly shows that the cyclic loading during the curing period reduced the effectiveness of the EB CFRP (considering carrying capacity). Indeed, during the first step of the fatigue cycles of ES2 (cycled during bonding), it was observed, that the cyclic opening-closing of the crack locally prevented the formation of a continuous matrix below the initial crack. Consequently, the CRFP strengthening material bridging the crack was rather a non-impregnated carbon fabric (as the matrix neither formed or directly cracked below the initial concrete crack, see Figure 11). Then the CRFP strengthening material did not locally behave as a composite material but rather as a discontinuous group of individual fibers acting without transfer loads between each other. Such behavior was leading to the premature tensile failure of the fibers below the initial crack and consequently to the collapse of the specimen ES2 while the CFRP below the initial crack of ES1 was able to

resist to higher load until the failure of the specimen. The carrying capacity of the specimen ES2 was not its only feature affected by the fatigue load during epoxy cure, as its deflection capacity was noticeably lowered (in comparison to ES1).

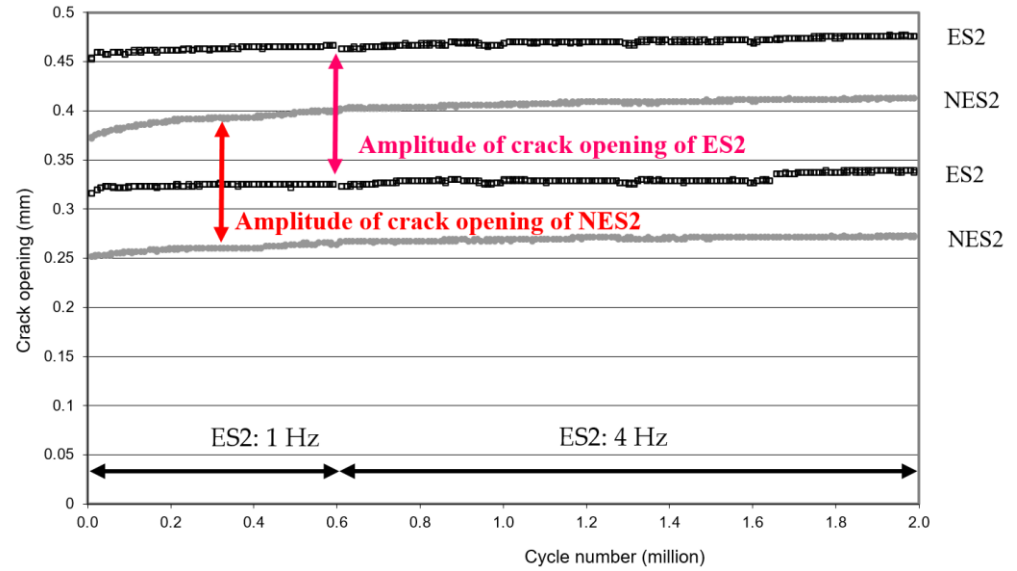

Figure 10. Evolution of crack opening extremes during fatigue tests of NES2 and ES2.

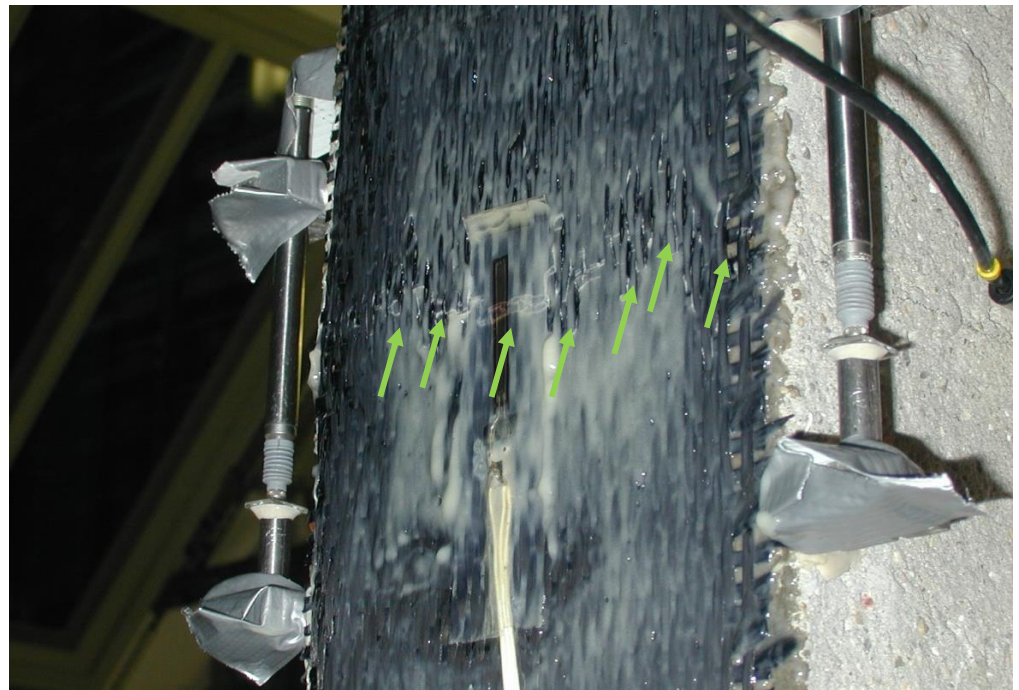

Figure 11. View of the soffit of the beam during fatigue test (green arrows indicate zones where the matrix of the CFRP is cracked).

In the Figure 12 the measurements of the two gauges bonded on steel rebars of specimen ES2 (referred as Gauge 1 and Gauge 2) are plotted. These measures correspond to extreme values recorded during the fatigue test (first phase at 1 Hz and second phase at 4 Hz). Gauge 1 was ruptured after 1.225 million cycles while Gauge 2 ruptured after 1.645 million cycles. In Figure 12, at the end of the curve corresponding of the measurement of Gauge 1 (cycles between 1.115 and 1.225 million cycles), it appears that the strain of the steel rebar has a large increase corresponding to an increase in the tensile load carried by the

rebar. Considering that the maximum load of each cycle is kept constant (48.56 kN) during cycles and that tensile forces are carried jointly by steel rebars and bonded CFRP, this probably indicates that locally the fatigue test induced a damage in the CFRP. However, it can be concluded that this mechanism was only local as neither the other gauge (Gauge 2 in Figure 12) nor the crack opening (Figure 10) evolved during this phase (i.e., cycles between 1.115 and 1.225 million cycles). Moreover, no increase in the maximum deflection during fatigue tests of ES2 was noticed at this fatigue phase (see Figure 13).

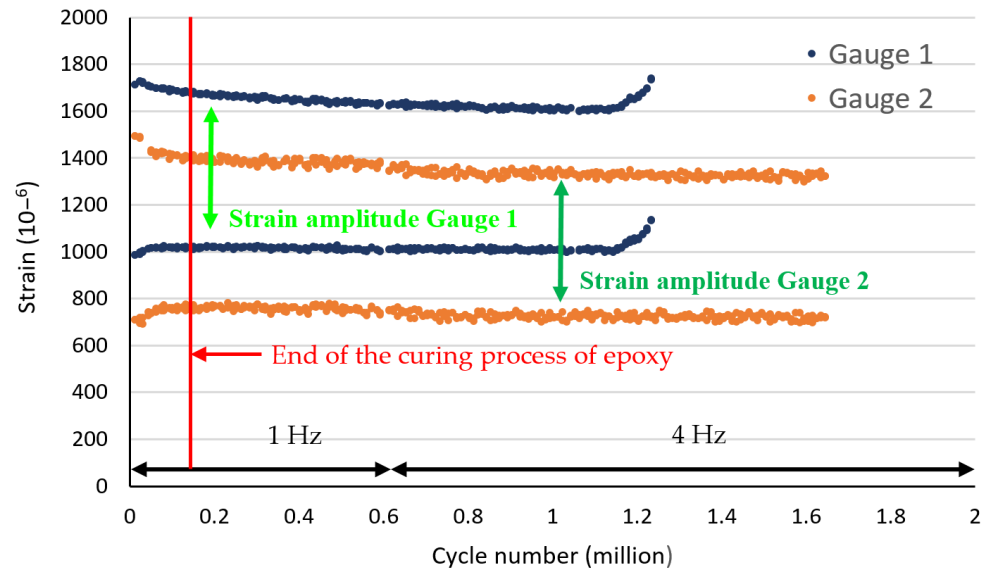

Figure 12. Strain extremes in the two steel rebars (at mid-span) during fatigue test for beam ES2.

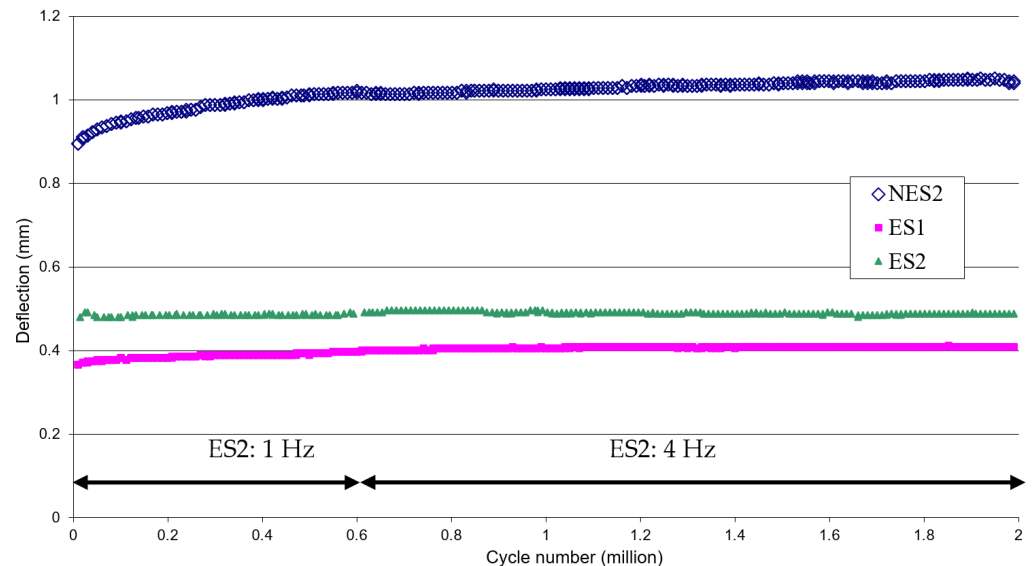

Figure 13. Evolution of maximum deflection during fatigue tests of NES2, ES1 and ES2.

Nevertheless, it can be noticed from Figure 12 that after a certain period a decrease of the longitudinal steel strain amplitude appears (defined as the strain at maximum load—strain at lower load of the same cycle, see green arrow in the Figure 12). This period of approximately two days can be linked to the curing period of the adhesive, considering that the producer data sheet indicates a full hardening of the polymer (Shore D = 70) after a 3–4 days of curing at 20 °C [34]. However, it must be indicated that if the adhesive appeared to cure in the bonded zones, epoxy just located below the crack never formed a continuous matrix, as previously described and illustrated in Figure 11. Nevertheless,

from Figure 12, it can be concluded that tensile stress, initially carried by the steel rebar, is partially transferred to CFRP when the adhesion of this external strengthening is effective.

Figure 13 shows the maximum deflection recorded during fatigue cycles (i.e., deflection at the maximum load of 48.56 kN). In this figure, it can be noticed that beams ES1 and ES2 exhibit comparable flexural stiffness while a noticeably more important deflection was experimented by specimen NES2. This result suggests that CFRP bonded during loading cycles is efficient with respect to service load (considering that it lowers the deflection).

5. Conclusions

The experimental study reported in the present paper was carried-out to study the potential detrimental effects of the service load on the effectiveness of a CFRP strengthening system bonded on a RC bridge remained open to traffic during rehabilitation.

Considering that this topic is a very complex one, with an answer depending on many parameters (initial state of the concrete substrate and particularly of the crack openings, intensity and frequency of load during rehabilitation and during service after rehabilitation, kind of structural strengthening: flexural or shear strengthening, kind of CFRP system: externally bonded pultruded plates or dry carbon fiber strips installed following the wet lay-up process, etc.), this preliminary study was then intended to identify potential detrimental effects induced by the bonding during service load to the strengthening system, and/or changes of its strengthening behavior, but not to precisely quantify the decrease in performance and related safety factor to be applied in that particular case of installation of EB CFRP.

For the previously described purpose of the research, four RC specimens were constructed and tested up to failure. The specimens were design to induce mixed mode crack tip opening displacement during cyclic bending tests. These samples and tests configuration were intended to study the influence of cyclic crack motions during the epoxy-curing period of the CFRP strengthening system bonded on the concrete substrate. Consequently, the experimental campaign was not focused on flexural behavior (flexural CFRP reinforcement, flexural tests and flexural cracks) but rather to the behavior of a bidirectional CFRP strengthening system that crosses a crack path, since this kind of CFRP systems can be bonded in different locations of a structural element (soffit or side).

The experimental program included a control RC specimen (NES1) that was loaded monotonically up to failure while the three other specimens were pre-cracked before being subjected to a fatigue loading and then finally being submitted to a monotonic bending test to failure. One of the cycled beams was not strengthened by EB CFRP strips (NES2) while a bidirectional carbon fabric was bonded on the two others (ES1 and ES2). The last strengthened beam (SE2) was submitted to cyclic load during bonding and curing while the other specimen (SE1) was strengthened without applied load.

Obtained results confirm the efficiency of EB CFRP systems when applied without cyclic deformation of the substrate to improve ductility and load carrying capacity of the specimen. Contrasted results were obtained with the beam strengthened during fatigue load. During fatigue test, considered to be severe, the two strengthened specimens exhibit rather distinct structural behavior. In ultimate state, the beam strengthened during cyclic loading (ES2) exhibits a gain in carrying capacity of 17% over the un-strengthened specimen NES2, while the other strengthened beam ES1 experimented a gain of 49%. Moreover, it appeared that the CFRP strengthening of specimen ES2 induced no gain in ductility while an important gain was observed for specimen ES1 (gain is not calculated as the ultimate deflection of ES1 is not known due to a problem with the sensor).

However, some interesting features were induced by the CFRP bonded during cycles: the evolution of the crack during cyclic tests, the tensile stress on the longitudinal rebars and deflection were all lowered compared to the values of the un-strengthened specimen NES2.

All the previously mentioned results indicate that although strengthening during cyclic load can introduce some interesting aspects with regard to serviceability, it can be concluded that the cyclic loading affects the curing process of epoxy and reduces the

effectiveness of the repairing considering ultimate limit state. Further studies are then required to confirm the trends underlined in this article and to determine conservative and reliable safety factor for the design of EB reinforcement when installed to a RC structure subjected to in-service vibration during adhesive curing.

Author Contributions: Conceptualization methodology and M.Q., C.B. and C.T.; formal analysis, M.Q. and C.B.; investigation, M.Q., C.B. and L.S.; data curation, writing—original draft preparation, M.Q.; writing—review and editing C.B.; supervision, M.Q.; project administration, M.Q.; funding acquisition, M.Q. All authors have read and agreed to the published version of the manuscript.

Funding: This research received no external funding.

Data Availability Statement: The data presented in this study are available in the article.

Conflicts of Interest: The authors declare no conflict of interest.

References

1. Yang, S.I.; Frangopol, D.M.; Neves, L.C. Optimum maintenance strategy for deteriorating bridge structures based on lifetime functions. *Eng. Struct.* **2006**, *28*, 196–206. [\[CrossRef\]](#)
2. Frangopol, D.M. Reliability deterioration and lifetime maintenance cost optimization In Keynote Lecture. In Proceedings of the First International ASRAN et Colloquium on Integrating Structural Reliability Analysis with Advanced Structural Analysis, Glasgow, Scotland, 8–10 July 2002.
3. Li, G.; Hedlund, S.; Pang, S.-S.; Alaywan, W.; Eggers, J.; Abadie, C. Repair of damaged RC columns using fast curing FRP composites. *Compos. B Eng.* **2003**, *34*, 261–271. [\[CrossRef\]](#)
4. Reed, M.W.; Barnes, R.W.; Schindler, A.K.; Lee, H.-W. Fiber-Reinforced Polymer Strengthening of Concrete Bridges that Remain Open to Traffic. *ACI Struct. J.* **2005**, *102*, 823–831.
5. Harries, K.A.; Aidoo, J.; Zorn, A.; Quattlebaum, J. Deterioration of FRP-to-Concrete Bond Under Fatigue Loading. Advances in Structural Engineering—Special Issue on Bond Behaviour of FRP in Structures. *Adv. Struct. Eng.* **2006**, *9*, 779–789. [\[CrossRef\]](#)
6. Shahawy, M.; Beitelman, T.E. Static and fatigue performance of RC beams strengthened with CFRP laminates. *J. Struct. Eng.* **1999**, *125*, 613–621. [\[CrossRef\]](#)
7. Gheorghiu, C.; Labossiere, P.; Proulx, J. Response of CFRP-strengthened beams under fatigue with different load amplitudes. *Constr. Build. Mater.* **2007**, *21*, 756–763. [\[CrossRef\]](#)
8. Guo, X.; Wang, Y.; Huang, P.; Shu, S. Fatigue behavior of RC beams strengthened with FRP considering the influence of FRP-concrete interface. *Int. J. Fatigue* **2021**, *143*, 105977. [\[CrossRef\]](#)
9. Bonacci, J.F.; Maalej, M. Externally Bonded Fiber-Reinforced Polymer for Rehabilitation of Corrosion Damaged Concrete Beams. *ACI Struct. J.* **2000**, *97*, 703–711.
10. Shahawy, M.; Chaallal, O.; Beitelman, T.E.; El-Saad, A. Flexural Strengthening with Carbon Fiber-Reinforced Polymer Composites of Preloaded Full-Scale Girders. *ACI Struct. J.* **2001**, *98*, 735–742.
11. Yeong-Soo, S.; Chadon, L. Flexural Behavior of Reinforced Concrete Beams Strengthened with Carbon Fiber-Reinforced Polymer Laminates at Different Levels of Sustaining Load. *ACI Struct. J.* **2003**, *100*, 231–239.
12. Takahashi, Y.; Sato, Y. Experimental Investigation of Initially Loaded RC Beams Bonded by CFRP Sheets. In Proceedings of the Third International Conference on Construction Materials: Performance, Innovations and Structural Implications (ConMat'05), Vancouver, BC, Canada, 22–24 August 2005.
13. Wenwei, W.; Guo, L. Experimental study and analysis of RC beams strengthened with CFRP laminates under sustaining load. *Int. J. Solids Struct.* **2006**, *43*, 1372–1387. [\[CrossRef\]](#)
14. Barnes, R.A.; Mays, G.C. The effect of traffic vibration on adhesive curing during installation of bonded external reinforcement. *Proc. Inst. Civ. Eng. Struct. Build.* **2001**, *146*, 403–410. [\[CrossRef\]](#)
15. EMPA. *Bonding of CFRP Strips under Dynamic Load-Static Testing of Prestressed Narrow Slabs Post-Strengthened with CFRP Strips*; Report No. 170'569e-1; EMPA: Dübendorf, Switzerland, 1998.
16. *NF EN 12390-3*; Testing Hardened Concrete—Part 3: Compressive Strength of Test Specimens. BSI Standards Publication: London, UK, 2003.
17. *NF EN 12390-6*; Testing Hardened Concrete—Part 6: Tensile Splitting Strength of Test Specimens. BSI Standards Publication: London, UK, 2000.
18. *EN ISO 527-1*; Plastics—Determination of Tensile Properties—Part 1: General Principles. International Organization for Standardization: Geneva, Switzerland, 1993.
19. Zhou, Y.; Zhang, J.; Li, W.; Hu, B.; Huang, X. Reliability-based design analysis of FRP Shear Strengthened Reinforced Concrete Beams considering different FRP configurations. *Compos. Struct.* **2020**, *237*, 111957. [\[CrossRef\]](#)
20. Wu, Z.Y.; Clément, J.-L.; Tailhan, J.-L.; Boulay, C.; Fakhri, P. Fatigue Test on Damaged reinforced Concrete Specimens Strengthened by Carbon Cloth. In Proceedings of the HPSC 2002, Seville, Spain, 11–13 March 2002; pp. 347–355.

21. Harries, K.A.; Reeve, B.; Zorn, A. Experimental evaluation of factors affecting monotonic and fatigue behavior of fiber-reinforced polymer-to-concrete bond in reinforced concrete beams. *ACI Struct. J.* **2007**, *104*, 667–674.
22. Ferrier, E.; Bigaud, D.; Hamelin, P.; Bizindavyi, L.; Neale, K.W. Fatigue of CFRPs externally bonded to concrete. *Mater. Struct.* **2005**, *38*, 39–46. [[CrossRef](#)]
23. Gheorghiu, C.; Labossiere, P.; Proulx, J. Fatigue and monotonic strength of RC beams strengthened with CFRPs. *Compos. Part A Appl. Sci. Manuf.* **2006**, *37*, 1111–1118. [[CrossRef](#)]
24. Macdonald, M.D. Strength of Bonded Shear Joints Subjected to Movement during Cure. *Int. J. Cem. Compos. Lightweight Concr.* **1981**, *3*, 267–272. [[CrossRef](#)]
25. Keerthana, K.; Kishen, J.M.C. Effect of loading frequency on flexural fatigue behaviour of concrete. In Proceedings of the 10th International Conference on Fracture Mechanics of Concrete and Concrete Structures (FramCoS-X), Bayonne, France, 23–26 June 2019.
26. Gussenhoven, R.; Brena, S.F. Fatigue behavior of reinforced concrete beams strengthened with different FRP laminate configurations. In Proceedings of the 7th International Symposium on Fiber Reinforced Polymer Reinforcement for Reinforced Concrete Structures (FRPRCS-7), Kansas City, MO, USA, 6–9 November 2005.
27. Wang, Y.C.; Lee, M.G.; Chen, B.C. Experimental study of FRP-strengthened RC bridge girders subjected to fatigue loading. *Compos. Struct.* **2007**, *81*, 491–498. [[CrossRef](#)]
28. Wu, Z.Y.; Clement, J.L.; Tailhan, J.L.; Boulay, C.; Fakhri, P. Static and fatigue tests on precracked RC beams strengthened with CFRP sheets. In Proceedings of the 6th International Symposium on Fiber Reinforced Polymer Reinforcement for Concrete Structures (FRPRCS-6), Singapore, 8–10 July 2003.
29. Benzarti, K.; Chataigner, S.; Quiertant, M.; Marty, C.; Aubagnac, C. Accelerated ageing behaviour of the adhesive bond between concrete specimens and CFRP overlays. *Constr. Build. Mater.* **2011**, *25*, 523–538. [[CrossRef](#)]
30. Eveslage, T.; Aidoo, J.; Harries, K.A.; Bro, W. Effect of Variations in Practice of ASTM D7522 Standard Pull-Off Test for FRP-Concrete Interfaces. *J. Test. Eval.* **2010**, *38*, 424–430.
31. Houhou, N.; Benzarti, K.; Quiertant, M.; Chataigner, S.; Fléty, A.; Marty, C. Analysis of the creep behaviour of FRP-concrete bonded assemblies. *J. Adhes. Sci. Technol.* **2014**, *28*, 1345–1366. [[CrossRef](#)]
32. Ferrier, E.; Quiertant, M.; Benzarti, K.; Hamelin, P. Influence of the properties of externally bonded CFRP on the shear behavior of concrete/composite adhesive joints. *Compos. Part B Eng.* **2010**, *41*, 354–362. [[CrossRef](#)]
33. Chataigner, S.; Caron, J.F.; Benzarti, K.; Quiertant, M.; Aubagnac, C. Characterization of FRP-to-concrete bonded interface-Description of the single lap shear test. *Eur. J. Environ. Civ. Eng.* **2009**, *13*, 1073–1082. [[CrossRef](#)]
34. Avis Technique 3/07-540. Available online: <https://evaluation.cstb.fr/fr/avis-technique/detail/3-07-540/> (accessed on 1 October 2021).