

Ammonia as zero-carbon fuel for Internal Combustion Engine: “where are we today?”

Prof Christine Mounaïm-Rousselle



Thanks to some co-workers

P. Bréquigny, A. Mercier, C. Lhuillier, B. Raitiere, R. Pelé
R. Rabello di Castro



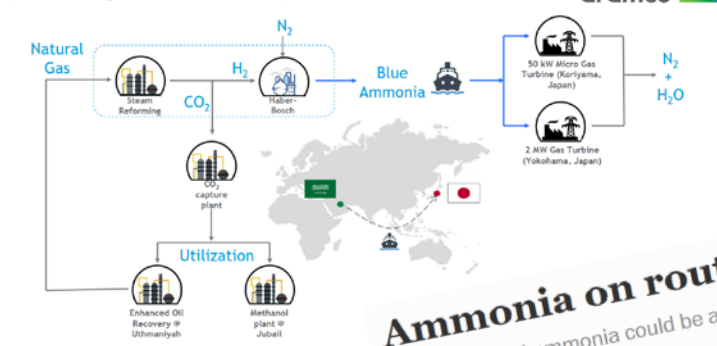

Ammonia on route to fuel ships
Carbon-neutral ammonia could be a drop-in replacement for fossil fuels

by Alex Scott
AUGUST 12, 2020 | APPEARED IN VOLUME 98, ISSUE 31



Green Car Cong
Energy, technologies, issues and policies for sustainable



Monash team proposes roadmap to renewable ammonia economy; 3 generations of technology
11 May 2020

While there is global potential to generate renewable energy at costs already competitive with fossil fuels, large scale is a challenge. Ammonia production is a current-day use substitute in transport. The potential jet fuel already a well-

Japan bets on ammonia as the fuel of the future
The pungent gas could offer the best way for the country to import renewable energy



AZO CLEANTECH About News Articles Directory Equipment

EDITORIAL FEATURE
Ammonia as a Green Shipping Fuel: The Viking Energy Project
Download PDF Copy Request Quote
By Francis Normant
May 27 2020

NEMS INSIGHT

Can Ammonia be the new carbon free fuel?

ammonia is a colourless, strong-smelling gas that forms a very alkaline solution in water which is used as a cleaning fluid. - ORIGIN first referring to a substance obtained near the temple of Jupiter in Egypt.

by iNsight

Lloyd's Register awards an Approval in Principle to EXMAR ammonia-fueled gas carrier
11 March 2021

Lloyd's Register (LR) has awarded an Approval in Principle to EXMAR for its ammonia (NH₃)-fueled 40,000 m³ Midsize Gas Carrier, a significant milestone for the progression of alternative fuels in shipping.



Siemens Tests Ammonia as a Form of Energy Storage for Renewables
The company has opened a novel new facility to study the efficiency of converting electricity to hydrogen and then to ammonia, and back.

JASMIN GREEN | June 27, 2018

The Potential Of Ammonia As Carbon-Free Fuel — Major New Research Project At The University Of Aarhus
March 22nd, 2019 by Jesper Berggreen

If You Think Hydrogen As Energy Carrier Means Trouble, Try Ammonia — New Research From Denmark Shows How



Ammonia—a renewable fuel made from sun, air, and water—could power the globe without carbon

By Robert F. Service | 2:00 PM

energy post.eu THE BEST THINKERS ON ENERGY

Post your news/event Premium Newsletter Categories

Green Ammonia can replace fossil fuel storage at scale
April 20, 2020 by Ian Wilkinson

What's the best way to store energy, from industry scale to electric vehicles, replacing the widespread use of fossil fuels? Pure hydrogen is an energy dense alternative, but the gas takes up a lot of space. Liquid ammonia doesn't, yet it contains the hydrogen and therefore the energy, Ian Wilkinson at Siemens explains the advantages of using ammonia, NH₃. Already the world produces 180m tonnes a

Ammonia: hydrogen's green soulmate?
By Davine Jansen | EURACTIV.com



The fertilizer industry produces and consumes up to 50% all the hydrogen produced every year in Europe.

A chemical traditionally used in the fertilizer industry, ammonia is in its own right, a chemical traditionally used in the fertilizer industry, ammonia is in its own right.

Is ammonia the fuel of the future?

Industry sees the agricultural chemical as a convenient and sustainable means to transport hydrogen and save carbon dioxide emissions

But establishing an ammonia fuel industry won't be easy. By most estimates, green ammonia will cost two to four times as much to make as conventional ammonia. And some of the technologies needed to harness the molecule, such as am-

WHY AMMONIA (NH₃) ?

It presents beneficial energy carrier features



Globally traded carbon-free chemical
(~180 Mt/year)

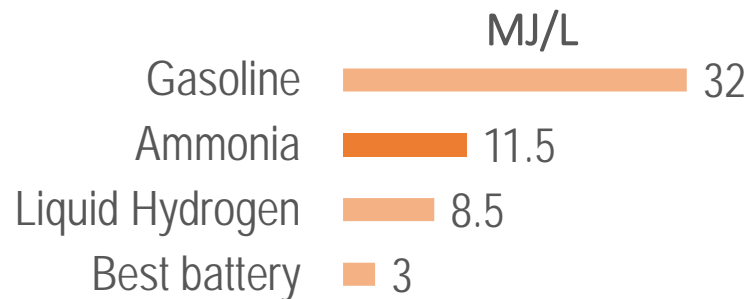

Relatively energy-dense

(€/kg _{H₂})	H ₂	NH ₃
Production	2.7	3.4
6 months storage	13.48	0.49

Cheaper than hydrogen for long-term storage

AMMONIA THE OTHER HYDROGEN



Valera-Medina et al., A review on ammonia as a potential fuel: from synthesis to economics, Open Access, Energy and Fuels, 2021

RELEVANCE OF NH_3 AS FUEL FOR ICE

RELEVANCE OF NH₃ AS FUEL FOR ICE

Fuel	Ammonia	Hydrogen	Methane	Gasoline	Diesel
Molar mass (g/mol)	17	2	16	114	167
Heat Capacity Ratio	1.32	1.41	1.32	1.4	1.4
Flammability limit (% vol.)	15.8%-28%	4% - 76%	4.4%-17%	1.4% - 7.6%	1% - 6%
Octane Number	>130	>100	130	87-93	0
Auto-ignition temperature (°C)	651	530	537	440	225
stoich. Air/fuel ratio (mass)	6	34.3	17.1	15	14.6
Lower heating value (MJ/Kg fuel)	18.8	120	50.1	42.5	45
Energy content at stoich. (MJ/kg air)	3.13	3.5	2.92	2.83	3.08
% CO ₂ emitted by stoich. Combustion	0	0	9.5	12.5	12.6*
Laminar flame speed at Patm, 100°C (m/s)	0.12	35	0.38	0.42	
Quenching distance (mm)	7	0.64	2	3	

RELEVANCE OF NH_3 AS FUEL FOR ICE

- No CO_2 , CO nor PM emissions
- Good energy density
- Potential for high compression ratios (CR)
- **Combustion promoter ?**
 - to boost performance and ensure stability

ICE fueled with AMMONIA :
Challenge !

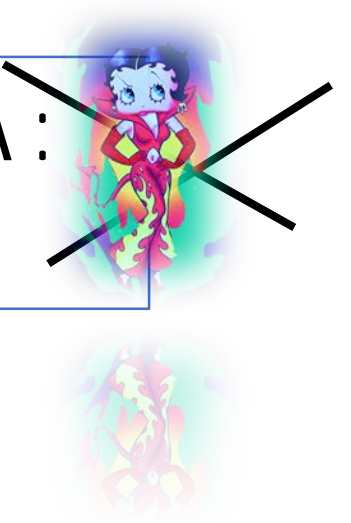

BUT

Fuel-bound nitrogen: NO_x and NH_3



- Mitigation strategy required for pollutants
 - corrosive (copper, alloy, plastic, rubber, teflon...)
 - toxic (300 ppm < air)

HISTORY : VEHICLES



1933 : Nork Hydro truck ran with ammonia



1940s
Belgium
NH₃/Coal gas
10 000 miles



2007-2012 :
Michigan University
50%NH₃/Gasoline
3 800 km



2013
Marangoni Toyota
GT-86 Eco-Explorer,

2012-2015 :
KIER, Korea
Dual Fuel
gasoline or Diesel
until 80% NH₃



2013
Università di Pisa
H₂ reformer



2020
Hydrofuel Project
(Ontario Univ.)



2018-2021
C-Free Run project,
Hydrogen Engine
Center (Iowa),

60s : theoretical studies,
CFR studies (USA)

SOME RECENT EXAMPLES : SPARK IGNITION ENGINE



CFR
Gas PFI
Gaseous DI

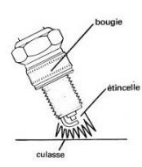

Iowa university / DTU
2012-2013
NH₃+Gasoline

Twin Lombardini
(2 cyl./0,25 l)
Gas PFI
LPG injector

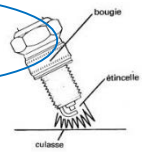

GM engine
(4 cyl/0.6 l)
Gas PFI, Gaseous DI
EMULSION

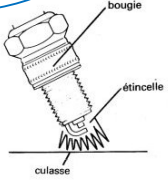

Texas university
2017
Gasoline+ethanol
(max30%)+NH₃ (17%)

Pisa University
2017
NH₃+H₂
Range Extender
1100, 2500 to 5000 rpm

Heavy duty
6 cyl./1.8l (CR10.5)
Premixed PFI

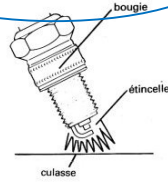

KIMM
Natural Gas + NH₃
(50%)
(Oh et al. FUEL 2021)

Toyota
4 cyl./0.9 l
Gaseous PFI
CR 9

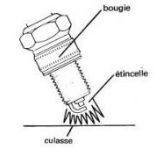

NH₃ + H₂ Thermal Reformer
cold start (0 to 1000 rpm)
with SCR catalyst
(Koike et al. IJHE 2021)

SOME RESEARCH EXAMPLES : COMPRESSION IGNITION ENGINE

Yanmar Engine /0.3 l
Liquid premixture GDI (200 b)

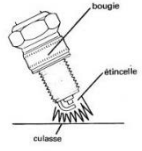

KIER
Diesel (Min 62%)/NH₃
DUAL FUEL
2014

Iowa Energy Center
DUAL FUEL
Premixed DME(min 40%) /NH₃
2014

Hyundai
3 cyl.CI engine
CR 17.5 / 0.54l



Single cylinder
research engine (0.5l)
Gas fully premixed



UCL-VRIJE –
Université
d'Orléans
NH₃+H₂
HCCI
ICE 2019

John Deere,
4 cyl. (1.125l)
CR 17



T.E. Murphy Engine Research Lab
Diesel (45% in Energy)/NH₃
DUAL FUEL + Thermal Chemical
Recuperation to blend with H₂
(decomposition)
Northop, NH₃ event 2021

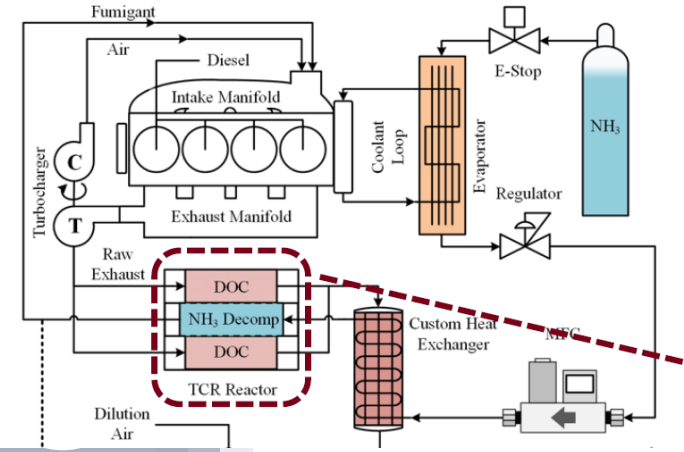

NH₃ AS FUEL FOR POWERTRAIN

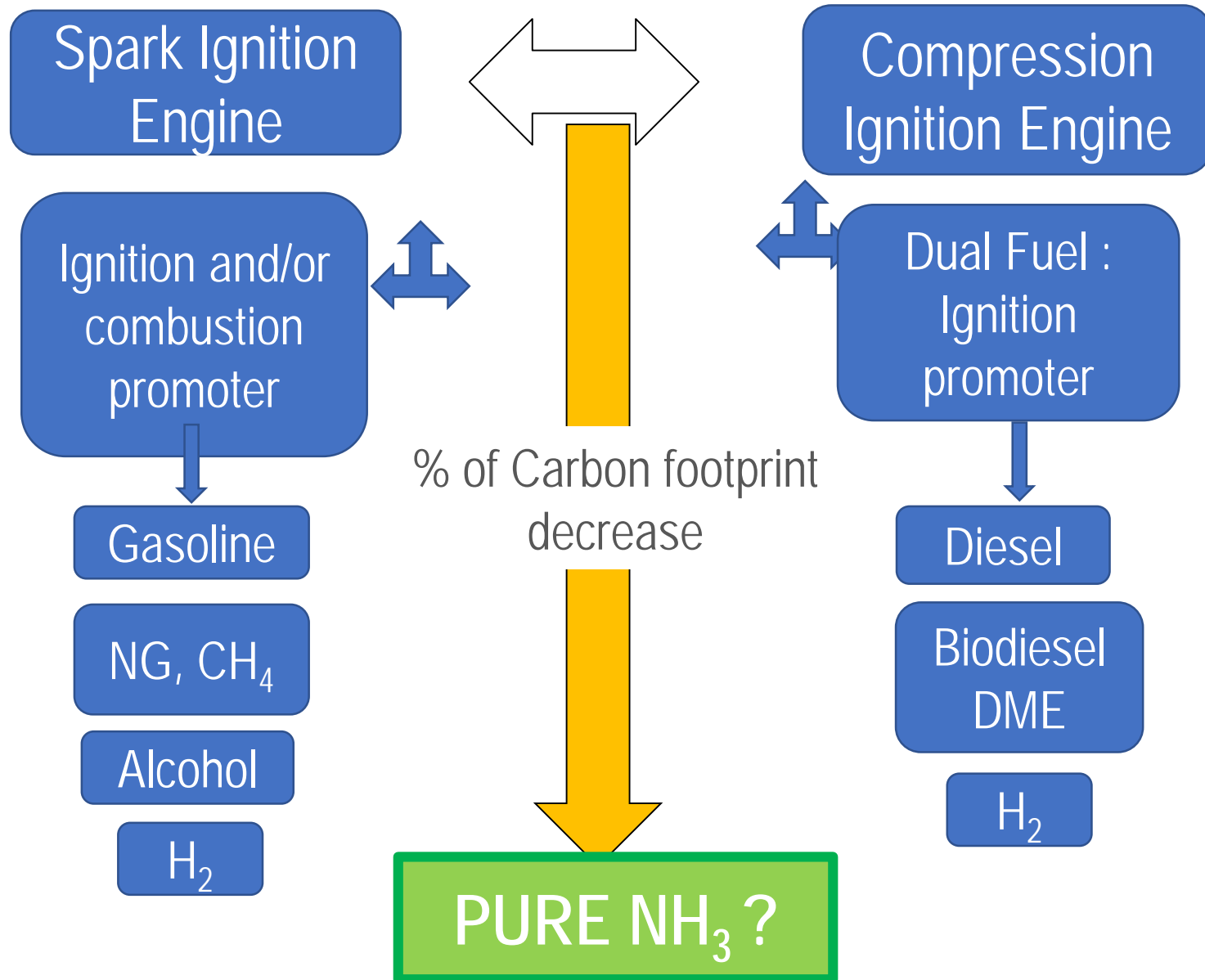

Ammonia alone ?

(12) **United States Patent**
Sasaki et al.

(10) **Patent No.:** **US 8,166,926 B2**
(45) **Date of Patent:** **May 1, 2012**

(54) **INTERNAL COMBUSTION ENGINE WITH AMMONIA FUEL**

(75) Inventors: **Shizuo Sasaki**, San Antonio, TX (US);
Jayant Sarlashkar, San Antonio, TX (US)

(73) Assignee: **Southwest Research Institute**, San Antonio, TX (US)

(*) Notice: Subject to any disclaimer, the term of this patent is extended or adjusted under 35 U.S.C. 154(b) by 599 days.

(21) Appl. No.: **12/464,636**

(22) Filed: **May 12, 2009**

(65) **Prior Publication Data**
US 2010/0288249 A1 Nov. 18, 2010

(51) **Int. Cl.**
F02B 43/00 (2006.01)
F02B 12/00 (2006.01)

(58) **Field of Classification Search** 123/1 A,
123/2, 3, 575
See application file for complete search history.

(56) **References Cited**

U.S. PATENT DOCUMENTS

6,073,862 A * 6/2000 Touchette et al. 239/408
6,936,363 B2 8/2005 Kordesch et al.

* cited by examiner

Primary Examiner — Noah Kamen

(74) *Attorney, Agent, or Firm* — Grossman, Tucker et al

(57) **ABSTRACT**

The invention provides methods of providing fuel to an internal combustion engine, fuel systems for an internal combustion engine and a fuel injector for an internal combustion engine. Ammonia may be heated and pressurized to a selected condition and may used as fuel which is supplemented with hydrogen to assist with ignition, flame propagation, and/or combustion speed.

MAIN RESULTS FROM PREVIOUS SI ENGINE STUDIES FUELLED WITH AMMONIA WITH HELP OF H₂

Combustion and Performances in SI engines				
Minimum H ₂ for combustion stability	Efficiency			Output energy
Between 5-10% in vol	Higher for ER>=1			Less than gasoline at low and partial load
Amount needed decreases with load increase (full load: 0%)	Higher than gasoline			Increase with CR or boosted pressure
slight effect of engine speed	Decrease with H ₂ increase			
Pollutant Emissions before any aftertreatment device				
	ER decrease (lean)	ER increase (rich)	H ₂ increase	Load
NOx (ppm)	++ maximum > gasoline	--	+	slight increase but no universal trend
Unburnt NH ₃	--	++	-	no universal trend
			H ₂ at exhaust	

→ Only one study (Frigo et al., small engine)

SOME RECENT HIGHLIGHTS OF COMBUSTION PROCESS IN SINGLE-CYLINDER 'CURRENT' ENGINES

AMMONIA IN 'GDI' ENGINE

Engine Characteristics	
Engine Type	Current PSA EP6DT
Bore	77 mm
Stroke	85 mm
Connecting Rod Length	138.5 mm
Displacement Volume V_{cyl}	395.81 cm ³
Compression Ratio	10.5

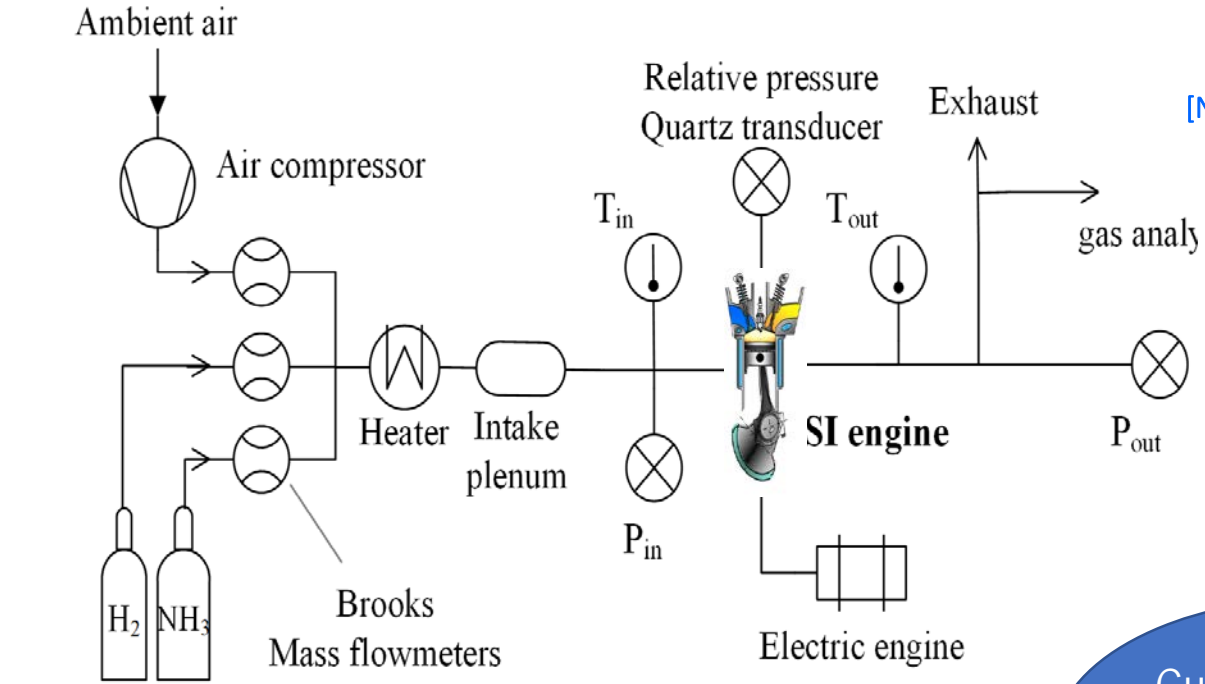

[H₂O], [NH₃],
[NO], [NO₂], [N₂O]
@ 180 °C (wet)
FTIR

[O₂], Paramagnetic
[H₂], Thermal
conductivity analyser
@ 50°C, Dry gases

Premixed gaseous NH₃/air intake (no injector)



Piston geometry (GDI)

Current igniter, CR, piston geometry (GDI)

PERFORMANCE OF THE SI ENGINE: WORK OUTPUT

Net Indicated Mean Effective Pressure

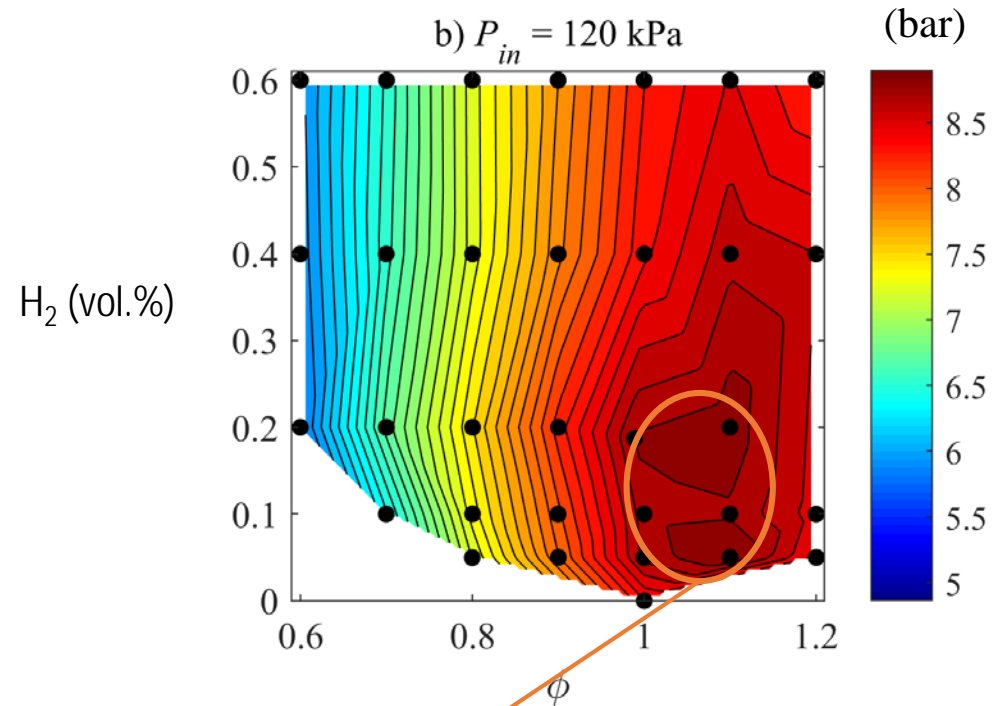

Best work for slightly rich mixtures
and 5-20 vol.% H₂

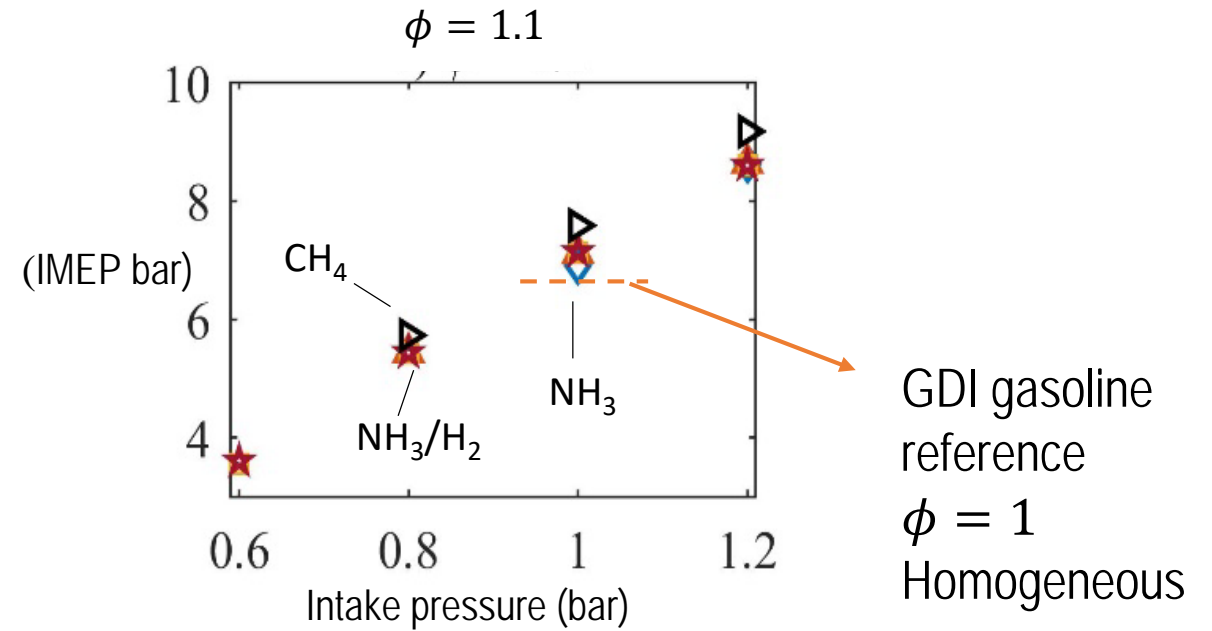

Neat NH₃ operation achievable for $P_{in} \geq 1$ bar and
 $\phi = 0.9 - 1.1$
H₂ = efficient combustion promoter

PERFORMANCE OF THE SI ENGINE: EFFICIENCIES

Indicated efficiency

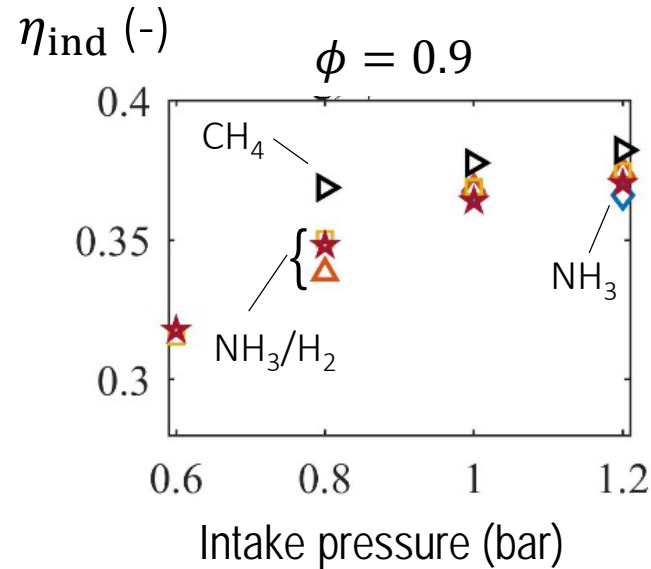
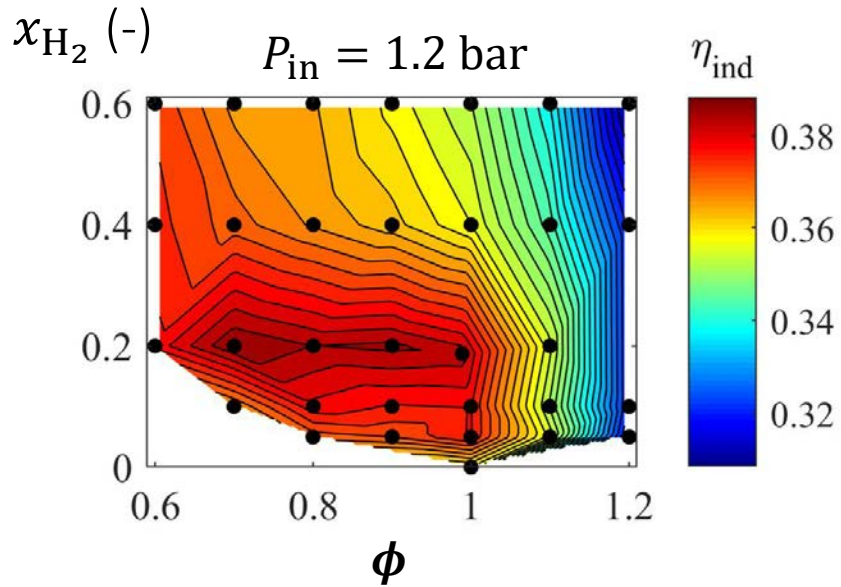

Combustion efficiency

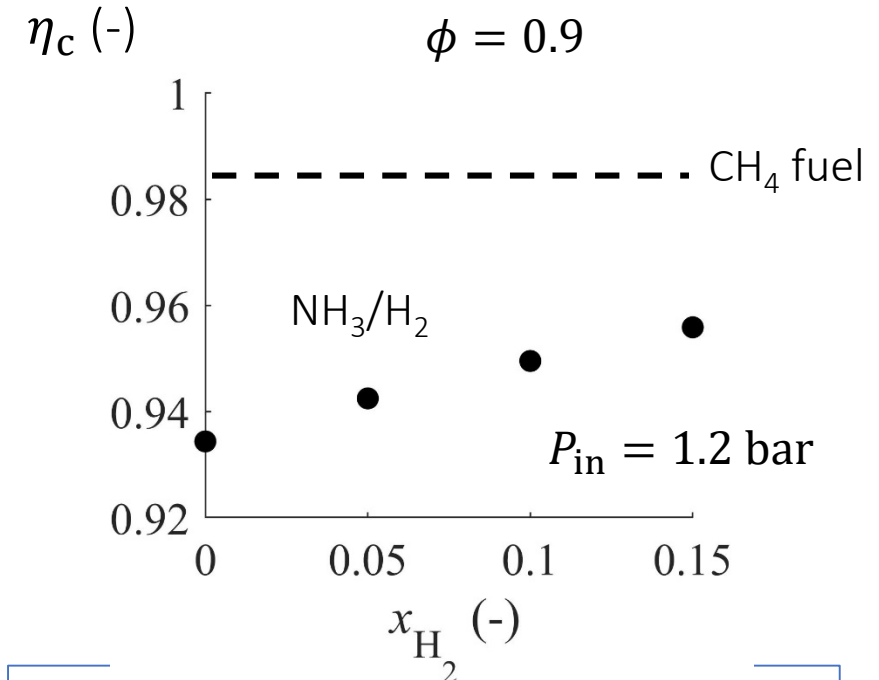

Best indicated efficiency:
 $\phi = 0.7 - 0.9$ and $x_{H_2} = 5 - 20 \%$
 with P_{in}
 Close to CH_4 ($\geq 38\%$)

Combustion efficiency depleted
 VS methane
 with x_{H_2}

EMISSIONS OF SI ENGINE FUELED WITH NH₃/H₂

Exhaust emissions
(ppmvw)

$P_{in} = 1.0 \text{ bar}$

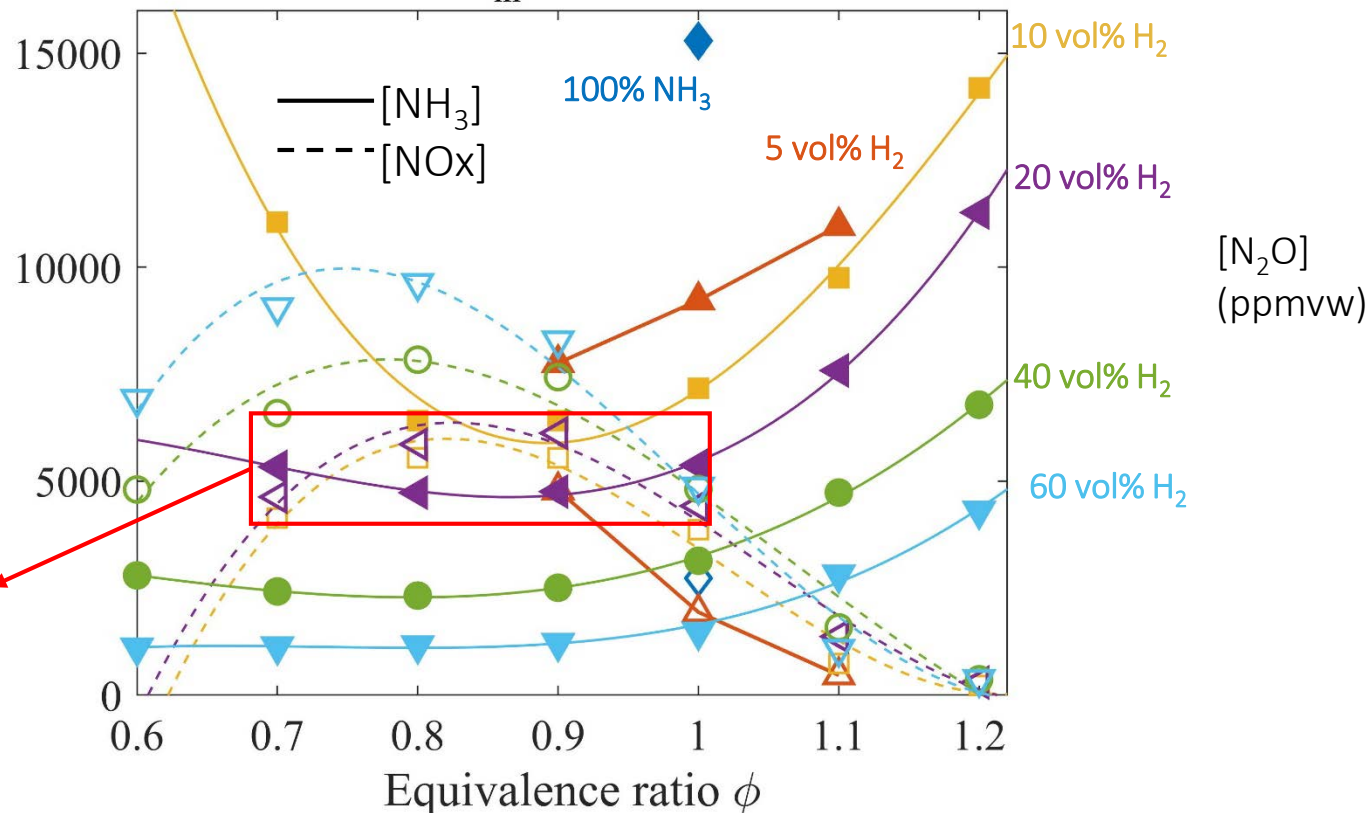

“Low” emission window

$$0.7 < \phi < 1$$

$$5\% < x_{H_2} < 20\%$$

$$\frac{NO_x}{NH_3} \sim 1 \text{ (SCR/SNCR)}$$

$$T_{\text{exhaust}} = 700\text{-}800 \text{ K}$$

Pollutants require after-treatment
(not unlike conventional fuel operation)

WHAT MINIMUM LOAD ? WITH PURE AMMONIA

□ Engine speed effect - stable conditions ($\sigma_{IMEP} \leq 5\%$)

		650 rpm			1000 rpm			1500 rpm			2000 rpm		
		%H ₂											
Φ	P _{in} (bar)	0%	5%	10%	0%	5%	10%	0%	5%	10%	0%	5%	10%
0.9	≤ 0.65			X			X			X			X
	0.8-0.85		X	X	X	X	X		X	X			X
	1		X	X	X	X	X	X	X	X		X	X
1	≤ 0.65			X		X	X			X			X
	0.8-0.85	X	X	X	X	X	X		X	X		X	X
	1	X	X	X	X	X	X	X	X	X		X	X
1.1	≤ 0.65			X		X	X			X			X
	0.8-0.85	X	X	X	X	X	X		X	X		X	X
	1	X	X	X	X	X	X	X	X	X		X	X

*optimized ignition timing (around 40-35 CAD BTDC)

- impossible to ignite at low and high rpm **without H₂**
- **difficult at low load or at high rpm**
- possible 'sometimes' to ignite with NH₃ only at naturally aspirated conditions



STELLANTIS

areNH₃ <https://arenha.eu/>

EXTENSION OF 'LOW' OPERATING LIMIT

□ Unique Solution : Increase the CR !

- Gray et al. 1966 : 'extremely CR : above 35:1 for 'Auto-Ignition
- Garabedian and Johnson, 1965 : conversion of CI engines to spark ignition mode is the 'prominent short-term solution' due to the higher compression ratio than in SI engine.
- Pearsall and Garabedian, 1967 : a 16:1 was found as the optimum to run with neat ammonia.
 - unique previous study about Ammonia-only Spark-Assisted Compression Ignition (SACI) engine.
 - Conclusion :
 - *'large bore, more concentrated combustion chamber, more centrally placed spark plug are preferable to optimize the efficiency and therefore decrease the specific fuel consumption'.*

670947

Combustion of Anhydrous Ammonia in Diesel Engines

Thomas J. Pearsall
Continental Aviation and Engineering Corp.

Charles G. Garabedian
U. S. Army-Tank Automotive Command

EXTENSION OF 'LOW' OPERATING LIMIT

- Solution : Increase the CR
 - 'Diesel' Engine with a Spark Plug

Engine Type	Current PSA EP6DT	SACI PSA DV6
Displacement Volume V_{cyl}	400 cm ³	400 cm ³
Compression Ratio	10.5	14 to 17
Valves	4	2
Tumble ratio	2.4	
Swirl ratio		2

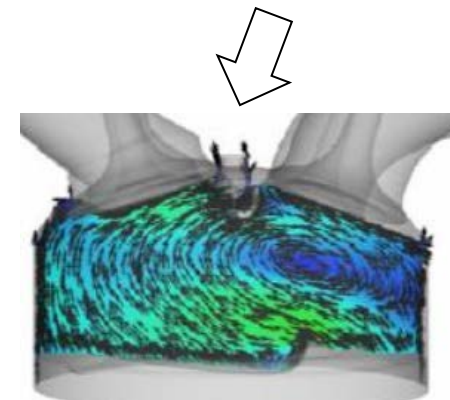

SI

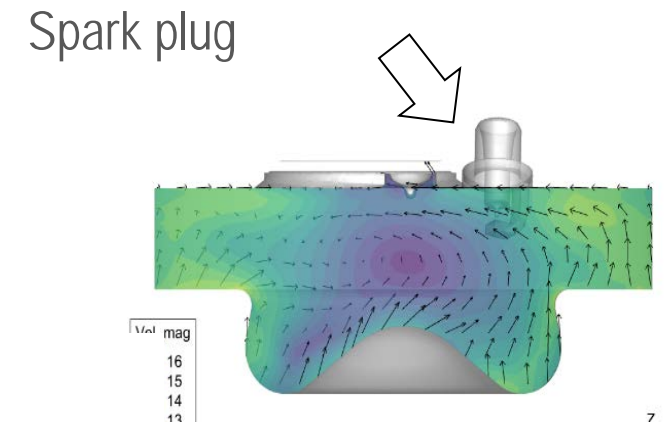

SACI

*No optimization of ignition system or location



areNH₃

STELLANTIS

<https://arenha.eu/>

EXTENSION OF 'LOW' OPERATING LIMIT

□ Increase of CR :

➤ SACI versus SI engine

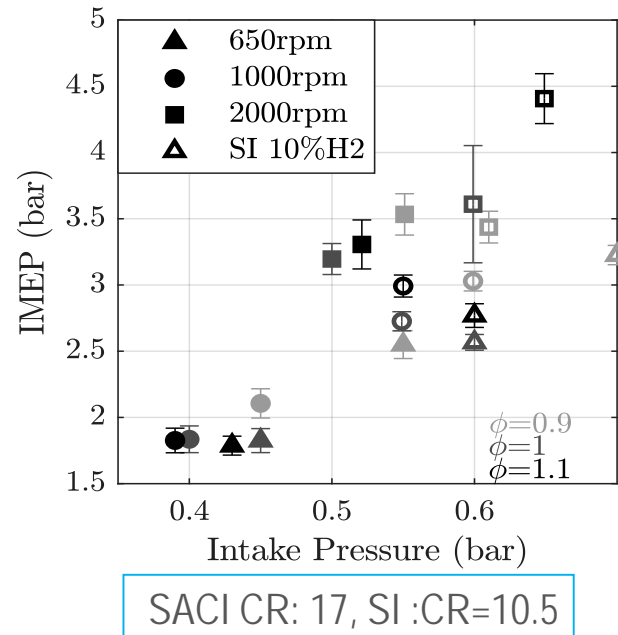
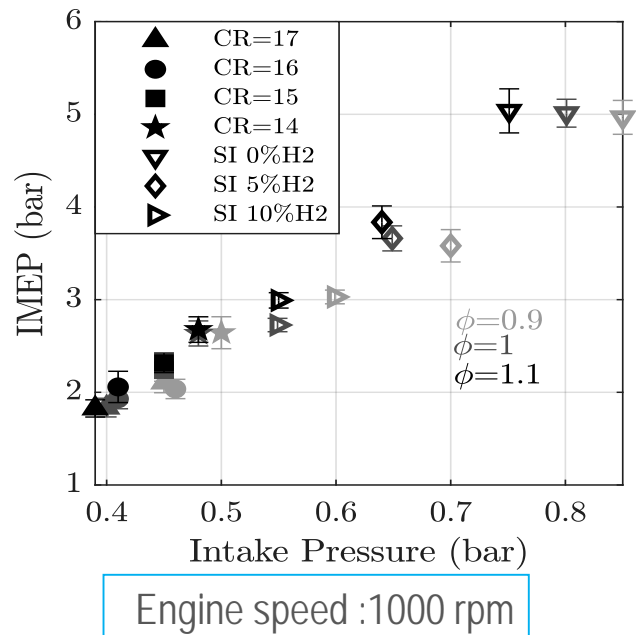

- Good improvement of NH₃ combustion with CR increase despite of flow field
- No H₂ needs
- Extension of low load limits
 - 1.7 b IMEP (as Koike et al. with Reformer)
 - CR 17, 650 rpm,
 - lower limit with slightly rich



STELLANTIS

areNH₃a

<https://arenha.eu/>

FLAME DEVELOPMENT : SACI VERSUS SI

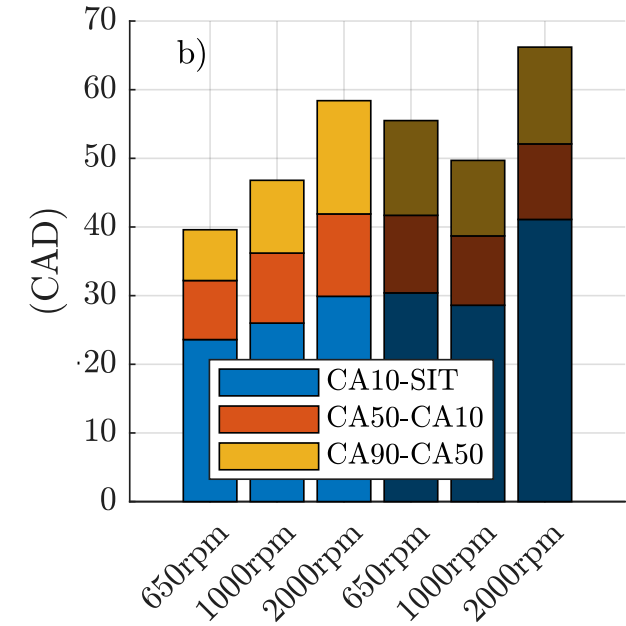
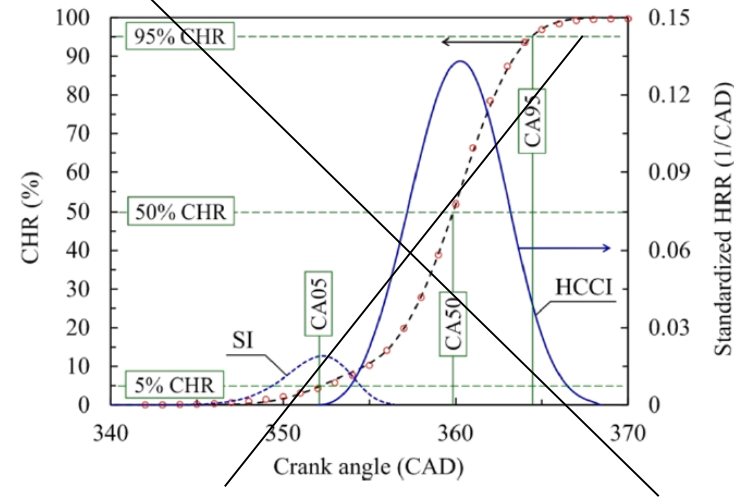
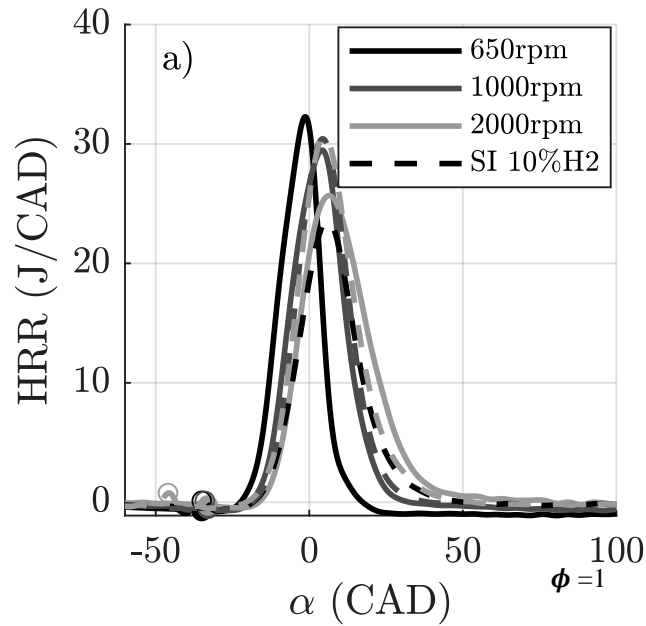

- SACI combustion mode :
 - Without H_2
 - Not 2 identified phases of HRR
- Faster first phase than SI engine
 - Pressure effect ?
 - FULLY PREMIXED PROPAGATION 'without turbulence' ?

FIRST VISUALISATION OF AMMONIA FLAME PROPAGATION IN ICE

Engine Type	Current PSA EP6DT	SACI PSA DV6	Optical DW10
Displacement Volume V_{cyl}	400 cm ³	400 cm ³	500 cm ³
Compression Ratio	10.5	14 to 17	15.7
Valves	4	2	4
Tumble ratio	2.4		
Swirl ratio		2	1.1

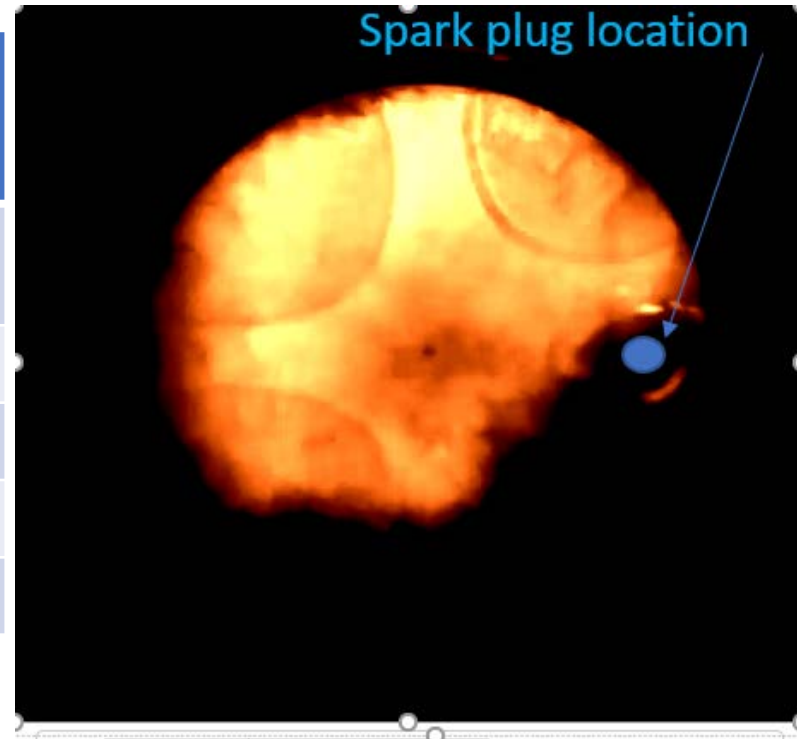

FULLY PREMIXED PROPAGATION

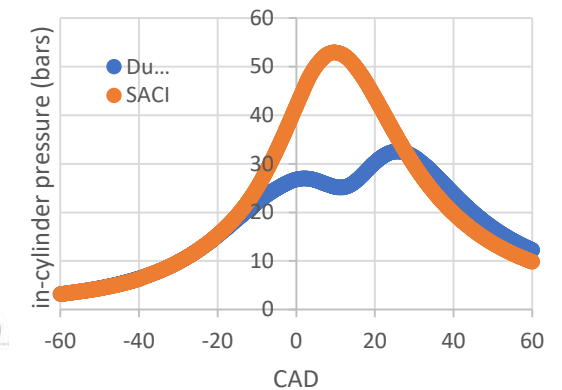

ER NH₃ = 0.9

IMEP = 6.7 b

- Engine speed : 1000 rpm,
- Intake pressure = 0.9 bar
- Tintake = 35°C, Spark timing : -40 CAD

3 images/CAD, during 67 CAD

PREMIXED TURBULENT FLAMES

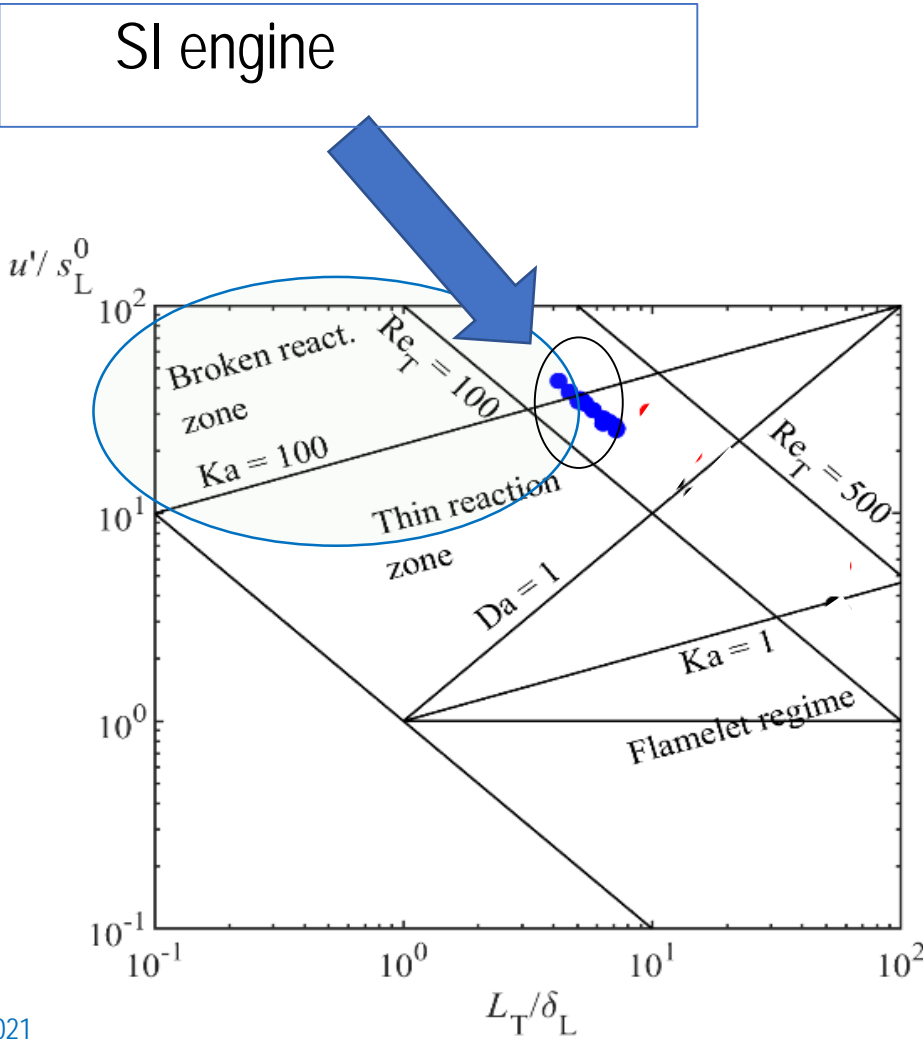

u'/s_L^0
 10^2
 10^1
 10^0
 10^{-1}

Broken react. zone
 $Re_T = 100$
 $Ka = 100$
 Thin reaction zone
 $Da = 1$
 $Re_T = 500$
 $Ka = 1$
 Flamelet regime

L_T/δ_L
 10^{-1} 10^0 10^1 10^2

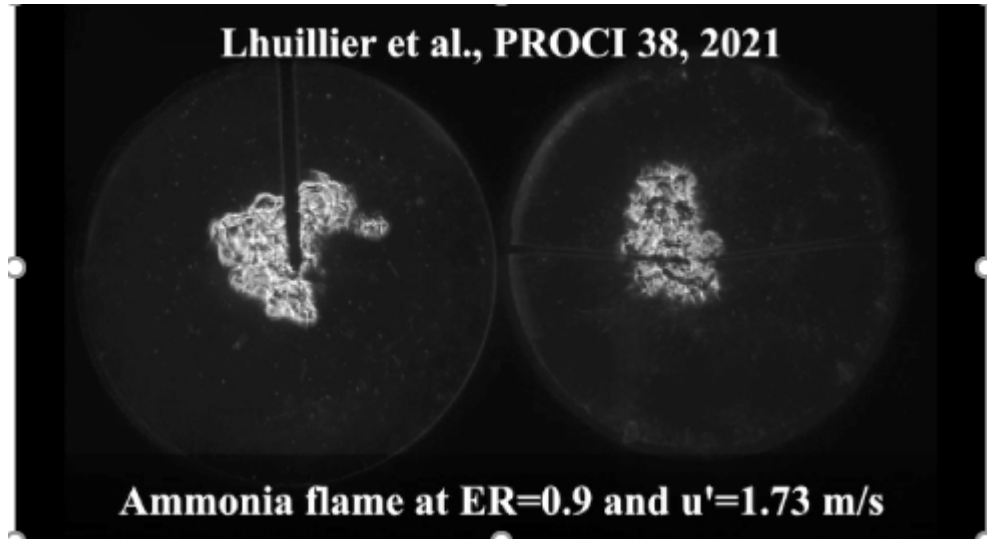

- SACI combustion mode :
 - CR increase
 - P and T increase
 - Turbulent scale size ? Flamelet regime ?

Lhuillier et al. PROCI 2021
 $L_T = 4$ mm

PREMIXED TURBULENT FLAMES

SI to « SACI » :

	SI	SACI
P (SIT)	8 b	12 b
T (SIT)	640K	698 K

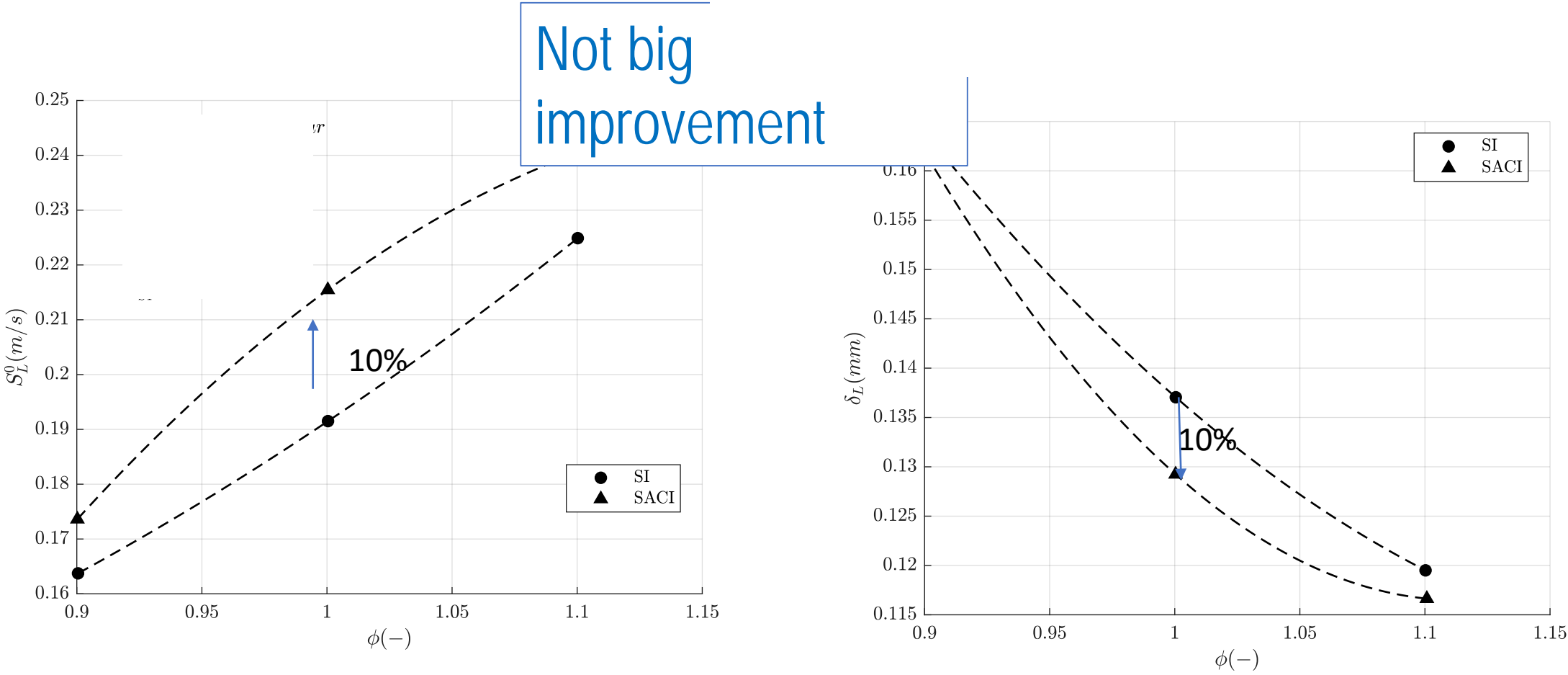

Correlation from Lhuillier, C., Brequigny, P., Lamoureux, N., Contino, F., Mounaim-Rousselle, C., Fuel 263, p.116653, 2020

PREMIXED TURBULENT FLAMES

SI to SACI :

	SI	SACI
P (SIT)	8 b	12 b
T (SIT)	640K	698 k

Less than H₂ !!

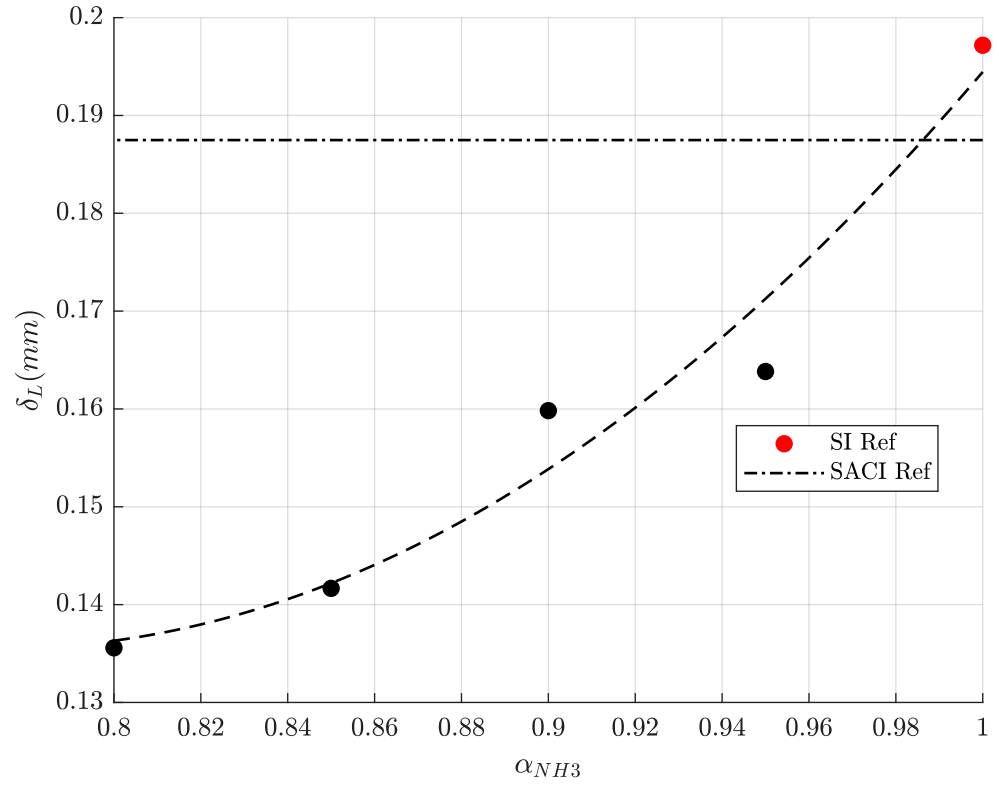
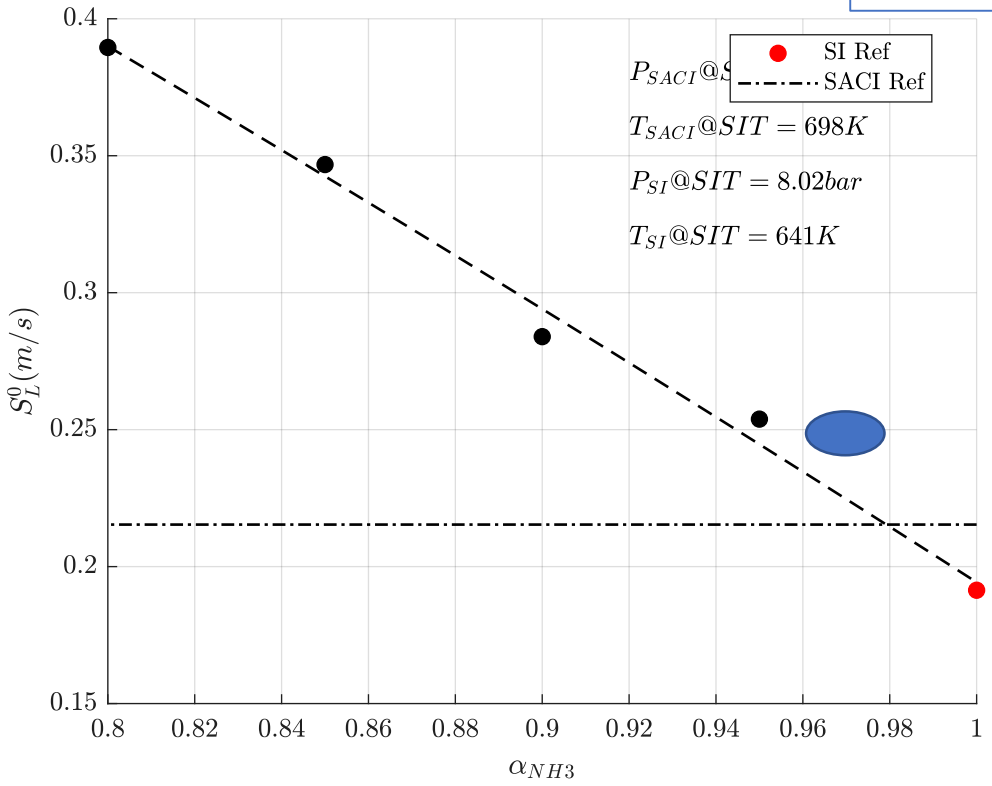

PREMIXED TURBULENT FLAMES

	SI	SACI
P (SIT)	8 b	12 b
T (SIT)	640K	698 K
$U'(SIT)^*$	2.5 m/s	1.5 m/s
L_T (mm)*	1.5 mm	0.8 mm

Converge CFD

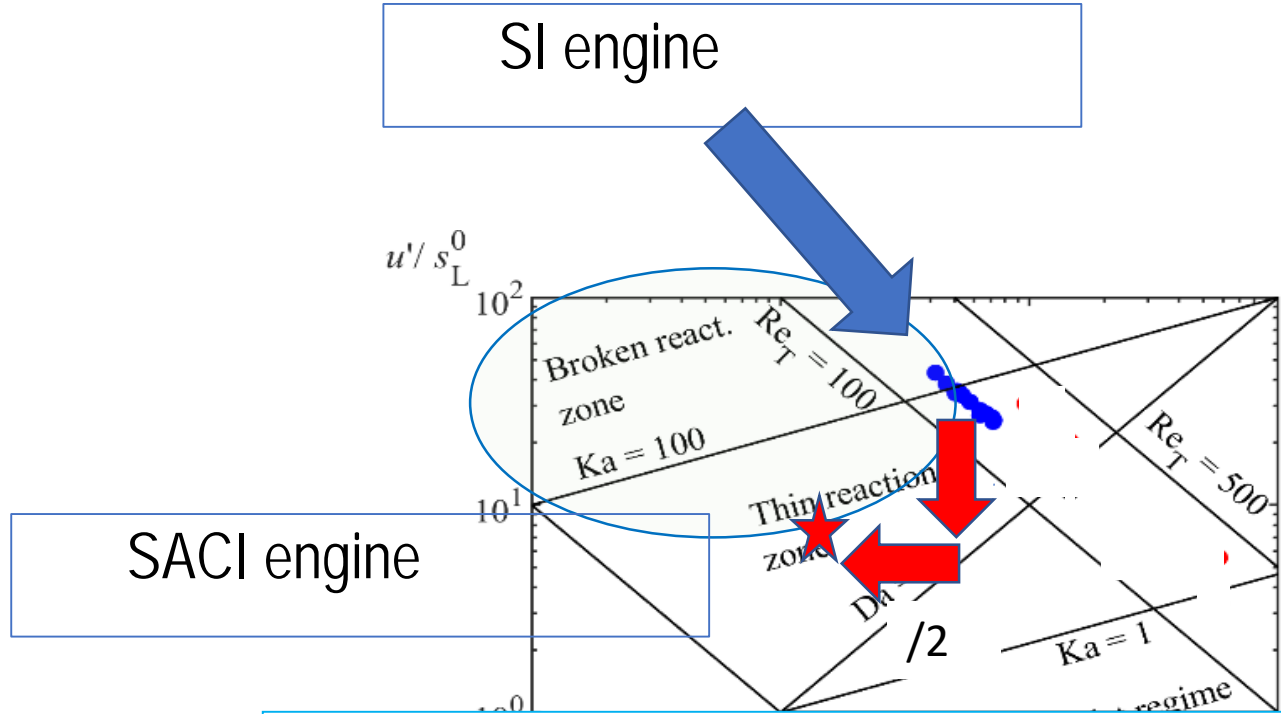

- What flow field ?
- What engine design for AMMONIA Combustion ?

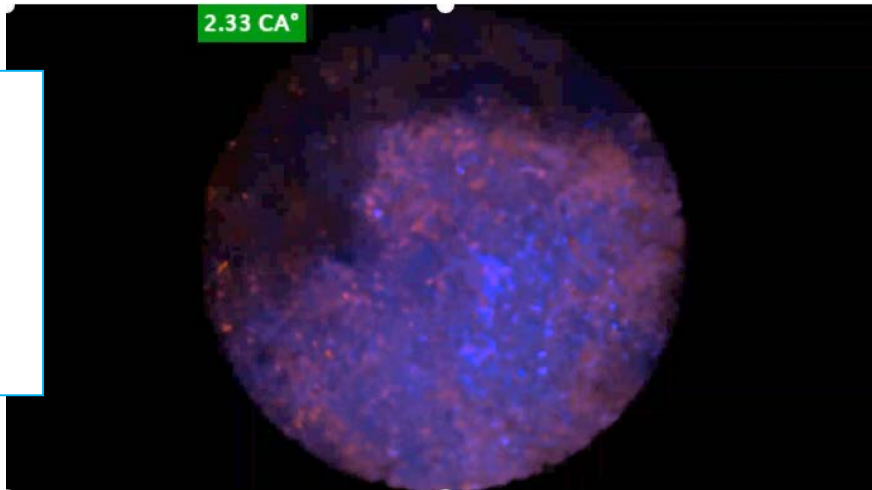

Lhuillier et al.
 $L_T = 4$ mm

POLLUTANT EMISSIONS : UNBURNT

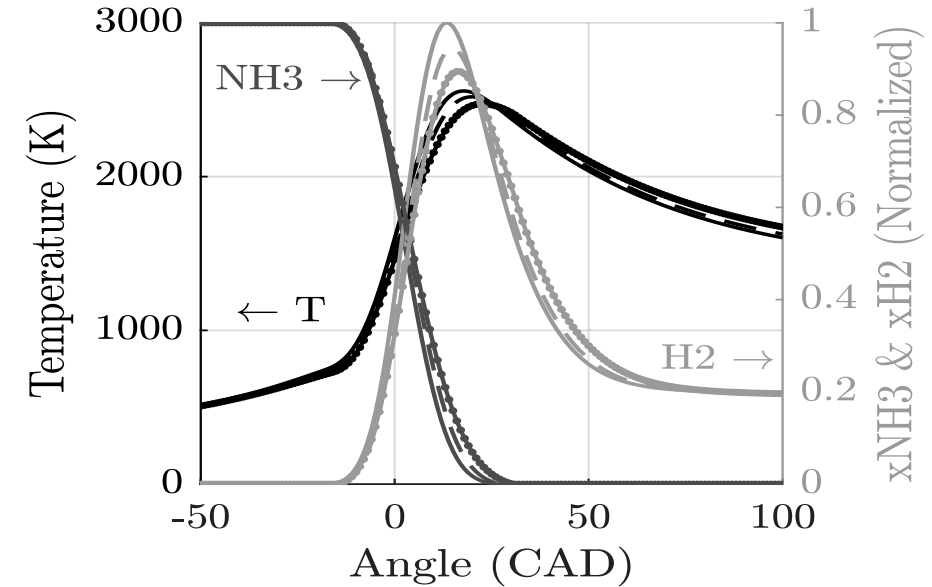
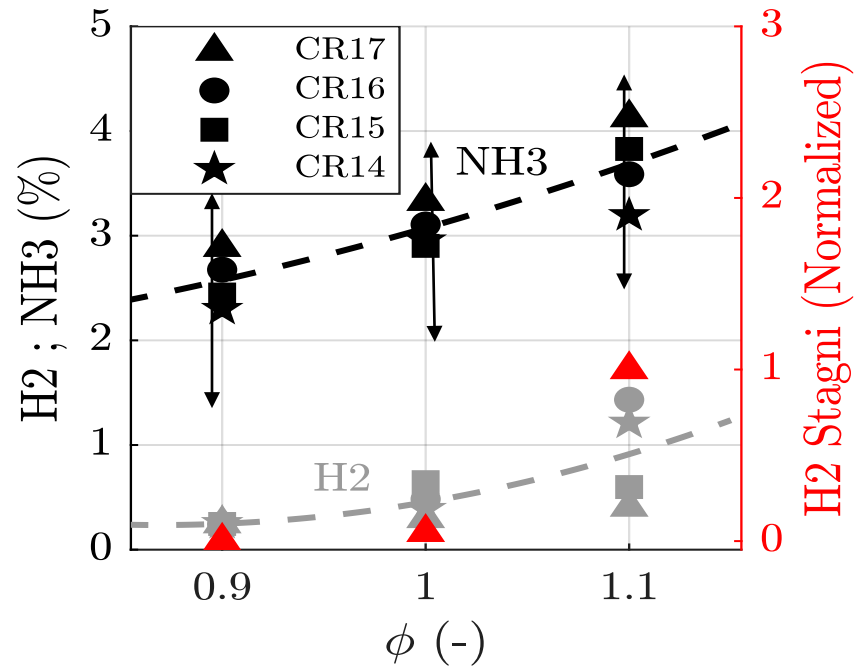

Stagni et al. 2020, reaction chemistry and engineering

DOI: [10.1039/c9re00429g](https://doi.org/10.1039/c9re00429g)

OD SI engine modelling CHEMKIN ANSYS

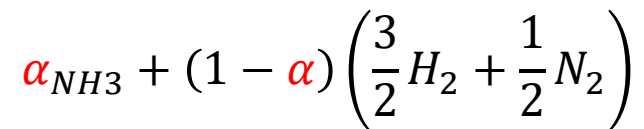

- SACI combustion mode :
 - HT/HP = in situ NH₃ decomposition in H₂

Actual work : NH₃-fueled single-cylinder SI engine

Different engines designs :

Spark Ignition engine (SI)

Spark Assisted Compression Ignition (SACI)

Large Stroke Spark-Ignition engine (SILC)= research engine

	SACI (DV6)	SI (EP6) [ref]	SI LC
Displaced volume	390 cm ³	400 cm ³	535 cm ³
Stroke	88.3 mm	85.8 mm	115 mm
Bore	75 mm	77 mm	77 mm
Connecting rod length	136.8 mm	138.5 mm	177 mm
Compression ratio	From 14 to 17	10.5	11.75 to 15 (?)
Number of valves	2	4	4
Swirl ratio (50 CAD BDTC)	2.36	0	0
Tumble ratio (50 CAD BTDC)	0	2	Not 0 !



Extension of operating conditions with NH₃ only

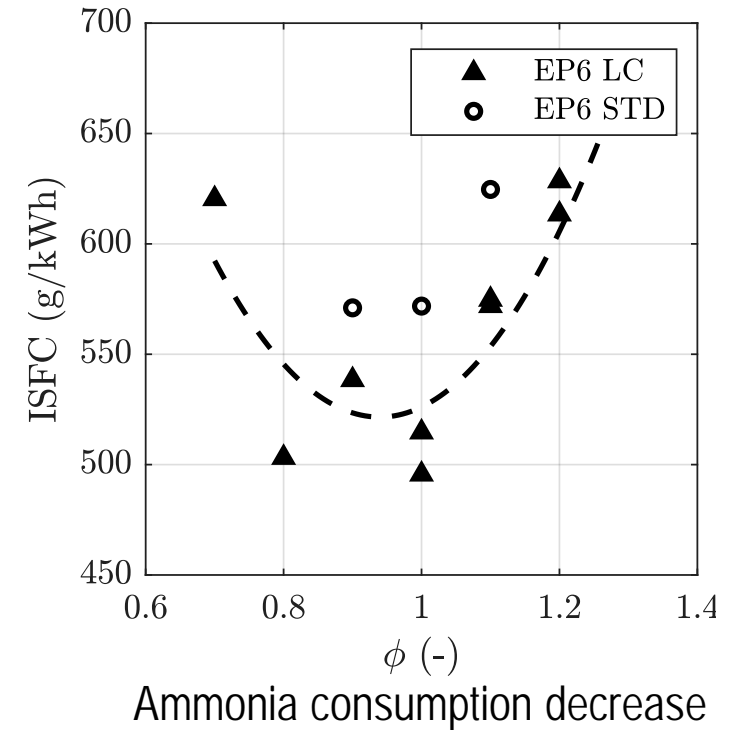
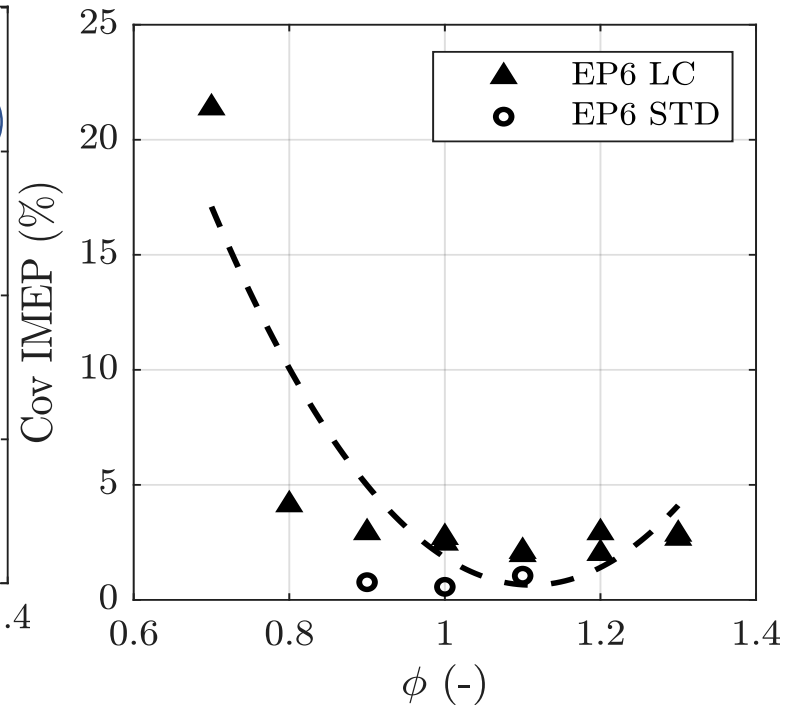
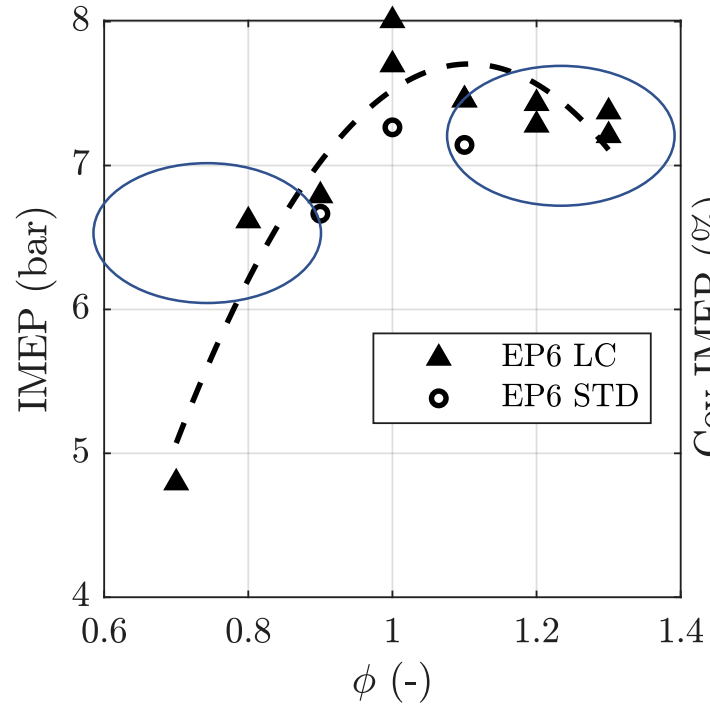

1000 rpm, 80°C *, Pin = 1 atm
* 50 °C pour EP6

Exhaust Emissions

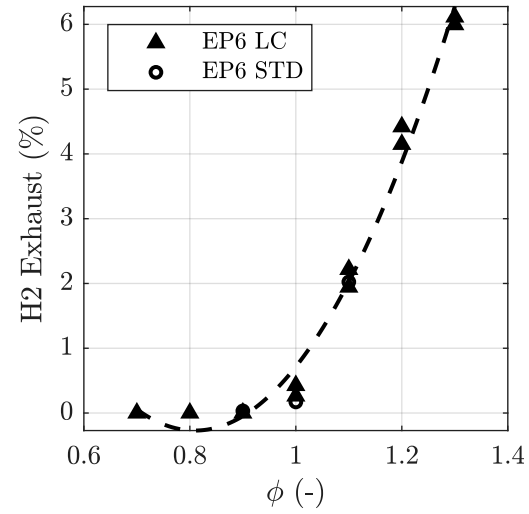
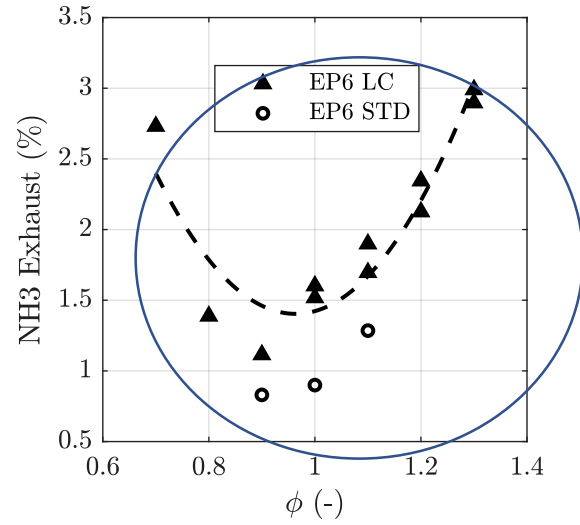

- Higher crevice trap ?
- Lower combustion efficiency ?

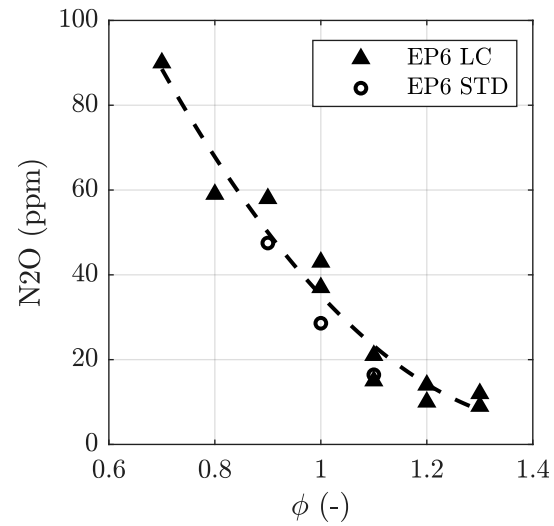
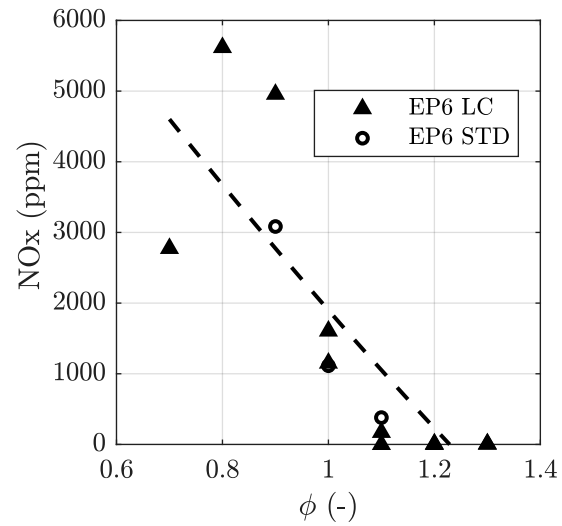

- Similar NOx

POLLUTANT EMISSIONS : TENDENCIES

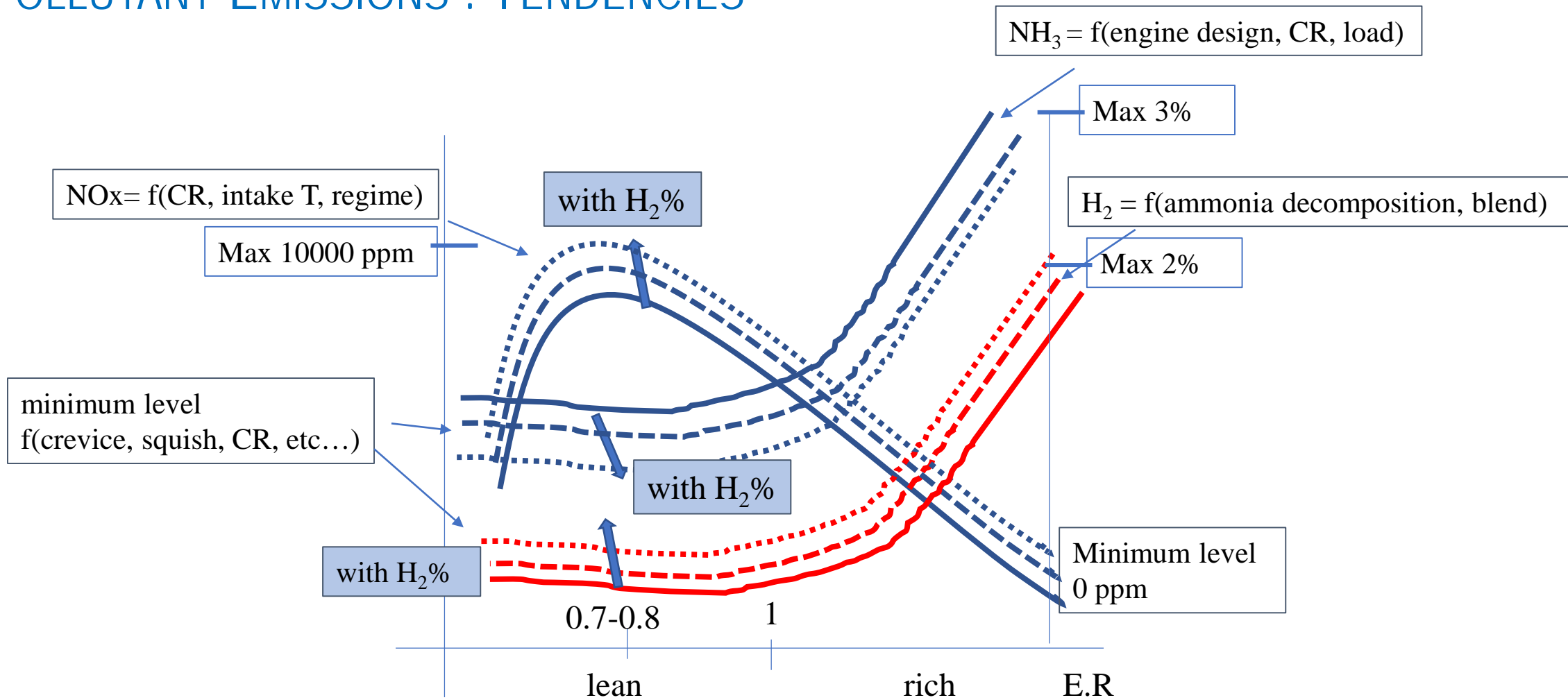

JUST FROM LAST WEEK

NH₃ direct injection

Pin = 120 b
Bosch GDI
No injection pump

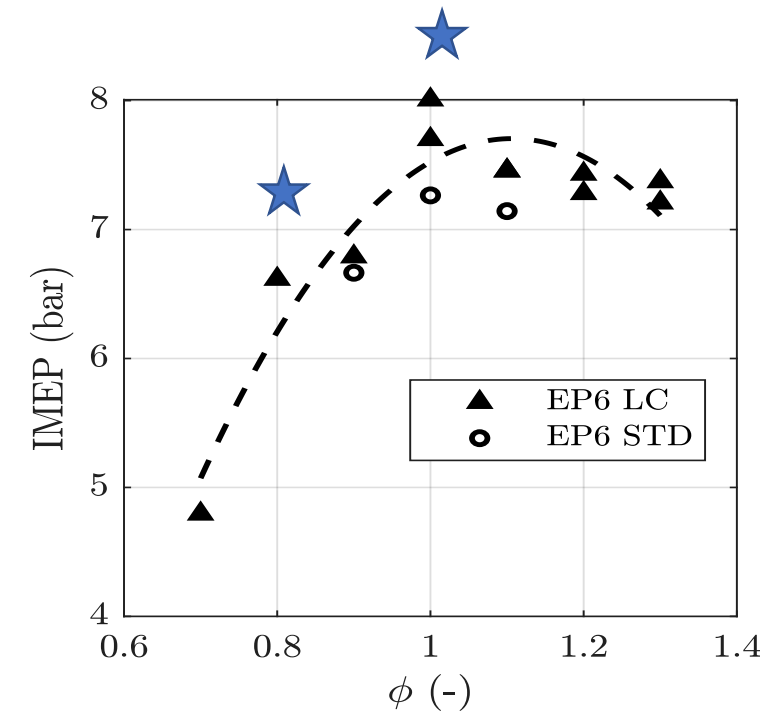
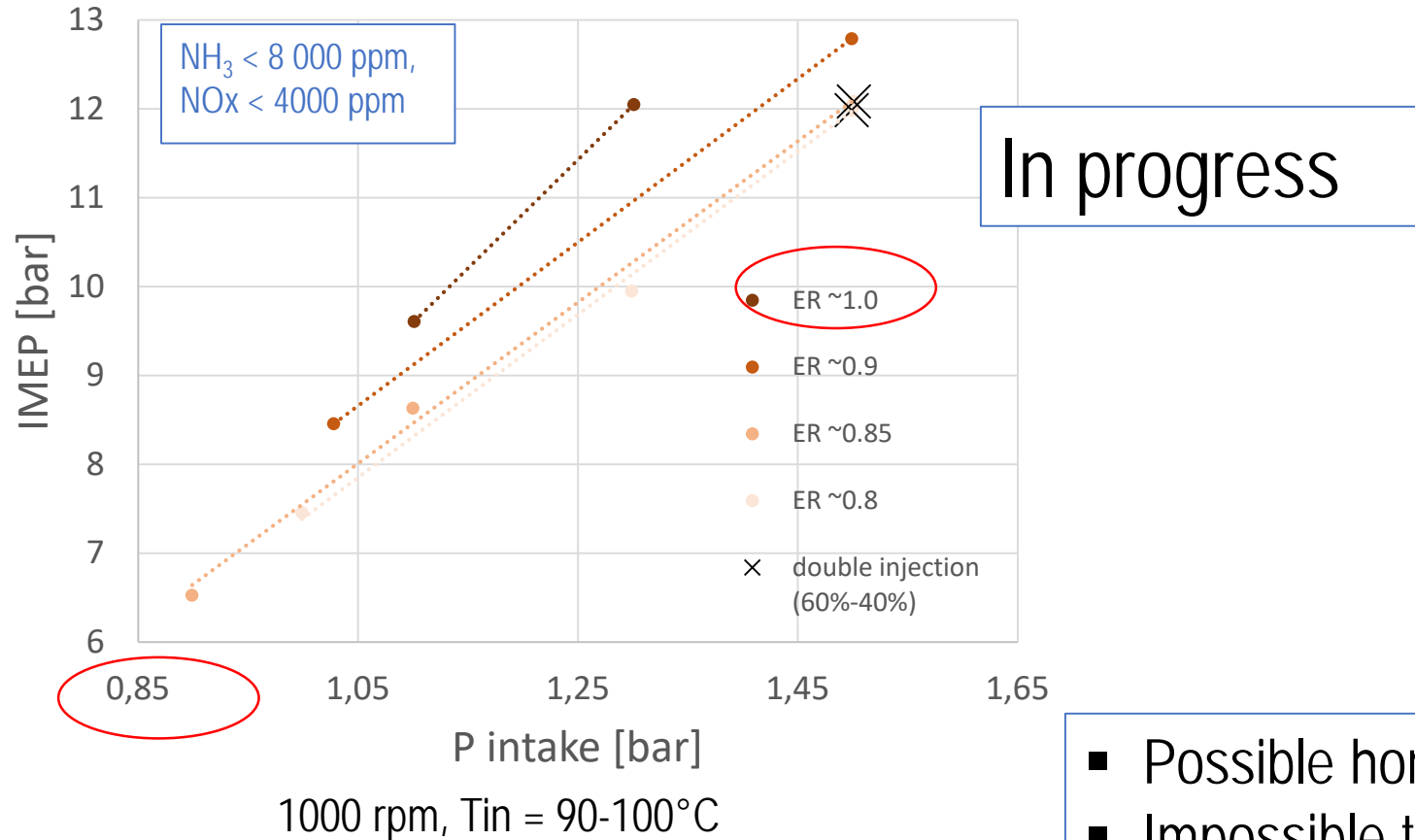
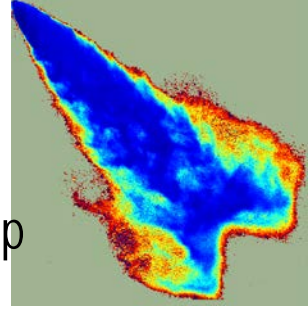

- Possible homogeneous : start of injection 200 BTDC
- Impossible to ignite with late injection
- Split injection : 200 BDTDC / 80BTDC
- impossible 50/50 in mass

CONCLUSION : AMMONIA ONLY IN ICE

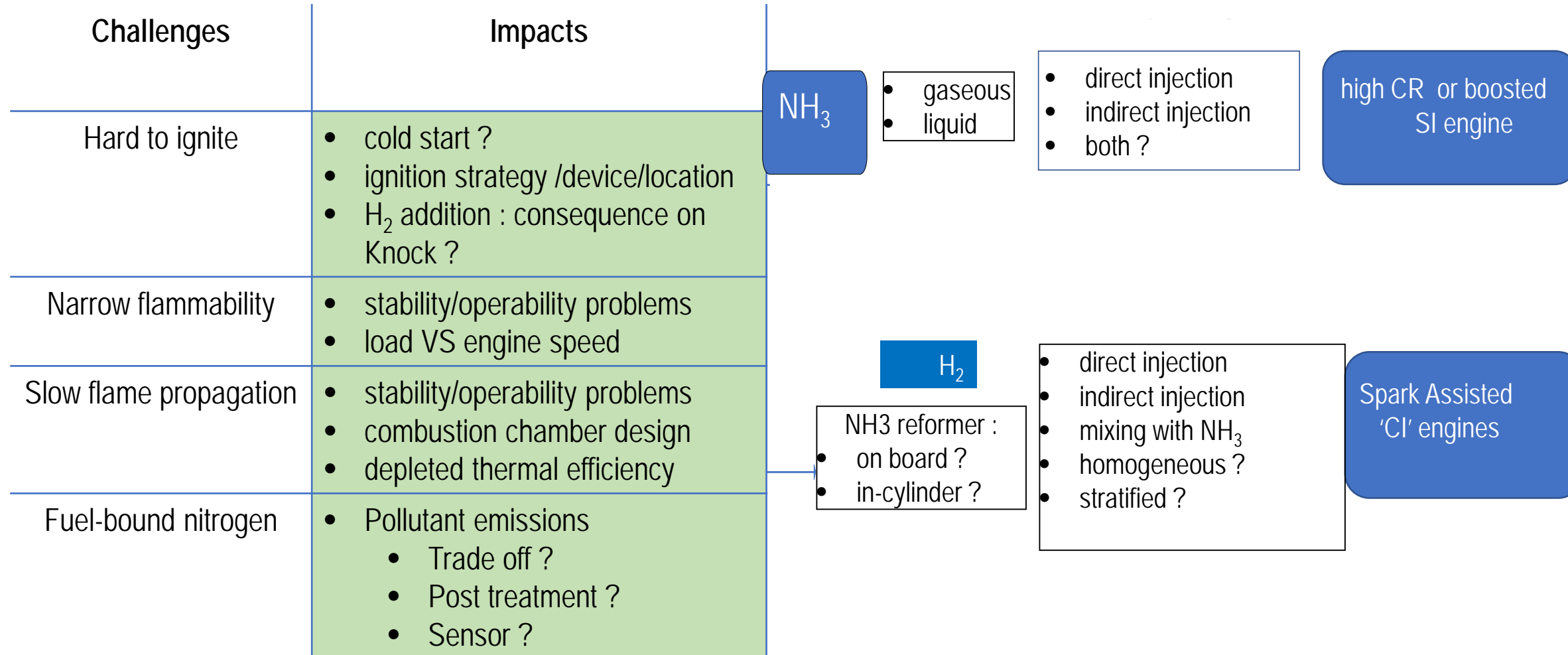

CONCLUSION : AMMONIA ONLY IN ICE

***" There's a
better way to
do it... Find it "***
Thomas Edison

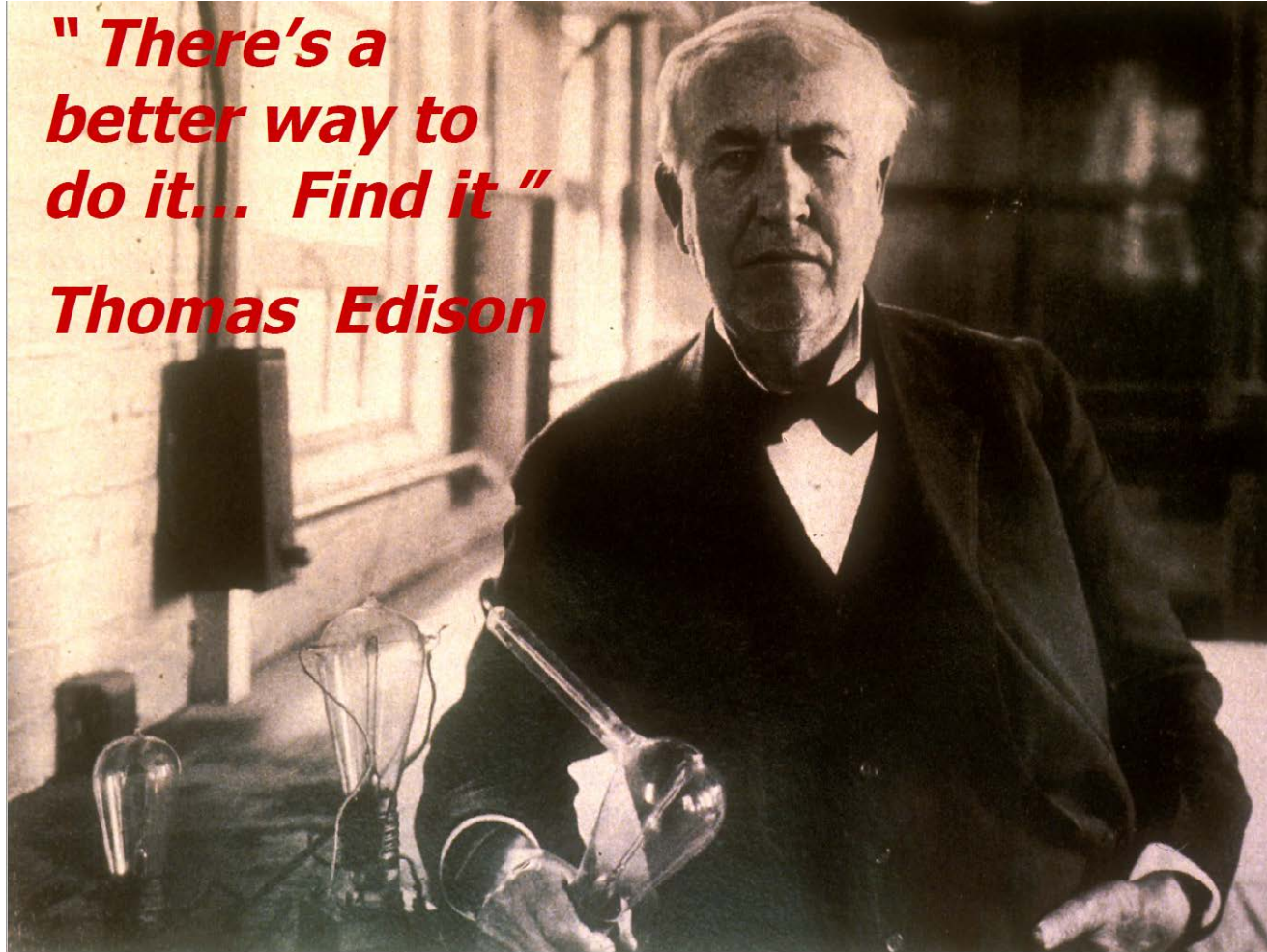

Good luck
and
HAVE FUN



REFERENCES

- Lhuillier, C., Bréquigny, P., Contino, F., Rousselle, C., "Combustion Characteristics of Ammonia in a Modern Spark-Ignition Engine," SAE Technical Paper 2019-24-0237, 2019,
- Lhuillier, C., Bréquigny, P., Contino, F., Rousselle, C., "Performance and Emissions of an Ammonia-Fueled SI Engine with Hydrogen Enrichment," SAE Technical Paper 2019-24-0137, 2019
- Mounaïm-Rousselle C., Brequigny P. (2020) Ammonia as Fuel for Low-Carbon Spark-Ignition Engines of Tomorrow's Passenger Cars. *Front. Mech. Eng.* 6:70.
- Lhuillier, C., Brequigny, P., Contino, F., Mounaïm-Rousselle, C., Experimental study on ammonia/hydrogen/air combustion in spark ignition engine conditions, *Fuel* 269,117448, 2020
- Lhuillier, C., Brequigny, P., Lamoureux, N., Contino, F., Mounaïm-Rousselle, C., Experimental investigation on laminar burning velocities of ammonia/hydrogen/air mixtures at elevated temperatures, *Fuel* 263, p.116653, 2020
- Shrestha K. P., Lhuillier C., Barbosa, A., Brequigny P., Contino F., Mounaïm-Rousselle C., Seidel L., Mauss F., An experimental and modeling study of ammonia with enriched oxygen content and ammonia/hydrogen laminar flame speed at elevated pressure and temperature, *Symp. (Int.) Combust*, 2020,PROCI
- Lhuillier C., Brequigny P., Contino F., Mounaïm-Rousselle C., An experimental and modeling study of ammonia with enriched oxygen content and ammonia/hydrogen laminar flame speed at elevated pressure and temperature, *Symp. (Int.) Combust*, 2020, *Proceedings of the Combustion Institute*, Volume 38, Issue 4, 2021, Pages 5859-5868, <https://doi.org/10.1016/j.proci.2020.08.058>.
- Mounaïm-Rousselle C, Brequigny P, Houillé S, et al. (2020) Potential of Ammonia as future Zero-Carbon fuel for future mobility: Working operating limits for Spark-Ignition engines. In: *SIA POWERTRAIN & ENERGY 2020*, <https://hal.archives-ouvertes.fr/hal-03188481>
- **Mounaïm-Rousselle C**, Mercier A, Brequigny P, Dumand C, Bouriot J, Houillé S. Performance of ammonia fuel in a spark assisted compression Ignition engine. *International Journal of Engine Research*. August 2021. doi:[10.1177/14680874211038726](https://doi.org/10.1177/14680874211038726)
- K.H.R. Rouwenhorst, O. Elishav, B. Mosevitzky Lis, G.S. Grader, C. Mounaïm-Rousselle, A. Roldan, A. Valera-Medina, *Techno-Economic Challenges of Green Ammonia as an Energy Vector*, Book chapter : Chapter 13 - Future Trends, Editor(s): Agustín Valera-Medina, René Banares-Alcantara,, Academic Press, 2021, Pages 303-319
- A. Valera-Medina, F. Amer-Hatem, A. K. Azad, I. C. Dedoussi, M. de Joannon, R. X. Fernandes, P. Glarborg, H. Hashemi, X. He, S. Mashruk, J. McGowan, C. Mounaim-Rousselle, A. Ortiz-Prado, A. Ortiz-Valera, I. Rossetti, B. Shu, M. Yehia, H. Xiao, and M. Costa, A review on ammonia as a potential fuel: from synthesis to economics,, *Energy & Fuels*, DOI: 10.1021/acs.energyfuels.0c03685
- Pele R., Hespel C., Brequigny P., Belettre J., Mounaïm-Rousselle C. First study on ammonia spray characteristics with current injector of GDI engines, *Fuels* **2021**, *2(3)*, 253-271; <https://doi.org/10.3390/fuels2030015> -
- Mounaïm-Rousselle C, Mercier A, Brequigny P, Dumand C, Bouriot J, Houillé S. Performance of ammonia fuel in a spark assisted compression Ignition engine. *International Journal of Engine Research*. August 2021. doi:[10.1177/14680874211038726](https://doi.org/10.1177/14680874211038726)
-

ARENHA

Advanced materials and Reactors for EEnergy storage tHrough Ammonia

