



HAL
open science

Spray combustion characteristic of ABE/gasoline surrogate blend for partially premixed combustion mode

Tung Lam Nguyen, Camille Hespel, Christine Mounaïm-Rousselle

► To cite this version:

Tung Lam Nguyen, Camille Hespel, Christine Mounaïm-Rousselle. Spray combustion characteristic of ABE/gasoline surrogate blend for partially premixed combustion mode. ILASS-Europe 2019, 29th Conference on Liquid Atomization and Spray System, Sep 2019, Paris, France. hal-03516587

HAL Id: hal-03516587

<https://hal.science/hal-03516587v1>

Submitted on 7 Jan 2022

HAL is a multi-disciplinary open access archive for the deposit and dissemination of scientific research documents, whether they are published or not. The documents may come from teaching and research institutions in France or abroad, or from public or private research centers.

L'archive ouverte pluridisciplinaire **HAL**, est destinée au dépôt et à la diffusion de documents scientifiques de niveau recherche, publiés ou non, émanant des établissements d'enseignement et de recherche français ou étrangers, des laboratoires publics ou privés.

Spray combustion characteristic of ABE/gasoline surrogate blend for partially premixed combustion mode

Tung Lam Nguyen^{*a,b}, Camille Hespel^a, . D.H. Long^c, Christine Mounaïm-Rousselle^{aa}

^a Univ. Orléans, INSA CVL, PRISME, EA 4229F45072 Orléans, France

^b Univ. Transport and Communications, No 3 Cau Giay St., Dong Da District, Hanoi 112345, Vietnam

^c Hanoi University of Science & Technology, Hanoi, Vietnam

Corresponding Author: tung-lam.nguyen@etu.univ-orleans.fr ; lamnt@utc.edu.vn

Abstract

Bio-alcohols, especially methanol, ethanol, butanol have received a lot of attention as potential future alternative fuels to pure gasoline. Even if bio-butanol has several advantages compared to ethanol and methanol, the main issue preventing n-butanol's use in modern engines is its relatively high production and energy costs. But Acetone-Butanol-Ethanol (ABE), the intermediate product from the fermentation process for bio-butanol production, is more and more considering as another alternative fuel. In this paper, the experimental study of spray and combustion processes of ABE blends with gasoline surrogate (Primary Reference Fuel 80) was performed under high-pressure and high-temperature controlled conditions in a reactive atmosphere, similar to compression ignition conditions before start of combustion, as defined in Engine Combustion Network. These first experimental results indicate that both ignition delay and lift off length increase with the increase of ABE ratio in PRF80 blends. As longer is the ignition delay of ABE blends as leaner is the mixture at the ignition time, inducing stronger premixed combustion phase and therefore shorter combustion duration.

Keywords: ABE, biofuels, spray, combustion, lift off length, ignition timing

Introduction

As butanol contains 30% more energy than ethanol, to use n-butanol as a transportation fuel can save 39-56% fossil energy while reducing greenhouse gas emissions by up to 48% on a life cycle analysis[1]. Moreover, butanol can be easily mixed with gasoline or diesel in higher proportion than methanol or ethanol. Several studies evaluated butanol as an alternative fuel for Compression Ignition (CI) Engine [2-6]. Especially, Bei et al. [6] investigated the impact of n-butanol in diesel blends in the case of Partial Premixed Combustion mode. The results showed that the heat release was delayed and the total number and mass concentration of the particulates both reduced obviously, when the n-butanol ratio was increased. However, one main issue that prevents butanol's use in modern engines is its relatively high cost of its production. If the Acetone-Butanol-Ethanol (ABE) mixture, one intermediate product, could be promoted as a clean biofuel, the cost will be more attractive. Only a few studies have been focused on ABE as an alternative fuel for Internal Combustion engines [7-10] but even less on fundamental aspects as spray or combustion processes [11-14]. As example, Chang et al. [8] investigated ABE-diesel blends on diesel engine and concluded that 20% in volume of ABE could enhance the brake thermal efficiency until 8.56% and reduced PM, NO_x and PAHs emissions until 61.6%, 16.4% and 31.1%, compared to those from diesel fuel. Li et al. [10] evaluated the effect of ABE-gasoline blends on the combustion characteristics and emissions in a port-fuel injection SI engine and concluded that ABE can both improve output power and pollutant emissions.

To evaluate ABE as a substitute fuel candidate, Wu et al. [11] and Zhou et al [12] investigated ABE-diesel blends on spray combustion characteristics under conventional Compression Ignition (CI) and Low Temperature Combustion (LTC) conditions. The results showed that under those conditions, the increase of ABE amount in diesel blends increases the ignition delay and lift off length in comparison to pure diesel. Wu et al. [13] also evaluated the effect of acetone and butanol amounts in ABE (20% vol.) blend on conventional CI Combustion. Nilaphai et al. [14, 15] investigated the effect of ABE amount in n-dodecane (a diesel surrogate) blends from 20% to 50% in volume, on the spray and combustion characteristics, in comparison with ethanol and/or butanol diesel blends. The results confirm that ABE20 can be used in CI conditions as classical diesel fuel due to its shorter ignition delay and lift off length in comparison to ethanol and butanol blends. In their recent review, Li et al. [16] concluded that although some studies have been conducted, in order to convince first about the possibility by using ABE in Internal Combustion Engines, new comprehensive studies have to be done especially to suggest the best combustion technologies. Moreover, the potential of ABE blended in gasoline fuel never was investigated in the case of Gasoline Partially Premixed Combustion, when gasoline is used in CI engine.

Therefore, the main motivation of this study is to provide new unique data on Ignition delay and lift-of left at High Temperature-High Pressure conditions as in CI engine, based on operating conditions suggested by Engine Combustion Network [17].

2. Experimental approach

2.1 Experimental facility

The High Pressure-High Temperature vessel called NOSE is based on single cylinder engine, driven by an electric motor (Figure 1), just used during one compression-expansion stroke to generate stable conditions during 15 ms. The vessel was designed to study spray process by the use of optical techniques (so 4 quartz windows of 25X25X80 mm³). The operating mode of NOSE was fully described in [18]. After the vacuum, the gases (N₂ and/or O₂) are injected into the chamber using Brooks mass flow controllers. The controlled temperature of the cylinder head, thanks to heated water and 4 other heaters, was set to 90°C (± 0.5°C) and the injector temperature is assumed at the same temperature.

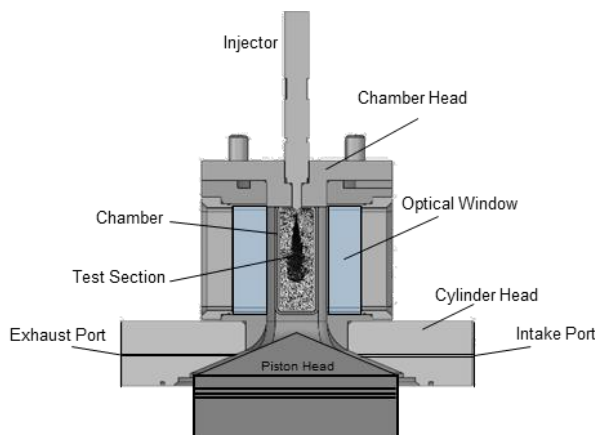

Figure 1. The cross-section view of NOSE chamber.

The temporal signal of in-cylinder pressure recorded at 40 kHz (from high response piezo-electric pressure sensor (KISTLER 7001), temperature (from thermocouples) inside the vessel, driven current of the injector, photomultiplier signal and crank angle degrees are recorded by a National Instrument CompactRIO at 250 kHz. A PID closed loop adjusts both the pressure and the temperature inside the vessel.

2.2 The injection system

The injection system consists of components: a high-pressure pneumatic pump (MAXIMATOR M189 DVE-HD) and a high-pressure line. The injection pressure is regulated before the injection, thanks to a PID system. As Spray A condition represents classical operating conditions in CI engine (Table 1) was chosen as reference standard conditions, a single-hole BOSCH CRI injector (88.50 μm diameter and 1.5 k-factor) was chosen. The nozzle tip of the fuel injector was held at a constant temperature of 363 K by the circulation of a coolant during operation. Two differences between the operating conditions of this study and the standard Spray A ones are the fuel itself, based on gasoline surrogate and the injection pressure, set at 400 bar, related to previous studies of Gasoline Compression Ignition combustion mode [19].

2.3 Test fuels

In this study, the gasoline surrogate is a mixture of 80% iso-octane and 20% of n-heptane, usually named PRF80. The ABE solution was prepared with 30% of analytical grade acetone (99.5%), 60% n-butanol (99.5%) and 10% ethanol (99.8%) in volume as ABE 3-6-1 is the most commonly produced during the fermentation process. The properties of these pure components are given in Table 2. The surrogate was blended with ABE in increment of 20 % volume ratio of ABE (ABE20, ABE40, ABE60), pure PRF80 will be referred to ABE0. As the latent heat of vaporization of acetone, n-butanol and ethanol, so of ABE mixture is higher than PRF80, it would cause a drastic cooling effect. The lower boiling point of acetone (56°C) could also help the blend's spray collapse significant. From Table 3, it can be noted that the increase of the ABE amount in the fuel decreases the heating value. The energy content of ABE on the total energy content of the blend, called ABEeR, is also indicated. Last, the higher Research Octane Number (RON) of ABE would indicate that the Ignition delay would be increased as a function of the ABE amount.

Table 2. Fuel properties of pure fuels

Properties	n-heptane	iso-octane	PRF80	n-butanol	acetone	ethanol	Unit
Molecular formula	C ₇ H ₁₆	C ₈ H ₁₈	C _{7.8} H _{17.6}	C ₄ H ₉ OH	C ₃ H ₆ OH	C ₂ H ₅ OH	
Density at 15 °C	0.684	0.692	0.6904	0.8098	0.791	0.795	kg/m ³
Kinematic Viscosity at 15 °C	0.39	0.50	0.478	2.544	0.35	1.08	mm ² /s
Lower heating value	44.6	44.3	44.36	33.1	29.6	26.8	MJ/kg
RON	0	100	80	96	117	108	
Boiling point	98.38	99.3	-	117.8	56.2	78.5	°C
Vapor pressure at 298 K	4.6	5.5	-	0.9			kPa
Self-ignition temperature	220	396	-	343	518	392	°C
Latent heat of vaporization at 298 K	316	272	280.8	716	518	904	kJ/kg
Oxygen content			-	21.6	27.6	34.8	wt. %
Stoichiometric ratio	15.14	15.09	15.10	11.21	9.54	9.02	-

Table 3. Properties of ABE blends

	ABE0(=PRF80)	ABE20	ABE40	ABE60
Ron (from linear volume weighted model)	80	84.7	89.4	94.1
Lower heating value (MJ/kg)	44.33	42.70	40.69	38.31
ABE_r (%)	0	47.2	54.4	64.1

2.4 Optical techniques

As the main objective is to estimate ignition delays and lift-off length, different optical diagnostics were set as schematized in Figure 2 with some details given in Table 3 and more details in [18]. In summary, the Schlieren technique was implemented to detect the vapour phase and the ignition. The OH* chemiluminescence imaging allows the determination of Flame Lift-Off Length (LOL), defined as the distance between the injector tip and the stabilization of the flame. A long constant gating time of 449 μs was used to avoid effect of turbulent fluctuation in the LOL determination in order to provide an image of the ‘quasi-steady’ mean LOL after the Start of Ignition. The start of combustion will be also determined from the recording of the OH* chemiluminescence, corrected by the hydraulic delay itself to provide absolute ignition delay as it will be explained below.

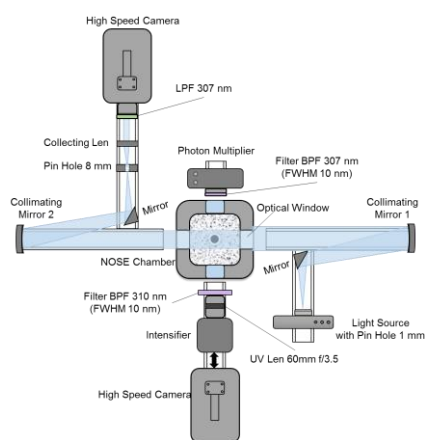

Figure 2. Scheme of optical arrangements around NOSE set-up

Table 4. Some details of optical setup to estimate combustion characteristic parameters

Optical Technique	Schlieren	OH* Chemiluminescence.	OH* Chemiluminescence.
Parameters	Ignition delay	Ignition delay	Lift off length
Light source	LED (white) with 1 mm pinhole	No	No
Optical set-up	2 Parabolic Mirrors + 6 mm pinhole	-	-
Camera/ Detector and filter	Phantom-V1611 CMOS LPF ≤ 550 nm (Asahi VS0550)	Oriel PMT 70680 BPF 307 nm, FWHM 10 nm (Ealing 35-7939)	Photron - APX-I2 – CMOS with UV 60 mm f/3.5 BPF 310 nm, FWHM 10 nm (Asahi ZBPA310)
Frequency rate	39 kHz	250 kHz	2 kHz
Exposure time	5 μs	-	499 μs

Image size and magnification	1024 x 400 pix ² , 12.3 pix/mm	-	512 x 1024 pix ² , 18.2 pix/mm
------------------------------	---	---	---

2.5. Analysis Methodology

The physico-chemical ignition delay, ID, is one of important parameters especially in the case of CI conditions. It is the duration between the Start of fuel Injection (SOI) into the combustion chamber and the Start of Combustion (SOC), in the case of fuel spray combustion. First, the SOI was determined from Schlieren visualisation and defined as the time between the start of injection current and the first image where the liquid spray is distinguishable. The time between current command signal and SOI is usually called “hydraulic delay or emergizing time”. In the present specific condition, i.e. at 400 Bar of injection pressure, it was estimated to 3 ms.

Second, the SOC can be estimated through the use of optical techniques as natural chemiluminescence, OH* chemiluminescence signal [20,21] or Schlieren technique [22]. In Figure 3, the evolution of OH* chemiluminescence temporal signal, its first derivative and the second one are plotted. As the estimate of SOC from the first maximum peak of d²OH* seems to be more robust, in the following part the IDs are based on this estimate.

From the images obtained from Schlieren technique, as examples shown in Figure 4a, it is possible to determine the Averaged Spatially integrated Intensity (ASI) as $ASI = \sum_i \sum_j I_{i,j} / N$, with $I_{i,j}$ the image intensity at pixel position

(i, j) and N the total number of pixels. The temporal evolutions of ASI normalized by the maximum value in the case of inert and reactive atmosphere, plotted in Figure 4b are similar until 800 μs, as it can be more seen with first derivative. A good agreement is obtained for ID estimate from OH* signal and NSI for this example (pure PRF80) presented in Figures 3 and 4b.

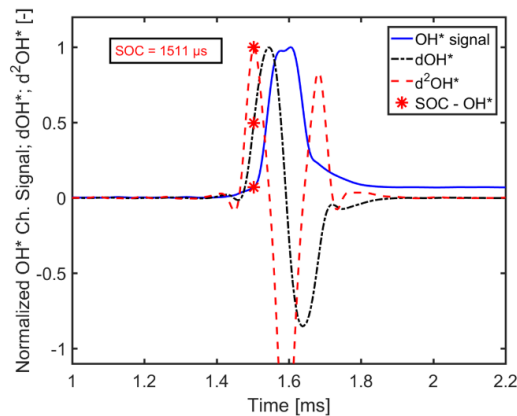

Figure 3. Typical estimate of start of combustion from OH* Chemiluminescence

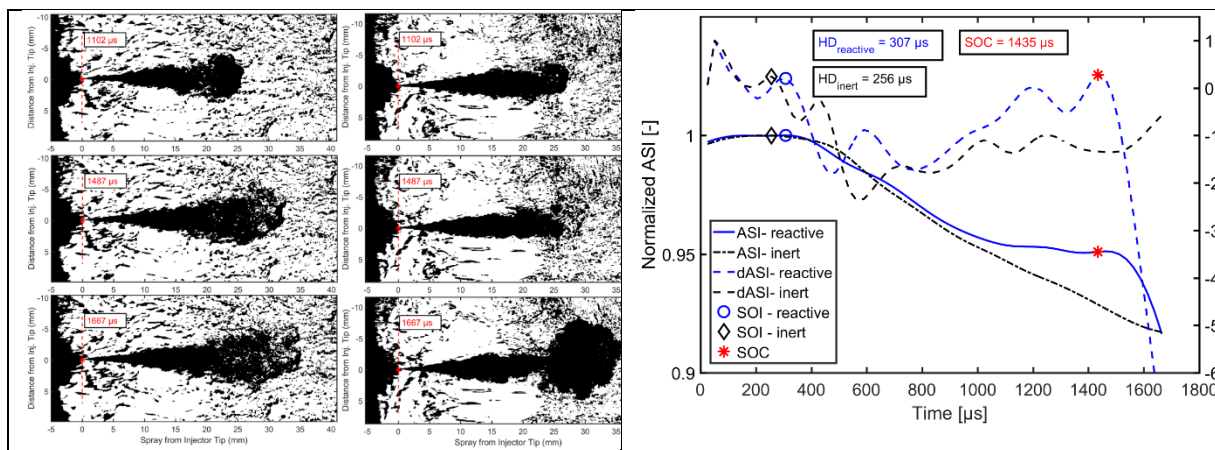

Figure 4a. Schlieren images of inert (left) and reactive (right) condition

Figure 4b. Estimate of start of combustion from Schlieren images

The determination of LOL is also important to characterize and understand the combustion process in case of flame spray combustion. As in Figure 5a, the OH* chemiluminescence images are filtered with a 3x3 pixel mean filter and divided through a medium axis to obtain two profiles (bottom and top ones) as Siebers and Higgins approach [23].

The lift-off length is then estimated by finding below and above the centerline of the combustion zone, the distances between the nozzle tip and the first axial locations, which exhibit an intensity higher than a pre-selected percentage of the local peak as shown in Figure , and then averaging the results of both profiles. The values reported during this study have been calculated with a 50% intensity peak percent, following the same criteria of Benajes et al. in [24].

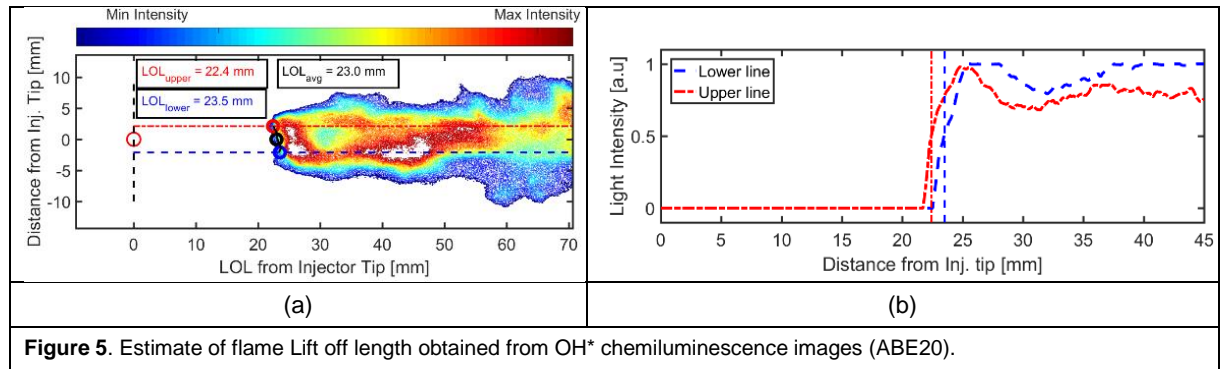

Figure 5. Estimate of flame Lift off length obtained from OH* chemiluminescence images (ABE20).

From the temporal sequence of OH* images as examples presented in Figure 6, a map of the integrated intensity along the radial direction of spray can be done as showed in in Figure 7. The evolution of the corresponding Heat Release Rate (HRR) obtained from the chamber pressure (blue line) is also added. The boundary of the OH* map represents the location where the complete oxidation is reached at the detectability limit of the optical technique.

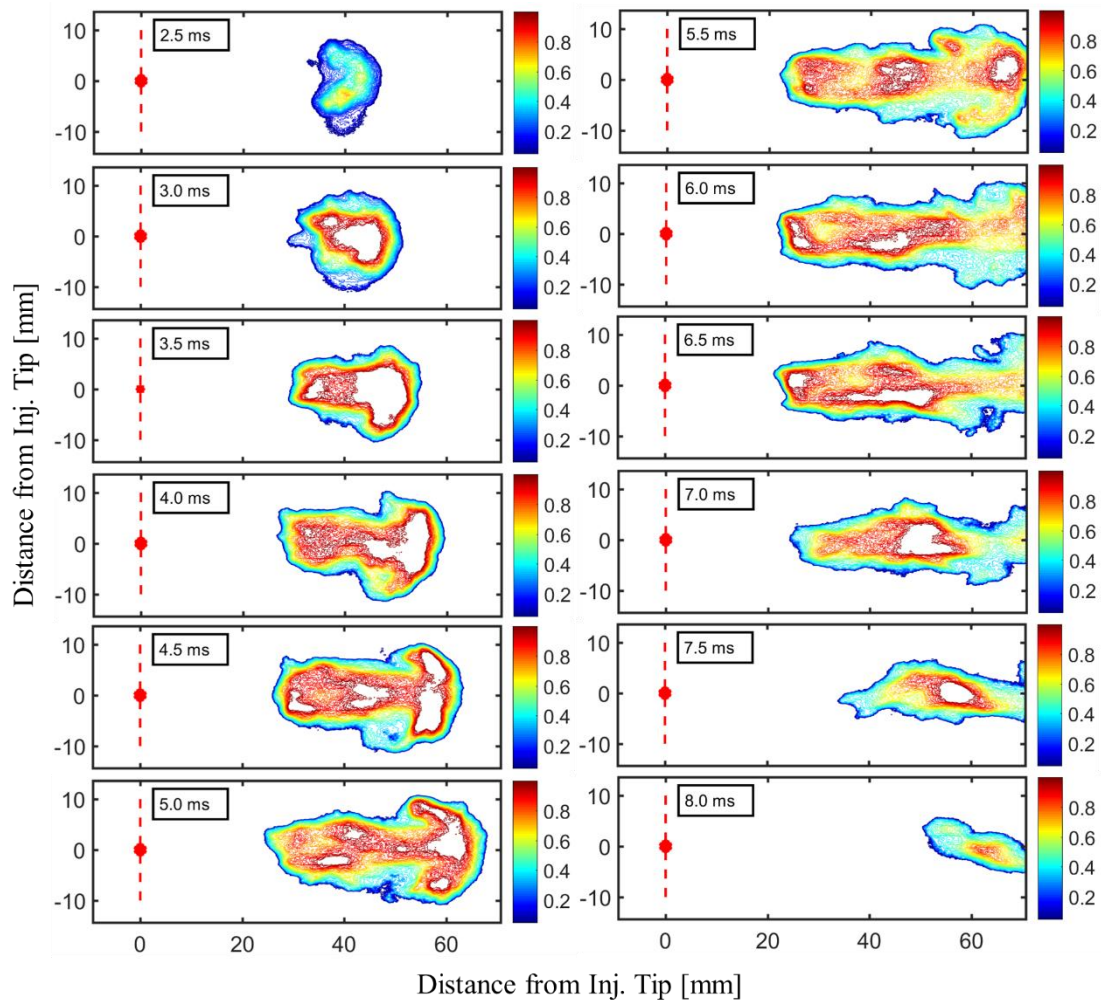

Figure 6. Example of temporal sequence of OH* chemiluminescence images for ABE20

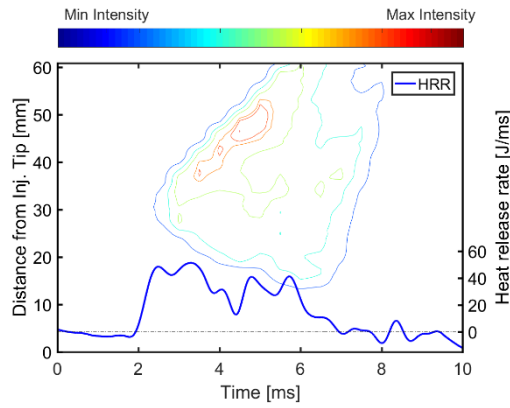

Figure 7. Temporal evolution of OH* chemiluminescence spatial intensity and HRR for ABE20

4. Results and discussion

As expected, due to the higher latent heat of vaporisation, i.e. the cooling effect and the higher RON of ABE in comparison to PRF80, the increase of ABE amounts strongly increases the physico-chemical ignition delays. As the Ignition delay is strongly related to the stoichiometric mixture fraction, it is plotted as a function of the stoichiometric air-fuel ratio and also versus the octane number ratio (estimated with the linear volumetric-weighted model), as presented in Figure 8. Different correlations can be suggested as a function of ABE amount or RON or AFR. As example, a power correlation can be established with a good correlation coefficient (0.98) as $ID_{blend}/ID_{PRF80}=0.957(1-ABEvol)^{1.2}$, related to the present condition (900K, 60b 15%O₂, injection pressure of 400b). This correlation, convenient for the use of fuel in engines has to be universalised as a function of injection pressures and ambient conditions. It can be also seen that the evolution of ID seems to present a change of slope for 60% of amount.

In Figure9, the evolution of in-cylinder pressure and the heat release rate for all tested fuels are plotted. First, due to higher values of the latent heat of vaporization of ABE, the cooling effect can be observed before the start of combustion by the pressure decrease. As expected from the ID estimates with OH* signal, the combustion phasing as a function of the ABE amount increases is more and more delayed. Moreover as indicated in Table 3, the HRR is lower with the increase of ABE content due to the decrease of the initial energy. It can be also noted that the shape of the temporal evolution of HRR is affected by the presence of ABE. Indeed, without ABE, a first strong peak of HRR indicates a rapid premixed combustion phase, followed by a plateau during 4 ms, certainly due to the diffusion phase. As a function of the ABE increase, the combustion duration is strongly decreased. But the first half quantity of the fuel burns faster until this amount is not higher to 50%. Indeed, when 60% of ABE is blended, the shape of HRR evolution is different with a peak after a small plateau so a faster second combustion phase, due to the balance between the cooling effect which affects both the mixing process and the ignition delay and the reactivity of the mixture itself.

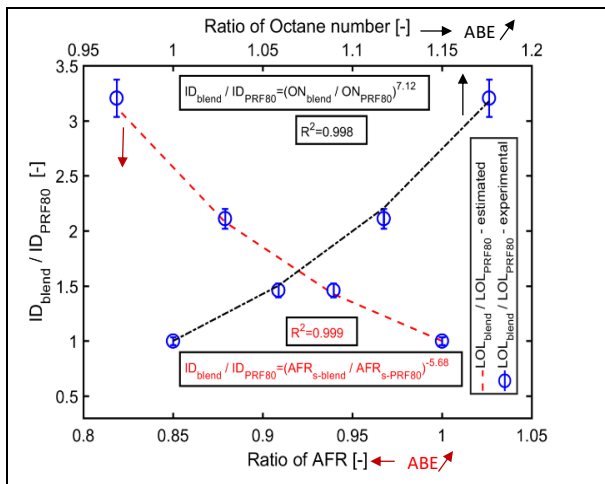

Figure 8. Ignition delay as a function of blend RON and equivalent AFR for ABE amounts.

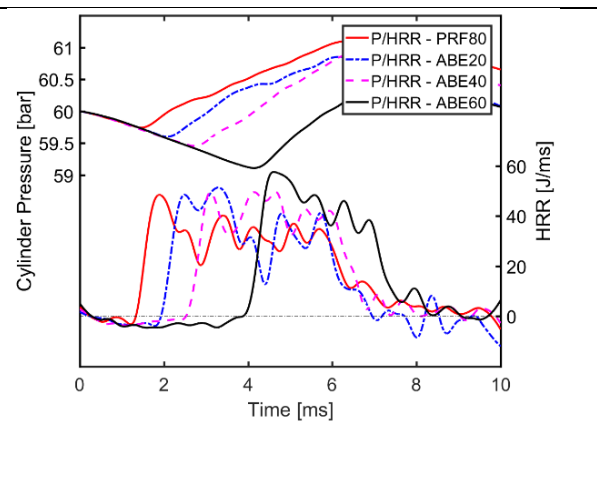
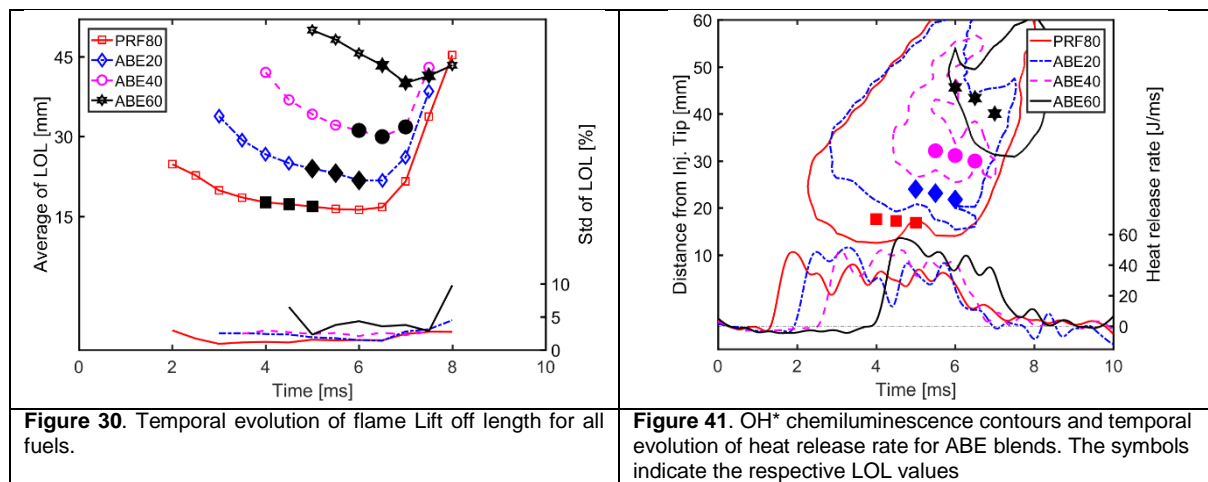

Figure 9. Temporal evolution of in-cylinder pressure and heat release rate for all fuel blends.

The knowledge of the flame lift-off length (LOL) is helpful as it is one indicator of the time needed for the air/fuel mixing before the ignition. The results are plotted in Figure 10 as a function of the combustion development. Initially, the combustion takes place first far from the injector tip and then slowly approaches; then, fast farther away the injector tip. That means that after the first combustion development, the flame expands in forward direction of the fuel injection and, after the end of the fuel injection, i.e. 6.5 ms, the combustion process continues for a relative long time but in a narrow zone. The values of LOL, represented as highlighted black symbols in Figure 10, are plotted in Figure 11 in order to compare with the OH* chemiluminescence contour. It can be seen that as a function of the ABE amount, the stable region of flame stabilization is more and more narrow.



Last, in Figure 12, the LOL is plotted versus the ID: as in the case of Diesel type fuel spray, the linear relationship between these both combustion parameters is confirmed. The data of butanol blends are also plotted and a very good agreement is obtained and confirms that ABE can be used in gasoline blend as butanol until 40% and will be certainly an effective way to reduce the bio-butanol cost. But there is a limitation of that as at higher amount the ignition delay and the LOL are strongly affected by ABE properties in comparison of butanol.

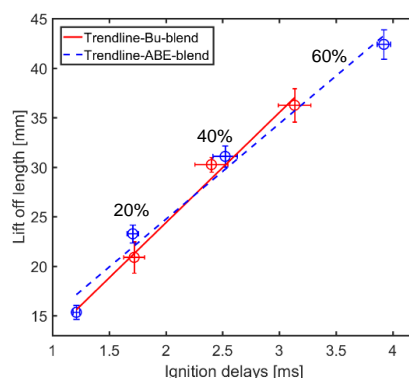

Figure 52. Lift off length versus ignition delays for all ABE and butanol blends in PRF80.

5. Conclusion

In this study, the combustion of Acetone-Butanol-Ethanol blends with a gasoline surrogate, PRF80 with a range of ABE amount (0,20,40, and 60%vol.) was investigated in High temperature and High pressure Spray A conditions, suggested by Engine Combustion Network focused in Gasoline Compression Ignition mode, so with a 400 b injection pressure. Besides the operating conditions, Ignition Delay is strongly influenced by the fuel properties of blends due to the different reactivity and latent heat of vaporization of ABE. The combustion development also indicates that the combustion duration and especially the ratio between premixed and diffusion phases are different with high amount of ABE, even if the stoichiometric premixture is reached far from the injector.

As in the case of conventional diesel spray, the lift-off length of flame is linearly linked to the ignition delay and therefore increases with the ABE amount. The OH* chemiluminescence contours indicate how the flame is narrower as a function of the ABE increase. The decrease of the combustion duration with the increase of ABE ratio is not only related to the ABE oxygen content but also related to a longer flame lift-off length that decreases the local equivalence ratio in the combustion region and the decrease of local temperature due to the stronger cooling effect. The comparison with Butanol blends suggests that ABE can be a good substitute to butanol and can allow the development of ABE as a future alternative biofuel for transportation. But from these first results, it seems that the balance between the effect of chemical and physical parameters on combustion parameters induces a kind of

disruption for higher ABE amount. For that, first, kinetics simulation will be done in order to predict the behaviour as a function of ABE content and next experiments will be done for different blends with ABE content range between 40 and 60%.

Acknowledgements

Authors would like to thank the Ministry of Education and Training of Vietnam for financing the program of Ph.D of Nguyen Tung Lam at University of Orleans; the French National Research Agency (contract ANR-14-CE22-0015-01) and Region Centre Val de Loire and FEDER (CPER 2007-2013 Energies du Futur) for financial support to build the experimental set-up. They want also to acknowledge Y. Haidous and B. Moreau for all their technical helps for the set-up.

References

- [1] Wu M, Wang M, Liu J, Huo H., *Biotechnol Prog* 2008;1204–14.
- [2] Feng X, Huo M, Lee C-F, Liu H. *SAE Int J Engines* 2012;5:794–811.
- [3] Liu H, Lee CFF, Huo M, Yao M. *Energy and Fuels* 2011;25:3192–203.
- [4] Rakopoulos DC, Rakopoulos CD, Hountalas DT, Kakaras EC, Giakoumis EG, Papagiannakis RG. *Fuel* 2010, 89, 2781
- [5] Siwale L., Kristóf L., Adam T., Bereczky A., Mbarawa M., Penninger A., Kolesnikov A., *Fuel* 2013, 107, 409–418.
- [6] Liu B, Cheng X, Liu J, Pu H. *Fuel* 2018;223:1–11.
- [7] Lee TH, Lin Y, Meng X, Li Y, Nithyanandan K. *SAE paper* 2016-01-0884.
- [8] Chang YC, Lee WJ, Lin SL, Wang LC. *Appl Energy* 2013;109:182–91.
- [9] Nithyanandan K, Zhang J, Li Y, Wu H, Lee TH, Lin Y, Lee C.F. *Fuel* 2016;174:333–43.
- [10] Li Y., Ning Z., Lee C.F., Yan J., Lee T., *Energy*, 2019, Volume 168 : Pages 1157-1167
- [11] Wu H, Nithyanandan K, Zhang J, Lin Y, Lee TH, Lee C F, Zhang C. *Appl Energy* 2015;149:367–78.
- [12] Zhou N, Huo M, Wu H, Nithyanandan K, Lee CF, Wang Q. *Appl Energy* 2014;117:104–15.
- [13] Wu H, Nithyanandan K, Zhou N, Lee TH, Lee CF, Zhang C. *Fuel* 2015;142:109–16.
- [14] Nilaphai O, Hespel C, Chanchaona S, Mounaïm-Rousselle C. *Fuel* 2018;225:542–53.
- [15] Nilaphai, O., Ajrouche, H., Hespel C., Moreau B., Chanchaona S., Foucher F., Mounaïm-Rousselle C., 28th Conference on Liquid Atomization and Spray Systems, ILASS–Europe 2017, 6-8 September 2017
- [16] Engine Combustion Network : <https://ecn.sandia.gov/diesel-spray-combustion/target-condition/spray-ab/>
- [17] Li Y., Tang W., Chen Y., Liu J., Lee C. *Fuel*, 2019, 242: 673-686.
- [18] Nilaphai O, Phd thesis, University of Orléans, October 2018
- [19] Mounaïm-Rousselle C., Foucher F, Labreche A., *SAE technical Paper* 2013-01-2532
- [20] Ktrašnik T, Trenc F, Oprešnik SR. *J Eng Gas Turbines Power* 2006;128:928.
- [21] Asad U, Zheng M. *SAE technical paper* 2008-01-1000.
- [22] Payri R, Viera JP, Gopalakrishnan V, Szymkowicz PG. *Fuel* 2017;199:76–90.
- [23] Siebers D., Higgins B., *SAE Transactions Vol. 110, Section 3: Journal of engines* (2001), pp. 400-421
- [24] Benajes J, Payri R, Bardi M, Martí-Aldaraví P. *Appl Therm Eng* 2013;58:554–63.

Nomenclature - Abbreviations

HRR	Heat release rate [J/ms]
SOC	Start of combustion [ms]
SOI	Start of injection [ms]
ID	Ignition delay [ms]
LOL	Liff-off length (mm)