



**HAL**  
open science

# Holistic framework for land settlement development project sustainability assessment : comparison of El Hierro Island hydro wind project and Sivens dam project

Anastasia Roth, Vincent Gerbaud, Marianne Boix, Ludovic Montastruc

## ► To cite this version:

Anastasia Roth, Vincent Gerbaud, Marianne Boix, Ludovic Montastruc. Holistic framework for land settlement development project sustainability assessment : comparison of El Hierro Island hydro wind project and Sivens dam project. *Computers & Chemical Engineering*, 2017, 100, pp.153-176. 10.1016/j.compchemeng.2017.02.002 . hal-03514542

**HAL Id: hal-03514542**

**<https://hal.science/hal-03514542v1>**

Submitted on 6 Jan 2022

**HAL** is a multi-disciplinary open access archive for the deposit and dissemination of scientific research documents, whether they are published or not. The documents may come from teaching and research institutions in France or abroad, or from public or private research centers.

L'archive ouverte pluridisciplinaire **HAL**, est destinée au dépôt et à la diffusion de documents scientifiques de niveau recherche, publiés ou non, émanant des établissements d'enseignement et de recherche français ou étrangers, des laboratoires publics ou privés.



## Open Archive TOULOUSE Archive Ouverte (OATAO)

OATAO is an open access repository that collects the work of Toulouse researchers and makes it freely available over the web where possible.

This is an author-deposited version published in : <http://oatao.univ-toulouse.fr/>  
Eprints ID : 17496

**To link to this article** : DOI: 10.1016/j.compchemeng.2017.02.002  
URL : <http://dx.doi.org/10.1016/j.compchemeng.2017.02.002>

**To cite this version** : Roth, Anastasia and Gerbaud, Vincent and Boix, Marianne and Montastruc, Ludovic *Holistic framework for land settlement development project sustainability assessment: comparison of El Hierro Island hydro wind project and Sivens dam project.* (2017) Computers & Chemical Engineering, vol. 100, pp. 153-176. ISSN 0098-1354

Any correspondence concerning this service should be sent to the repository administrator: [staff-oatao@listes-diff.inp-toulouse.fr](mailto:staff-oatao@listes-diff.inp-toulouse.fr)

# Holistic framework for land settlement development project sustainability assessment: Comparison of El Hierro Island hydro wind project and Sivens dam project

A. Roth, V. Gerbaud\*, M. Boix, L. Montastruc

Laboratoire de Génie Chimique, Université de Toulouse, CNRS, INPT, UPS, Toulouse, France

## A B S T R A C T

*Keywords:*  
Framework  
Eco-energy system  
Multi-stakeholders  
Multiperspective design

Project developer in the domain of land settlement project are involved with many stakeholders and are usually overflowed by data relative to technical, economic and social issues. This paper contributes to the necessary multi-scale approach challenge and we propose a holistic framework that enables to describe the development process of land settlement project and assess its sustainability. It would help developers to take decisions compliant with the project complexity. In the model driven engineering perspective, the metamodel framework is described with the ISO 19440 four views to represent complex systems: architectural, structural, functional and behavioural. We confront it to describe two case studies: the successful project of hydro-wind power plant in El Hierro in the Canaries, and the Sivens Dam project in France sadly famous for its deadly outcome. Their comparison enables us to draw hypothesis on what are the ingredients of success and validate the framework.

## 1. Introduction

Among the three pillars of sustainable growth, economics, society and environment, the involvement of people is the least easy, especially in engineering-based projects. In the academic context where interdisciplinarity is strongly encouraged, interdisciplinary teams are complicated to set up and make running. In the industry context, if customers' concerns are scrutinized with care when making engineered products, the implication of all stakeholders is not a settled issue. Even if, one identifies needs and contexts for consumer involvement in sustainable technology development, "Transmitting the consumer's voice into product development is another challenge that is not automatically solved by consumer participation" (Heiskanen et al., 2005). Besides, other stakeholders are not systematically consulted although they might be impacted, like inhabitants in land settlement projects and may oppose firmly the project, leading to delay at best and cancellation at worst. The people concerned by any engineered project are numerous: customers, company's manager, marketer, engineers, operators, and, near the production factory site, local stakeholders: elected representatives, inhabitants, environmental associations. . . Those people are intrinsically different in terms of backgrounds, qual-

ifications, roles and power, which complicates interdisciplinary interaction and taking decisions.

Buchholz et al. (2009a) stated that sustainable bioenergy systems ". . . are, by definition, embedded in social, economic, and environmental contexts and depend on support of many stakeholders with different perspectives". The resulting complexity holds for any land settlement project and especially the ones involving systems based on renewable resources. Besides any such development project is a sequence of activities that does qualify as being a process. From the Process System Engineering (PSE) perspective, that complexity can be translated as a multi-objective optimization problem embedded into a decision support framework. The PSE solutions should transcend the simple selection of the best technico-economic solution, but unfortunately, it may remain anchored in technico-economics with some arbitrary description of social and environmental issues as mathematical constraints. Indeed, we postulate that any engineering design process that primarily concerns technology should also always be run in good intelligence with other issues relative to people, ecosystems and macroscale economics to be successful. That is why we use a model driven engineering (MDE) perspective. In MDE, the complexity of any problem is handled by considering modelling layers of abstraction that distinguish metamodel and model layers and confront them to the real system through a case-specific implementation layer. We set our proposal at the metamodel level of abstraction with the intention to develop a metamodel level framework. In

\* Corresponding author.

E-mail address: [Vincent.Gerbaud@ensiacet.fr](mailto:Vincent.Gerbaud@ensiacet.fr) (V. Gerbaud).

the future, a possible software implementation will belong to an abstract implementation layer and a possible use of that software for a case-study would belong to a case-specific implementation layer. Nevertheless, we can still use the metamodel framework on past case studies for describing them and evaluate the framework capability to do it with acceptable accuracy.

The article is structured as follows: after a state-of-the-art section §2, section §3 gives prerequisites notions used to develop the framework, section §4 presents the framework based upon the four enterprise views, section §5 apply the framework to two case studies: El Hierro energy project in The Canary Islands and Sivens dam project in France. The comparison between the two case studies allows us in the discussion (section §6) to draw hypothesis about the human factor importance in increasing the success rate of development process in renewable resources exploitation projects.

## 2. State-of-the-art

[Buchholz et al. \(2007\)](#) recalled that modelling social, economic, and ecological components of bioenergy systems requires defining suitable criteria to assess sustainability and embedding them in a multi-criteria analysis approach. [Azapagic et al. \(2016\)](#) widen that perspective and propose to use “life-cycle thinking” within a system approach supported by a decision-support framework to practice effectively sustainable engineering addressing all three pillars of sustainable growth: economics, society and environment.

The sustainability criteria issue is very well documented. But it is rarely agreed as most sustainability problems are “wicked” in the sense of being difficult to define univocally and solutions proposed are difficult to describe fully, assess and test ([Azapagic and Perdan, 2014](#)). As an illustration of that, [Buchholz et al. \(2009a\)](#) asked experts to rank 35 criteria to assess sustainability. The top 12 criteria in terms of importance concerned environment (7), social issues (4) and economics (1) but 7/12 ranked low in practicality and reliability. For solving the practicability of criteria, [Dale et al. \(2013\)](#) gave a short list of 16 indicators claimed as practical since they could be assessed unambiguously. They were classified among 6 categories, including 8 social indicators that were split between Social well-being (employment, income, work safety and food security indication) and Social acceptability (public opinion, transparency, effective stakeholder participation, risk of catastrophe).

The multi-criteria analysis (MCA) issue is also thoroughly studied and we are here interested in those with stakeholder involvement. [Buchholz et al. \(2007\)](#) advocated using MCA to implement a model assessing the sustainability with a participatory approach. Later in 2009, they noticed that “in a decision assisted by MCA, stakeholders can contribute to various steps in the process: (i) model building and criteria selection, (ii) selection/description of scenario, (iii) criteria weighting and/or, (iv) scenario ranking” and compared how it was done in four popular MCA tools ([Buchholz et al., 2009b](#)). In the same vein, [Cherni et al. \(2007\)](#) proposed the model SURE that includes stakeholders in the third and fourth step aforementioned. [Mendoza and Prabhu \(2005\)](#) suggested combining MCA tools and participatory modelling to include stakeholders in the first step. [Scott et al. \(2012\)](#) broader review of multi-criteria decision-making (MCDM) methods in 57 papers studying bioenergy systems gave useful results: nearly 72% dealt with optimizing the system, 13% concerned qualitative/stakeholder interview “to focus on identifying success criteria and collect detailed opinions of key stakeholders”, and 10% predicted future patterns of renewable implementation or energy use. Regarding the application areas, nearly 40% of the papers dealt with technology selection, 25% with policy decisions (to measure impacts or makes recommendations), and 21% (12/57) concerned sustainability criteria covering environment, social and economic issues. In the 12 papers dealing with

sustainability, 9 used it to select or compare technology alternatives. Sustainability assessment method was usually carried out in two ways, either in evaluating a global set of indicators or in trusting local actors to evaluate sustainability in the local context.

The trend observed by [Scott et al. \(2012\)](#) about the major focus of the bioenergy system literature on technological optimization is confirmed as it occurs for many other diverse sustainability problems, whether it be for designing and sizing models of wind farm with water storage system ([Buono and Carta, 2004](#)), for the smart power management of photovoltaic/wind/electrical and water storage ([Zaibi et al., 2014](#)), for the design of biorefineries ([Geraili et al., 2014](#)).

What seems to be missing in our opinion is a holistic approach that would gather expert knowledge in social, environment, economy, and engineering areas and that would be generic enough to apply to any development process, incl. chemical engineering plant installation, although we illustrate it with land settlement project here because of more information about the social issue. Part of the difficulty lies in the difference in approach, concepts and methods between social, economic, environmental and engineering sciences.

On one hand, in social sciences, most works related to engineering projects deal with the measurement of the acceptability of technical devices after they are designed. For instance, [Phillips-Bertin et al. \(2015\)](#) measured the acceptability of electric vehicles whereas [Baud and Couturier \(2015\)](#) deal with the acceptability of new regulation policies in intelligent office buildings. But the true challenge lies in studying acceptability in line with the development process. For that goal, methods to facilitate participatory process have been proposed, like the ESTEEM method aiming at managing societal acceptance in new energy projects ([Raven et al., 2009](#)). Another one is the Companion Modelling method ARDI (Actor, resources, dynamics, interactions) ([Etienne et al., 2008](#)). We remark incidentally that the four ARDI steps are indubitably close to the ISO 19440 standard recommendations for representing the enterprise by using four views ([ISO 19440, 2005](#)): organizational (enterprise structure), resource (resource, capability), functional (event-process-activity) and informational (object-data) ([IEEE, 2000](#)) that we use in this paper to build our framework. In the context of wind energy projects, an International Energy Agency expert group stated that there exists no holistic approach to deal with social acceptance of any project ([Huber and Horbaty, 2010](#)) but they could ultimately finalize a set of recommended practices for improving social acceptance by addressing five issues: (1) policy and strategy framework; (2) well-being and quality of life; (3) individual evaluation of the project cost-benefits; (4) consultation and involvement of local stakeholders in the decision-making process; (5) implementations strategy to overcome pre-set ideas ([Huber and Horbaty, 2013](#)). Those issues can be categorized differently according to a spatial hierarchy: macro scale wind turbine sector; meso scale where the developer operates, local scale where the project will be implemented.

On the other hand, in engineering science to which belongs the PSE system approach, sustainability problems are handled in a mathematical and quantified way: for example, [Sharma et al. \(2013\)](#) considered stakeholder value across the multiple product biorefinery supply chain through quantifiable variables. They related customer satisfaction to production achieved; investor’s appreciation to minimum interest and dividend payments; and farmer’s concern for a reliable income source to land utilisation. In a review by [Boix et al. \(2015\)](#) on the development of eco-industrial parks, different alternatives to consider the degree of satisfaction of participants have been proposed by several authors incorporated social benefit of biorefineries as quality of life to direct job creations ([You et al., 2012](#); [Santibañez-Aguilar et al., 2014](#)) or to direct, indirect and induced jobs creation ([Miret et al., 2016](#)).

As mentioned above, some of the wickedness of sustainability problems lies in the difficulty for stakeholders to agree upon the problem definition and upon the evaluation of the alternative solutions proposed. Solutions are now rising: Dowling et al. (2016) optimized a facility location problem by introducing the concept of the conditional-value-at-risk norm so as to propose Pareto optimal solutions without having to confront stakeholders' biased and often opposite opinions in choosing the final solution. Besides, some solutions have been proposed in system engineering to minimize ambiguity, say in defining products requirements. In system engineering, whether enterprise wide or process wide, the most effective frameworks are built to ensure strategic alignment across the enterprise decision-making layers and enable their practical implementation with so-called horizontal alignment supporting the coherency of information across the modelling layers (Vernadat, 2002). For that double purpose, model driven engineering (MDE) concepts and languages are welcomed (Perez et al., 2008), like the ISO 19440 standard recommendations for representing the enterprise aforementioned and the Unified Modelling Language (UML) that will be briefly described later. For example, Hung et al. (2008) used MDE concepts to propose a framework to overcome the difficulties of interdisciplinary works for product design inside companies, enabling to take into account the diversity of people involved so as to translate customer needs and engineering requirements into product requirements with the help of Quality Function Deployment techniques. At the same time they addressed product design scheduling and costing issues with the help of the Design Structure Matrix representation. In the same vein, several authors developed a multi-layered decision-making methodology for designing sustainable chemical products within a chemical company (Heintz et al., 2014) or designing renewable energy production systems (Geraili et al., 2014) or biorefineries (Sharma et al., 2013) which can integrate activities at the strategic, tactical, and operational levels. Heintz' methodology incorporated stakeholders at various stages. It followed the usual decision-making process of Simon (1960): an intelligence phase gathers relevant information to build the requirements tree, a design phase designs the chemical product, a choice phase asks experts to choose the most suitable solution, and an implementation phase deals with the manufacturing. Modelled with UML and business process modelling notation (BPMN), Heintz' framework makes use of unambiguous languages like Semantics of Business Vocabulary and Rules (SBVR) (OMG, 2008) and Object Constraint Language (OCL) (OMG, 2006) to express customers' preferences and designer's opinion in the building of a requirements tree for the product. People belonging to the different layers in the company hierarchy are also involved to fulfil the vertical alignment. Related to strategic, tactical and operational decision levels, they bring different opinions about what a suitable final product would be. Later experts are consulted to select the best alternative.

Finally, adopting a Process System Engineering approach, You and his colleagues have studied the optimal design of supply chains dealing with bioenergy systems. He has shown opportunities and raised three crucial challenges relevant to the design of projects exploiting renewable resources, such as those we consider (Yue et al., 2014; Garcia and You, 2015): multi-scale challenges, multi-objective and sustainability challenges, and multi-player challenges.

The first multi-scale challenge is linked to the need to model information flows at multiple spatial and temporal scales, to carry out a simultaneous optimization over those scales, to understand and analyze the consequences of uncertainties and to do so with efficient algorithms and computational resources.

The second multi-objective and sustainability challenge was discussed above. It concerns issues of defining proper criteria over

all three pillars of sustainable growth and issues of performing the optimization across the whole project life-cycle.

The third multi-player challenge was also discussed above and it raises the question of an adequate participation of stakeholders, at the right time in the development process, and with suitable tools for modelling participatory processes.

In summary, Table 1 sums up the literature that we discussed and compares our proposal according to the focus, methods and tools and the domain addressed. Most works concern the assessment of the sustainability of technologies or products (using criteria inventory, MCA methodology, decision making support. . .). Others address the challenges of a design compliant with sustainability and propose multi-objective optimization, and finally some deal with participatory processes to ensure a sustainable development process.

Our proposal is very close to Buchholz's one in 2007 as we address the same focus and concern, namely the Development process and assessment of technic in regards or social/society, economy, environment, and people participation. But in Buchholz et al. (2007) only describe what is needed "to decide when, where, and how bioenergy systems can contribute to development" and keep explaining that to do so "we need a planning and evaluation tool", and later state that it should bear a holistic view. Our modelling framework proposal heads in that direction. Following model driven engineering precepts, we remain at a metamodel level and we do not here present any specific implementation although we use real case studies for illustration. The purpose of the framework is then primarily descriptive to aggregate holistic knowledge on the development process. A future implementation based on artificial intelligence concept is in progress. It will be carried out by a workflow supported by an inference motor of an ontology derived from Benaben's core ontology (Bénaben et al., 2016, 2015). His ontology was developed in the context of crisis management around a core metamodel that describes all systems where collaborative situation with multiple stakeholders holds.

### 3. Prerequisites

We describe some notions and concepts useful to understand the development of our framework.

#### 3.1. The notion of system and our "global system"

In line with the General System Theory (Von Bertalanffy, 1968) we use the notion of "system" which is a set of elements structured, organised, auto-organised, and regulated elements, where information and/or energy and/or matter can be exchanged inside the system or with the environment of the system. In this paper, we called "global system" a place – or an entity – where a project based on engineering activity is under way. This project can be either a land settlement project (building, airport, dam, renewable power plant, . . .) as in our case studies, or any other development project that one would qualify as sustainable.

To define the global system for a development project, one needs to specify several diverse factors that we categorize in five sets:

- 1) Project goals, boundaries and timeline
- 2) Social factors
  - a Stakeholders,
  - b Culture and history of the place,
  - c Politics,
  - d Regulations,
- 3) Economics
  - a Economic activity – agricultural, tertiary, industrial and related costs. . .

**Table 1**  
Overview of literature's work.

Authors	Focus					Methods and Tools	Concern				
	Development process	Design	Optimisation	Implementation	Assessment		Technic	People participation	Social/Society	Economy	Environment
Our paper	yes				yes	UML ISO 19440	Land settlement project	yes	yes	yes	yes
Azapagic et al. (2016)				yes	yes	LCA	Energy production		yes	yes	yes
Boix et al. (2015)			yes			DM framework	Eco-industrial parks				
Buchholz et al. (2009a)		yes		yes	yes	MILP, MINLP, LCA, LCC, MCA	Bioenergy				
Buchholz et al. (2009b)					yes	Criteria inventory	Bioenergy		yes	yes	yes
Buchholz et al. (2007)	yes				yes	MCA	Bioenergy	yes	yes	yes	yes
Bueno and Carta (2004)		yes			yes	Sizing with simulations	Hydro-wind power plant			yes	
Cherni et al. (2007)					yes	MCA	Energy system		yes	yes	yes
Dale et al. (2013)					yes	DM system					
Etienne et al. (2008)		yes				Criteria inventory	Bioenergy		yes	yes	
Garcia and You (2015)		yes	yes			ARDI		yes			
Geraili et al. (2014)		yes	yes			-	Supply chain			yes	
Heiskanen et al. (2005)	yes				yes	LP, NPV, simulation	Renewable energy systems				
Huber and Horbaty (2010, 2013)					yes	Usage and consumer test	Sustainable product	yes			
Mendoza and Prabhu (2005)					yes	Policy, well-being, cost benefit	Wind energy		yes		
Miret et al. (2016)		yes			yes	MCA, Participative modelling		yes		yes	yes
Phillips-Bertin et al. (2015)					yes	SWOT	Biofuel supply chain			yes	yes
Raven et al. (2009)	yes					MILP	Electric cars		yes		
Santibañez-Aguilar et al. (2014)			yes			Goal programming	Energy		yes		
Scott et al. (2012)					yes	Scenario methods	Biorefineries		yes	yes	yes
Sharma et al. (2013)			yes			ESTEEM					
You et al. (2012)			yes		yes	MILP	Biorefineries	yes		yes	yes
					yes	MILP	Biofuel supply chain		yes	yes	yes
						DM LCA					

UML – Unified Modelling Language, MILP – Mixed integer Linear Programming, MINLP – Mixed Integer Non Linear Programming, LCA – Life Cycle Assessment, LCC – Life Cycle Cost, MCA – Multi criteria analysis, LP – Linear programming, NPV – Net Present Value, SWOT – Strength Weakness Opportunities Threats, DM – Decision Making.



- b Finance,
- c Global market,
- 4) Resources and production means
  - a Supply chain – raw materials, energy, product selling, waste, ...
  - b Technical choices and technologies used,
- 5) Earth factors
  - a Geographical location – urbanisation. . .
  - b Geomorphology – mountains, reliefs, river, oceans. . .
  - c Climate attributes – wind, sun, rain, latitude. . .

We consider that taking into account the features above is a key factor to carry out projects such as the case studies we will discuss. Some are evidently very far from the usual preoccupations of engineers, mostly related to technology and economics.

### 3.2. Unified modelling language (UML) and object oriented approach

The framework is mainly described with UML2 concepts and tools. UML is a widely used graphical, formal and normalised language. Based on an oriented object approach, it embodies the systemic approach that we prone.

UML allows us to describe systems along the four views as recommended in the ISO 19440 standard recommendations for representing the enterprise (ISO/DIS 19440, 2005); static views: architectural, structural ones, and dynamic views: functional and behavioural ones.

According to oriented object approach concepts, we shall qualify subsystems within the global system aforementioned as interrelated agents in the software sense. An Agent is a component with autonomous behaviour aiming to realize what is it designed for. Components are objects with interfaces and objects bear attributes and methods.

Several diagrams exist in UML2. In the following, we use class diagrams and object diagrams, use case diagrams and activity diagrams.

The architecture and structure of systems can be represented with so-called Class diagrams such as the one presented in Fig. 1. It describes some objects and their relations of renewable energy production technology, as those used in case study 1.

Boxes represent classes, which are categories of objects, for instance an alternator. The higher the class the more general it is. On the contrary the more the class is at the bottom the more it is specific. For instance “Renewable energy production technology” is a general class, while “PV panel” or “Windmill” is a category of specific renewable systems. “Renewable energy production technology” is called a super class and “Windmill” and “PV panel” are called child classes. The unfilled arrows represent a hierarchical relation between classes and always point from child classes towards super classes. They are called inheritance links. The filled arrows stand for a composition relation: e.g. a windmill is composed of 3 blades, 1 alternator and 1 pole. The simple arrows represent directed association, for example the pole supports the blades. Finally, the dash arrows show dependency links. The length of the windmill pole depends on the type of windmill. Each object bears attributes (e.g. total energy production value for the super class) and methods (e.g. produce energy).

When describing a renewable energy systems production technology, we go through this class diagram by instantiating the classes. For example to create a windmill object, we go through the windmill class to instantiate (i.e. create) three blades, one alternator and one pole. By definition, blade n° 1–3 are instantiations of the class “Blades”. UML object diagrams give example of instantiation of class diagram.

The functional view of a system can be represented with a Use case diagram. It depicts from the perspective of a user what the system must perform. In this work, a use case diagram is used to detail the intentions of the project developer.

Finally, activity diagrams are used later to portray the behaviour of the global systems.

### 3.3. Multi-scale approach

#### 3.3.1. Multiple decision levels

Within the simple decision making process of Simon (1960) based upon intelligence, design and choice phases, Ansoff (1965) proposed a classification of decisions into:

- strategic decisions, determining the orientation taken by the enterprise,
- administrative decisions, that structure firm’s resources for optimum performance,
- operational decisions, to optimise fulfilment of the enterprise objectives.

Nowadays, in business management it is a common knowledge to consider that: strategic decisions regard long term guidelines and they are taken by CEO and board of enterprises, tactical decisions are related to the implementations of the strategic decisions and are taken by managers at the middle layer of enterprises, finally operational decisions are day-to-day decisions to face up to daily events. In this paper, we extend this classification to every organization so that its utilization is not only restricted to enterprises.

3.3.2. Multiple spatial and time scales. Added to multi-level decisions, we consider different spatial scales and different temporal scales, listed in Table 2.

The first column refers to a scale of focus on the global system under study. At the macro level the focus concerns the global system and its surrounding as a whole. At the meso level we shall look at the global system with a limited awareness of its surrounding that is acting on the system by a single averaged effect. Finally, at the internal level we look inside the global system in its full detail but we do not pay much attention to the other elements around at higher scales.

## 4. Proposal

Fig. 2 depicts the four phases of the horizontal decision making process. The multiple levels listed in Table 1 are covered in particular in the design phase where engineering activities mostly occurs. Such an horizontal and vertical perspective comes from the process system engineering vision of the horizontal manufacturing and vertical design business processes proposed by Marquardt and Nagl (2004) as they discussed the context of manufacturing and design in the 21 st century. Although their original figure described socio-economic environmental constraints, they did not discuss it anywhere in their article. We stressed in introduction their critical importance and we complete it in Fig. 2 with the geographical context, such as climate, geomorphology and urbanisation and detail stakeholders. The sustainability context is formalized as a set of planets and moons, with a size that is proportional to its importance in an engineering-centred vision. Stakeholders are on another planet, even less connected to the current engineering practice.

We assume that the primary step to address the society challenges towards sustainability nowadays is to change the engineering paradigm. Hence, we propose an alternative engineering paradigm by interrelating the engineering and the socio-environmental context and make the planetary system of Fig. 2 a

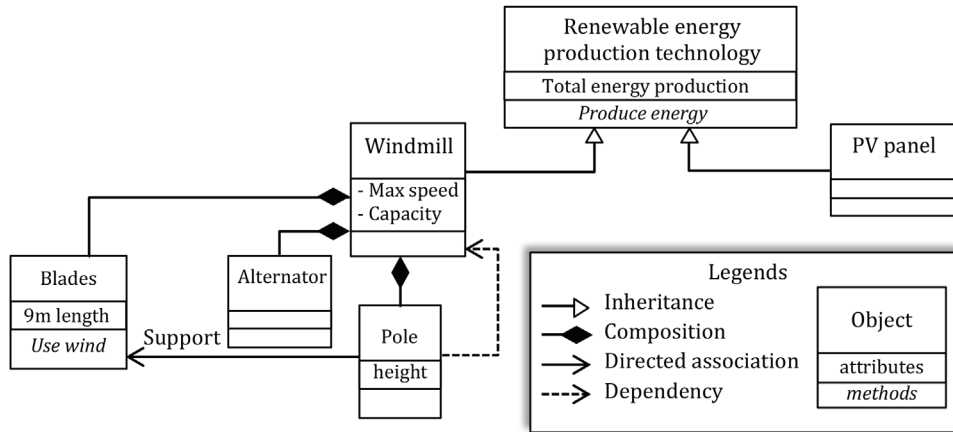

Fig. 1. Example of Class diagram for renewable energy production technology.

Table 2  
multi-level modelling.

Focus scale	Decision levels	Technological systems	Design	Time	Dynamics	Space	Economy
External level							
Macro level	Strategic	Supply chain	Predesign	Project initiation	Decades or years	World	Global market
Meso level	Tactic	Plant	Accurate design	Project definition	Years or months	Country	Investment
Internal level	Operational	Product unit	Sizing	Project realisation	Day, hours, sec	Region	Taxes
						Local	CAPEX OPEX

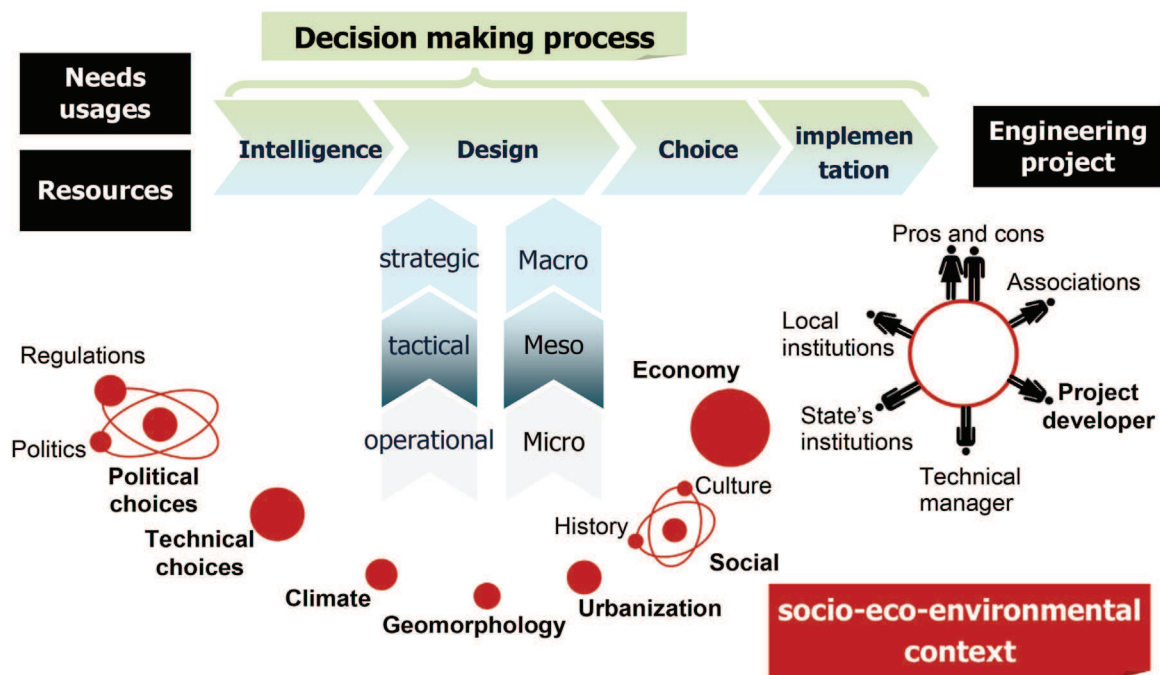

Fig. 2. Engineering-centred vision of an engineering project.

heliocentric system with the engineering project at the centre. The scheme of Fig. 3 symbolises this idea.

The new paradigm and the framework developed below finds its inspiration in the ARDI method developed to support participatory processes and we find the same notions: Actors involved in the Stakeholders sphere, Resources displayed in the information sphere, Dynamics and Interactions in the dynamic description presented later.

For the sake of clarity we have not duplicated issues at all the multiple scales listed in Table 2 but we have rather selected the most relevant level for each issue. Typically, the issue “Economy”

would concern all levels: at the micro level it would be tackled by evaluating operating costs and capital costs, at the meso scale it would include taxes and royalties, at the macro level it would concern loans and investments and at the external level it would be represented by the global economic market evolution. Although it is not our aim in this paper to focus on all economic issues in much detail, esp. the ones related to economics, engineering design and technical choices, we will not forget them later.

As Fig. 3 cannot display the full essence of the framework, in particular the dynamics and the relations, we now use the four



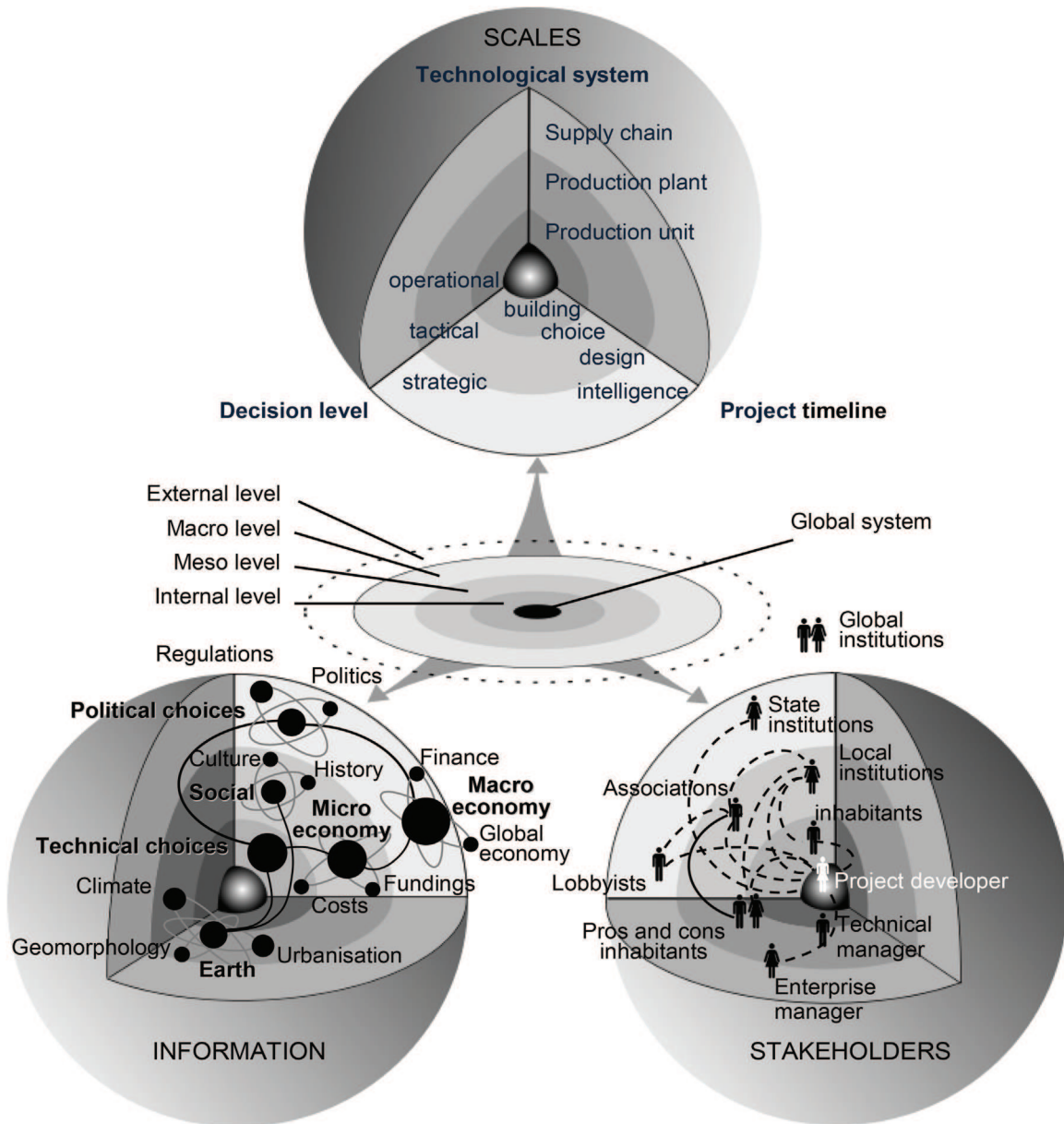

Fig. 3. Holistic scheme of an engineering project.

ISO 19440 standard views with the help of UML to overcome this limitation.

#### 4.1. Static description – architectural view

Here, we describe in a static way the architecture of the scheme displayed in Fig. 3. The scheme represents different aspects of the development project seen as a global system. Each cross-section sphere represents an aggregation of agents in the UML sense (see Section 2.1.2). Hence, the engineering project is the global system at the core. It is seen as an ecosystem of three sets of agents, namely “information”, “stakeholders” and “scales” that are related across the multiple layers enounced in Table 2. Elements of each sphere are also agents. They interact all together and make the global system evolve.

All the factors relevant to a development project categorized in five sets in Section 3.1.1 are represented as agents and aggregated in the bottom left INFORMATION sphere. Choosing the term information avoids us to explicit the different physical represen-

tations of each issues. Besides, information is what the project developer has access to, and needs to conduct the process to a success. Evidently information remains an approximate representation of reality. Stakeholders are extracted from the social factor and made explicit in a specific STAKEHOLDER sphere in the bottom right of Fig. 3. We have stressed in introduction the importance of the human factor in determining the success rate of a project and we will show in the next section the complex structure underlying the agents in that sphere. The SCALE sphere at the top partially describes the development process, showing how the timeline, the decision-making process and the technical choices also require attention at all macro, meso and internal levels of the project global system.

Around the global system core, the internal, meso and macro level orbits encompass issues that affect the development process, directly, loosely or indirectly. Typically for a land settlement project, the internal level is the site location, the meso level is the town and surrounding area and the macro level is the state and the country. Some elements can also gravitate outside the spheres in

the external level that represent for us the international context. For instance a Wall Street krach, a breakthrough in renewable energy research, a drop of oil price. . . would definitely impact development projects. The arrows in the middle of Fig. 3 point towards the three agents to illustrate their links. They will become more explicit in the behavioural description of the two case studies at the end of the paper.

In Fig. 3 we have distinguished the stakeholders (in the Stakeholder sphere) from the decisions (in the Scale sphere) to stress out that once decisions are taken by people or affect them, they persist independently of the people and drive the evolution of the global systems. We will see it on the case studies.

Another aspect of the complexity of a global system that was pointed out in the literature is the temporal dynamics differences between the agents that we consider in the Information sphere. Their dynamics are summarised in Table 3 and could be considered properly in a multi-objective multi-period optimization scheme, out of our present scope.

The three Stakeholder, Scales and Information spheres interact as follow: for instance, in response to a need formalized by the urbanization agent involving inhabitants, the project developer at the core of the Stakeholder sphere triggers the project and gathers information from the Information agents. Some information requires involvement of other stakeholders at various scales: urbanisation involves local institution (Mayor, town council, country council); regulations involve state institution; social acceptance involves inhabitants, local politicians, associations, pro and cons; etc. As the timeline goes, decisions are taken by the project developer in accordance with the company's managerial staff at the strategic, tactical and operational levels that concern essentially macro, meso and internal level issues respectively. Eventually the project development process is successful: the project is build and operated. The project life cycle goes on until its dismantling. Links between each elements (or agents) of issues and stakeholders agent will be presented in the following structural view of the framework structure. Dynamics of the interaction will be made explicit later in the behavioural view.

#### 4.2. Static description – structural view

The Fig. 4 UML class diagram displays composition relations between the classes that represent each agent sketched in Fig. 3 and belonging to the Information and Stakeholders spheres. The Scale sphere agents are simpler and are not described. When dealing with any sustainability related project, it is expected that all those general classes should be involved. If not, it may be because the modeller does not have a holistic enough view of the process under study.

The structure between the Information agents is simple and describes links of composition between the classes referring to the agents. Inheritance links are shown with instantiations of general classes to help the reader imagine what is under the terms “Political Choice”, “Climate”, “Geomorphology”, etc. . . .

The structure between the Stakeholders agents is more complex. In addition to composition and inheritance links, we distinguish dependency and association links: Dependency links (dash lined arrow) represent distrust relations. They mean that one of the actors involved in the relation take a critical look at the behaviour of the other one. Typically, it is the relation between project developer and local population. As inhabitants don't want their daily life to be jeopardized; a link of distrust is established towards the project developer. Other relations may be more cooperative and association links are used to represent association relations between actors, for example associations and inhabitants.

Notice that the Information sphere's structure will often be the same from one project to another one, but the stakeholders sphere's structure may vary a lot.

#### 4.3. Dynamic description – functional view

The functional view displayed in Fig. 5 aims at describing in our case the intentions of the project developer, its objectives.

It allows us in particular to follow the development process from the developer's point of view. Hence, after the initiation step, one finds the four classical decision making phases of Simon: intelligence, design, choice and implementation phases. In accordance with the literature review, participation of stakeholders is strongly encouraged: consulted for assessing the needs, involved in a participatory process to define criteria weights, consulted during the scenario choice, along with experts. Notice that during the intelligence phase an actor's game is played, which can be useful to evaluate pros and cons arguments and adapt the participatory process during the design phase.

#### 4.4. Dynamic description – behavioural view

Fig. 6 describes the behaviour of the system with the help of an activity diagram that spans the development processes timeline along its horizontal axis, following the Simon's decision making phases discussed in the use case of the previous section. Vertically, the process goes through the different levels and spheres of interest. The sheet icon symbolizes documents produces during the process. They enact the capitalization of knowledge during the project.

Regarding the Information and Stakeholders spheres, we add a “global” label. It stands for considering at once internal, meso and macro levels when an event affects an agent globally. For instance, a new regulation removes limitation of windmills number in wind turbine farms. Such a macro-scale political choice will affect technical choices and economy at both the meso and internal levels.

The behavioural diagram will be exemplified below in the case studies.

In summary of the proposal section, the context and the actors of global systems are described thanks to architectural view, the links between the context elements and between the actors are depicted with the structural view. The intentions of the project developer are formalized with the functional view and finally the “life” of the global system can be described dynamically thanks to the behavioural view.

### 5. Application of the framework on the case studies

#### 5.1. Case study of El Hierro in The Canaries

##### 5.1.1. Overview of El Hierro's case study

El Hierro Island is included in the archipelago of Canary Islands in Spain. It became world famous for its ambition to become the world's first energy self-sufficient island, driving with 100% renewable energy. The inauguration of a wind and water turbine farm in June 27th, 2014 achieved a long process of mutation. Gioda (2014) has given a good overview of the project and its evolution from the beginning until the end. Being an isolated network, the island energy demand reached 44.6 GWh in 2011 and as provided originally by a fuel power plant, required 9.812 t of diesel fuel per year at that time (Godina et al., 2015).

As the most remote island from the continent in the archipelago, El Hierro Island didn't become a vacation spot like the other islands of the archipelago. Hence the 11,000 inhab. population of El Hierro (near 8000 permanent) is accustomed to an independent life.

In the 90's, the Spanish army made public its project to settle a military radar base on the island (Gioda, 2014). Indeed, it has a

**Table 3**

Functions, level of concern and time scales of sustainable issues.

Level of concern	Agents	Functions	Time scales
Macro level	Political choices Economy	Sets life rules Gathers fluxes of added values going through the global system	>>years or decades weeks to months
Meso level	Climate Geomorphology Urbanisation  Social	Out of control and sets constraints on the global system Represents a need to be satisfied (electricity, water, infrastructure...) Represents local culture and history that influence global systems	>>Centuries. Can be considered as no evolving. Years  >>decades for changing cultural response
Internal level	Technical choices	Should satisfy urbanisation needs in harmony with social issues and in a sustainable way	

strategic position in the Atlantic Ocean and it wasn't a very active place in terms of economic activities. The radar base would boost them. Nevertheless, this project confronted directly El Hierro's culture of independency and it happened to trigger two transitions in the island, one ecological and one about energy.

The first ecological transition concerned the 1997–2006 period. In 1997, the island Council of El Hierro published a Plan for Sustainable Development (ENDESA, 2014) that included the creation of a UNESCO Biosphere Reserve and the creation of a hydro-wind power plant. UNESCO Biosphere Reserve label was given in 2000 (Gioda, 2014). It recognizes El Hierro as a model in term of sustainable development and biodiversity conservation. So, it made El Hierro radiate internationally. The island council plan was reviewed in 2006 with some propositions on territorial, social, environmental, economical, and technological levels (Atlantida et al., 2006). Locals were notably consulted to express their opinion on the plan.

The second energy transition is in progress since 2004. The goal behind the energy transition was to become energy independent from the existing fuel power plant. In 2004, the so-called "Gorona del Viento" company was created to design, develop, and build a hydro-wind power plant. This society is owned at 60% by the Council of El Hierro, 30% by the Spanish national electricity company ENDESA UNELCO and 10% by the Technological Institute of the Canaries. In 2007, the cost of the project was estimated at 60.6 M\$, and it was revised upwards to 72.2 M\$ in 2009. Finally, the project total cost reached 89.3 M\$ at the time of the plant inauguration in 2014. Gorona del Viento funded 60% of this amount, while subsidies from Spain and Europe paid for the 40% remaining. Today, this society remains the administrator of the plant, while ENDESA UNELCO is the operator.

The hydro-wind power plant is composed of five wind turbines of 2.3 MW and of a water storage tank. The water storage system allows smoothing windmills production curves in order to adapt to the demand. There is one upper reservoir of a capacity of 500.000 m<sup>3</sup> and a lower reservoir of 150.000 m<sup>3</sup> separated by a height of 700 m. If the power of the wind becomes insufficient to meet the demand, four Pelton water turbines, of a total power of 11.3 MW, take over to produce hydroelectricity between the two reservoirs. In addition, the fuel power plant remains always active to ensure electricity production in case of a shortage. Its new production capacity is now reduced to 13.7 Gwh, down from 44.6 Gwh before 2014, saving nearly 6000 t of diesel per year, at 1.8 M€/year. The system currently satisfies the electricity demand of the island – estimated at 45.4 GWh for 2015 (Godina et al., 2015).

Although the initial goal of 100% renewable production of electricity will likely remain an utopia, all agree that this project is an on-going success. Besides, it stands as a model in terms of stakeholder involvement which leads to no opposition. It is due to a suitable combination of public opinion and political choices. In fact, the army base project settlement incursion of the Spanish army was felt as incursion from strangers that would impose to them

and remove their control on their way of life. Indeed, since the local distributor of electricity was a Spanish mainland company, if in addition the Spanish army would settle on the island, it would be controlled by the Spanish mainland. So to be emancipated, local population and politicians reacted by developing together the ambitious project of hydro-wind power plant to become energy self-sufficient. They brought the project under the light of an international audience, so as to improve El Hierro's image in a unique and positive symbol, and gather subsidies from Europe as well.

Let's use our framework now.

#### 5.1.2. Static description – architectural view

The global system that we consider is the El Hierro Island during its two transition steps from 1997 to 2014. Fig. 7 represents the model of the El Hierro system. Its architecture is quite similar to the one described in the proposal section, with adaptations to the Information and Stakeholder's spheres. Several elements are shown in the external layer: "Spanish army incursion", the element that triggered all the El Hierro transition processes, and "Subsidies", that come from EU and Spain.

Gioda (2014) listed the main actors involved in the El Hierro transitions. Thanks to this paper, Stakeholders agent can be described as follow:

- At the internal level there are:
  - The Gorona del Viento company which developed the project.
  - Gonzalo Piernavieja Izquierdo, scientific director of the project, acting as technical manager (see Fig. 1).
- At the meso level:
  - The ENDESA UNELCO spanish electricity company that owns and operates the fuel power plant on El Hierro Island.
  - The Council of El Hierro, represented by its president, Tomás Padrón. That person was earlier an engineer at ENDESA UNELCO in charge of the fuel power plant.
  - Don Zósimo, the Director of the forest rangers of El Hierro. He worked to promote the ecological transition and to obtain the classification of El Hierro as a Biosphere Reserve.
  - The local population is an important actor that is the final user of electricity but also lives near the power plant.
- At the macro level:
  - Isidóro Sánchez, the Director of the National Parks of The Canaries, and also a Deputy at Regional Parliament of The Canaries and at the European department.
- At the external level:
  - Isidóro Sánchez as a Deputy to the European Parliament.
  - The Man and Biosphere Program (MAB) of UNESCO that delivers the label of "Biosphere Reserve" and helped the project of El Hierro to be achieve. The MAB action was reputedly in favour of sustainable actions at the local scale.

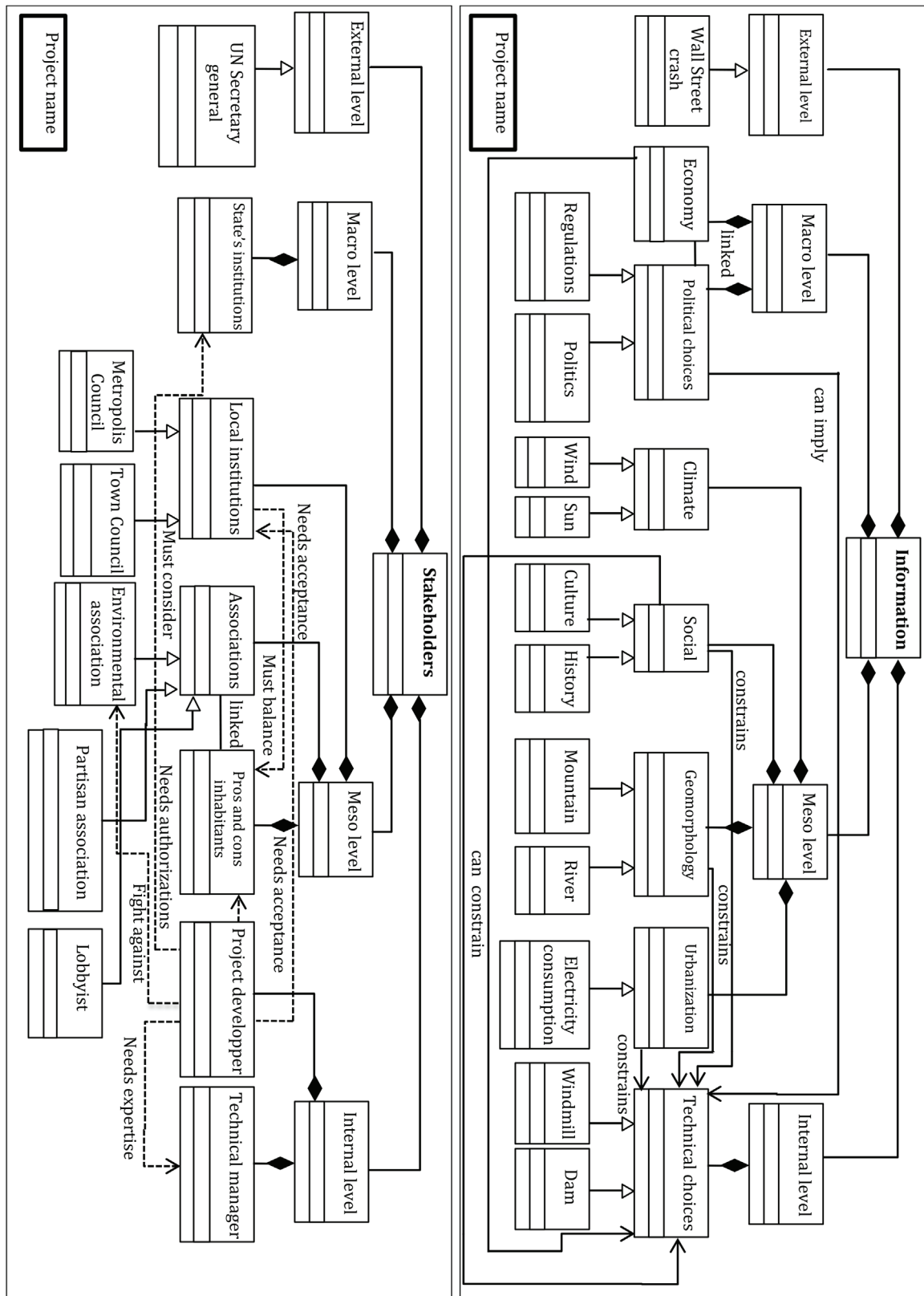

Fig. 4. Class diagram of issues agents and stakeholders agents.

- Loyola de Palacio, the Spanish Agriculture Minister in 1996 that then was nominated European Commissioner for Energy and Transport, and the first women Vice-President of the European

Commission from 1999 to 2004. Loyola de Palacio defended the project of El Hierro in all the international audiences.



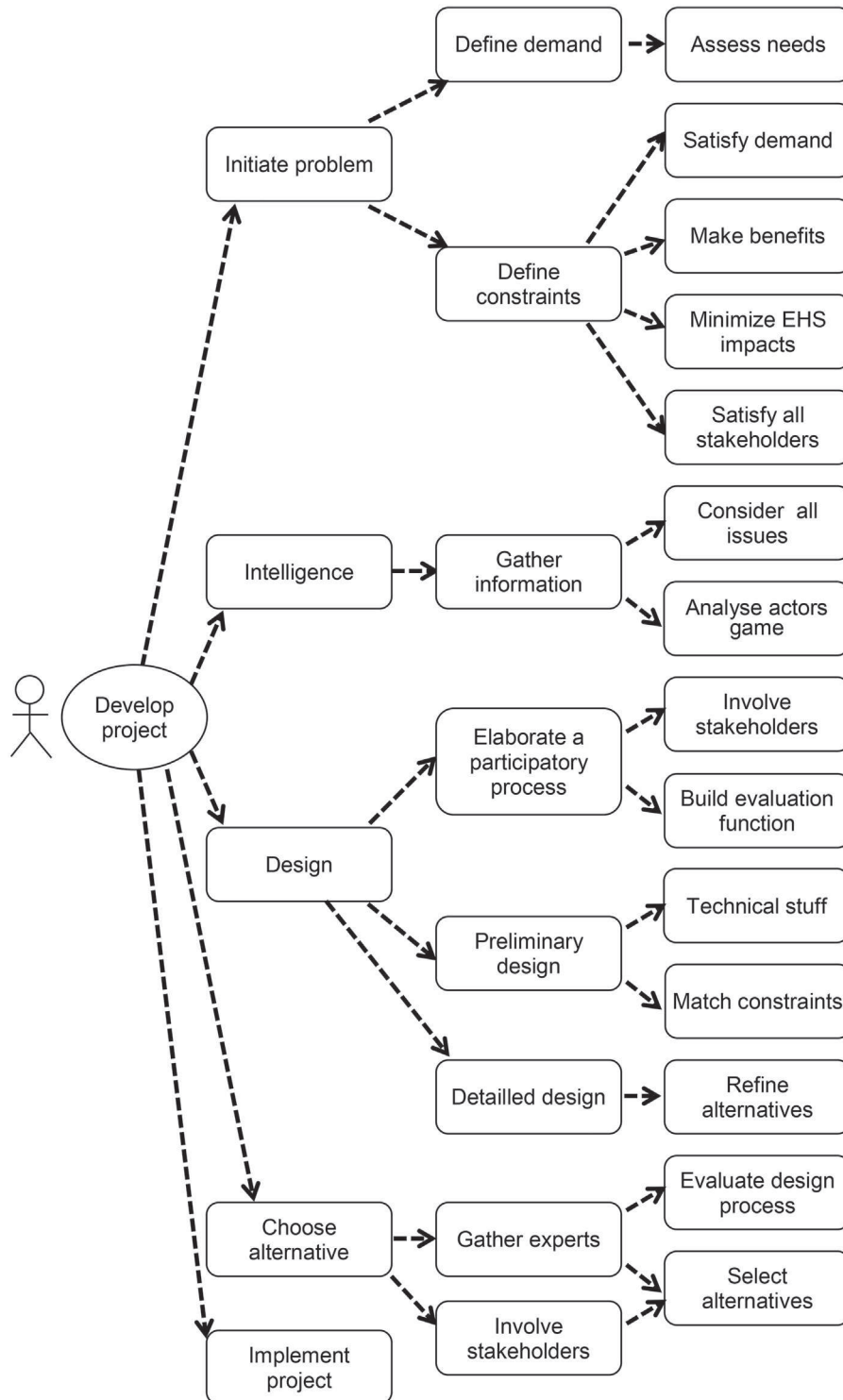

Fig. 5. Project developer use case diagram.

### 5.1.3. Static description – structural view

The Fig. 8 class diagram displays the objects that describe the El Hierro Project and their relations. The objects in grey are more specific while the dark and bold objects are more generic. Additional link information is listed in Table 4.

For the Information sphere agents, most of the links concern technical choices (L4 to L9) and set constraints on the project, coming from different kinds of levels – macro, meso in this case. Links L6 and L7 between climate, geomorphology and technical choices are

particular, firstly because they are not under human control, secondly because they both induce and constrain technical choices. Typically, in a windy region, it is better to install windmill, but the wind speed and direction profile during the year sets constraints on the apparatus. Similarly rivers and mountains create an opportunity to build a dam but also add some technical constraints to take into account river flows and physical characteristics.



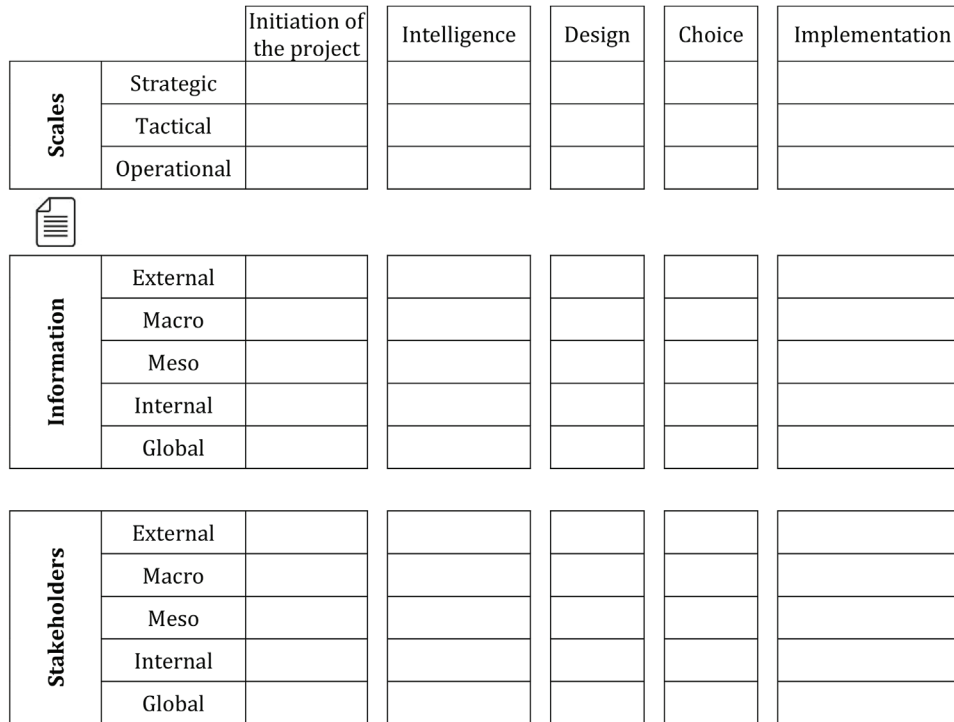

Fig. 6. Template for activity diagram.

**Table 4**  
List and explanation of links and relations of object diagrams of the El Hierro case study.

Links	Issues	Relations	Stakeholders
L1 reduce	Subsidies lowered the cost assumed by Gorona Del Viento	Association relation 1 (AS1)	I. Sánchez wears different hats
L2 trigger	Spanish army incursion triggered the transitions	AS2	I. Sánchez and T. Padrón worked together for ecological transition
L3 in complete opposition	Inhabitants' independency culture played against the Spanish army incursion	AS3	MAB service supported the El Hierro Council project to become Biosphere Reserve
L4 can justify	To reduce cost one would prefer a technical choice from another one	AS4	I. Sánchez and Don Zósimo worked together for the ecological transition
L5 can justify	Policies and regulations can induce technical choices	AS5	Don Zósimo and T. Padrón worked together for the ecological transition
L6 justify and constrain	Climate conditioned technical choices.	AS6	T. Padrón supported Gorona del Viento as the Council of El Hierro controlled 60% of the company's capital
L7 justify and constrain	Geomorphology offers opportunities and sets constraints.	AS7	Gonzalo Piernavieja Izquierdo gave technical support to Gorona del Viento
L8 justify	The need to secure fresh water on the island justified the choice of water storage	AS8	Loyola de Palacio gave a strong support for the energy transition
L9 constrain	Technical choices must meet the electricity demand	AS9	Local population support the wind farm project
L10 is the cause of	El Hierro decided to become self-sufficient in energy	Distrust relation 1 (DS1)	As operators of the fuel plant ENDESA feared losing market share

For the Stakeholders sphere agents, there exists an important network of association links between stakeholders through all levels:

- Isidóro Sánchez wears many different hats that make his contribution for the ecological transition active at all levels, but the internal one: as director of the National Parks of The Canaries, he published books to popularise the project El Hierro, and was the child of Don Zósimo (AS5), chief of forest rangers who actively fought for maintaining biodiversity on the island. Moreover, Isidóro Sánchez lobbied at the international level as a European deputy. Due to these different actions, the ecological transition received the support of UNESCO and especially by the UNESCO

MAB (Man and Biosphere) service in charge of the classification as a Biosphere Reserve (AS3).

- The creation of the company Gorona Del Viento was also a decisive action. It gathered around the energy transition several local actors like The Council of El Hierro (60% participation in capital) presided by Tomás Padrón and representing the local population, ENDESA UNELCO (30%) and the Technological Institute of the Canaries (10%) represented by Gonzalo Piernavieja Izquierdo (AS6, AS7 and AS9). The project offered to the local population an opportunity of development that would keep their identity, unlike the Spanish army base project, and as a unique sustainable project, it improved internationally their image. ENDESA UNELCO was initially reluctant to the energy transition project

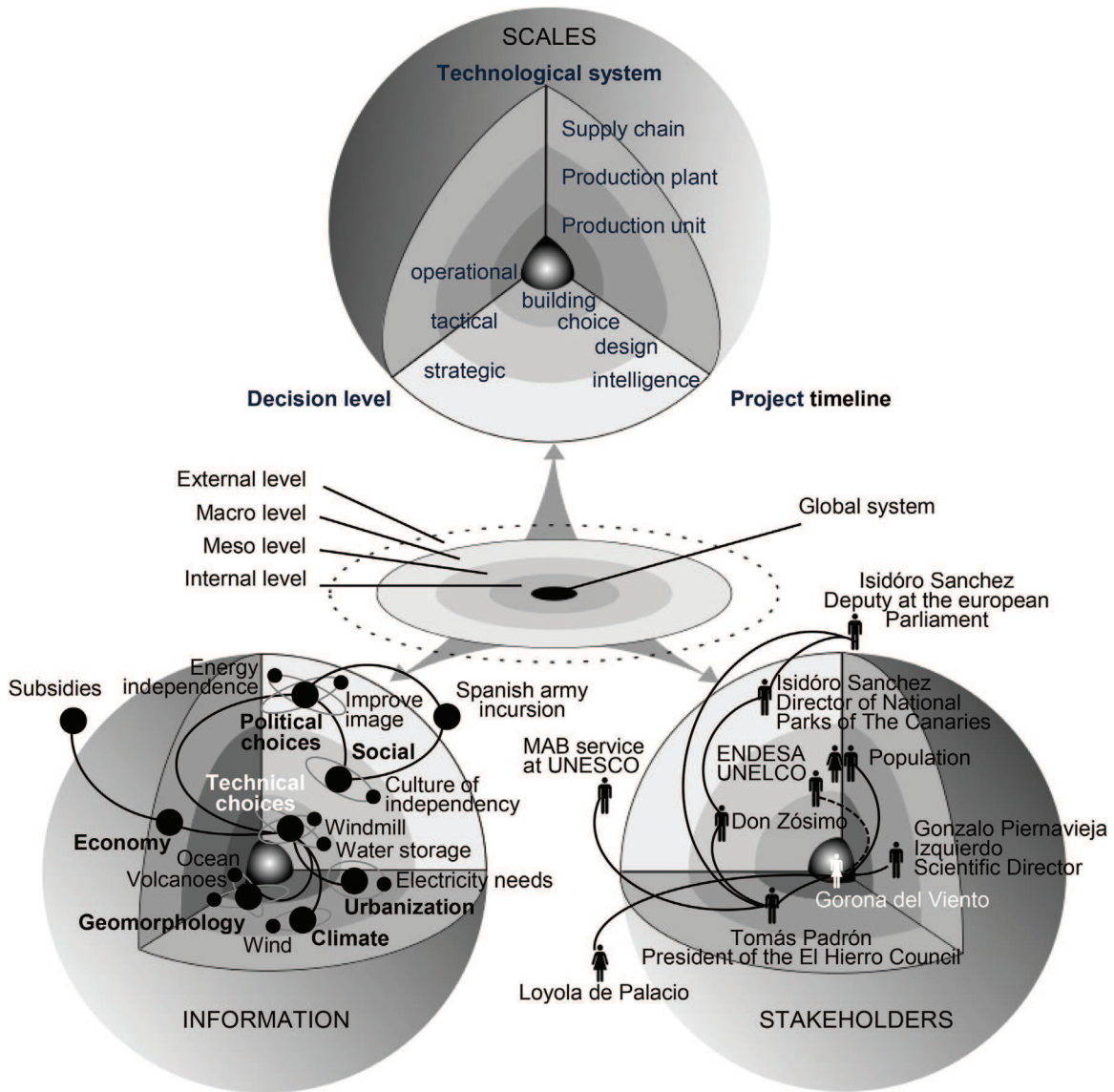

Fig. 7. Scheme of the El Hierro case study.

(DS1) since it conflicted its dominant position as the only distributor of electricity in El Hierro. But, its participation in Gorona del Viento's capital and prospect of being the future operator of the hydro-wind plant shifted its position into an active partner.

- The central position of Tomás Padrón (AS2, AS5 and AS6) should be highlighted because he is at the interface of the two transitions previously cited (ecology and energy). Because of his occupation of engineer at ENDESA UNELCO, he knew well the company's internal mechanisms; which was a crucial factor to facilitate negotiations over the control of Gorona del Viento.

The success of El Hierro transitions was mainly due to the fact that the local population and local actors were gathered for a common objective: remaining independent. Moreover, the support of Loyola De Palacio gave an international dimension to the energy transition of El Hierro (AS8) and was piloted at the meso- and macro- levels by tactical and strategic decisions made by Isidoro Sánchez, Tomás Padrón, and Don Zósimo, all natives from The Canaries and thus legitimate to act in the name of the local population.

#### 5.1.4. Dynamic description – functional view

The functional view of El Hierro Island's case study is not similar to the one shown in Fig. 5 but is a reduction of it. Indeed, we have not found any evidence of the goal of making benefits with the hydro-wind plant and we have notice that many European and spanish subsidies were provided. On the other hand, the satisfaction of stakeholders, esp. inhabitants, is crucial in that project. In a sense it is the expression of a political will from the island natives Isidoro Sánchez, Tomás Padrón, and Don Zósimo at the macro and meso levels.

#### 5.1.5. Dynamic description – behavioural view

Fig. 9 describes the dynamics of the hydro-wind plant project that crowns the energy transition on El Hierro's Island. We use UML2 to symbolize a long-term action (here "keep going on") interrupted by an event (here "Spanish army incursion").

During the initiation phase we recall steps of the ecological transition that led to the obtaining of the UNESCO Biosphere Reserve label in 2000. At the initiation of the project the El Hierro global system (mark 1 in Fig. 9) was disrupted by the incursion of the Spanish army on the Island (2). This event triggered a strategic

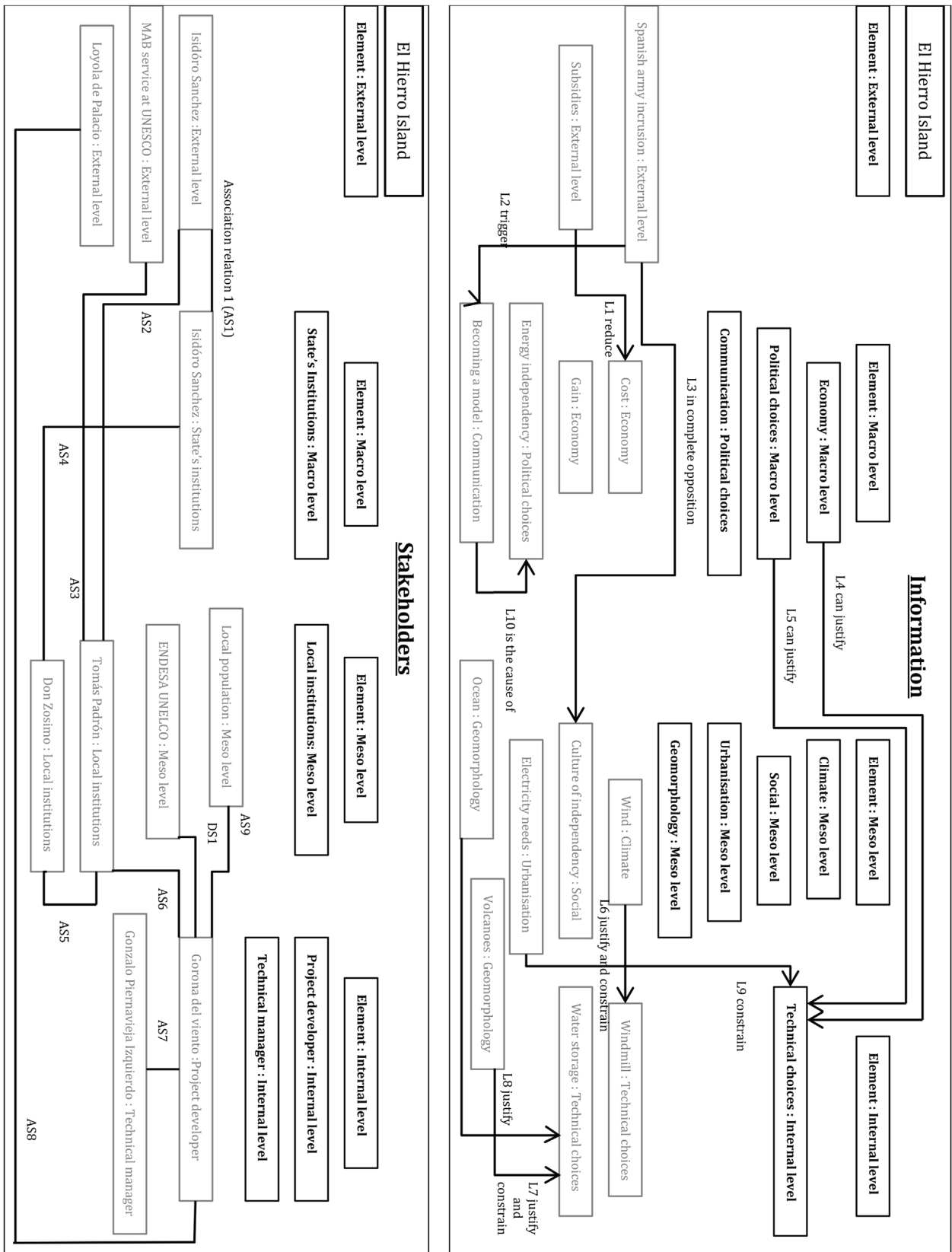

Fig. 8. Object diagram of Information and stakeholders spheres for the El Hierro case study.

decision taken by the global system: take control over their future (3) by becoming a model of sustainable development that would change their image internationally and attract new tourists (4). This

strategic decision guided the El Hierro global system all along the development process through an ecological and an energy transition.

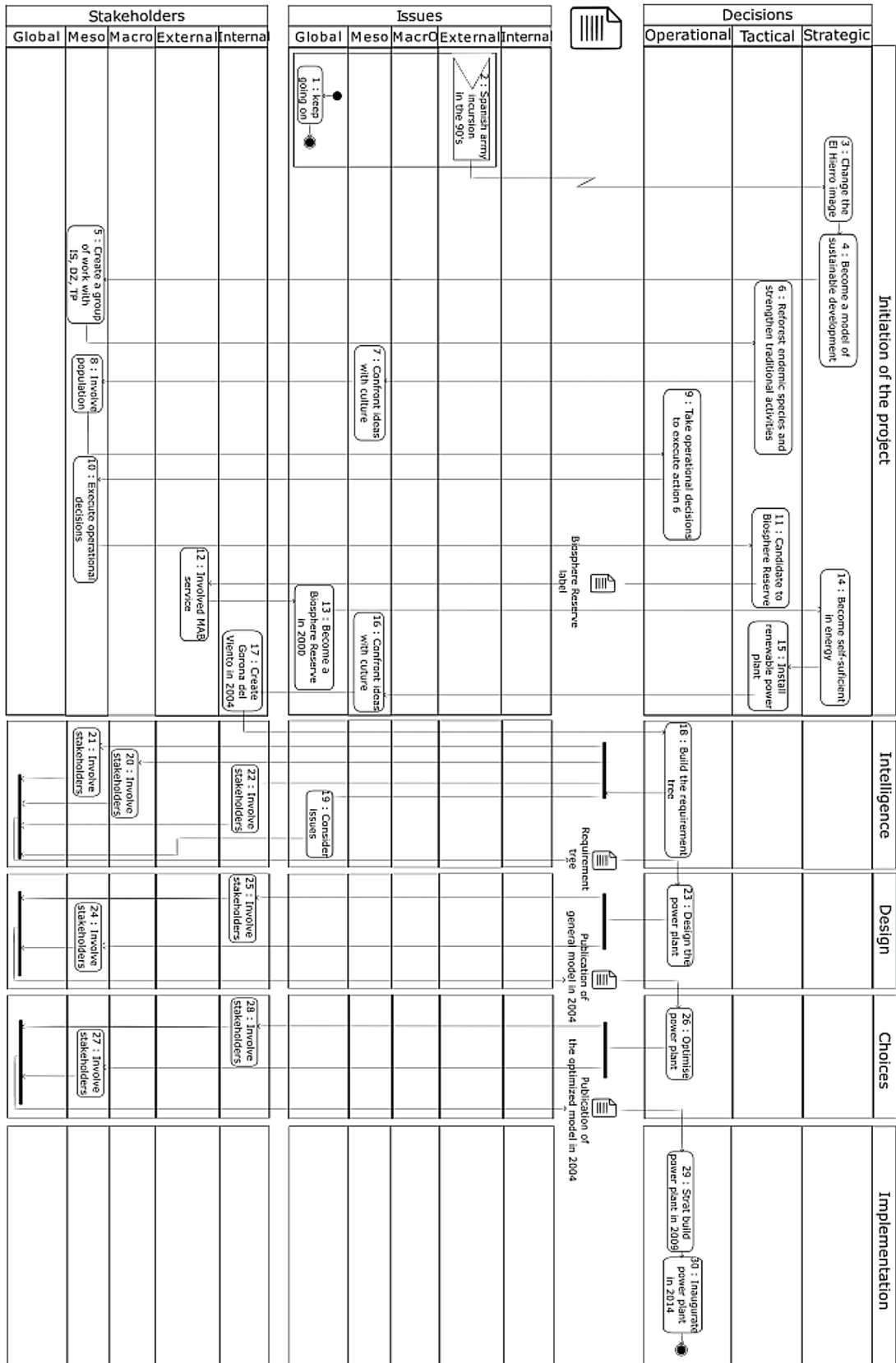

Fig. 9. Activity diagram of El Hierro Island case study.

Regarding stakeholders, by working together and with the support of the inhabitants, Isidoro Sánchez (IS), Don Zósimo (DZ) and

Tomás Padrón (TP) gave the necessary incentive to carry on the process (5). Then, tactical decisions were taken:

- To reforest endemic species and strengthening traditional activities (6). It received local support of people eager to perpetuate their culture and identity (7). Population was involved in the process (8) because they take operational decisions (9) since they are active in carrying on decision (6) and consequently, execute it (10).
- To become candidate to the UNESCO Biosphere reserve label (11), delivered by the MAB service (12). As explained above, MAB warmly encouraged the application and the label was awarded in 2000 (13).
- To become self-sufficient in energy (14) by installing a renewable power plant (15). Again, this action fits well with the local culture (16) making it easier to accept. Then, the process goes further and Gorona del Viento was created in 2004 (17). An actor game involving stakeholders of macro (20), meso (21) and internal level (22) started to build the requirement tree (18) and a new actor game designed the power plant (23). Climate and geomorphology coupled with drought issues favoured a hydro-wind plant, whose implementation model was published in 2004 (Bueno and Carta, 2004). Here, the choice phase came after with the optimisation of the power plant (26) (Bueno and Carta, 2008). In the subsequent design (24 and 25) and choice phases (27 and 28), two actor games involve stakeholders at meso and internal level. The building works could finally start in 2009 (29) and the process of development comes to an end after the inauguration of the power plant in 2014 (30).

This case study has shown how the framework presented in this study can describe the project, its elements and their relations, esp. regarding stakeholders that were decisive in the success.

## 5.2. Case study of Sivens dam project in Tarn in France South-Western

### 5.2.1. Overview of Sivens' case study

In this part, we present another case study: the project of Sivens dam in France South-Western in the department of Tarn which reached a tragic climax with the death of an opponent in October 2014.

In the Tarn and Tarn-et-Garonne department areas, intensive agriculture, esp. corn, requires irrigations to levels that threaten the current water resource available and water levels in the rivers. A possible solution was imagined in the late 60's: storing water in two dams, one of 0.9 Mm<sup>3</sup> in Thérondel (in operation since 2010) and another in Sivens to be built on the Tescou river. The geomorphology there is that of a hilly country and, with frequent hot and dry summers, the Tescou river level lies often below its critical level during summer. The Sivens dam project consisted in building a dam of 1.5 Mm<sup>3</sup> of water on the Tescou River flooding 41 ha, mainly for crop irrigation of an est. area of 309 ha directly for the benefit of initially 81 farmers (later revaluated at 40 people), and restoring water levels, in response to a chronic water shortage, especially in summer, that nowadays impact irrigated agriculture.

The project was imagined as far as 1969. In the 90's and early 21st century, corn crops were on the rise and required a lot of irrigation. On December 8th, 2003, the Water Agency of Adour-Garonne (AEAG) approved the so-called PGE plan for restoring the water level, which induced the building of a dam. The call for project issued by the Tarn department council ended up on August 4th, 2008 when the CACG – the land settlement company for the area of Coteaux de Gascogne was selected to develop the project, which costs was estimated at 8.4 M€. Newspaper reporters noticed that more than 70% of CACG capital is owned by state-backed communities, incl. Tarn dept council and the CACG board is made of several elected representatives of the Tarn dept. council. The same people were then involved in asking for the preliminary studies (part of

CACG activity), in agreeing the need for the dam (at Tarn council meeting), in voting its financing, and in staying in the board of the CACG that would develop the project.

Several technical studies were carried out starting in 2009. To compensate the flooding of 12 ha of a wetland area with protected species (so-called the Testet wetland), the CACG proposed in 2010 to restore 19.5 ha of wetland elsewhere. An opponent pro-environmental association was created in 2011, "Collectif Testet", aiming at protecting the Testet wetland threatened by the Sivens dam project, which they found inappropriate, both environmentally and financially. Moreover, they argued that the dam would perpetuate intensive agriculture practices and received the support of green party supporters. In the meanwhile, state-backed offices at the meso level approved the project that was then declared as being of public interest in 2012. In 2012–2013, several expertise by state organisations evaluated the impacts on nature and aquatic media and they questioned the relevancy of the wetland compensating measures.

In October 2013 a permanent site occupation started by nationwide activists called "zadists", after the building permit was issued. ZAD means "Zone to be defended". On September 1st, 2014 the river bank clearing of trees and bushes began as well as series of expulsion of occupants. Riot squad were sent upon request from the local authorities. Two activists carried out 61 and 55 days of hunger strike. Occupants came back and violence became routine between both parties, ending up with the death of the activist Rémy Fraisse, in the night during the night of Oct. 25th, 2014, after receiving a concussion grenade. In the meanwhile, the government requested a report in sept. 2014 and received it on Oct. 27th, froze the project on October 31st, 2014 and gave it up on December 4th, 2015. In 2016 the state court cancelled the whole procedure but a smaller project with two options is still under discussion with all stakeholders.

Unlike El Hierro's case study, the Sivens dam project illustrates a very limited interaction between all stakeholders across all the project layers and a willingness at the meso level of the Tarn Council to develop at any cost a project that would concern a small number of farmers to irrigate crops over 309 ha, only.

### 5.2.2. Static description – architectural view

The global system studied is the development of the dam project in the Sivens area. Based on Fig. 3, Fig. 10 describes the agents in the Information and Stakeholders spheres.

Only the stakeholders are now described.

- At the internal level there are:
  - The CACG – distributor of water to agriculture customers for the area of Coteaux de Gascogne – in the role of project developer.
- The technical manager is someone that works in the CACG so we consider that CACG represent both the project developer and the technical manager.
- At the meso level:
  - The Tarn Department Council who issued the call for project and chose CACG as developer.
- A Farmer association which asks to develop irrigation.
- The "Collectif Testet" is an association that is opposed of the project. Their slogan is "no dam. Towards an agriculture limiting water usage"
- Zadist – it is a French term referring to occupant of the site when the works started; ZAD meaning "Zone à défendre".
- The AEAG is the water agency of Adour Garonne basin which in charge to verify conformity of the project regarding the laws. It will also finance 50% of the total cost.
- At the macro level:
  - The administrative court is the State actor that is in charge of the arbitration of the conflict



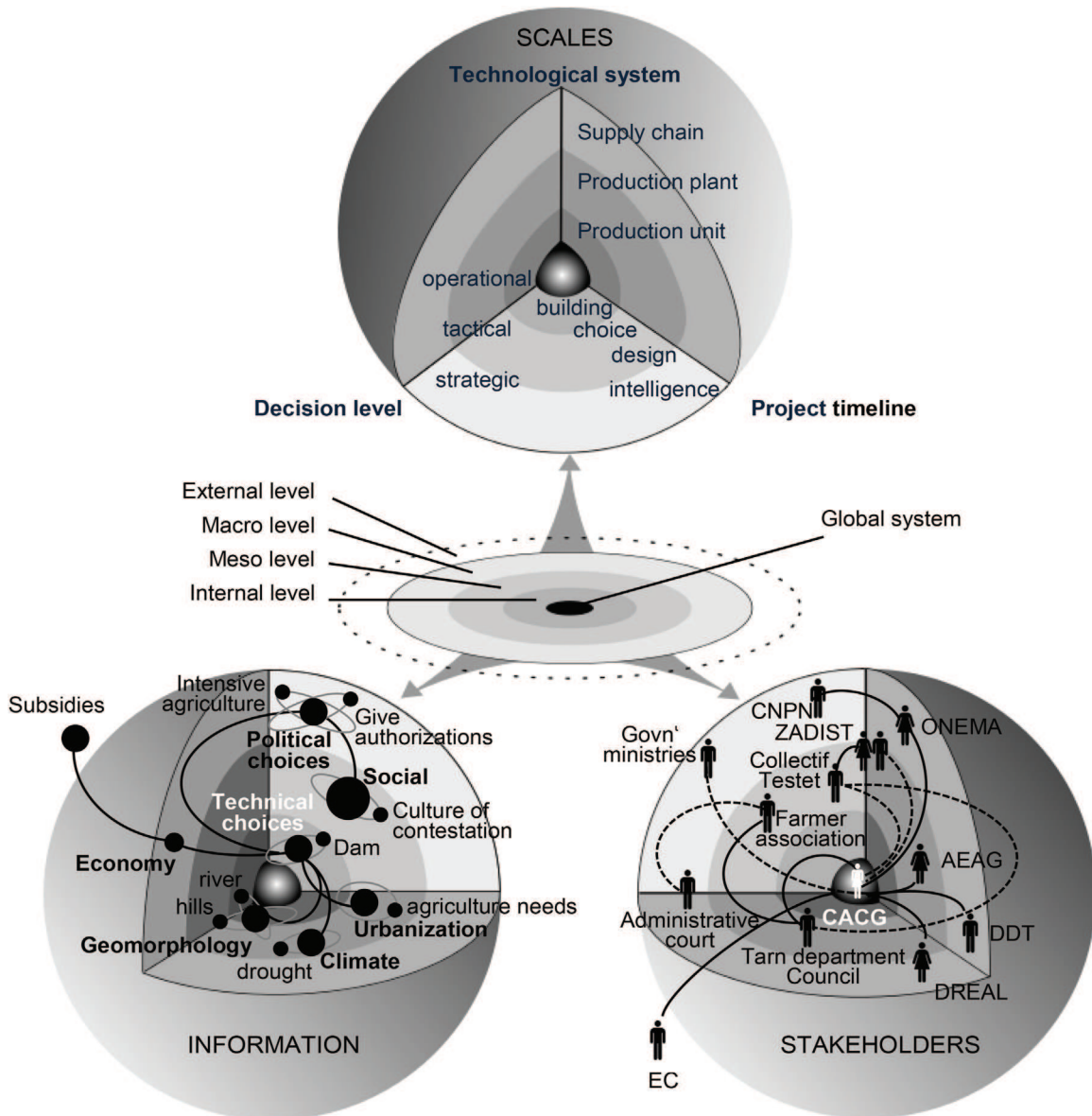

Fig. 10. Sivens dam project scheme.

- The Ministries refer to the government institutions at the state level involved in the project. In reality they were not that much involved because they decided to not interfere at the beginning.
- CNPN and ONEMA are French state organisations that expertise projects, on impact on protected area and animal species and on impact on aquatic resources respectively.
- DREAL and DDT are French state institutions that deal with land settlements projects and provide a technical evaluation, which must be positive for getting the building permit.

### 5.2.3. Static description – structural view

For concision we do not develop this part. The links between elements are illustrated in Fig. 5 and will be made explicit in the behavioural description.

### 5.2.4. Dynamic description – functional view

The functional view of Sivens's case study can be described with Fig. 5 diagram with an important difference that stakeholders' implication in the process phases by the project developer is limited to a few actors that have a direct interest in the project: farm-

ers associations, Tarn council, AEAG. Regarding, financial benefits, farmers would pay for water irrigation.

### 5.2.5. Dynamic description – behavioural view

Fig. 11 describes the dynamics of the Sivens dam project from 2002 to 2015. Initially, drought prevented farmer to run their business in good condition (1). Tarn council institution wanting to maintain agriculture backed the farmer's request and took the decision at the strategic level to build a dam to help irrigation and restore river water level (2). At the tactical level, the dam would be installed in the area of Sivens on the Tescou River (3). Some people noticed that heavily irrigated crops were then in the decline over the area early in the 2000's (4). At the operational level, the strategy would be carried out under a PGE (plan to maintain water levels in rivers) ordered by Tarn Department Council to CACG (5). The Tarn department council and AEAG evaluated favourably the project (6). So a call for proposal to find a project developer was issued (7) and the CACG won the project (8). The intelligence phase is almost non-existent. Hence it is not detailed in Fig. 11. Little critical re-evaluation of needs and participation of local stakeholders

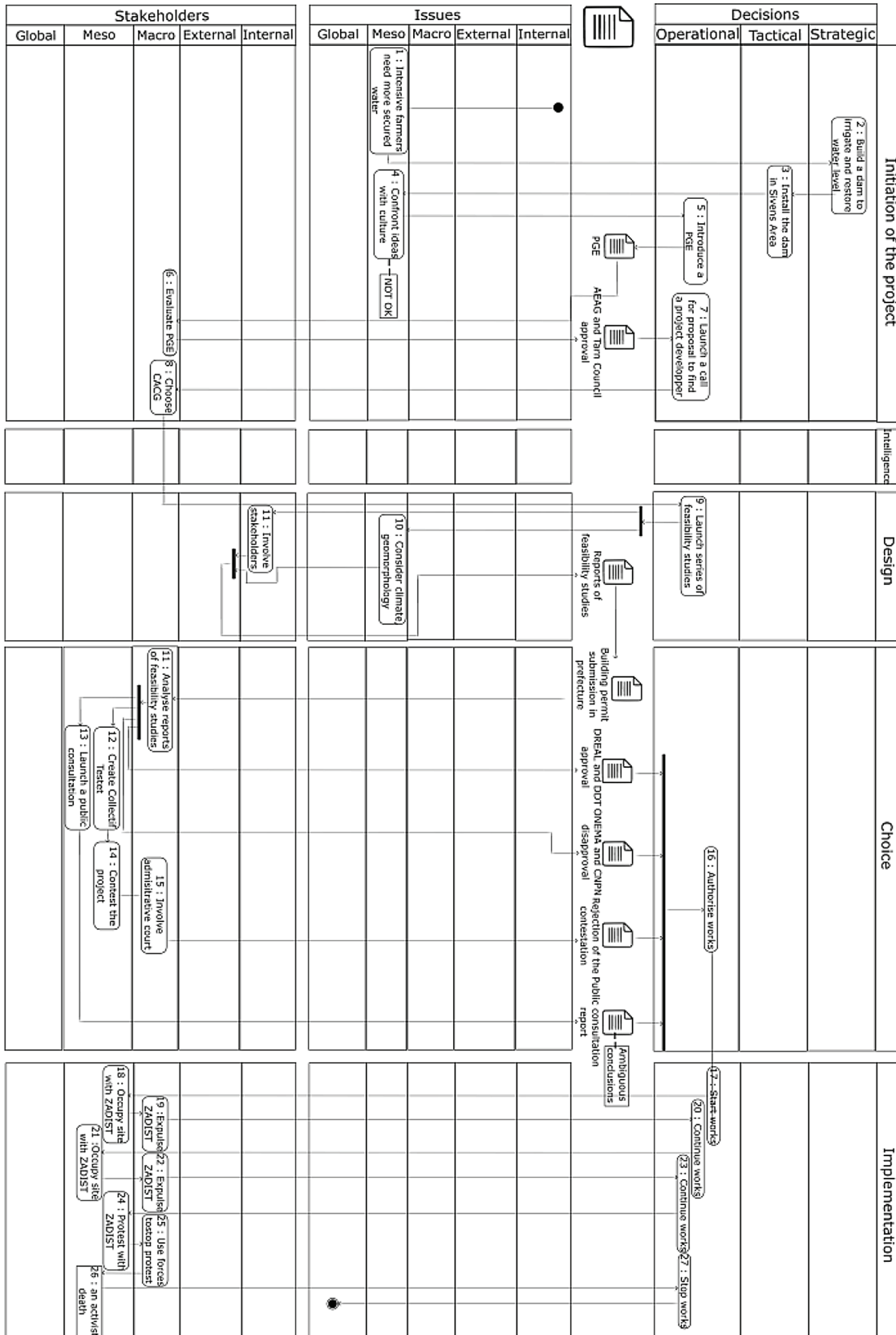

Fig. 11. Activity diagram of the Sivens' Dam case study.

was conducted. Then a series of feasibility studies (9) analysing the climate, geomorphology and urbanisation constraints (10) were carried out exclusively from the point of view of the developer

CACG (11) and presented to the Tarn council at the meso level. That institution approved unsurprisingly the project for which it had earlier commanded a PGE. It then submitted a building permit,

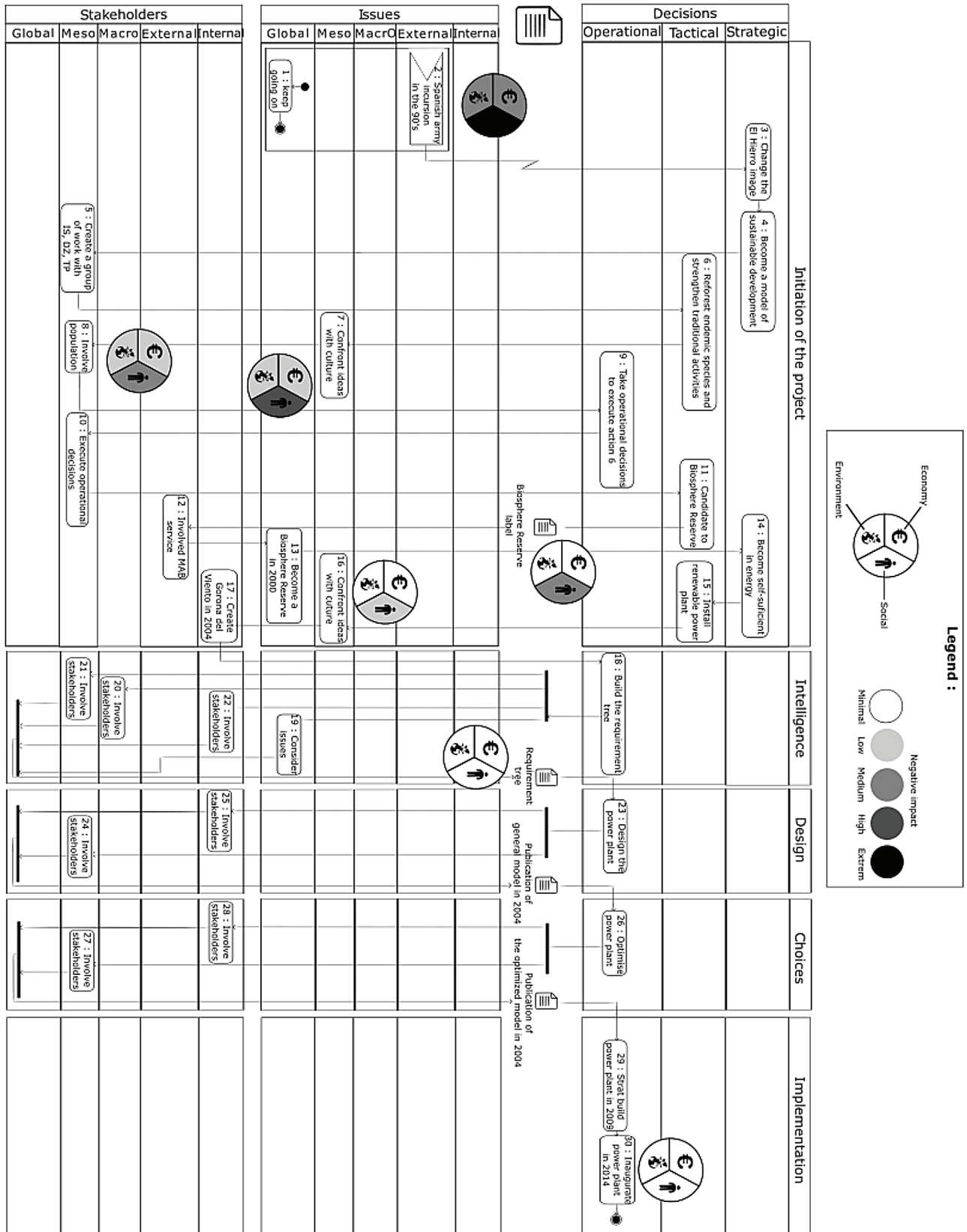

Fig. 12. El Hierro case study impact assessment.

which triggers evaluation from state institutions DREAL and DDT in charge of land settlement project evaluation. At the same time an environmental association Collectif Testet was created (12). DREAL

and DDT gave a positive technical evaluation of the building permit. In the meanwhile, the people opinion was asked formally in a public inquiry which duration is 5 weeks around sept. 2012. But local con-





test grew and was rapidly amplified nationally: Sivens' dam became a ZAD, which attracted hundreds of contesters from all over France. They contested the project by seeking justice (15). Nevertheless, the administrative court rejected the contestations including questions raised in the public inquiry. Hence, state institutions authorized project building to start (16). While the work started with excavators, wood cutters, etc. . . (17), ZADISTS decided to occupy the site to prevent work progress (18, 21). They faced several expulsions by the police (19, 22) and the construction works continue (20, 23). Tension built up on the site as both parties became more and more obstinate. ZADISTS demonstrations (24) were fought violently by specialized riot squads (25). In the fight, the police killed an activist with a concussion grenade (26). This event shattered all. It stopped the works (27) and finally the project was given up.

## 6. Discussion

### 6.1. Comparison of the two case studies

The two case studies presented in this paper ended up with different outcomes: the El Hierro project is an on-going success while the Sivens dam project was a complete failure. We now compare both and draw hypotheses on what are the ingredients of a sustainable development.

Regarding the architecture and structure of the two case studies:

- The framework describes reasonably well both case studies. It echoes a key idea of our contribution that information sphere agents have always the same architecture and often the same structure. It is only the final instantiations of the classes that differ from one project to the other.
- On the other hand, agents in the Stakeholders spheres seem to be always case specific, both in number, in type and in relations. We notice that in El Hierro's project, institutional stakeholders in charge of the development project are also strongly supporting the survival of the local culture whereas in Sivens' dam project the same actors are out of phase with the local culture and share another vision of development.

Regarding the functional view, it is obvious that the intentions of the project developer must be embedded in a holistic approach spanning all the agents of the information sphere. This is particularly important in the initiation step: in El Hierro's the project developer better defined needs and constraints than in the Sivens dam project. Furthermore, backed by political will at all levels, El Hierro's project developer insisted on satisfying all stakeholders and their participation during all phases. For Sivens dam, the political backing was only that of the Tarn department council at the meso level and it appears that they were collusive with the developer in the project initiation and selection. That exemplifies that one must take into account social acceptance of the project at all stages of the development process. Social acceptance is difficult to assess, as it is a complex mix of culture, history and compliance of the development process with the identity and the values of population.

By those examples, we want to highlight the importance to consider elements providing a holistic overview as in our framework to assess the sustainability of land settlement projects within their implementation context.

The behavioural view is a synthetic diagram built upon the three other views and it tells about the dynamics of the project through the project phases.

- A first major difference between both projects is that in El Hierro stakeholders are much more involved in the project and much

earlier (compare [Figs. 9 and 11](#)): typically during the initiation phase, the development process's pathway goes 5 times in the stakeholders sphere in El Hierro's case and only once in the Sivens case. Besides there is no holistic actors game in the implementation phase for El Hierro case study, since everything was settled earlier.

We think that the promotion of an active participation of all stakeholders at all stages of development process and especially in the early stage, is mandatory to perform a project that would qualify as sustainable especially over the long-term exploitation phase.

- Another issue is the positive resonance between the project goals and the local culture, both in terms of strategic and tactical decisions for El Hierro. In Sivens' case the resonance is out of phase early in the project. Compensation measures for restoring wetlands are proposed in a second time but they do not quiet opposition that becomes stronger and stronger. So, to be sustainable a project must preserve the patrimony of local stakeholders, both in terms of culture and assets.

According to the recommendations above, a revisited engineering methodology is necessary to perform sustainable project. That contrasts with the usual process for designing technical items of projects and also the hierarchical vision that dominates engineering activities: the decision tree is usually carried out downward from strategic levels to operational levels as top decisions impose themselves to lower level decisions. For an active stakeholders' participation that would improve social acceptance of projects, we recommend to conduct a back and forth process rather than a hierarchical one. This is much more difficult to put in practice but a software implementation of our framework would probably help and is under progress.

### 6.2. Sustainability assessment

The behavioural view UML diagrams are full of information and the complexity they represent is not easy to grasp, especially in terms of sustainability. Hence we add in this section a descriptive and qualitative layer to assess the sustainability of development processes.

[Gagnon et al., 2012](#) reviewed non sustainable and sustainable design process (SDP) in the literature and propose to classify activities of SDP as follow: planning and problem definition, conceptual design, preliminary design, and detail design. Then, the authors split those four activities in 21 tasks. Hereafter, [Table A1](#) in Appendix gives the 21 tasks, the one in bold are the 11 considered as critical in a SDP by [Gagnon et al. \(2012\)](#).

Finally, they proposed a methodology to assess sustainability over six dimensions that refer to the Design process itself, the sustainability issues covered, the relevance of the indicators, the accuracy of the analysis tools, the performances of alternatives, and the decision making process, by giving a shade of sustainability (from A= minimally to D= entirely) according to the number of crucial tasks fulfilled.

Since we were not part of the development processes of El Hierro's hydro wind plant and Sivens' Dam project, some information are missing, especially about criteria used in development processes so we can only address the Design process dimension.

Let's consider the activity diagram of El Hierro's project ([Fig. 9](#)). According to the tasks given in [Gagnon et al. \(2012\)](#) El Hierro's project fulfils:

- Tasks 1, 2, 4, and 6: A multidisciplinary team has been formed in activity 5, 8, 20, 21, 22. Sustainability principles has been defined because they wanted to become a model of sustainability development for the world and sustainability issues have been identify



since the project has been confronted to culture, environment (Biosphere Reserve), and obviously economy. Stakeholders have been widely associated to the project (see activities 20, 21, 22).

- Tasks 7, 9, and 12, 14: a complete requirement tree has been established by the diversity of stakeholders and decisions have been made by stakeholders with multiple point of view.
- Tasks 15, 16: a scientific publication of the technico-economic analysis has been published (Bueno and Carta, 2004)
- Tasks 18, 19, 20, and 21: a scientific publication exposed the optimisation of the plant has been published (Bueno and Carta, 2004).

So according to Gagnon et al., 2012 methodology, El Hierro's project achieves 14 tasks, that correspond to a "B shade" of sustainability which qualifies it as partially sustainable.

Now if we look at Sivens Dam project (Fig. 11), we can say that its design process fulfils much less tasks:

- Task 6 is covered only partially, as stakeholders' involvement was clearly not complete nor systematic enough
- Task 12 and 15 are also covered partially as only a technical criterion has been defined

So according to Gagnon's methodology where the worst "A-shade" requires 10 tasks to be addressed, Sivens Dam project design process is just not sustainable at all.

If we relate Gagnon's assessment proposal to our framework, we can notice that:

- Task 1 is relative to our stakeholders sphere as well as task 6.
- Tasks 2-5 are relative to the information sphere. The sustainability conceptual framework is our framework as a whole. Tasks 4 and 5 are completely fulfilled thanks to respectively architecture view and structural view of the information sphere
- Tasks 7-21 are carried out properly thanks to the previous tasks 1-6. Most of those tasks concern sustainability assessment with multi-criteria analysis. They can be grasped in the behavioural view.

Regarding the Gagnon's five shaded dimensions that we could not evaluate since we do not have enough information, we finally propose an alternative intuitive sustainability assessment.

We consider an indicator as a pie chart with three sectors based on the three pillars of sustainable development, Society, Environment and Economy. They are placed on top of the behavioural diagram as shown in Figs. 12 and 13. Coloring are used to describe the perceptible negative impact in one sector. The goal for the project developer is to reach the all white/0% impact mark for the three sectors, hinting that the development process was sustainable.

For the El Hierro system, the Spanish army project of settling a radar military base skyrockets the society impact to 100% as it threatens the local culture at all levels: inhabitants, local institutions and elected officials at the national parliament. As it might likely degrade the island image for future tourists, it raises the impact on environment and on economics as well (Fig. 12).

The strong involvement of stakeholders at all levels and decisions to become a biosphere reserve and build a renewable power plant with the claim of being 100% self-sufficient, a nice image to promote tourism; and the finding of fundings lower the environmental and economic impacts respectively. Adhesion of the population and stakeholders drops the society impact as well. Impacts are estimated to reach 0% at the beginning of the design phase, after the intelligence phase.

Regarding the Sivens' dam project, the impact assessment is quite different. At the beginning, intensive agriculture farmers are

not satisfied of water shortage during summer, which sets the society impact at 50% and the economic impact as well since they can't run their irrigated crops business in good conditions. Environmental impact is at 25% because intensive agriculture impacts the environment. The decision to build a dam improves the society impact of the farmers (impacts on other stakeholder is ignored at that time) (society impact at 25%), but affects the environment (environmental impact raise at 50%). But when local population and pro-environment associations get involved, the society impact raises at 50%. The PGE aiming at maintaining the river water level reduces environmental impact at 25%.

Then through all phases, since the process is not participatory enough and does not fit the society will, the society impact keeps rising to 75% at the end of the choice phase, and finally up to 100% when the death of an activist occurs.

At the end of the process, the environmental impact also raises because clearing and deforestation were started, fought by activist occupation on site, and economic impact raised since money was spent for nothing at the end. Furthermore, the CACG received a state compensation of approx. 50% of the total cost.

In comparison with Gagnon's shades, our intuitive pie chart is noticeably more optimistic for El Hierro's Island project, and reaches the same conclusion for Sivens' dam project being not sustainable. Gagnon's shade should then be considered preferably to alert about deviation from a sustainable design process.

## 7. Conclusion and perspectives

The aim of this paper was to present a framework enable to describe and assess the development process of land settlement project thanks to four views recommended by the ISO 19440 standard: architectural, structural, functional and behavioural.

Even if the first three views are fundamental to set the scenery of the project and mandatory to describe the development process, the most interesting view is the behavioural one as it makes visible the development process. Second comes the compliance of the project objectives with those listed in the functional view we proposed. For El Hierro's project, financial benefit was accessory in front of the well being and independence of the local inhabitants. For Sivens' project, financial benefit was loose and a very limited number of farmers would have been satisfied.

By using our framework to describe two case studies, El Hierro Hydro-Wind project and Sivens dam project, we have shown how to use it to read through the complexity of the development process of land settlement. Thanks to a comparison between the two case studies we have also highlight the capacity of our framework in revealing what can be the ingredients of a successful development.

This work contributed to fill the lack of holistic conceptual framework highlighted in Buchholz et al. (2007). It is only a first step toward its implementation as the "planning and evaluation tool" wished for by Buchholz et al. (2007). As we stated in the introduction, the implementation in progress will be carried out by a workflow supported by an inference motor of an ontology derived from Benaben's core ontology (Lauras et al., 2015; Bénaben et al., 2016). His metamodel exclusively considers cooperating stakeholders. Based on our analysis of the case studies, we must make additions for handling non-cooperative situations. Another perspective lies in the sustainability assessment. We have noticed that the simplified pie chart covering the three pillars of sustainability is too simple and we find that Gagnon's elaborated shades over six aspects would be more appropriate.

## Appendix A. Assessment of the sustainability of a design process (from Gagnon et al., 2012).

**Table A1**

21 tasks of sustainability from Gagnon et al. (2012).

Design Phase	Tasks proposed
I-Planning and problem definition	1 – Form a multidisciplinary design team 2 – Define sustainability principle 3 – Define a sustainability conceptual framework 4 – Identify sustainability issues associated with the defined problem 5 – Identify the relationship between the project and the elements in the conceptual framework 6 – Analyse stakeholders and plan stakeholder involvement
II-Conceptual analysis	7 – Define sustainability criteria in line with the sustainability issues previously identified, analysis in parallel with technical functions 8 – Confirm the comprehensiveness of the sustainability criteria with the conceptual framework 9 – Develop a vision for the future in which functions are fulfilled respecting the sustainability principles 10 – Generate at least one alternative concept radically different from conventional ones using sustainability creativity tools 11 – Define broad scenarios in which the alternative concepts are likely to evolve 12 – Define sustainability indicators derived from the issues or criteria, in parallel with technical specifications derived from functions 13 – Identify the analysis tools with which data will be generated for each of indicators 14 – Chose a multi-criteria decision aid method
III-Preliminary design	15 – Assess the performance of alternative concepts according to the sustainability criteria or design indicators, including one "benchmark alternative" representative of current practice 16 – Validate the multi-criteria decision aid method chosen and use it to recommend a preferred concept 17 – Validate the performance of the alternative concepts under the scenarios identified
IV-Detailed design	18 – Refine the assessment of the preferred concept and optimise its performance along design sustainability criteria or indicators 19 – Maximize the adaptability of the preferred concept under scenarios identified 20 – Communicate recommendations for the manufacturing, construction, use and end of life phases 21 – Generate the set of sustainability indicators for monitoring

## References

- Ansoff, H., 1965. *Corporate Strategy an Analytic Approach to Business Policy for Growth and Expansion*. McGraw-Hill, New-York (Sustainable development plan, 2006. Retrieved from Cabildo del Hierro) <http://www.elhierro.es/files/Plan%20desarrollo%20sostenible/PDS.pdf>.
- Azapagic, A., Perdan, S., 2014. Sustainable chemical engineering: dealing with wicked sustainability problems. *AIChE J.* 60 (12), 3998–4007.
- Azapagic, A., Stamford, L., Youds, L., Barteczko-Hibbert, C., 2016. Towards sustainable production and consumption: a novel DECision-Support framework IntegRating economic, environmental and social sustainability (DESIREs). *Comput. Chem. Eng.*, <http://dx.doi.org/10.1016/j.compchemeng.2016.03.017>, in press.
- Bénaben, F., Luras, M., Trupitil, S., Salatgé, N., 2016. A metamodel for knowledge management in crisis management. *HICSS Proceedings 2016*, 126–135, <http://dx.doi.org/10.1109/HICSS.2016.24>.
- Baud, A., Couturier, S., 2015. Sociological study of the acceptance of demand response in office buildings. In: *Contemporary Societies Faced with Energy Transitions (2nd JISE)*, Tours, France.
- Boix, M., Montastruc, L., Azzaro-Pantel, C., Domenech, S., 2015. Optimization methods applied to the design of eco-industrial parks: a literature review. *J. Cleaner Prod.* 87 (1), 303–317.
- Buchholz, T., Volk, T., Luzadis, V., 2007. A participatory systems approach to modeling social, economic, and ecological components of bioenergy. *Energy Policy* 35 (12), 6084–6094.
- Buchholz, T., Rametsteiner, E., Volk, T., Luzadis, V., 2009a. Multi criteria analysis for bioenergy systems assessments. *Energy Policy* 37, 484–495.
- Buchholz, T., Luzadis, V., Volk, T., 2009b. Sustainability criteria for bioenergy systems: results from an expert survey. *J. Clean. Prod.* 17, S86–S98.
- Bueno, C., Carta, J., 2004. Technical-economic analysis of wind-powered pumped hydrostorage systems. Part I: model development. *Sol. Energy* 78, 382–395.
- Bueno, C., Carta, J., 2008. Technico-economic analysis of wind-powered pumped hydrostorage systems. Part II: model application to the island of El Hierro. *Sol. Energy* 78, 396–405.
- Cherni, J., Dynerb, I., Henaoc, F., Jaramillod, P., Smith, R., Olalde Font, R., 2007. Energy supply for sustainable rural livelihoods. A multi-criteria decision-support system. *Energy Policy* 35, 1493–1504.
- Dale, V.H., Efromyson, R.A., Kline, K.L., Langholtz, M.H., Leiby, P.N., Oladosu, G.A., Davis, M.R., Downing, M.E., Hilliard, M.R., 2013. Indicators for assessing socioeconomic sustainability of bioenergy systems: a short list of practical measures. *Ecol. Indic.* 26, 87–102.
- Dowling, A.W., Ruiz-Mercado, G., Zavala, V.M., 2016. A framework for multi-stakeholder decision-making and conflict resolution. *Comput. Chem. Eng.* 90, 136–150.
2014. El Hierro Project of Hydro-Wind Power Plant, Retrieved from ENDESA: <http://www.endesa.com/es/conoceendesa/lineasnegocio/principalesproyectos/Documents/Dossier-ElHierro.pdf>.
- Etienne, M., Du Toit, D., Pollard, S., 2008. ARDI: a co-construction method for participatory modelling in natural resources management. In: *IEMSS Congress, Barcelona, Spain*, 2–866–873.
- Gagnon, B., Leduc, R., Savard, L., 2012. From conventional to a sustainable engineering design process: different shades of sustainability. *J. Eng. Des.* 23, 1–23.
- Garcia, D.J., You, F., 2015. Supply chain design and optimization: challenges and opportunities. *Comput. Chem. Eng.* 81, 153–170.
- Geraili, A., Sharma, P., Romagnoli, J.A., 2014. A modeling framework for design of nonlinear renewable energy systems through integrated simulation modeling and metaheuristic optimization: applications to biorefineries. *Comput. Chem. Eng.* 61, 102–117.
- Gioda, A., 2014. El Hierro (Canaries): une île et le choix d'une transition énergétiques et écologique. *Vertigo – la revue électronique en sciences de l'environnement* 14, 3, <http://dx.doi.org/10.4000/vertigo.15595>.
- Godina, R., Rodriguez, E.M.S., Matias, J.C.O., Catalao, J.P.S., 2015. Sustainable energy system of el hierro island. In: *proc. of ICREPQ'15, La Corona, March 2015*, ISSN 2172-038 X.
- Heintz, J., Belaud, J.P., Gerbaud, V., 2014. Chemical enterprise model and decision-making framework for sustainable chemical product design. *Comput. Ind. Spec. Issue* 65 (3), 505–520.
- Heiskanen, E., Kasanen, P., Timonen, P., 2005. Consumer participation in sustainable technology development. *Int. J. Consum. Stud.* 29, 98–107.
- Huber, S., Horbaty, R., 2010. Social acceptance of wind energy. In: *International Energy Agency (IEA) – Wind Task 28 Technical Report – State of the Art-Report*. IEA, Switzerland, 91 p.
- Huber, S., Horbaty, R., 2013. Social acceptance of wind energy projects. In: *International Energy Agency (IEA) – Recommended Practice Report 14*. IEA, Switzerland, 39 p., [http://www.socialacceptance.ch/images/RP\\_14\\_Social-Acceptance\\_FINAL.pdf](http://www.socialacceptance.ch/images/RP_14_Social-Acceptance_FINAL.pdf) (Accessed June 2016).
- Hung, H., Kao, H., Juand, Y., 2008. An integrated information systems for product design planning. *Expert Syst. Appl.* 35, 338–349.
- IEEE, 2000. *Recommended Practice for Architectural Description of Software-Intensive Systems*, IEEE-std-1471-2000.
- ISO/DIS 19440.2, 2005. *Enterprise Integration—Constructs for Enterprise Modeling*. ISO, Geneva.
- Luras, M., Bénaben, F., Trupitil, S., Lamothe, J., Macé-Ramète, G., Montarnal, A., 2015. A meta-ontology for knowledge acquisition and exploitation of collaborative social systems. *BESC Conference Proceedings*, <http://dx.doi.org/10.1109/besc.2014.7059526>.
- Marquardt, W., Nagl, M., 2004. Workflow and information centered support of design processes—the IMPROVE perspective. *Comput. Chem. Eng.* 29, 65–82.
- Mendoza, G., Prabhu, R., 2005. Combining participatory modelling and multi-criteria analysis for community-based forest management. *For. Ecol. Manage.* 207, 145–156.
- Miret, C., Chazara, P., Montastruc, L., Negny, S., Domenech, S., 2016. Design of bioethanol green supply chain: comparison between first and second generation biomass concerning economic, environmental and social criteria. *Comput. Chem. Eng.* 85, 16–35.
- Perez, J.M., Ruiz, F., Piattini, M., 2008. MDE for BPM: a systematic review. In: *Filipe, J., Shishkov, B., Helfert, M. (Eds.), Software and Data Technologies, Communications in Computer and Information Science*. Springer, Berlin, Heidelberg, pp. 127–135.

- Phillips-Bertin, C., Champelovier, P., Poupon, L., 2015. *Assessing the acceptability of electric cars by the scenario methods*. In: *Contemporary Societies Faced with Energy Transitions (2nd JISE)*, Tours, France.
- Raven, R.P.J.M., Jolivet, E., Mourik, R.M., Feenstra, Y.C.F.J., 2009. *ESTEEM: Managing societal acceptance in new energy projects A toolbox method for project managers*. *Technol. Forecasting Soc. Change* 76, 963–977.
- Santibañez-Aguilar, J.E., Gonzalez-Campos, J.B., Ponce-Ortega, J.M., Serna-Gonzalez, M., El-Halwagi, M.M., 2014. *Optimal planning and site election for distributed multiproduct biorefineries involving economic, environmental and social objectives*. *J. Clean. Prod.* 65, 270–294.
- Scott, J.A., Ho, W., Dey, P.K., 2012. *A review of multi-criteria decision-making methods for bioenergy systems*. *Energy* 42 (1), 146–156.
- Sharma, P., Vlosky, R., Romagnoli, J.A., 2013. *Strategic value optimization and analysis of multi-product biomass refineries with multiple stakeholder considerations*. *Comput. Chem. Eng.* 50, 105–129.
- Simon, H., 1960. *The New Science of Management Decision, The Ford Distinguished Lectures*. Harper and Row, New York and Evanston.
- Vernadat, F.B., 2002. *Enterprise modeling and integration (EMI): current status and research perspectives*. *Ann. Rev. Control* 26, 15–25.
- Von Bertalanffy, L., 1968. *General System Theory*.
- You, F., Tao, L., Graziano, D.J., Snyder, S.W., 2012. *Optimal design of sustainable cellulosic biofuel supply chains: multiobjective optimization coupled with life cycle assessment and input-output analysis*. *AIChE J.* 58, 1157–1180.
- Yue, D., You, F., Snyder, S.W., 2014. *Biomass-to-bioenergy and biofuel supply chain optimization: overview, key issues and challenges*. *Comput. Chem. Eng.* 66, 36–56.
- Zaibi, M., Champenois, G., Belhadj, J., Roboam, X., Sareni, B., 2014. *Smart power management for an off-grid photovoltaic/wind/battery energy system*. In: *11th International Conference on Modeling and Simulation of Electric Machines, Converters and Systems (ELECTRIMACS'2014)*, Valencia, Spain.