



**HAL**  
open science

## Similar but different: investigating temporal constructions in sign language

Valentina Aristodemo, Charlotte Hauser

### ► To cite this version:

Valentina Aristodemo, Charlotte Hauser. Similar but different: investigating temporal constructions in sign language. *Glossa: a journal of general linguistics* (2021-..), 2021, 6 (1), 10.5334/gjgl.999 . hal-03509783

**HAL Id: hal-03509783**

**<https://hal.science/hal-03509783>**

Submitted on 22 Dec 2023

**HAL** is a multi-disciplinary open access archive for the deposit and dissemination of scientific research documents, whether they are published or not. The documents may come from teaching and research institutions in France or abroad, or from public or private research centers.

L'archive ouverte pluridisciplinaire **HAL**, est destinée au dépôt et à la diffusion de documents scientifiques de niveau recherche, publiés ou non, émanant des établissements d'enseignement et de recherche français ou étrangers, des laboratoires publics ou privés.



# Similar but different: investigating temporal constructions in sign language

**VALENTINA ARISTODEMO** 

**CHARLOTTE HAUSER** 

*\*Author affiliations can be found in the back matter of this article*

RESEARCH

]u[ubiquity press

## ABSTRACT

This paper presents a study of French Sign Language (LSF) temporal constructions. While we know from spoken language research that temporal constructions can be expressed through a variety of syntactic strategies such as subordination, juxtaposition, and coordination, finding their equivalent in sign languages is often a challenge due to the absence of overt complementizers and other function words such as coordinators. This study explores temporal constructions in LSF and frames them within a broad typological perspective. We show that LSF temporal clauses are very different from those of Italian Sign language (LIS) studied by Aristodemo (2017). Specifically, LSF temporal constructions are composed of two coordinated clauses and the temporal marker is integrated into the second conjunct. LIS temporal clauses, on the other hand, are composed of a main and a subordinated clause. This finding shows that the typological categories found in spoken language are also relevant for sign language studies.

## CORRESPONDING AUTHOR:

**Valentina Aristodemo**

LLF, Université de Paris, 8 rue  
Albert Einstein, 75013, Paris

[valentina.aristodemo@gmail.com](mailto:valentina.aristodemo@gmail.com)

---

## KEYWORDS:

Temporal constructions;  
French Sign Language; Italian  
Sign Language; Asymmetric  
coordination; Typology; Syntax

## TO CITE THIS ARTICLE:

Aristodemo, Valentina and  
Charlotte Hauser. 2021. Similar  
but different: investigating  
temporal constructions in  
sign language. *Glossa: a  
journal of general linguistics*  
6(1): 2. 1–19. DOI: <https://doi.org/10.5334/gjgl.999>

Temporal constructions are complex syntactic structures whereby an adverb expresses a temporal relation between the events described in two clauses. Syntactically, temporal constructions can be expressed by using several strategies (subordination, coordination, and juxtaposition) and languages vary typologically with respect to the strategy adopted.

These constructions have been investigated in spoken languages from a syntactic, semantic, and typological point of view. However, very few studies have focused on this topic in sign languages. Our paper aims to fill this gap by investigating the syntax of temporal constructions in LSF from a syntactic perspective and to systematically compare them to their LIS counterparts studied in Aristodemo (2017).

Our paper is organized as follows: Section 2 presents an overview of temporal constructions in spoken languages as well as a number of diagnostic tools to identify the different syntactic strategies. Section 3 focuses on sign languages and, in particular, we report the case of LIS temporal constructions for which these tools have been applied by Aristodemo (2017). In Section 4, we apply the same diagnostics to LSF data, showing that LSF temporal constructions are instances of asymmetric coordination. Section 5 integrates LSF results in a typological perspective and finally, Section 6 concludes the paper.

## 2 TEMPORAL CONSTRUCTIONS IN SPOKEN LANGUAGE: TYPOLOGY AND DIAGNOSTICS

In spoken languages, temporal constructions are usually conveyed by a complex syntactic structure which involves two clauses. The most common strategy used to express them is subordination, namely a configuration where one clause is syntactically dependent on another. Semantically, temporal constructions express a temporal relation between the events described by the two clauses (Thompson & Longacre 1985). This relation can be of precedence, succession or simultaneity, as illustrated respectively by the English *before*-, *after*-, and *when*-clauses in (1).

- (1) a. John arrived [<sub>sub</sub> **before** Marie fell].  
 b. John arrived [<sub>sub</sub> **after** Marie fell].  
 c. John arrived [<sub>sub</sub> **when** Marie fell].

In several languages, *before*-clauses are characterized by the presence of negation. This is due to the semantic interpretation of the construction since it states that the event expressed by the subordinate clause has not yet happened by the time at which the event named in the main clause took place. The presence or absence of negation is a typological parameter of variation. For instance, a negative marker is optional in Mandarin, while it is obligatory in Lakota, as illustrated in (2) and (3).

- (2) *Mandarin* (Thompson & Longacre 1985: 248)  
 [<sub>sub</sub> Ta (mei) lai yiqian], women yijing hui jia le.  
 he (NEG) come before we already return home ASP  
 ‘Before he arrived, we had already gone home.’

- (3) *Lakota* (Buechel 1939: 251)  
 [<sub>sub</sub> T’e ni it’okab] c’inca-pi kin wahokon-wica-kiye.  
 die NEG before child-PL the admonish-3PL-P  
 ‘Before he died, he admonished his children.’

Negation can also be observed in languages such as Italian and French (cf. (4)–(5)), while in English the negative environment can be made visible through the presence of negative polarity items (NPIs), such as *any* and *ever* (cf. (6)).

- (4) *Italian* (Del Prete 2008: 161)  
 Lo fermerai [<sub>sub</sub> prima che non faccia qualche sciocchezza].  
 him stop.2SG.FUT before that not do.3SG.SBJV some folly.SG.F  
 ‘You will stop him before he does anything silly.’

- (5) *French*  
 Je pars [<sub>sub</sub> avant qu' elle ne vienne].  
 I leave.1SG.PRS before that she not come.1SG.PRS  
 'I leave before she arrives.'

- (6) *English*  
 a. You should get more information [<sub>sub</sub> before making any decision].  
 b. [<sub>sub</sub> Before I ever heard of generative grammar], I knew Chomsky's name from his political essays.

Temporal information can also be expressed using other syntactic strategies. One possibility is juxtaposition, which involves two independent clauses (cf. (7)).

- (7) *French*  
 Pierre a mangé. Après Marie est tombée.  
 Pierre have.3SG eat.PST.PTCP after Marie be.3SG fall.PST.PTCP.F  
 'Pierre ate. After that, Marie fell.'

Another strategy is asymmetric coordination in which the two clauses are coordinated, as in (8).

- (8) *French*  
 Pierre a mangé et après Marie est tombée.  
 Pierre have.3SG eat.PST.PTCP and after Marie be.3SG fall.PST.PTCP.F  
 'Pierre ate and after that Marie fell.'

The asymmetry in (8) comes from the temporal adverb which creates a clear semantic dependency between the time of the two events. Without the temporal adverb, the two propositions would be symmetrically coordinated, allowing them to alternate between the positions of first and second conjunct without changing the meaning, as illustrated in (9).

- (9) *French*  
 a. Pierre a mangé et Marie est tombée.  
 Pierre have.3SG eat.PST.PTCP and Marie be.3SG fall.PST.PTCP.F  
 'Pierre ate and Marie fell.'  
 b. Marie est tombée et Pierre a mangé.  
 Marie be.3SG fall.PST.PTCP.F and Pierre have.3SG eat.PST.PTCP  
 'Marie fell and Pierre ate.'

By contrast, in asymmetric coordination, inverting the two conjuncts provokes a change in meaning, as shown in (10a) and (10b), such that the two events are not ordered with respect to each other anymore (Culicover & Jackendoff 1997; De Vries 2008).

- (10) *French*  
 a. Pierre achètera un portable et après Marie appellera sa maman.  
 Pierre buy.3SG.FUT a cellphone and after Marie call.3SG.FUT POSS.3SG.F mom  
 'Pierre will buy a cellphone and after that, Marie will call her mom.'  
 b. Après Marie appellera sa maman et Pierre achètera un portable.  
 after Marie call.3SG.FUT POSS.3SG.F mom and Pierre buy.3SG.FUT a cellphone  
 'Later Marie will call her mom and Pierre will buy a cellphone.'

In some cases, temporal constructions are also expressed by using relative clauses.<sup>1</sup> This is the case in Mandarin, where the head noun *shihou* 'time' is used, as in (11), or in Swahili, in which the relative marker *po* is inserted in the subordinate clause, as shown in (12).

- (11) *Mandarin* (Thompson & Longacre 1985: 247)  
 [<sub>sub</sub> ta lai de shihou] women dou zou le  
 he come REL time we all leave ASP  
 'When he arrived, we all left.'

<sup>1</sup> Bhatt & Pancheva (2007) propose an analysis of *when*-clauses in terms of free relatives.

- (12) *Swahili* (Thompson & Longacre 1985: 247)  
 [<sub>sub</sub> baba a-na-po-pika chakula], kuna pilipili sana.  
 father SBJV-PRS-REL-cook food there-is pepper plenty  
 ‘When father cooks, there is plenty of pepper.’

From a morphological point of view, all the complex syntactic configurations presented so far display distinguishing properties: coordination is often characterized by the presence of a conjunction (like *and* in English, *et* in French, or *e* in Italian); juxtaposition does not contain a conjunction; subordination contains elements such as complementizers (like *that* in English, *que* in French, or *che* in Italian), relative pronouns and/or relative particles (like *po* in Swahili).

In the generative framework, there are several syntactic tests that can be used as diagnostics for the underlying syntactic structure of the constructions: inversion, possibility to stand in isolation, and *wh*-extraction (Ross 1967). Inversion applied to juxtaposed clauses results in a structure that is pragmatically odd with respect to Grice (1975)’s manner maxims. More precisely, uttering two sentences in a misleading order leads to oddity, as in (13).

- (13) *French*  
 a. Pierre achètera un portable. Après Marie appellera sa maman.  
 Pierre buy.3SG.FUT a cellphone after Marie call.3SG.FUT POSS.3SG.F mom  
 ‘Pierre will buy a cellphone. After Marie will call her mom.’  
 b. #Après Marie appellera sa maman. Pierre achètera un portable.  
 after Marie call.3SG.FUT POSS.3SG.F mom Pierre buy.3SG.FUT a cellphone

In asymmetric coordination, inversion changes the meaning,<sup>2</sup> as previously illustrated in example (10) repeated here in (14).

- (14) *French*  
 a. Pierre achètera un portable et après Marie appellera sa maman.  
 Pierre buy.3SG.FUT a cellphone and after Marie call.3SG.FUT POSS.3SG.F mom  
 ‘Pierre will buy a cellphone and after that Marie will call her mom.’  
 b. Après Marie appellera sa maman et Pierre achètera un portable.  
 after Marie call.3SG.FUT POSS.3SG.F mom and Pierre buy.3SG.FUT a cellphone  
 ‘Later, Marie will call her mom and Pierre will buy a cellphone.’

In subordinate temporal clauses, inversion is acceptable and does not change the original ordering, as shown in (15). The event described by the subordinate clause happens before the event described by the main one.

- (15) *French*  
 a. Marie appellera sa maman [<sub>sub</sub> après que Pierre aura  
 Marie call.3SG.FUT POSS.3SG.F mom after that Pierre have.3SG.FUT  
 acheté un portable].  
 buy.PST.PTCP a cellphone  
 ‘Marie will call her mom after Pierre buys a cellphone.’  
 b. [<sub>sub</sub> Après que Pierre aura acheté un portable,] Marie appellera  
 after that Pierre have.3SG.FUT buy.3SG a cellphone Marie call.3SG.FUT  
 sa maman.  
 POSS.3SG.F mom  
 ‘After Pierre buys a cellphone, Marie will call her mom.’

Moving to the isolation test, we observe that juxtaposed sentences can be expressed in isolation (cf. (16)), while coordinated or subordinated clauses cannot (cf. (17) and (18)). While in (17), it is odd to find a coordinator introducing a sentence out of the blue, the sentence in (18) is ungrammatical since it is a dependent subordinate clause headed by a complementizer.

<sup>2</sup> Note that in this case, we keep the conjunction between the two clauses. Otherwise, it would result in agrammaticality.

- (16) *French*  
 Après Marie prendra le train.  
 after Marie take.3SG.FUT the train  
 ‘Later on, Marie will take the train.’
- (17) *French*  
 #Et après Marie prendra le train.  
 and after Marie take.3SG.FUT the train
- (18) *French*  
 \*Après que Pierre achètera le portable.  
 after that Pierre buy.3SG.FUT the cellphone.

The three different strategies also behave differently as far as extraction possibilities are concerned, as illustrated by the English sentences in (19)–(21). Given that the structures we are interested in contain two clauses, *wh*-extraction can be performed, in principle, in two different ways. The first possibility is to extract symmetrically the *wh*-element from the two clauses at the same time. When the two clauses are coordinated, this is called Across-The-Board (ATB) strategy and it forces the two gaps to refer to the same object (they are co-indexed).<sup>3</sup> In the case of subordinated sentences, symmetric extraction involves parasitic gaps which are also interpreted as being co-indexed. The second possibility is to extract asymmetrically either from one clause or the other. This test is particularly useful with subordinated structures as it reveals the syntactic status of the two clauses: extraction is possible from the main clause but not from the temporal subordinated clause.<sup>4</sup>

- (19) Paul bought strawberries. After that, Marie stole a bike.  
 a. \***What** did Paul buy \_\_\_\_. After that, Marie stole \_\_\_\_?  
 b. \***What** did Paul buy \_\_\_\_. After that, Marie stole a bike?  
 c. \***What** did Paul buy strawberries. After that, Marie steal \_\_\_\_?
- (20) Paul bought strawberries and after that, Marie stole a bike.  
 a. **What**<sub>*i*</sub> did Paul buy \_\_\_\_<sub>*i*</sub> and after that, Marie steal \_\_\_\_<sub>*i*</sub>?  
 b. \***What** did Paul buy \_\_\_\_ and after that, Marie stole a bike?  
 c. \***What** did Paul buy strawberries and after that, Marie steal \_\_\_\_?
- (21) Paul bought strawberries [<sub>*sub*</sub> after Marie stole a bike].  
 a. **What**<sub>*i*</sub> did Paul buy \_\_\_\_<sub>*i*</sub> [<sub>*sub*</sub> after Marie stole \_\_\_\_<sub>*i*</sub>]?  
 b. **What** did Paul buy \_\_\_\_ [<sub>*sub*</sub> after Marie stole a bike ]?  
 c. \***What** did Paul buy strawberries [<sub>*sub*</sub> after Marie stole \_\_\_\_]?

The examples in (19) show that, in juxtaposition, it is not possible to ask a question either symmetrically or asymmetrically. As expected for coordination, the examples in (20) show that only the symmetric extraction is permitted through an ATB strategy (see (20a)). In such structures, asking a question from only one of the two conjuncts always results in ungrammaticality (cf. (20b)–(20c)).

Finally, subordinated temporal clauses (cf. (21)) allow extraction in a symmetrical fashion (cf. (21a)) and from the main clause (see (21b)) but, crucially, not from the subordinated one (21c).

**Table 1** summarizes the results of all the tests applied to the three syntactic configurations and their expected cross-linguistic outcomes.

	INVERSION	ISOLATION	WH-EXTRACTION		
			SYMMETRIC	ASYMMETRIC	
Juxtaposition	#	✓	X	X	
Coordination	Change meaning	X	✓ (ATB)	X	
Subordination	✓	X	✓	Sub. clause	
				Main clause	
				X	✓

**Table 1** Summary of the test outcomes depending on syntactic properties.

<sup>3</sup> In the examples, co-indexation is indicated by using the same subscript letter as in (20a).  
<sup>4</sup> The impossibility to extract from the subordinate clause is due to the adjunct island constraint violation (Ross 1967).

This section briefly presents how temporal information is expressed in sign languages. We then focus on temporal constructions by describing the case of Italian Sign Language studied by Aristodemo (2017).

#### 3.1 EXPRESSING TIME IN SIGN LANGUAGE

In Sinte (2015)'s book "Le temps en langue des signes" (i.e. 'Time in signed languages'), the author offers a review of how time is expressed across sign languages. Along the lines of previous cross-linguistic studies (Pfau et al. 2012), the author remarks that temporality is mainly expressed through lexical items, spatial timelines, and non-manual markers (NMM). In fact, all these components interact to express fine-grained degrees of temporal relations.

Regarding the lexical items, Pfau et al. (2012) show that, in sign languages, the time referred to in the utterance is primarily indicated through temporal adverbials, just like in spoken languages. Cross-linguistically, temporal adverbs can be sentence-initial, sentence-final and/or between the subject and the verb. For example, American Sign Language (ASL) displays all three possibilities, as shown in (22).<sup>5</sup>

- (22) ASL (Aarons 1994: 238)
- a. **TOMORROW** J-O-H-N BUY CAR  
 'John will buy a car tomorrow.'
  - b. J-O-H-N BUY CAR **TOMORROW**  
 'John will buy a car tomorrow.'
  - c. J-O-H-N **TOMORROW** CAN BUY CAR  
 'John can buy a car tomorrow.'

Many authors, including Brennan (1983) for British Sign Language, Engberg-Pedersen (1993) for Danish Sign Language, Johnston (1991) for Australian Sign Language, Pizzuto et al. (1995) for LIS and Sallandre (2007) for LSF, argue that time is visually represented in the signing space. Sinte (2015) lists a total of six different timelines that are described in sign language literature (see the illustration we realized in [Figure 1](#)). Only the main timeline, which is visualized as a horizontal line going from behind the signer to in front of him/her (line 1 in [Figure 1](#)), is consistently described cross-linguistically. As we will see, this line is relevant for Aristodemo (2017)'s analysis of temporal clauses as involving visible degrees of time, as described in Section 3.2.

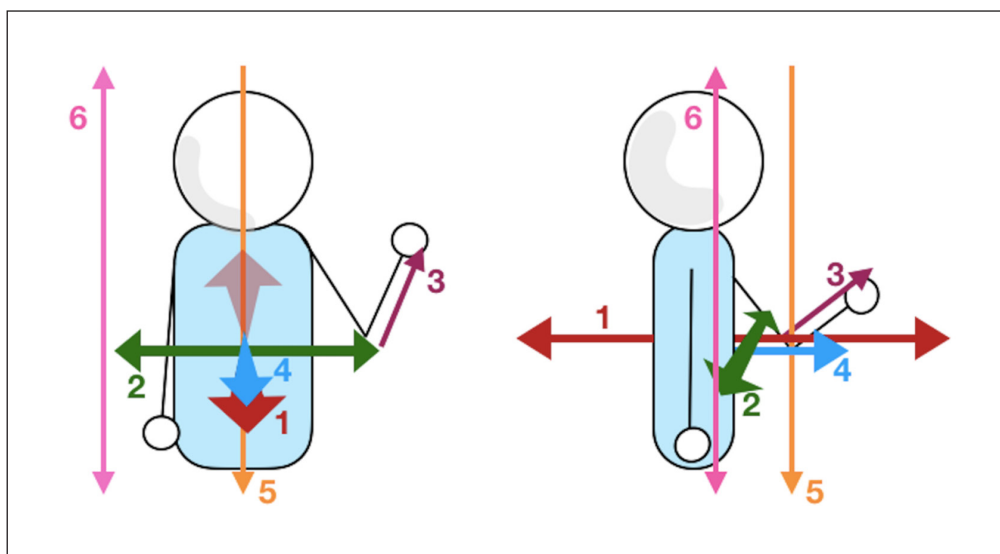

**Figure 1** Timelines in space.

<sup>5</sup> In the paper, sign language examples are glossed in small capital letters. Non-manual marking is indicated by a line extending above the elements it marks, and the abbreviation above the line indicates its type. Subscripts are used to indicate the semantic reference. If two or more elements share the same index, they are co-referent. Pronouns are usually realized through pointing towards a locus that is associated with the person it refers to (ix-1 for the first person, ix-2 for the second, or ix-3 for the third). Finally, fingerspelled words are indicated through the use of hyphens between the letters.

Traugott (1978) and Pizzuto et al. (1995) argue that sign languages are not so different from spoken languages since they both represent time metaphorically as going forward or backward. What makes sign languages special is that they have the ability to make the metaphor visible.<sup>6</sup>

### 3.2 TEMPORAL CONSTRUCTIONS IN LIS

The first description of temporal adverbs in LIS comes from Pizzuto et al. (1995) who describe the phonological, morphological and semantic properties of eight different spatio-temporal signs. In their paper, Pizzuto et al. (1995) argue that some temporal adverbs can only be used in coordinated contexts (e.g. the sign *FIRST*) while others (e.g. *BEFORE*) can be “the only appropriate choice when the relation between two events placed in a sequence is one of subordination” (Pizzuto et al. 1995: 245). However, they do not provide any supporting evidence for this claim.

Aristodemo (2017) filled this gap by providing a detailed analysis of LIS temporal clauses in terms of subordinated structures akin to relativization. Her account is supported by both the presence of non-manual markers and the result of the application of the diagnostic tools presented in Section 2. The following examples illustrate respectively a *before*-, a *when*- and an *after*-clause in LIS.

(23) LIS (Aristodemo 2017: 83)

- a. [<sub>sub</sub> BOSS STOCK SELL <sup>re</sup> NOT-YET/MUST<sub>future</sub> [ <sup>NMM</sup> BEFORE ]], SECRETARY STAMP BUY
- b. [<sub>sub</sub> BOSS STOCK SELL [ <sup>re</sup> MOMENT PI/SAME ]], SECRETARY STAMP BUY
- c. [<sub>sub</sub> BOSS STOCK SELL [ <sup>re</sup> AFTER ]], SECRETARY STAMP BUY
- ‘The secretary bought the stamps { before when after } the boss sold the stocks.’

LIS temporal constructions display two prosodic breaks which are realized at the beginning and at the end of the temporal marker. Regarding non-manual marking, temporal constructions in LIS display two different types of eyebrow raising. The first (i.e. *re*) spreads on the temporal clause, while the second is a cluster of nonmanuals (wide eye opening, further raising of the eyebrows and a nod), indicated as *NMM*, which spreads on the temporal marker only.<sup>7</sup> This type of distribution of non-manuals is typical of other subordinate clauses, such as *if*-clauses, left dislocated sentential complements and comparative correlatives in which raised eyebrows spread on the entire clause.

From a morphological point of view, *before*-clauses involve the presence of either the negative word *NOT-YET* or the future marker *MUST<sub>future</sub>* (cf. (23a)), while *after*- and *when*-clauses do not. Furthermore, in *when*-clauses the temporal relation is expressed using *MOMENT* followed by *SAME* or by the relative marker *PI*<sup>8</sup> (cf. (23b)).

Moving to syntactic properties, Aristodemo (2017) shows that temporal constructions in LIS have a fixed order. Indeed, it is not possible to invert the two clauses as shown by the ungrammatical sentences from (24) to (26). This property has already been observed for other types of subordinated structures in LIS, such as *if*-clauses (Barattieri 2006) and, crucially, is not true of LIS juxtaposed and coordinated clauses (Aristodemo 2017). Note that the same observation has been made by Wilbur (2016) for adverbial clauses in ASL. In this respect temporal clauses in LIS and ASL behave differently from their spoken language counterparts in which inversion is allowed, as already shown in example (15) in Section 2.

<sup>6</sup> Pfau et al. (2012) observe that the reference of the metaphor could vary depending on the surrounding culture. For example, while LIS, ASL and LSF conceptualize the space in front of the signer as being the future, other sign languages might attribute the same space to the past.

<sup>7</sup> The various markers may align differently, as observed by Aristodemo (2017).

<sup>8</sup> The gloss *PI* is taken from Aristodemo (2017)’s thesis but it is exactly the same as *PE* described in Donati & Branchini (2009).



(24) LIS (Aristodemo 2017: 86)

- a. \***BEFORE** SECRETARY STAMP BUY BOSS STOCK SELL NOT-YET/MUST<sub>future</sub>
- b. \***BEFORE** BOSS STOCK SELL NOT-YET/MUST<sub>future</sub> SECRETARY STAMP BUY
- c. \*SECRETARY STAMP BUY BOSS STOCK SELL NOT-YET/MUST<sub>future</sub> **BEFORE**  
 (Intended meaning: ‘The secretary bought the stamps before the boss sold the stocks.’)

(25) LIS (Aristodemo 2017: 86)

- a. \***MOMENT PI/SAME** SECRETARY STAMP BUY BOSS STOCK SELL
- b. \***MOMENT PI/SAME** BOSS STOCK SELL SECRETARY STAMP BUY
- c. \*SECRETARY STAMP BUY BOSS STOCK SELL **MOMENT PI/SAME**  
 (Intended meaning: ‘The secretary bought the stamps when the boss sold the stocks.’)

(26) LIS (Aristodemo 2017: 87)

- a. \***AFTER** SECRETARY STAMP BUY BOSS STOCK SELL
- b. \***AFTER** BOSS STOCK SELL SECRETARY STAMP BUY
- c. \*SECRETARY STAMP BUY BOSS STOCK SELL **AFTER**  
 (Intended meaning: ‘The secretary bought the stamps after the boss sold the stocks.’)

Applying the isolation test (cf. (27)), Aristodemo (2017) rejects the juxtaposed analysis.<sup>9</sup>

(27) LIS (Aristodemo 2017: 87)

$$* \overline{\text{BOSS STOCK SELL (NOT-YET)}} \left. \begin{array}{c} \text{re} \\ \left\{ \begin{array}{c} \text{NMM} \\ \text{BEFORE} \\ \text{NMM} \\ \text{MOMENT PI} \\ \text{NMM} \\ \text{AFTER} \end{array} \right\} \end{array} \right\}$$

Finally, as expected for subordinate clauses, *wh*-extraction is possible only from the second clause,<sup>10</sup> as shown in (28), but not from the first one (cf. (29)). This asymmetric pattern shows that the first clause is the subordinate clause and the second clause is the main one (Ross 1967), as explained in the previous section.

(28) LIS (Aristodemo 2017: 88)

- a. [<sub>sub</sub>  $\overline{\text{BOSS STOCK SELL NOT-YET/MUST}}_{\text{future}}$   $\overline{\text{BEFORE}}$  ] t<sub>who</sub> STAMP BUY **WHO**
- b. [<sub>sub</sub>  $\overline{\text{BOSS STOCK SELL MOMENT PI}}$  ] t<sub>who</sub> STAMP BUY **WHO**
- c. [<sub>sub</sub>  $\overline{\text{BOSS STOCK SELL AFTER}}$  ] t<sub>who</sub> STAMP BUY **WHO**  
 ‘Who bought the stamps  $\left\{ \begin{array}{c} \text{before} \\ \text{when} \\ \text{after} \end{array} \right\}$  the boss sold the stock?’

(29) LIS (Aristodemo 2017: 88)

- a. \* t<sub>who</sub>  $\overline{\text{STOCK SELL NOT-YET/MUST}}_{\text{future}}$   $\overline{\text{BEFORE}}$ , SECRETARY STAMP BUY **WHO**
- b. \* t<sub>who</sub>  $\overline{\text{STOCK SELL MOMENT PI}}$ , SECRETARY STAMP BUY **WHO**
- c. \* t<sub>who</sub>  $\overline{\text{STOCK SELL AFTER}}$ , SECRETARY STAMP BUY **WHO**  
 (Intended meaning: Who is such that the secretary bought the stamps,  $\left\{ \begin{array}{c} \text{before} \\ \text{when} \\ \text{after} \end{array} \right\}$  s/he sold the stock?)

<sup>9</sup> Aristodemo argues that the adverbial forms a constituent with the main clause. See Aristodemo (2017) for more details on this aspect.

<sup>10</sup> We use the terms “first” and “second” clause to describe the surfacing order of the two clauses while staying theoretically neutral. The properties of juxtaposition, subordination or coordination are later deduced from the results of the syntactic tests.

Extraction from both clauses is also possible, as shown by the sentences in (30) and (31). Aristodemo (2017) argues that these are instances of parasitic gaps (pg in the glosses).<sup>11</sup>

- (30) LIS (Aristodemo 2017: 88)
- a. [<sub>sub</sub> <sup>topic</sup> PIZZA GIANNI \_\_\_\_<sub>pg</sub> EAT NOT-YET/MUST<sub>future</sub> BEFORE ] PIERO  
<sub>t<sub>pizza</sub></sub> PAY (DONE)  
 ‘As for pizza, Piero paid for (it) before Gianni ate (it).’
  - b. [<sub>sub</sub> <sup>topic</sup> PIZZA GIANNI \_\_\_\_<sub>pg</sub> EAT MOMENT PI], PIERO <sub>t<sub>pizza</sub></sub> PAY (DONE)  
 ‘As for pizza, Piero paid for (it) when Gianni ate (it).’
  - c. [<sub>sub</sub> <sup>topic</sup> PIZZA GIANNI \_\_\_\_<sub>pg</sub> EAT AFTER ], PIERO <sub>t<sub>pizza</sub></sub> PAY (DONE)  
 ‘As for pizza, Piero paid for (it) after Gianni ate (it).’

- (31) LIS (Aristodemo 2017: 88)
- a. ?? [<sub>sub</sub> GIANNI \_\_\_\_<sub>pg</sub> EAT NOT-YET/MUST<sub>future</sub> BEFORE], PIERO <sub>t<sub>what</sub></sub>  
<sub>wh</sub>  
 PAY (DONE) WHAT  
 ‘What did Piero pay for before Gianni ate?’
  - b. ?? [<sub>sub</sub> GIANNI \_\_\_\_<sub>pg</sub> EAT MOMENT PI], PIERO <sub>t<sub>what</sub></sub> PAY (DONE)  
<sub>wh</sub>  
WHAT  
 ‘What did Piero pay for when Gianni ate?’
  - c. ?? [<sub>sub</sub> GIANNI \_\_\_\_<sub>pg</sub> EAT AFTER], PIERO <sub>t<sub>what</sub></sub> PAY (DONE) WHAT  
<sub>wh</sub>  
 ‘What did Piero pay for after Gianni ate?’

To summarize, LIS temporal constructions involve a subordinate clause. They are characterized by a fixed order with the subordinate clause preceding the main clause and the temporal marker between them. All the properties just discussed point towards this conclusion and are summarized in [Table 2](#). Remember that the impossibility to invert the two clauses is not an issue, on the contrary, it is a typical feature displayed by LIS subordinated clauses (Donati & Branchini 2009).

	INVERSION	ISOLATION	WH-EXTRACTION	
			SYMMETRIC	ASYMMETRIC
Juxtaposition	#	✓	X	X
Coordination	Change meaning	X	✓ (ATB)	X
Subordination	✓	X	✓	Sub. clause Main clause
				X ✓
<b>LIS</b>	X	X	✓	X ✓

**Table 2** Summary of the syntactic properties of LIS.

In her analysis, Aristodemo (2017) proposes that the subordinate clause is headed by a degree phrase (DegP) which is generated as a vP adjunct and is then left-adjoined to the main IP, as shown in (32). The choice of the DegP is justified by a semantic analysis in terms of comparative constructions. Indeed, she argues that in temporal constructions, the temporal scale is iconically represented as a set of ordered points along the first timeline (line 1 in [Figure 1](#)). Temporal markers, as comparatives markers, express a relation between two degrees of time.

<sup>11</sup> The acceptability judgments of the examples in (31) are degraded due to the fact that without the “licit” gap, the gap inside the temporal clause is not easily interpretable as co-referring with the object of the main clause. See Aristodemo (2017) for more details on this issue.

(32) *Temporal constructions in LIS*

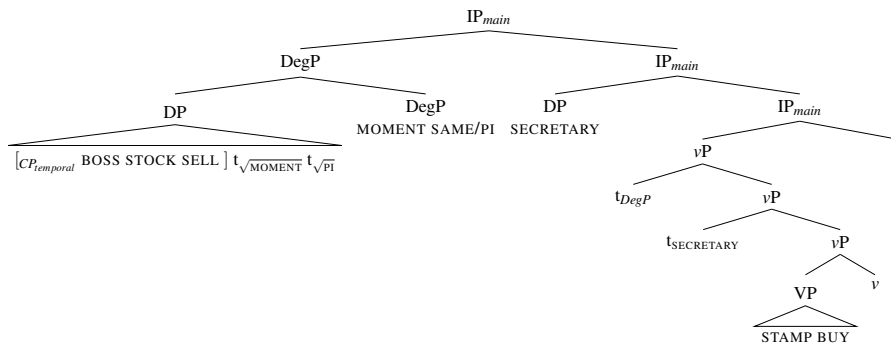

## 4 INVESTIGATING TEMPORAL CONSTRUCTIONS IN FRENCH SIGN LANGUAGE (LSF)

We can now use the diagnostic tests to investigate temporal constructions in LSF. Doing so, we will verify whether the conclusions just drawn for LIS can extend to this neighboring language. Indeed, according to Cantin (2016), LIS is historically related to LSF, hence it is plausible that the two sign languages use the same strategy to express temporal clauses.

### 4.1 METHODOLOGY

This work is based on fieldwork, using elicitation and playback methods. We collected our data from three native signers, who regularly collaborate with us, a man and two women all aged between 29 and 40 years.

Before starting data collection, informants were told that we were interested in the documentation of possible sentences in LSF. They had no precise knowledge of our research questions and goals. The elicitation was conducted in two major steps: picture-based elicited production<sup>12</sup> and a syntactic analysis. All the data produced by our informants were video recorded, transcribed, and glossed. The first step of the elicitation consisted in asking for the description of paired pictures. We asked the informants to produce a sentence for each picture, and, only after, to sign a complex sentence in which the two events were temporally related. It was left to the informants to decide of the temporal relation he/she wanted to produce. Once the first sentence was produced, we explicitly asked the informants to change the temporal relation of the same events. The target sentences obtained using the pictures in *Figure 2* are shown in (33).



**Figure 2** Example of elicitation picture for the target sentences in (33).

<sup>12</sup> Different kind of pictures were presented, some ordered in pairs and others with simultaneous events depicted (such as a burglar pointing a gun at a seller who is closing his boutique).

- (33) a. MARIE BUY FLOWER  
 ‘Marie bought flowers.’
- b. MARIE STEAL BIKE  
 ‘Marie stole a bike.’
- c.
- $$[{}_{left} \text{JEAN BUY FLOWER}] \left\{ \begin{array}{c} \text{BEFORE} \\ \text{SAME TIME} \\ \text{AFTER} \end{array} \right\}^{\text{re}} [{}_{right} \text{MARIE STEAL BIKE}]$$
- ‘Jean bought flowers and before/at the same time/after Marie stole a bike.’

The main advantage of this elicitation methodology is that there is no influence of either written French or any other bias from the researcher. Once the baselines were obtained, we proceeded with the syntactic investigation.

For this second phase, we asked the informants to manipulate the baselines (e.g., truncate them and invert the two clauses) and to produce new alternatives (e.g., questions) following the diagnostic tests. If the informants refused categorically to sign a sentence, we considered it as evidence that the sentence was ungrammatical. When informants agreed to sign an alternative, we recorded it and made them judge it in another session, along with all the other sentences. This methodology allowed us to record more positive data and to add, even more importantly, some negative evidence. Following the “playback method” (Schlenker 2010), every utterance obtained in the recording session was played back in a different session and rated again by all the informants. This procedure was applied to make sure that the data obtained could be generalized.

For each sentence, informants had to give a judgment on a seven-point scale regarding two different aspects: acceptability (i.e., does the sentence seem natural in LSF?) and felicity (i.e., does the sentence describe the picture accurately?). We only present the sentences that were judged accordingly across all informants. In order to simplify the reading process of the LSF examples, we use the symbols that are conventionally adopted in the linguistic literature. The correspondence between grading and symbols is given in [Table 3](#).

GRADE	NOTATION	INTERPRETATION
1	*	Unacceptable
2	*	Unacceptable
3	?*	Degraded
4	??	Marginally acceptable
5	?	Relatively acceptable
6		Acceptable
7		Acceptable

**Table 3** Codification of acceptability and felicity judgments.





## 4.2 THE BASELINE

The baselines of temporal clauses in LSF are presented in (34). This paper focuses on constructions that contain the temporal adverbs AFTER, BEFORE and SAME TIME, leaving aside other types of temporal constructions which are worth further investigation. The glosses in (34) include information about non-manual markers (*re* indicates raised eyebrows) and localization of signs in space (square brackets coupled with *left* or *right* indicate the side on which the sentence is signed).

- (34) a.  $[{}_{left} \text{JEAN BUY FLOWER}] \overline{\text{AFTER}}^{\text{re}} [{}_{right} \text{MARIE STEAL BIKE}]$   
 ‘Jean bought flowers and after Marie stole a bike.’
- b.  $[{}_{left} \text{JEAN BUY FLOWER}] \overline{\text{BEFORE}}^{\text{re}} [{}_{right} \text{MARIE STEAL BIKE}]$   
 ‘Jean bought flowers and before Marie stole a bike.’
- c.  $[{}_{left} \text{JEAN BUY FLOWER}] \overline{\text{SAME TIME}}^{\text{re}} [{}_{right} \text{MARIE STEAL BIKE}]$   
 ‘Jean bought flowers and at the same time Marie stole a bike.’

We see in (34) that, no matter the temporal marker, the use of space is the same: the first clause is signed on the left side of the signing space while the second is realized on the right. It is worth noting that the spatialization pattern is typical of coordinated structures in sign languages descriptions (Quer et al. 2017) and has also been described for symmetric coordination in LSF (Geraci 2017), as in example (35). Importantly, it differs from the one found in LIS baselines.

(35) [<sub>left</sub> AGATHE PLANT TOMATO] [<sub>right</sub> MARIE PLANT FLOWER]  
 ‘Agathe plants tomatoes and Marie plants flowers.’

As for the manual signs, **Figure 3** illustrates the LSF temporal markers used by our informants. AFTER is signed with the handshape . BEFORE is also articulated with a  handshape but it has a backward movement. Finally, SAME TIME is a complex sign composed of two sub-parts, the sign for SAME is a symmetrical two-handed sign with a  handshape, while the sign for TIME has a forward movement with a handshape change from  to .

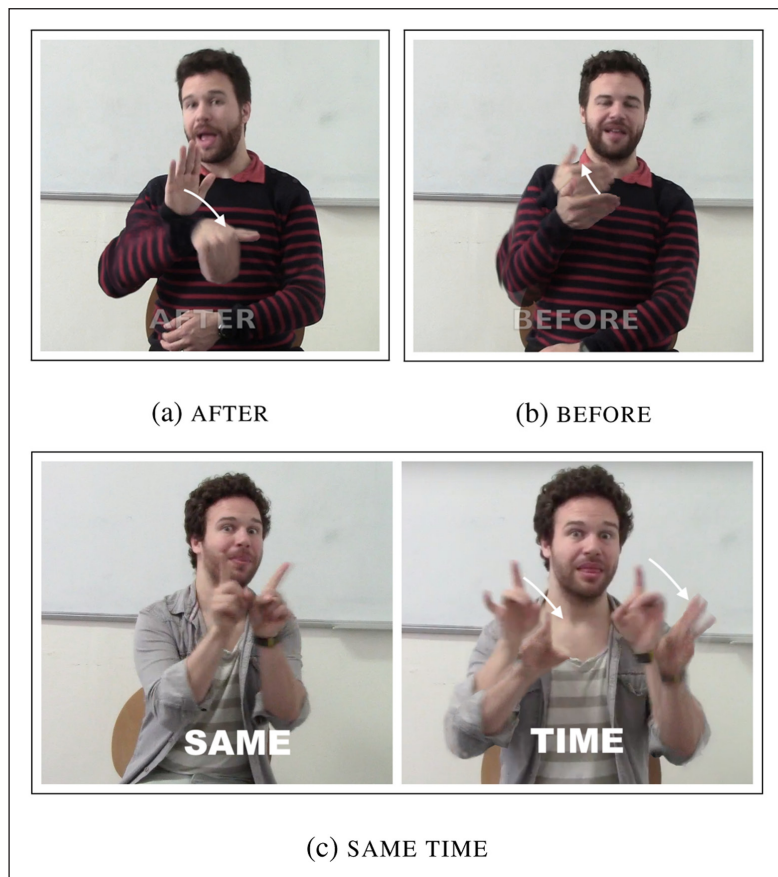

**Figure 3** The signs AFTER (a), BEFORE (b) and SAME TIME (c).

The temporal markers in (34a)–(34c) are signed in the middle of the signing space and are marked by raised eyebrows as illustrated in **Figure 4**. Differently from LIS, there is no prosodic breaks observed before or after the temporal markers.



**Figure 4** Non-Manual marking in LSF.

To allow a direct comparison with LIS, we first tested the possibility of inserting the relative pronoun *PI* (Hauser & Geraci 2017) and the negation *NOT-YET*. Neither is possible, as shown by the ungrammatical sentences in (36) and (37). In particular, the sentence in (36) shows that

the temporal marker *SAME TIME* cannot be replaced by *TIME PI* to create a relative clause headed by the noun *TIME*. In this respect, contra to LIS, we have no clear indication of the presence of subordination.

- (36) \* [*left* JEAN BUY FLOWER ]  $\overline{\text{TIME PI}}^{\text{re}}$  [*right* MARIE BUY VASE]  
 (Intended meaning: ‘Jean bought flowers at the moment at which Marie bought a vase.’)

Moreover, the presence of the negation ‘NOT-YET’ results in agrammaticality (cf. (37)). This shows that LSF does not pattern like languages such as Mandarin, Lakhota or LIS since it does not require negation to appear in *before*-clauses.

- (37) a. \* [*left* JEAN BUY FLOWER ]  $\overline{\text{BEFORE}}^{\text{re}}$  [*right* MARIE BUY VASE NOT-YET]  
 b. \* [*left* JEAN BUY FLOWER NOT-YET ]  $\overline{\text{BEFORE}}^{\text{re}}$  [*right* MARIE BUY VASE]  
 (Intended meaning: ‘John bought flowers before Marie had not yet bought a vase.’)

### 4.3 TESTING THE SYNTACTIC PROPERTIES

In this section we test how LSF temporal constructions behave with respect to the diagnostics we introduced in Section 2. This fine-grained investigation is necessary to establish the nature of the syntactic relation between the two clauses of LSF temporal constructions. To verify if the construction involves two separate sentences, we tested whether they can stand alone. The results are presented from (38a) to (38d).

- (38) [*left* JEAN BUY FLOWERS ]  $\left\{ \begin{array}{c} \text{BEFORE} \\ \text{SAME TIME} \\ \text{AFTER} \end{array} \right\}^{\text{re}}$  [*right* MARIE BUY VASE ]  
 ‘Jean bought flowers and after/before/at the same time Marie bought a vase.’  
 a.  $\overline{\text{BEFORE}}^{\text{re}}$  MARIE BUY VASE  
 ‘Before (now), Marie bought a vase.’  
 b.  $\overline{\text{SAME TIME}}^{\text{re}}$  MARIE BUY VASE  
 ‘At the same time (as now/as we are talking), Marie bought a vase.’  
 c.  $\overline{\text{AFTER}}^{\text{re}}$  MARIE BUY VASE  
 ‘After (now), Marie will buy a vase.’  
 d. JEAN BUY FLOWERS  
 ‘Jean bought flowers.’

The sentences (38a)–(38c) show that the second clause can be expressed in isolation, as well as the first one (cf.(38d)). However, given that no manual coordinator is present in LSF, it is difficult to determine whether the isolated clauses correspond exactly to the truncated construction or if the signer produces a new independent sentence. A strong piece of evidence in favor of the latter option is the absence of right localization of the sentences in (38a)–(38d). In addition, we also tested the possibility of having the temporal marker at the end of the first clause. This option is not available as shown by the sentence in (39). This can be used as an indication that the temporal marker needs to be followed by an event and belongs to the second clause.

- (39) \* JEAN BUY FLOWERS  $\left\{ \begin{array}{c} \text{BEFORE} \\ \text{SAME TIME} \\ \text{AFTER} \end{array} \right\}^{\text{re}}$

To deepen our investigation, we apply the inversion test. In this case, we observe that in LSF it is possible to swap the two clauses (cf. (40)). This result highlights an important difference between LIS and LSF. In the former, the inversion results in agrammaticality.

- (40)  $[_{left} \text{JEAN BUY FLOWER}] \left\{ \begin{array}{c} \text{BEFORE} \\ \text{SAME TIME} \\ \text{AFTER} \end{array} \right\} [_{right} \text{MARIE BUY VASE.}]$   
 ‘Jean bought flowers and after/before/at the same time Marie bought a vase.’
- a.  $\overline{\text{BEFORE}} [_{left} \text{MARIE BUY VASE}] [_{right} \text{JEAN BUY FLOWER}]$   
 ‘Before (now), Marie bought a vase and Jean bought flowers.’
- b.  $\overline{\text{SAME TIME}} [_{left} \text{MARIE BUY VASE}] [_{right} \text{JEAN BUY FLOWER}]$   
 ‘At the same time (as now), Marie bought a vase and Jean bought flowers.’
- c.  $\overline{\text{AFTER}} [_{left} \text{MARIE BUY VASE}] [_{right} \text{JEAN BUY FLOWER}]$   
 ‘After (now), Marie will buy a vase and Jean will buy flowers.’

However, if we compare the translation of the LSF sentences in (40) and those obtained after inversion in (40a)–(40c), we observe that the meaning changed after inversion. In the baseline, the events are temporally related one to the other. After inversion, the two events are both temporally located either before, at the same time or after the time in which the sentence is uttered but without any ordering relation between them. This change in meaning is expected in asymmetric coordination, as illustrated in Section 2.

The results of the inversion and the isolation tests, coupled with the pieces of evidence from non-manual components and spatial localization, converge towards an analysis in terms of a coordinated structure (see [Table 4](#) in Section 4.4 for a summary of the results). However, these results are not sufficient to fully exclude alternative analyses such as juxtaposed clauses.

The extraction tests will shed light on this matter. Here, predictions are straightforward: if extraction is permitted in both clauses at the same time, the syntactic structures cannot be juxtaposed. The symmetric extraction is compatible with both coordinated and subordinated clauses. On the other hand, asymmetric extraction is compatible with a subordination analysis only. The extraction pattern of LSF is presented in examples (41).<sup>13</sup>

- (41)  $[_{left} \text{JEAN BUY FLOWER}] \left\{ \begin{array}{c} \text{BEFORE} \\ \text{SAME TIME} \\ \text{AFTER} \end{array} \right\} [_{right} \text{MARIE STEAL BIKE}]$   
 ‘Jean bought flowers and before/at the same time/after Marie stole a bike.’
- a. *Extraction from the first clause only*
- \*  $[_{left} \text{WHO BUY FLOWER}] \left\{ \begin{array}{c} \text{BEFORE} \\ \text{SAME TIME} \\ \text{AFTER} \end{array} \right\} [_{right} \text{MARIE STEAL BIKE}]?$
- b. *Extraction from the second clause only*
- \*  $[_{left} \text{JEAN BUY FLOWER}] \left\{ \begin{array}{c} \text{BEFORE} \\ \text{SAME TIME} \\ \text{AFTER} \end{array} \right\} [_{right} \text{WHO STEAL BIKE}]?$
- c. *Symmetric extraction (ATB)*
- $[_{left} \text{WHO}_i \text{ BUY FLOWER}] \left\{ \begin{array}{c} \text{BEFORE} \\ \text{SAME TIME} \\ \text{AFTER} \end{array} \right\} [_{right} \text{---}_i \text{ STEAL BIKE}]?$   
 ‘Who bought flowers and before/at the same time/after stole a bike?’

The sentences in (41a) and (41b) show that asymmetric extraction is not possible, while the sentence in (41c) shows that across-the-board extraction is allowed. These results clearly points towards coordination and are not compatible with an analysis in terms of juxtaposition or subordination (see [Table 4](#) in Section 4.4).

#### 4.4 ANALYSIS

We analyze LSF temporal constructions as being coordinated clauses with a temporal marker in the second conjunct. This analysis is based on the sum of our observations: i) the spatial localization of LSF temporal clauses is typical of coordination; ii) it is ungrammatical to use

<sup>13</sup> Note that LSF uses mainly an in-situ strategy for questions (see Geraci 2017 and Hauser 2016), which explains the absence of gaps in (41c)–(41b).

a relative pronoun; iii) the two clauses can be inverted but inversion results in a different interpretation of the sentence and; iv) extraction can only be performed across-the-board. These results are summarized in [Table 4](#).

	INVERSION	ISOLATION	WH-EXTRACTION		
			SYMMETRIC	ASYMMETRIC	
Juxtaposition	#	✓	X	X	
Coordination	Change meaning	X	✓ (ATB)	X	
Subordination	✓	X	✓	Sub. clause	
				Main clause	
				X	✓
<b>LSF</b>	Change meaning	?	✓ (ATB)	X	

**Table 4** Summary of the syntactic tests for LSF.

We observe that temporal constructions in LSF behave consistently like coordinated structures with the exception of the isolation test. We attribute this difference to the absence of the typical spatial marking of coordination (i.e. right/left use of space) in the sentences expressed in isolation. As discussed in the previous section, this could be an attempt of the signer to rescue the sentences in order to produce simple declarative grammatical utterances.

We analyze LSF temporal clauses as two asymmetrically coordinated clauses, as shown in the syntactic structure in (42).

(42) *Surface structure of temporal constructions in LSF*

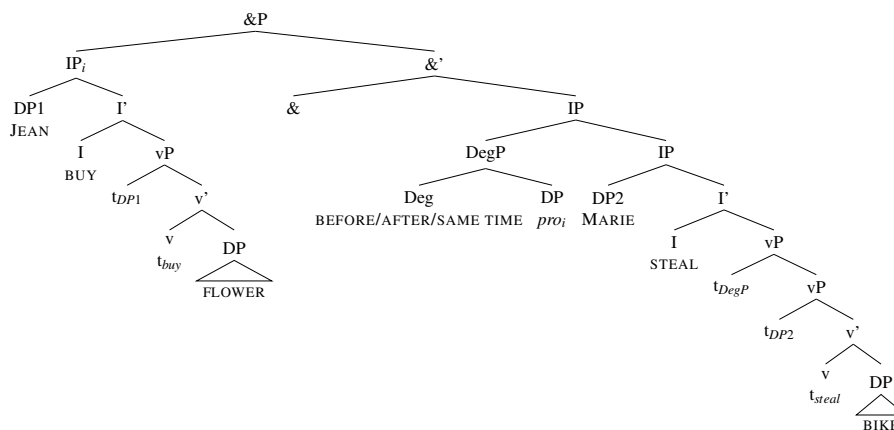

The first conjunct corresponds to the inflectional phrase (IP) lying in the specifier position of the coordinate phrase (&P) while the second conjunct is its complement. LSF temporal markers are mapped along a timeline within the signing space (timeline 1 in [Figure 1](#)). Preliminary observations show that the amplitude of the movement of the signs AFTER and BEFORE can be iconically modulated as degrees along the timeline.<sup>14</sup> Their LIS counterparts display the same properties; hence we capitalize on Aristodemo (2017) by analyzing them as comparative elements, as indicated by the DegP within the second conjunct in the structure.<sup>15</sup>

The anaphoric pronoun *pro* within the complement position of DegP refers to the time established in the first clause, as illustrated by the shared indices. The pronoun is morphologically bound to the adverbial, it is the first locus (the starting point) marked by the adverb itself. The meaning triggered by the DegP is comparable to the meaning triggered by the English expression ‘after that (moment)’. A strong argument supporting the presence of *pro* comes from the interpretation obtained when the temporal adverb is in the first position (recall the inversion and the isolation tests). In these cases, the temporal adverb has to mean ‘after now’. In other words, the temporal markers in LSF take the time reference established before their production as the comparative point for their time reference.

<sup>14</sup> SAME TIME does not display the iconic properties observed for the other two temporal markers. However, since it appears in the same syntactic environment as them we propose a unified analysis.

<sup>15</sup> It is worth noting that the degree phrase only aims at capturing the inherent semantic nature of temporal markers, but substituting it with an adverbial phrase would not affect the general syntactic analysis.



## 5 TYPOLOGICAL REMARKS

Our research shows that LSF and LIS do not belong to the same typological class. While at first look, LIS and LSF temporal constructions seem to differ only in their word order (cf. (43)–(44)), once we take into account the spatialization and the set of non-manual markers, the distinction between the two languages becomes clearer. In LIS, there is neither shoulder/body shift, nor head turn, and the sentence is mainly signed in the neutral space.<sup>16</sup> Moreover, the first clause is signed with the eyebrows raised, which is a typical marker of subordination in this language. This is not the case for LSF which adopts the standard marking of coordination by signing the two clauses on the two opposite sides of the signing space (see [Figure 5](#)).



**Figure 5** Comparison of non-manual markers for *after*-clauses in LIS and LSF.

(43) LIS  

$$[_{sub} \overbrace{\text{GIOVANNI FLOWER BUY}}^{re} \text{AFTER}] \text{MARIA VASE BUY}$$
 ‘Gianni will buy flowers after which Maria will buy a vase.’

(44) LSF  

$$[_{left} \text{JEAN BUY FLOWER}] \overbrace{\text{AFTER}}^{re} [_{right} \text{MARIE BUY VASE}]$$
 ‘Jean will buy flowers and after that Marie will buy a vase.’

Regarding the manual signs, the two languages display other differences. While LIS allows a negative element and the presence of a relative marker, LSF does not. These observations are additional indications that LIS and LSF differ in their syntactic structure.

However, to attain the final conclusion, a more sophisticated investigation was needed. Observing the outcomes of several tests, namely isolation, inversion and extraction, the differences became striking: LIS and LSF display two separate syntactic structures (see [Table 5](#)).

	INVERSION	ISOLATION	WH-EXTRACTION		
			SYMMETRIC	ASYMMETRIC	
Juxtaposition	#	✓	X	X	
Coordination	Change meaning	X	✓ (ATB)	X	
Subordination	✓	X	✓	Sub. clause	
				Main clause	
				X	✓
<b>LIS</b>	X	X	✓	X	✓
<b>LSF</b>	Change meaning	?	✓ (ATB)	X	

**Table 5** Summary of LIS and LSF data

<sup>16</sup> Note that this feature does not entail that every sign should be realized in the center of the signing space. When the sentence contains an agreeing verb, as is the case of *buy* in (44), the verb still displays its directionality through shoulder shift and possibly the use of space.

Through this fine-grained investigation, we have shown that sign languages can display at least two of the typological categories attested in spoken languages' temporal clauses. LIS temporal constructions are mainly conveyed through a subordinate clause akin to relativization just like Swahili, while in LSF signers prefer expressing them using a coordinated structure. Regarding the presence of negation in *before*-clauses, it is interesting to remark that in sign languages we observe the same kind of distinction found in spoken languages. While in LIS the negative marker is obligatory, this is not the case for LSF.<sup>17</sup>

Along the same line, the results of our study confirm that syntactic diagnostics used to investigate spoken languages can also be applied to sign languages, but with great caution. Indeed, as the research on sign languages grows, modality-specific properties come to light. For example, unlike spoken languages, subordinate clauses in sign languages tend to display a fixed order. Indeed, Wilbur (2016) observes that ASL adverbial clauses, including temporal clauses (cf. 45), usually precede the main clause, as in LIS.

(45) ASL

BELL RING [  $\overbrace{\hspace{1.5cm}}^{hn++}$  ], MARY LEAVE<sup>18</sup>  
 'Mary left when the bell rang.'

This is also the case for other types of subordinate structures such as relative clauses in LIS (Donati & Branchini 2009), German Sign Language (Pfau & Steinbach 2005) or Hong-Kong Sign Language (Tang & Lau 2012). Another example of a typological variation between spoken and signed languages concerns how functional words are expressed. These elements are conveyed through non-manual marking or spatialization in the visual modality, while they are often lexicalized in spoken languages (Baker & Padden 1978). Our work has shown that even though some properties can be modality specific, comparative studies between sign and spoken languages are still relevant since both modalities display similar typological variation.

## 6 CONCLUSION

In this paper, we investigated the syntax of temporal constructions in French Sign Language, concluding that they involve asymmetric coordination. Evidence for this analysis comes from morpho-phonological and syntactic properties. We observed that temporal constructions in LSF display the same spatialization properties found in coordinated structures, that inversion of the two clauses provokes a change of meaning and that *wh*-extraction is only possible across-the-board. Although LIS and LSF are historically related and despite their *prima facie* similarities, our in-depth and detailed syntactic investigation reveals that the syntactic structure used in LSF is different from the one used in LIS (coordination vs. subordination). These results show that temporal constructions in the visual modality exploit at least two out of the three typological categories available in spoken languages. To see if the same range of variations is attested across modalities, it is necessary to extend the research of temporal clauses to other sign languages, including historically unrelated ones.

## ABBREVIATIONS

2 = second person, 3 = third person, &P = coordinate phrase, ASL = American Sign Language, ASP = aspect, ATB = across-the-board, CP = complementizer phrase, DegP = degree phrase, DP = determiner phrase, F = feminine, hn = head nod, IP = inflexional phrase, LIS = Italian Sign Language, LSF = French Sign Language, NEG = negation, NMM = non-manual markers, NPIs = negative polarity items, PL = plural, POSS = possessive, PST.PTCP = past participle, PRS = present, P = patient, re = raised eyebrows, REL = relative, SBJV = subjunctive, SG = singular, [<sub>sub</sub>] = subordinate clause, SVO = subject-verb-object, VP = verb phrase.

<sup>17</sup> The presence of NPIs has not yet been studied in LSF, therefore, a deeper investigation is needed to check whether LSF behaves like English in allowing NPIs in *before*-clauses.

<sup>18</sup> In (45), *hn++* indicates the presence of a strong head nod.

We are grateful to Valérie Jendoubi, Thomas Lévêque, and Laurène Loctin for their contribution as LSF consultants. This work also benefited from discussion with Caterina Donati and Carlo Geraci, and audiences at *TISLR 13*, *SLL 2018*, and *ICFL-8*.

## FUNDING INFORMATION

This research was supported by the SIGN-HUB project (European Union's Horizon 2020 research and innovation program, Grant Agreement N. 693349). Research was also conducted at Institut d'Études Cognitives (ENS), which is supported by grants ANR-17-EURE-0017 FrontCog and ANR-10-IDEX-0001-02 PSL.

## COMPETING INTERESTS

The authors have no competing interests to declare.

## AUTHOR AFFILIATIONS

**Valentina Aristodemo**  [orcid.org/0000-0003-1667-7772](https://orcid.org/0000-0003-1667-7772)

LLF, Université de Paris, 8 rue Albert Einstein, 75013, Paris, FR

**Charlotte Hauser**  [orcid.org/0000-0001-5444-3446](https://orcid.org/0000-0001-5444-3446)

LLF, Université de Paris Institut Jean Nicod, (CNRS, EHESS, ENS), 8 rue Albert Einstein, 75013, Paris, FR

## REFERENCES

- Aarons, Debra. 1994. *Aspects of the syntax of American Sign Language*. Boston, BU: Boston University dissertation MA thesis.
- Aristodemo, Valentina. 2017. *Gradable constructions in Italian Sign Language*. Paris, France: EHESS dissertation.
- Baker, Charlotte & Carol Padden. 1978. Focusing on the nonmanual components of American Sign Language. In Patricia Siple (ed.), *Understanding Language Through Sign Language Research*, 27–58. New York: Academic Press.
- Barattieri, Chiara. 2006. *La costruzione ipotetica nella Lingua dei Segni Italiana*. Siena: Università degli studi di Siena MA thesis.
- Bhatt, Rajesh & Roumyana Pancheva. 2007. Conditionals. In Martin Everaert & Henk van Riemsdijk (eds.), *The Wiley Blackwell Companion to Syntax, Second Edition*, 1–48. John Wiley & Sons, Ltd. DOI: <https://doi.org/10.1002/9781118358733.wbsyncom119>
- Brennan, Mary. 1983. Marking time in British Sign Language. In Jim Kyle & Bencie Woll (eds.), *Language in sign: An international perspective on sign language*, 10–31. London: Croom Helm.
- Buechel, Eugene. 1939. *A grammar of Lakota: The Language of the Teton Sioux Indians*. Saint Francis, South Dakota: Rosebud Educational Society.
- Cantin, Yann. 2016. Des origines du noétomalalien français, perspectives historiques. *Glottopol. Revue de sociolinguistique en ligne* 27. 8–17. <https://halemse.ccsd.cnrs.fr/emse-01375969>.
- Culicover, Peter & Ray Jackendoff. 1997. Semantic subordination despite syntactic coordination. *Linguistic Inquiry* 4(28). 195–217. DOI: <https://doi.org/10.1093/acprof:oso/9780199271092.003.0013>
- Del Prete, Fabio. 2008. A non-uniform semantic analysis of the Italian temporal connectives *prima* and *dopo*. *Natural Language Semantics* 16(2). 157–203. DOI: <https://doi.org/10.1007/s11050-008-9030-6>
- De Vries, Mark. 2008. Asymmetric merge and parataxis. *The Canadian Journal of Linguistics/La revue canadienne de linguistique* 53. 355–385. DOI: <https://doi.org/10.1353/cjl.0.0017>
- Donati, Caterina & Chiara Branchini. 2009. Relatively different: Italian Sign Language relative clauses in a typological perspective. In Anió Lipták (ed.), *Correlatives cross-linguistically*, 157–191. Amsterdam: John Benjamins. DOI: <https://doi.org/10.1075/lfab.1.07bra>
- Engberg-Pedersen, Elisabeth. 1993. *Space in danish sign language: The semantics and morphosyntax of the use of space in a visual language*. Hamburg: SIGNUM-Press.
- Geraci, Carlo. 2017. Description of French Sign Language phenomena. *Report of the Sign-Hub project (Deliverable 2.3)*, 7–12.
- Grice, Paul. 1975. Logic and conversation, syntax and semantics. *Speech Acts* 3. 41–58. DOI: [https://doi.org/10.1163/9789004368811\\_003](https://doi.org/10.1163/9789004368811_003)
- Hauser, Charlotte. 2016. *Relative clauses in LSF. Typology and analysis*. Paris: École des hautes études en sciences sociales MA thesis.
- Hauser, Charlotte & Carlo Geraci. 2017. Relativization strategies in LSF, some preliminary results.

- Proceedings of the FEAST 2017 conference* 1. 16–26.
- Johnston, Trevor. 1991. Spatial syntax and spatial semantics in the inflection of signs for the marking of person and location in Auslan. *International Journal of Sign Linguistics* 2(3). 29–62.
- Pfau, Roland & Markus Steinbach. 2005. Relative clauses in German Sign Language: Extraposition and reconstruction. In Leah Bateman & Cherlon Ussery (eds.), *Proceeding of the north east linguistic society (NELS 35)*, vol. 2. 507–521. Amherst, MA: GLSA.
- Pfau, Roland, Markus Steinbach & Bencie Woll. 2012. Tense, aspect, and modality. In *Sign language: An international handbook*, 186–204. Berlin, Boston: De Gruyter Mouton. DOI: <https://doi.org/10.1515/9783110261325.186>
- Pizzuto, Elena, Emanuela Cameracanna, Serena Corazza & Virginia Volterra. 1995. Terms for spatio-temporal relations in Italian Sign Language. In Raffaele Simone (ed.), *Current issues in linguistic theory*, 237–256. Amsterdam: John Benjamins. DOI: <https://doi.org/10.1075/cilt.110>
- Quer, Joseph, Carlo Cecchetto, Caterina Donati, Mariam Kelepir, Roland Pfau & Markus Steinbach. 2017. *The signgram blueprint. a guide to the preparation of comprehensive reference grammars for sign languages*. Berlin, Boston: De Gruyter Mouton. DOI: <https://doi.org/10.1515/9781501511806>
- Ross, John R. 1967. *Constraints on variables in syntax*. Cambridge (MIT): Massachusetts Institute of Technology dissertation.
- Sallandre, Marie-Anne. 2007. Simultaneity in French Sign Language discourse. In Lorraine Leeson & Onno A. Crasborn (eds.), *Simultaneity in Signed Languages: Form and function*, 103–126. Amsterdam: John Benjamins. DOI: <https://doi.org/10.1075/cilt.281.05sal>
- Schlenker, Philippe. 2010. Donkey anaphora in sign language I: E-type vs. dynamic accounts. In Maria Aloni, Harald Bastiaanse, Tikitou de Jager & Katrin Schulz (eds.), *Logic, language and meaning*. 405–415. Berlin, Heidelberg: Springer Berlin Heidelberg. DOI: [https://doi.org/10.1007/978-3-642-14287-1\\_41](https://doi.org/10.1007/978-3-642-14287-1_41)
- Sinte, Aurélie. 2015. *Le temps en langue des signes*, vol. 12. Presses universitaires de Namur.
- Tang, Gladys & Prudence Lau. 2012. Coordination and subordination. In Roland Pfau, Markus Steinbach & Bencie Woll (eds.), *Sign language: An international handbook*, Berlin, Boston: De Gruyter Mouton. DOI: <https://doi.org/10.1515/9783110261325.186>
- Thompson, Sandra A. & Robert E. Longacre. 1985. Adverbial clauses. In Timothy Shopen (ed.), *Language typology and syntactic description: Complex constructions.*, vol. 2, 237300. Cambridge: Cambridge University Press 2nd edn. DOI: <https://doi.org/10.1017/CBO9780511619434.005>
- Traugott, Elizabeth C. 1978. On the expression of spatio-temporal relations in language. In Joseph H. Greenberg (ed.), *Universals of human language*, 369–400. Stanford: Stanford University Press.
- Wilbur, Ronnie. 2016. Preference order in complex sentences with adverbial clauses in American Sign Language. In Annika Herrmann, Roland Pfau & Markus Steinbach (eds.), *A matter of complexity: Subordination in Sign Languages*, 36–64. Berlin, Boston: De Gruyter Mouton. DOI: <https://doi.org/10.1515/9781501503238-004>

TO CITE THIS ARTICLE:

Aristodemo, Valentina and Charlotte Hauser. 2021. Similar but different: investigating temporal constructions in sign language. *Glossa: a journal of general linguistics* 6(1): 2. 1–19. DOI: <https://doi.org/10.5334/gjgl.999>

Submitted: 07 May 2019

Accepted: 01 September 2020

Published: 12 January 2021

COPYRIGHT:

© 2021 The Author(s). This is an open-access article distributed under the terms of the Creative Commons Attribution 4.0 International License (CC-BY 4.0), which permits unrestricted use, distribution, and reproduction in any medium, provided the original author and source are credited. See <http://creativecommons.org/licenses/by/4.0/>.

*Glossa: a journal of general linguistics* is a peer-reviewed open access journal published by Ubiquity Press.