



**HAL**  
open science

## Investigation of critical parameters in power supplies components failure due to electric pulse

L. Curos, T. Dubois, G. Mejezaze, F. Puybaret, B. Plano, J.-M. Vinassa

### ► To cite this version:

L. Curos, T. Dubois, G. Mejezaze, F. Puybaret, B. Plano, et al.. Investigation of critical parameters in power supplies components failure due to electric pulse. *Microelectronics Reliability*, 2020, 114, pp.113936 -. 10.1016/j.microrel.2020.113936 . hal-03493510

**HAL Id: hal-03493510**

**<https://hal.science/hal-03493510v1>**

Submitted on 21 Nov 2022

**HAL** is a multi-disciplinary open access archive for the deposit and dissemination of scientific research documents, whether they are published or not. The documents may come from teaching and research institutions in France or abroad, or from public or private research centers.

L'archive ouverte pluridisciplinaire **HAL**, est destinée au dépôt et à la diffusion de documents scientifiques de niveau recherche, publiés ou non, émanant des établissements d'enseignement et de recherche français ou étrangers, des laboratoires publics ou privés.



Distributed under a Creative Commons Attribution - NonCommercial 4.0 International License

# Investigation of critical parameters in power supplies components failure due to electric pulse

L. Curos<sup>a,b\*</sup>, T. Dubois<sup>b</sup>, G. Mejecaze<sup>a</sup>, F. Puybaret<sup>a</sup>, B. Plano<sup>b</sup>, J.-M. Vinassa<sup>b</sup>

<sup>a</sup> CEA, DAM, CEA – Gramat, F-46500 Gramat, France

<sup>b</sup> Univ. Bordeaux, CNRS, Bordeaux INP, IMS UMR 5218, 351 cours de la libération, F-33400 Talence, France

---

## Abstract

This paper presents an investigation aiming to determine the thresholds that lead to the destruction of power supplies components, such as rectifier bridge and rectifier diode, under differential mode electric pulse injection in the case of High Electromagnetic Pulse (HEMP) scenario. The coupling of HEMP field on long power lines generates high level current and voltage pulse disturbances which can propagate on the power network and flow into power supply input stages such as switch-mode power supplies (SMPS) present on main powered equipment. As a consequence of this injected parasitic, different electrical stresses occur inside the SMPS at electronic components level leading to cascaded destruction events. During a previous study, some internal electrical stresses have been measured and identified as the destruction cause of critical components such as rectifier bridge or rectifier diode. An electrical stress generator made of different capacitor cells is built to reproduce the electric pulses which will be present at the SMPS components terminals during their destruction. Oscilloscope associated to current and differential voltage probes are used to determine the failure moment. The performed tests have shown that rectifier bridge destruction follows a Wunsch and Bell law in current and in power according to the injection pulse duration. Concerning the rectifier diode, its destruction is due to its reverse voltage which has been measured around 135 V. This information will be used, in a future work, to better understand the destruction mechanism observed on complete power supplies and build behavioural models able to predict the destruction of power supplies in the case of HEMP scenario.

---

## 1. Introduction

Electronic devices are more and more widespread in the World. The main parts of critical infrastructures like electric power, water, food, financial, health etc., include in their systems a large number of electronics [1] and so, have become dependent on uninterrupted delivery of electrical power. The threat of ElectroMagnetic Pulse (EMP) attacks is becoming more and more likely to happen. Therefore, studying such a scenario and improving the robustness of infrastructures [2, 3] is important in order that they do not be compromised.

This High ElectroMagnetic Pulse (HEMP) disturbance [4], several kilovolt/meter amplitudes and few hundreds of nanoseconds duration, can couple to an electrical distribution network. Then, interference can propagate to the different electronic devices plugged to the grid as Switch-Mode Power Supplies (SMPS). These SMPS are the first elements that can be functionally disturbed and even destroyed by a high current pulse as it has been shown in [5] or in [6], even if in this last study the whole computer, including a SMPS is tested.

Studying and understanding high current pulse effects on SMPS are revealed crucial. However,

performing such experimentations is quite difficult. Indeed, making measurements in an extreme electromagnetic environment is complex and the source to generate specific interferences is expensive [7]. One of the solutions is to use simulation tools to simulate the propagation of the high-level current pulse and the destruction mechanisms of the different electronic components of the studied system.

To develop the susceptibility model, it is necessary to build a first electrical model of the tested system, in our case, a SMPS [8]. The first step to build such a model is to understand in detail the SMPS destruction. This work has been performed and presented in a previous paper [9] where a current injection system named PIC, described and modeled in [7], able to reproduce high current pulse on power lines, has been used to test SMPS devices. As specified in [7], the shape of the current pulse injected in the SMPS is determined by considering the radiated HEMP standard IEC (High – Amplitude Electromagnetic Pulse – IEC 61000-2-9). In fact, from the incident field described in this standard, the relevant current shape conducted through equipment connected on the main is calculated using our own coupling code. Then, this shape can be reproduced by PIC during injection

---

\* Corresponding author. laurine.curos@u-bordeaux.fr  
Tel: +33 (0) 56 510 5325

tests on electronic equipment. The results of paper [9] associated to currents and voltages measurements at some specific nodes of the SMPS during high current injection in differential mode (DM) have allowed to determine and explain the chronology of the different components destruction leading to the failure of the whole SMPS. It has been shown that whatever the injection mode, the same components were destroyed. There is no specific destruction related to one injection mode. Therefore, in a first approach, due to the fact that differential mode injection mechanisms are easier to understand than in common mode, the SMPS destruction analysis has been performed considering a differential mode disturbance. Moreover, physical analyses have been undertaken allowing to understand the physical mechanism at the origin of the destruction of each component. In order to continue this research project and so the construction of the model, it is required to determine the destruction threshold of each concerned SMPS components. Of course, one important question that has to be answered is what kind of thresholds have to be considered: current, voltage, power, energy levels, ...?

Based on these previous studies, the aim of this paper is to focus on the determination of the destruction levels of two components of the SMPS, which are the rectifier bridge and the rectifier diode.

The paper is composed of four sections. Section II describes the global approach used in this work. In section III, the electrical stress generators used to inject electric pulse on unit component are described. In section IV, destroyed components analyses and understandings are proposed. This section is also dedicated to X-rays analyses performed on rectifier bridges and Section V is dedicated to conclusion.

## 2. Review of previous studies

After topologies and components studies, a representative SMPS of a majority of mainstream power supplies has been designed.

In order to inject a differential mode high current pulse representing the current that could propagate to the SMPS during a HEMP scenario, a generator named PIC presented in detail in [7] has been used. This generator is able to generate a transient current of several hundreds of ampere.

Finally, to understand the failure mechanisms of the SMPS and the chronology of destructions [9], some currents and voltages have been measured at different nodes using current and voltage probes associated to an oscilloscope at the moment of the destruction. Fig. 1 gives the electrical schematic of the studied SMPS as well as some current and voltage waveform examples at the time of the "strike". The main components that are usually destroyed during electric pulse injection are:

- the rectifier bridge in the rectifier part which is destroyed (two diodes of a same diagonal) due to high forward current (several hundreds of amperes) during several milliseconds duration. This high current is due to several previous destructions in short-circuit in the power supply.
- the PWM controller and the diode used as rectifier diode on the auxiliary power supply. This diode is destroyed due to a too high reverse voltage involving a high reverse current (several tens of amperes) during several microseconds duration after avalanche phenomenon.
- the MOSFET and its associated resistors.

Most of these components' destructions on SMPS are not only due to the injected current pulse but they are the consequence of other components failures.

More information and results about this first investigation are available in [9].

Based on these observations and in order to build a model of the SMPS destruction, the next step of the study is to understand the failure of each destroyed components and determine the parameters that are preponderant in the component failures (high current, high voltage, pulse width, energy, etc.).

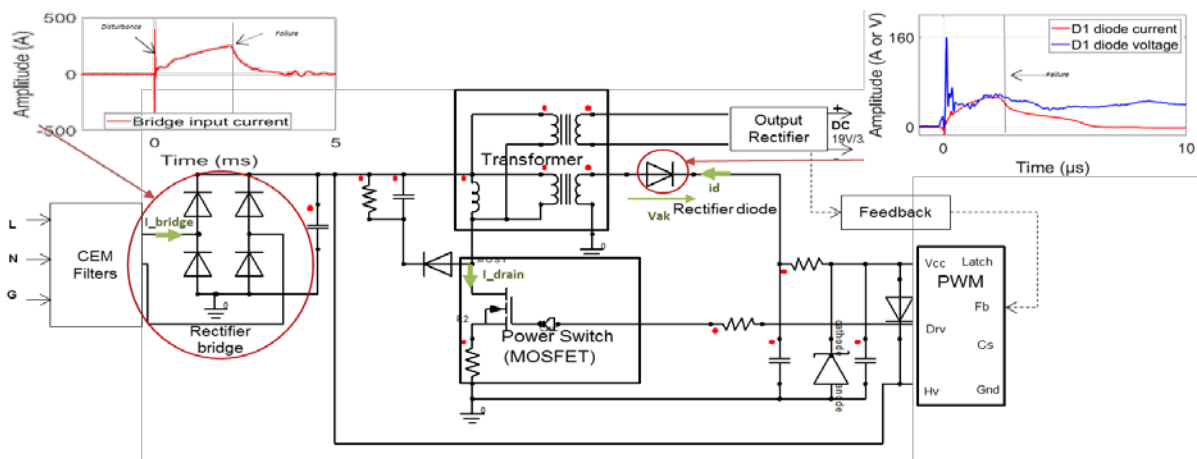

Fig. 1. Electronic schematic of the SMPS.

To reproduce measured current / voltage stress observed on SMPS destroyed component and to understand what kind of parameter is preponderant in component failures a destruction setup has been developed to perform tests, on single components.

### 3. Unitary tests setup

This setup allows to reproduce globally the stress waveforms that have been observed at terminals of the different SMPS components during the electric pulse injection. Tab. 1 summarizes the ranges of the different parameters of the electric stress that can be set.

Tab. 1. Parameters range of the electric pulse.

Parameter	Current	Voltage	Rise time	Width
Min			$\sim 1 \mu\text{s}$	$1 \mu\text{s}$
Max	Higher than 200 A	Higher than 200 V		Higher than 10 ms

Based on the known concept of capacitor discharge [10, 11], the generator, presented in Fig. 2(a), is composed by capacitor cells, a switch, and a DC power supply. This “ $V_{DC}$ ” power supply charges up capacitor cells “ $C_{DC}$ ” to a chosen voltage.

The stored energy in the capacitor is then used to perform the injection pulse when the switch turns on. The current flowing through the device under test (DUT) is measured by a Tektronix TCP404 current probe. A Tektronix differential probe is used to measure the voltage at the terminals of the DUT.

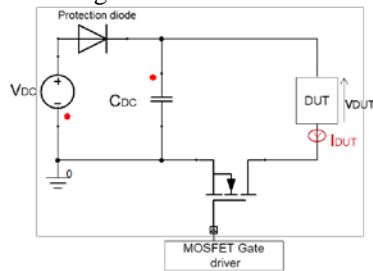

(a)

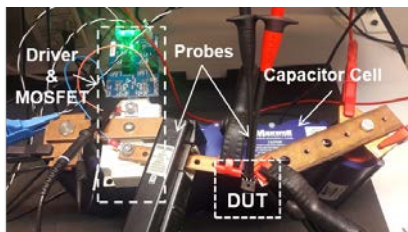

(b)

Fig. 2. Electrical stress generator (a) simplified schematic, (b) photo.

In the concept of capacitor discharge, the rise time of the generator electric pulse is mainly set by the parasitic inductances of the injection system. This is why a particular attention has been dedicated to the assembly connections of the pulse injection system.

To have a fast rise time, a SIC power MOSFET is used as switch associated to a specific driver (CAS300M12BM2). This MOSFET gate driver is used to define the pulse sequence, the pulse duration, etc. A protection diode is also connected at the output of the DC power supply.

In order to obtain the current pulse amplitude, the voltage at the component terminals and the right pulse duration can be adjusted according to Tab. 1.

Consequently, two different configurations of the injection system have been built using two different kinds of capacitor cells. For configuration 1, three capacitors of  $300 V_{DC} / 180 \mu\text{F}$  in parallel are used allowing to reduce the serial resistance (ESR) of the capacitor. This first generator configuration can be used to set a voltage until 300 V at the DUT terminals and permits to limit the voltage drop for short current (higher than 200 A) pulse durations ( $\sim \mu\text{s}$ ). For configuration 2, one  $16 V / 58 F$  supercapacitor is used. This high capacitor value permits to generate high current pulses during several milliseconds with low voltage drop at the DUT terminals. According to the tested component failure mode, one of these two configurations is chosen to reproduce the electrical stress that has been observed at component terminals during its destruction.

### 4. Components analyses and destruction understanding

The two component references studied in this paper are the UD4KB80 rectifier bridge and the MMSD914T1G rectifier diode. To determine properly the parameter that characterizes the destruction threshold of these components, several samples of each reference have been tested. A gradual increasing of the pulse duration has been performed on several samples until component failure. For each pulse step performed, measurements have been carried out allowing to precisely determine the voltage and current levels as well as the exact time of the destruction. Experimentations on components described in this section have been performed without heatsink and in ambient temperature conditions

#### 4.1. UD4KB80 rectifier bridges

According to [9], the destruction of the rectifier bridge used in the studied SMPS is the consequence of other components failures. In fact, due to different short-circuited components inside the SMPS, the input current flowing through the rectifier bridge increases strongly (up to some hundreds of amperes) during few milliseconds, leading to its destruction.

The tested rectifier bridge corresponds to one of the most used rectifier bridges in commercial flyback power supplies. To generate an electric pulse similar to the one measured during the SMPS destruction, the electrical stress generator is set in configuration 2.

The supercapacitor is charged to 8, 10, 12 and 14 V.

For each level, the injected current pulse width is increased step by step to get the threshold time for which the component failure appears. In order to confirm these thresholds this procedure has been performed on at least five samples per voltage level. Regarding the experimental setup, presented in Fig. 3(a), the current pulse is injected on the rectifier bridge between pin 3 and 2 while pin 1 and pin 4 are connected together to force the conduction of a single diagonal. Fig. 3(b) shows an example of the injected current (named “Forward current”), the voltage between pin 3 and 2 (named “Voltage”) and the gate driver voltage leading to the rectifier bridge destruction. The global amplitude shape and duration time of the injected stress correlate with the measured disturbance on SMPS presented in Fig. 1.

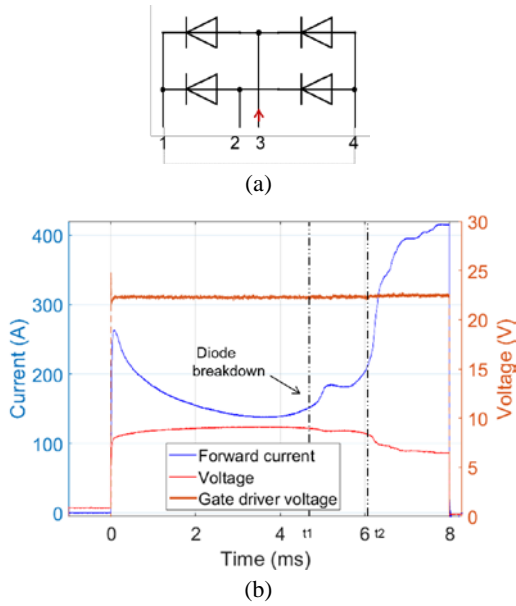

Fig. 3 (a) Configuration of the rectifier bridge for the test, (b) Current and voltage measured during the destruction of the UD4KB80 bridge.

At  $t = 0$ , a current pulse corresponding to an average current of 163 A and a duration of 4.8 ms is injected at the rectifier bridge input. The forward current increases while the voltage between pin 3 and 2 decreases. After  $t = 7$  ms the voltage stops decreasing and remains constant. At this particular moment  $t = t_1$ , one of the diodes of the diagonal is destroyed in short-circuit. After the first diode destruction, at  $t = t_2$ , the current suddenly increases, due to the second diode destruction also in short-circuit.

Fig. 4 presents the rectifier bridge failure time  $t_1$  as a function of the injected pulse power. All experimental points are considered and can be approximated by time dependence of  $t^{-1/2}$  curve. This dependence is associated with thermal breakdown phenomenon presented by Wunsch and Bell [12] and Tasca *et al.* [13]. Wunsch and Bell described the junction breakdown in p-n diode / transistor by a simple model

dependent on junction parameters. In this model, the pulse power and the failure time are linked by Eq. 1.

$$P = K_p t^{-1/2} \quad (1)$$

The safe operating area of the component is determined below the model equation. According to Fig. 4, the Wunsch and Bell model seems to fit (correlation coefficient  $r^2 = 0.98$ ) the experimental data for  $K_p$  of  $109 \text{ W.s}^{1/2}$ .

In the model developed in [12] and [14],  $K_p$  coefficient is linked to silicon (Si) junction parameters described by Eq. 2:

$$K_p_{UD4KB80} = A_j (\pi K_t \rho C_p)^{1/2} (T_c - T_0), \quad (2)$$

where  $K_t$  is the thermal conductivity,  $\rho$  is the density,  $C_p$  is the specific heat,  $A_j$  is the junction area,  $T_0$  is the ambience temperature and  $T_c$  is considered as the melting temperature of Si.

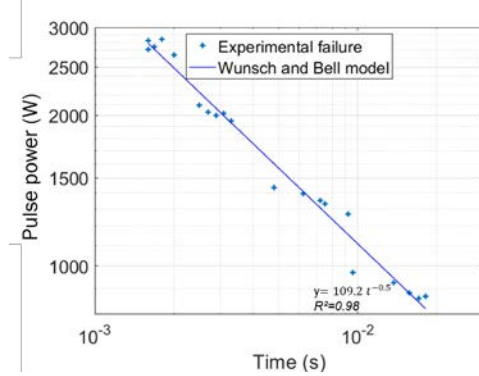

Fig. 4. Destructive power on UD4KB80 bridge.

To observe the junction structure, an X-rays picture of a destroyed rectifier bridge diode has been performed and is presented in Fig. 5. Firstly, a metal connection between the lead frames, in parallel with the chip (light grey part between the 2 dark metal connections) can be observed explaining the short-circuit of the diode. The same phenomenon is observed on the second destroyed diode of the same diagonal. These short-circuits are most probably due to high forward current as mentioned in [13]. Secondly, the X-rays picture has also permitted to estimate the diode junction area that can be used in Eq. 2 to calculate the coefficient  $K_p$  (see Fig. 5). Therefore, considering that the total junction area of the two short-circuited diodes is impacted by the failure,  $K_{p th UD4KB80}$   $103 \text{ W.s}^{1/2}$  can be calculated using Eq. 2 which is really close to the trendline on Fig. 4  $109 \text{ W.s}^{1/2}$ .

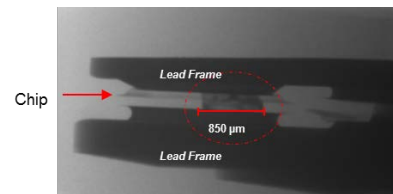

Fig. 5. One short-circuited diode of UD4KB80 bridge.

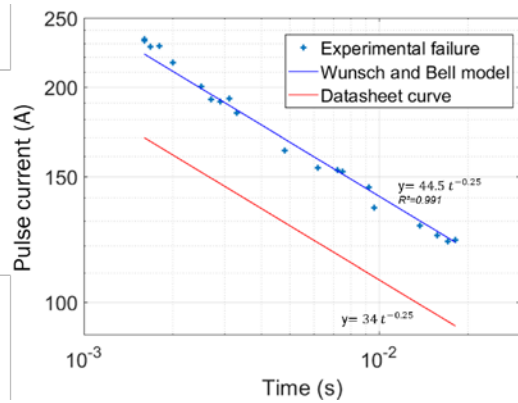

Fig. 6. Destructive current on UD4KB80 bridge.

In the perspective of building a behavioural model from information given by the component datasheet, it is interesting to understand which parameters can be used to estimate the failure thresholds.

Based on the current model dependent on junction parameters of Wunsch and Bell (Eq. 3), the coefficient  $K_i$  can be evaluated using the peak surge forward current from the datasheet.

$$I = K_i t^{-1/4} \quad (3)$$

In fact, the datasheet gives a peak forward current of 135 A for a 60 Hz sinus wave. Therefore, an average current of 95 A during a sinus period of 16.7 ms can be calculated and permits to deduce the  $K_{i \text{ datasheet UD4KB80}}$  coefficient in Eq. 3. Fig. 6 shows the curve obtained using this datasheet information. The gap between the datasheet curve and the experimental curve is around 20%. This difference is probably due to different experimental conditions and manufacturer margins. Additional experiments have been performed using another rectifier bridge reference and the same gap of 20% has also been obtained. Therefore, considering this margin, a prediction of the destruction parameters (current amplitude and pulse duration) might be deduced from the manufacturer datasheet.

#### 4.2. MMSD914TIG rectifier diode

The tested rectifier diode is used in the SMPS to rectify the transformer auxiliary winding voltage to supply the PWM controller (see Fig. 1).

As mentioned in [9], this diode failure is due to a temporary malfunctioning of the PWM controller involving a fast and brief rising voltage (some microseconds' duration) on the diode cathode. The cathode voltage being much higher than the anode one, an avalanche [15] phenomenon occurs leading to the destruction of the component.

To reproduce the diode destruction and determine the failure voltage threshold, electrical stress generator is set to configuration 1. The capacitors cell has been charged at different voltages, and the MOSFET driver forces a 5  $\mu$ s pulse width for each voltage level. Fig. 7

shows an example of reverse current and reverse voltage measured at the diode pins during the avalanche breakdown. The injected stress amplitude and duration are very similar to the measured disturbance at diode terminals on SMPS presented in Fig. 1.

At time  $t = 0$ , the applied reverse voltage of 135 V leads to a reverse current flowing through the component. The current increases suddenly at  $t = t_1$  and exceeds the component limit (at  $t = t_2 = 0.5 \mu$ s), leading to the destruction of the diode in open circuit. This destruction affects the MOSFET's gate voltage. Depending on the destroyed device impedance and generator impedance, the reverse voltage falls rapidly to the capacitor charge voltage level as shown in Fig. 7.

The procedure has been applied on 30 diode samples. For each sample, the measured reverse voltage threshold is noted and has been reported on Fig. 8. It has been observed that diode failure occurs for a reverse voltage level of  $135 \text{ V} \pm 3 \text{ V}$ .

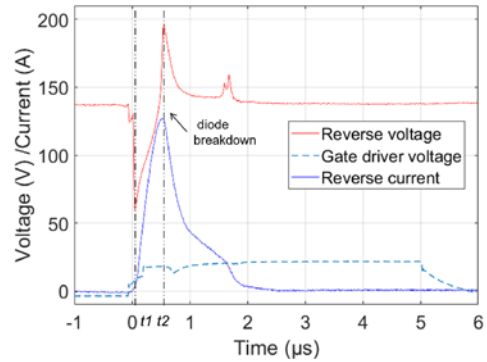

Fig. 7. Measurements during diode reverse breakdown.

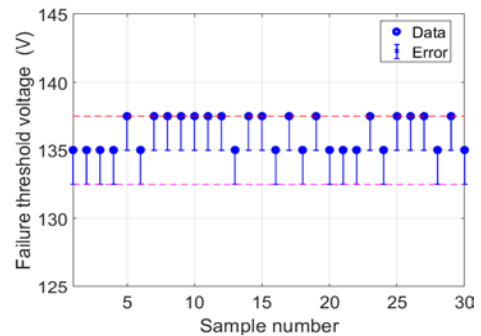

Fig. 8. Failure threshold voltage for each diode sample.

This reverse voltage threshold involves rectifier diode avalanche and a high current flowing through it causing diode breakdown in open circuit. This experimental voltage level is higher than the reverse breakdown voltage of 100 V specified in the datasheet. This difference is also due to the margin specified by the manufacturer in order to guarantee the device maximum ratings.

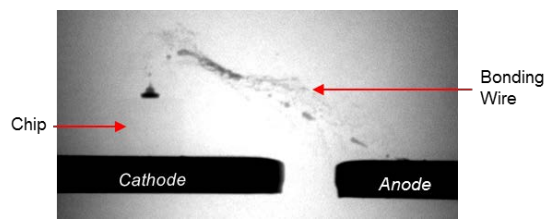

Fig. 9. Diode X-rays analysis.

In addition to experimental results, X-rays analyses have been performed to observe the destroyed diodes. In Fig. 9, the diode bonding wire has been broken, and particles of metal are spread around it. According to experimental results and bibliography [16], a high current density flowing into the diode leads to the destruction of the bonding wire. The diode failure is due to a surge current when avalanche breakdown occurs.

## 5. Conclusion

In this paper, an investigation aiming to determine thresholds that lead to the destruction of power supplies components, such as rectifier bridge and rectifier diode, under electric pulse injection has been presented. To perform this investigation, an electrical stress generator system has been built to carry out tests on single components. These experimentations analyses have permitted to reveal the threshold level leading to the failure of two components of the studied SMPS. Concerning the rectifier bridge, its destruction follows Wunsch and Bell law in current and in power, and depends on pulse duration. Concerning the rectifier diode, the destruction is due to the voltage exceeding the datasheet reverse voltage which has been measured around 135 V.

This destruction threshold of components will be used in future works to build the predictive failure model of SMPS during high current pulse injection.

## Acknowledgements

This study has been carried out with the support of the Direction Générale de l'Armement (DGA) and of the Agence Innovation Défense (AID), both belonging to the French Ministry of the Armed Forces.

## References

- [1] R. Montano, M. Backstrom, D. Mansson and R. Thottappillil, "On the response and immunity of electric power infrastructures against IEMI Current Swedish initiatives," Asia-Pacific Symposium on Electromagnetic Compatibility and International Zurich Symposium on Electromagnetic Compatibility, 2008.
- [2] T. G. Karlsson, G. Unden, and M. Gylmo, "EMP simulation by pulse injection," in Proc. 6th Symp. Tech. Exhibition Electromagn. Compat. (Zurich), March 1985.
- [3] J. S. Foster Jr. et. al., "Report of the Commission to

Assess the Threat to the United States from Electromagnetic Pulse (EMP) Attack," Volume 1: Executive Report, 2004.

- [4] R. Tcheumeleu Tientcheu and D. Pouhè, "Analysis of methods for classification of intentional electromagnetic environments," International Conference on Electromagnetics in Advanced Applications (ICEAA), September 2015.
- [5] N. Kularatna, "Powering systems based on complex ICs and the quality of utility AC source: an end to end approach to protection against transients," Proceedings of Power Quality, October 2005.
- [6] M. Camp and H. Garbe, "Susceptibility of Personal Computer Systems to Fast Transient Electromagnetic Pulses," IEEE Transactions on Electromagnetic Compatibility, vol. 48, pp. 829–833, November 2006.
- [7] G. Mejecaze, L. Curos, T. Dubois, F. Puybaret, and J.-M. Vinassa, "Modelling of a Current Injection Source for Susceptibility Study," IEEE Transactions on Electromagnetic Compatibility, 2019.
- [8] L. Curos, T. Dubois, G. Mejecaze F. Puybaret, and J.-M. Vinassa, "Susceptibility Modelling of SMPS Input Stage Under High Current Pulse Injection," IEEE ICIT 2020.
- [9] G. Mejecaze, T. Dubois, L. Curos, F. Puybaret, and J.-M. Vinassa, "Destruction effects of high pulse electrical stress on power supplies," Microelectronics Reliability, 2019.
- [10] J. Mankowski and M. Kristiansen, "A Review of Short Pulse Generator Technology," IEEE Trans. Plasma Science, vol. 28, no. 1, 2000.
- [11] H. Bluhm, "Pulsed Power Systems Principles and Applications," Springer, Berlin, pp 7-127, 2006.
- [12] D.C Wunsch and R.R Bell, "Determination of Threshold Failure Levels of Semiconductor Diodes and Transistors Due to Pulsed Voltages," IEEE Tran. Nuclear Science, vol. NS-15, no.6, pp 244-259, 1968.
- [13] M. Tasca, "Pulse Power Failure Modes In Semiconductor," IEEE Tran. Nuclear Science vol. 17 pp.364, 1970 Tran. Nuclear Science, vol. NS-15, no.6, pages 244-259, 1968.
- [14] V.M Dwyer, "Thermal failure in Semiconductor Devices," Solid-State Electronics, vol. 33, no. 5, pp. 553-560, 1990
- [15] J. Lutz, M. Domeij, "Dynamic avalanche and reliability of high voltage diodes," Microelectronics Reliability, 2003
- [16] J. Lutz and al., "Semiconductor Power Devices – Physics, Characteristics, Reliability," Springer, 2011.