



**HAL**  
open science

## **ATHENA X-IFU 300 K–50 mK cryochain test results**

T. Prouvé, J.M. Duval, I. Charles, N.Y. Yamasaki, K. Mitsuda, T. Nakagawa,  
K. Shinozaki, C. Tokoku, R. Yamamoto, Y. Minami, et al.

► **To cite this version:**

T. Prouvé, J.M. Duval, I. Charles, N.Y. Yamasaki, K. Mitsuda, et al.. ATHENA X-IFU 300 K–50 mK cryochain test results. *Cryogenics*, 2020, 112, pp.103144 -. 10.1016/j.cryogenics.2020.103144 . hal-03493360

**HAL Id: hal-03493360**

**<https://hal.science/hal-03493360>**

Submitted on 24 Oct 2022

**HAL** is a multi-disciplinary open access archive for the deposit and dissemination of scientific research documents, whether they are published or not. The documents may come from teaching and research institutions in France or abroad, or from public or private research centers.

L'archive ouverte pluridisciplinaire **HAL**, est destinée au dépôt et à la diffusion de documents scientifiques de niveau recherche, publiés ou non, émanant des établissements d'enseignement et de recherche français ou étrangers, des laboratoires publics ou privés.



Distributed under a Creative Commons Attribution - NonCommercial 4.0 International License

# ATHENA X-IFU 300K-50 mK cryochain test results

T. Prouvé<sup>1</sup>, J.M. Duval<sup>1</sup>, I. Charles<sup>1</sup>, N.Y. Yamasaki<sup>2</sup>, K. Mitsuda<sup>2</sup>, T. Nakagawa<sup>2</sup>,  
K. Shinozaki<sup>3</sup>, C. Tokoku<sup>2</sup>, R Yamamoto<sup>4</sup>, Y. Minami<sup>5</sup>, M. Le Du<sup>6</sup>, J. Andre<sup>6</sup>, C.  
Daniel<sup>6</sup>, M. Linder<sup>7</sup>

- 1 Univ. Grenoble Alpes, CEA, IRIG, DSBT, F-38000 Grenoble
- 2 ISAS-JAXA, 3-1-1Yoshinodai,Chuo-ku, Sagamihara, Kanagawa 52-5210, Japan
- 3 R&D-JAXA, 2-1-1 Sengen, Tsukuba, Ibaraki, 305-8505, Japan
- 4 AIST, National Institute of Advanced Industrial Science and Technology, 1-1-1, Umezono, Tsukuba, Ibaraki, 305-8560, Japan
- 5 High Energy Accelerator Research Organization (KEK),1-1 Oho, Tsukuba, Ibaraki 305-0801, Japan
- 6 CNES Toulouse, F-31055 Cedex 4
- 7 ESA-ESTEC, Noordwijk, The Netherlands

## Abstract

In the framework of the ESA X-ray mission ATHENA, scheduled for launch in 2030, an ESA Core Technology Program (CTP) was started in 2016 to build a flight like cryostat demonstrator in parallel with the phase A studies of the ATHENA/X-IFU instrument. As part of this CTP, called the Detector Cooling System (DCS), design, manufacturing and test of a cryostat including existing space coolers will be done. In addition to the validation of thermal performance, a Focal Plan Assembly (FPA) demonstrator using Transition Edge Sensors (TES) detector technology will be also integrated and its performance characterized versus the environment provided by the cryostat. This is a unique opportunity to validate many crucial issues of the cryogenic part of such a sensitive instrument.

A dedicated activity within this CTP-DCS is the demonstration of the 300 K-50 mK cooling chain in a Ground System Equipment (GSE) cryostat. The studies are focused on the operation of the space coolers, which is made possible by the use of a ground cooler for cooling cryogenic shields and mechanical supports.

This test program is also the opportunity to validate the operation of the cryochain with respect to various requirements, such as time constant and temperature stabilities. This would bring us valuable inputs to integrate the cryochain in DCS cryostat, X-IFU studies, SPICA and LiteBIRD missions.

This paper is focused on the operation of the full 300 K – 50 mK cryochain. In particular, the recycling options of the sub Kelvin cooler (sorption cooler + an ADR) versus the capability of 4 K and 2 K JT coolers are described. Results on the JT parameters validation campaign are summarized and eventually the results of the coupled test with sub Kelvin cooler will be presented and discussed.

## **300 K - 50 mK cryochain and test set-up**

Several space missions requires detectors to be cooled as low as 50 mK to reach their required sensitivity. A cryogenic chain, comprising several stages can provide such cooling with long life duration, up to 5 to 10 years. Dedicated coolers for each stages of this cryogenic chain have been developed. For such purpose, ESA (European Space Agency) funded Air Liquide and its partners for the development of a 15 K pulse tube providing up to 400 mW of cooling power (ref 13). JAXA (Japanese Exploration Agency) with its industrial partners SHI (Sumitomo Heavy Industry) developed a 4 K JT precooled with a Stirling cooler, already used in several space missions. In addition, it developed a 2K JT, using  $^3\text{He}$ , dedicated to the currently discussed missions. A 50 mK hybrid cooler, using a combination of an adsorption stage and an ADR (Adiabatic Demagnetization Refrigerator) has been developed at CEA and brought to TRL 6 (ref 11,12). To validate the coupling of all these cryocoolers, a dedicated cryostat program has been initiated and is described in this paper. This work is part of a wider demonstration, partly funded by ESA, of an instrument including cryogenic chain and FPA (Focal Plane Assembly) under the name DCS (Detector Cooling System). The DCS program is aimed as a preliminary demonstration for the X-IFU instrument(ref 1,2). Similar cryogenics chain are also planned for the SPICA (ref 6,9) missions.

### **Cryochain**

For the cryogenic chain demonstration, the cryocoolers are coupled together and validated in the so called « cryostat 1 » using ground system equipment (GSE) to cool thermal shields and mechanical supports (ref 3). This cryochain demonstration is a critical milestone also for the SPICA (ref 6) mission with the operation of the SAFARI (ref 11,12) hybrid cooler from CEA coupled to JAXA 4 K and 2 K JT coolers (ref 7,8). A CAD model of the cryochain is depicted in Figure 1. The 4 K JT design is based on ITOMI and SPICA designs (ref 9,16). JAXA has built and tested a 2 K JT which is precooled by a 2 stage Stirling cooler (ref 10). In the frame work of this contract, the Stirling precooler is replaced by a 15 K Pulse tube (ref 13) cooler from Air Liquide which presents higher cooling capacities and could provide better precooling temperature and thus enhance JT performance. An extensive testing campaign of this new 2 K cooler has been carried out but the results are not presented in this paper. Eventually, the hybrid cooler is connected to the JT coolers through dedicated thermal links.

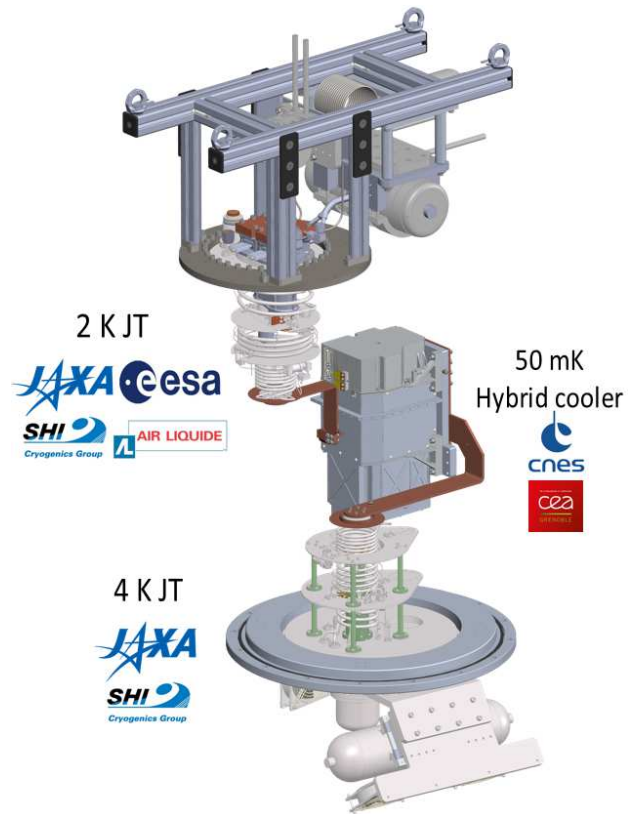

Figure 1: details on the 300 K-50 m K cryochain (agencies & suppliers)

## Test set-up and integration sequences

The design of the test setup, schematically represented on top of the Figure 2, has been described in a previous article (ref 3). The cryochain is integrated into a GSE host cryostat. This cryostat has two actively cooled thermal shields. The outer cryogenic shield at 100 K and the inner cryogenic shield tunable between 5 K and 30 K to evaluate radiative sensitivity of the cryochain low temperature parts. The JT cold tips and the hybrid cooler are mechanically supported by the cryostat. Each stages have light baffles to prevent stray light. The 4 K structure, including the hybrid cooler, cool down time is shorten by using a cooling booster. It is a gas gap heat switch (HS3 on Figure 2) making a thermal coupling between the cryochain and the powerful, 4 K class, GSE cooler.

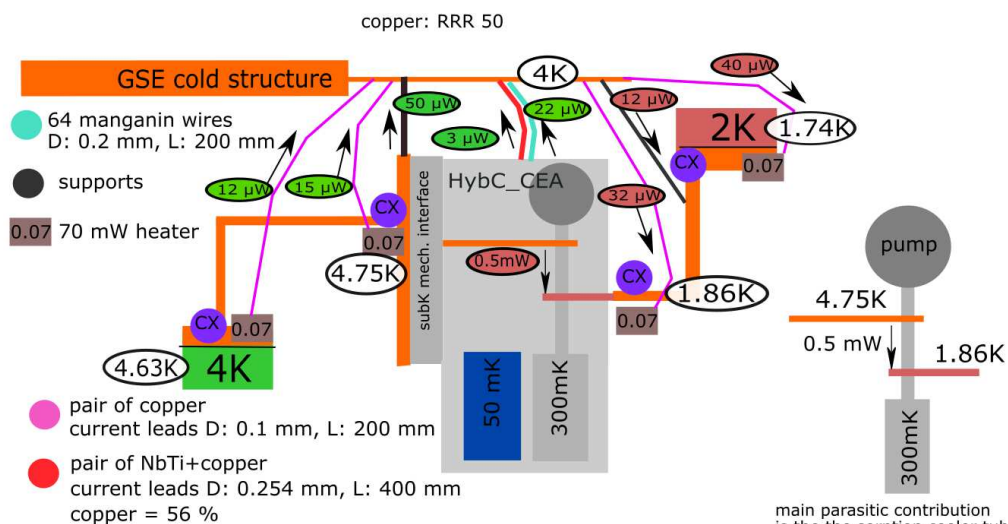
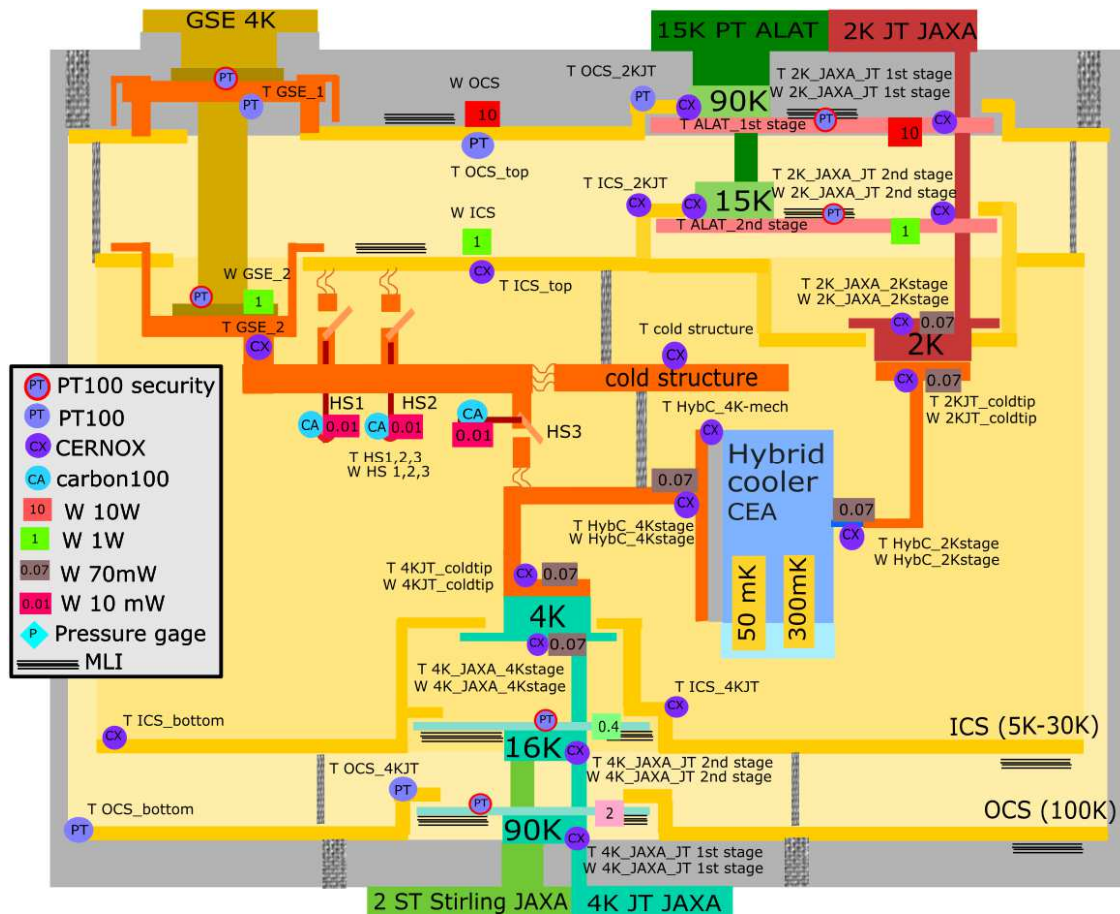

Figure 2: Top: scheme of the cryostat with the housekeeping thermometers and heaters. bottom: parasitic thermal balance of the Hybrid cooler during recycling phase.

The two JT coolers have been integrated and reception test have been made to qualify the cool down procedure, booster device, and good operation of ICS temperature variation without conductive thermal coupling with the JT coolers (ref 3). The JT coolers have then been extensively operated with dedicated tests to find the best parameters in order to recycle the hybrid cooler (ref 4).

The hybrid cooler has been then integrated. Because the hybrid cooler is thermally connected both to the 2 K interface and to the 4 K interface, it makes a thermal coupling between these two stages. This coupling leads to a parasitic heat flow on the 2 K cooler which reaches its maximum during the recycling of the cooler because of the 4 K cooler temperature increase. The various contributions have been evaluated for the recycling phase (see Figure 2) and they account for about 0.5 mW, by far dominated by the sorption cooler internal tubing. The interface temperatures profiles during recycling are presented on the graph of the Figure 10. Due to a decrease of the temperatures after the recycling phase has finished, the parasitic losses become lower as well. Nevertheless, we keep a value of 0.5 mW for the losses in our regulation system.

As shown on the Figure 3, some care have been taken to prevent stray light onto the sub Kelvin cold tips. The housekeeping wiring as well as a cover have been studied to ensure a low parasitic heat losses level at 0.3 K and 0.05 K during operation. On the right picture of the Figure 3 we can see the closed baffle at the top of the hybrid cooler with the housekeeping feedthrough.

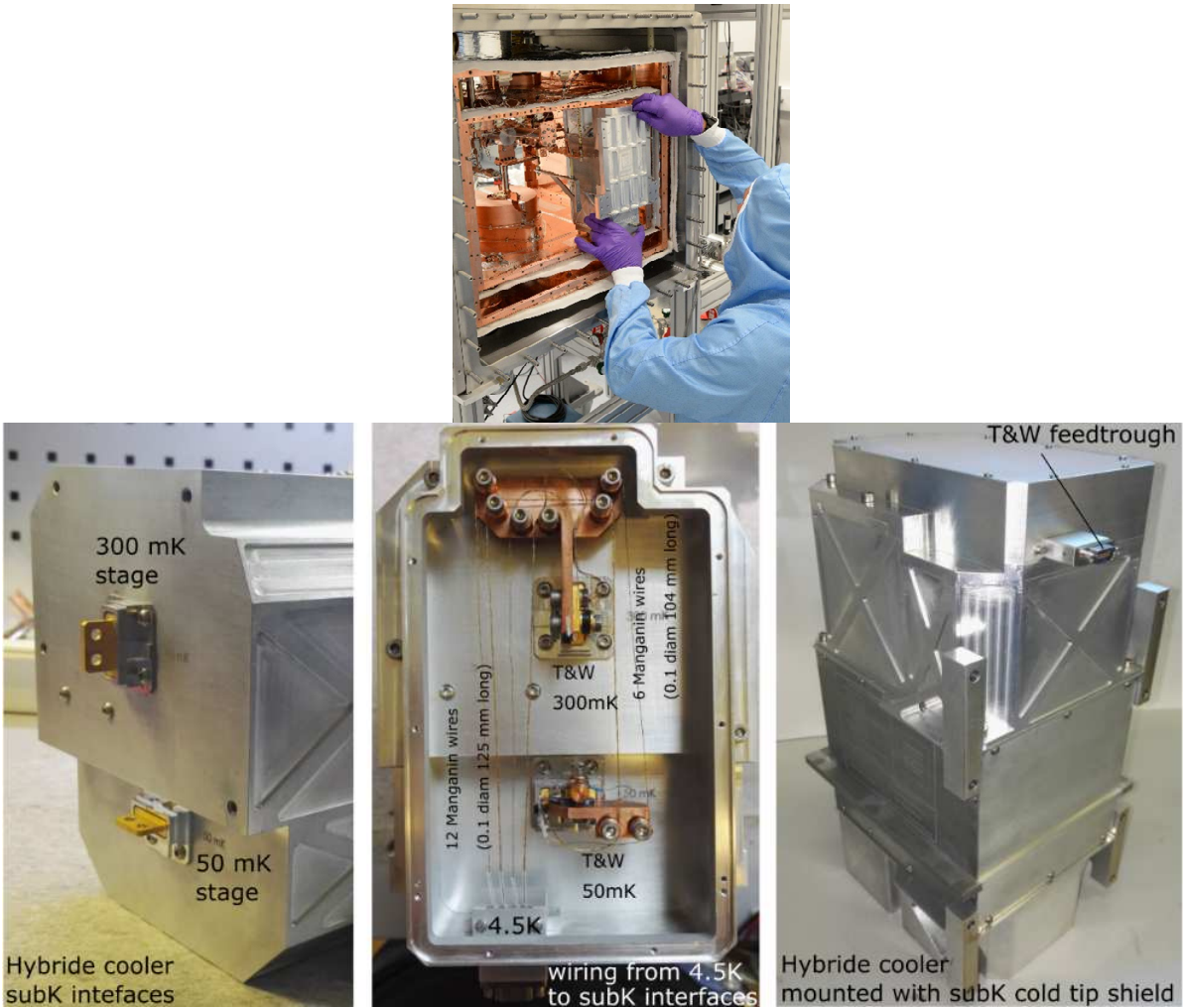

Figure 3: Picture of cooler integration and details of the hybrid cooler sub Kelvin cold tips housekeeping inside the

## Hybrid cooler recycling methods

One of the main particularity of this coupling of coolers is the coupling of coolers providing continuous cooling, such as JT coolers, with the hybrid cooler, which operates intrinsically with a succession of cold phase with “recycling” phase. Moreover, the power dumped to the warm interface of the hybrid cooler (i.e. JT cold exchanger) vary almost as a step function between recycling and cold phase (ref 12 and Figure 4). It is worth noting that at first order, the time of the recycling is inversely proportional to the available power. In other word, recycling the hybrid cooler needs a set energy that have to be dissipated over time.

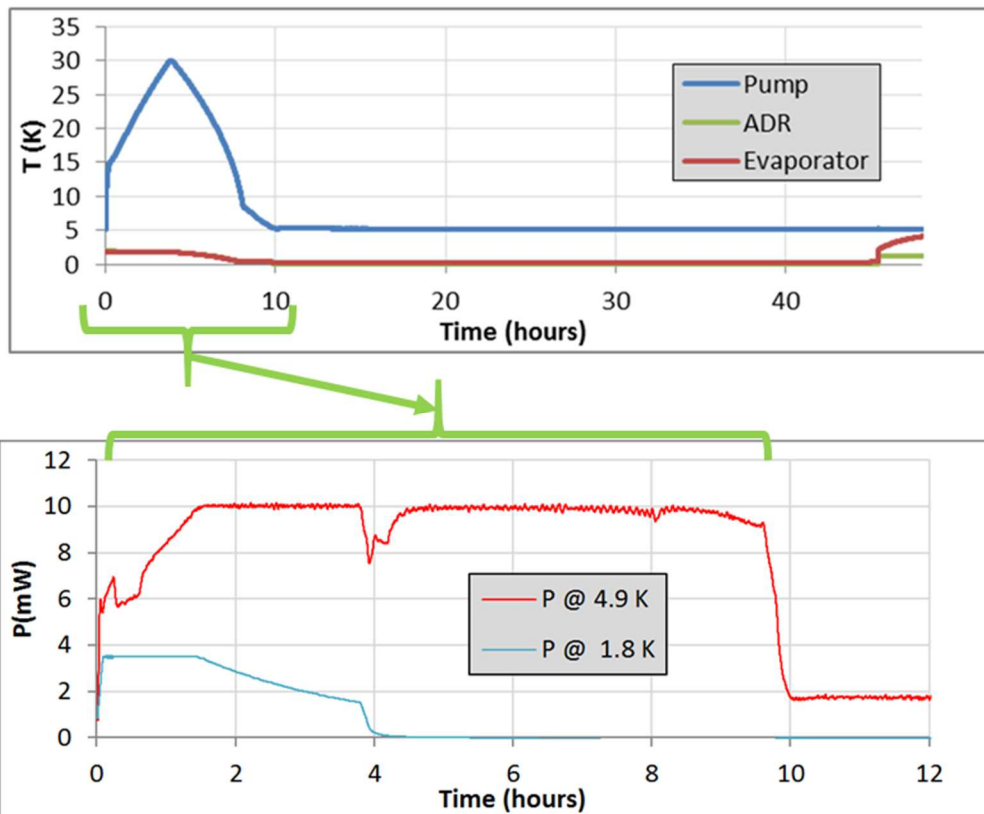

Figure 4: typical recycling plots for the hybrid cooler in lab L4He cryostat and power dissipated in the recycling mode.

The hybrid cooler is using two warm interfaces: one to the 2K JT and one to the 4K JT. To insure that the power dumped to each of the JT interfaces do not overload these coolers, it is important, first to measure the heat flow, and second to control it. The heat flow is measured thanks to the in-situ conductance calibration of the thermal link between the JT interface and the hybrid cooler interface. In our previous developments on the hybrid cooler, the measurement and control of the power dumped to the warm interfaces has been well mastered (ref 11). Based on these experiences, the control of the heat flow has been done in 3 different ways which are described below. For internal reasons, we call these methods respectively 1a, 1b and 3 and keep these names further.

The first method is to limit the power dumped to the JT coolers to a set maximum value. The second method is to limit the temperature of the JT coolers interface to a maximum value. This will lead to a transient higher power load to the JT interface, but will stabilize over time to the same power as the first method. Finally, the third method use a constant temperature interface, with a regulation using a heater on this interface.

<b>Methods</b>	<b>Main Advantages</b>	<b>Main Drawbacks</b>
1a : constant heat flow	Maximum heat flow=> simpler interface discussion	Measurements and control difficult Less thermodynamically efficient (higher power dissipated) Varying JT operating parameters
1b : maximum set temperature	Easier control (one temperature read out) Efficient (quicker)	Varying JT operating parameters
3 : Regulated temperature and power	Constant JT Operation Similar to test cryostat Heat flow well measured => simpler interface discussion	Inefficient thermodynamically

Table 1 : comparison of the 3 control methods

The three methods are compared in Table 1. The method 3 has been extensively used and demonstrated during the qualification of the hybrid cooler (ref 11). It leads to a constant power dumped to the JT, equal to the maximum nominal value. While this last method is not thermodynamically efficient - requiring a constant heat load on the JT interface, including during cold time - it leads to constant operation parameter on the JT, which is an advantage for space qualification. Its validation in this experiment is not required because it replicates exactly a continuous JT operation and the measurement on the hybrid cooler previously done. The advantage on method 1b over 1a is mostly because its control is easier, based only on one thermometer read-out. Another advantage is that it is possible to have a higher heat load during the time of inertia of the JT that can quicken the recycling of the hybrid cooler by several 10% depending on the exact operation conditions.



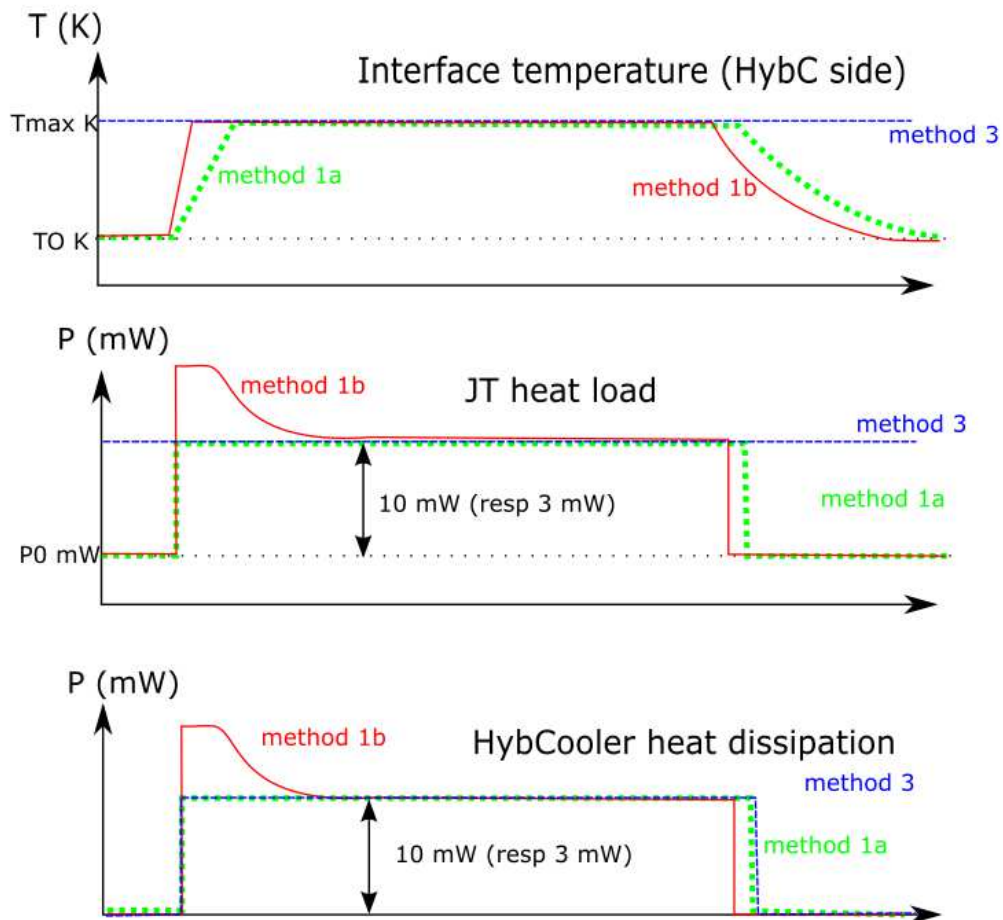

Figure 5: Description of the hybrid cooler recycling methods 1a, 1b and 3

Because the recycling speed is mostly limited by power on the 4K JT (Figure 4), the automated algorithm will be only implemented on this JT. The power on the 2K JT will be limited by the setting of the first part of the cycle (no closed loop regulation).

### Qualification of JT operation against recycling methods option

Prior to make the coupling between the JT coolers and the Hybrid cooler, The JT cold tips were independent and only connected to nonconductive mechanical supports (ref 3,4). At first, the nominal cooling power of the JT has been verified and 2 K cooling power has been measured as function of the 15 K PT precooling temperature (ref 4). Then, the possibility to operate safely despite the quick heat load variations described on the previous chapter had to be assessed. The risk is piston touching, which could occur when the applied power on the cold-tip is reduced which lead to lower temperature and a drop in gas pressure. This risk is higher for higher cooler power or higher piston stroke on the JT compressors.

Therefore, setting the nominal parameters for the JT coolers implies maximizing both the available power and the maximum safe variation of cooling power. This is more difficult for the 2K JT than for the 4K JT. For the former, a large test sequence leads to a JT compressors parameter set giving the possibility to operate between 5.5 mW and 9.5 mW without settings changes. The 4 K JT can deal with large power variations, 10 or 20 mW, with a maximum power of 40 mW.

For DCS and X-IFU the thermal budget of the hybrid cooler is 10 mW to the 4 K JT and 3.5 mW to the 2 K JT. Deducing the 0.5 mW conductive losses from 4 K to 2 K (see Figure 3), the recycling budget at 2 K is equivalent to 3 mW.

The following values give the JT performances after JT compressors tuning.

- 4 K JT settings X-IFU/SPICA 1: 30 mW@4.5K (20mW @ 4.32K)
- 4 K JT settings X\_IFU/SPICA 2: 40 mW@4.62K (30 mW @ 4.32K or 20 mW @ 4.24 K)
- 2 K JT settings X\_IFU: 9.5 mW@ 1.74K (6.5 mW@1.67 K)
- 2 K JT settings LiteBIRD: 7 mW @ 1.74K (3 mW @1.66K)

Once the JT coolers compressors parameters have been set for coupling with the hybrid cooler, method 1a and 1b have been tested by producing heat profiles thanks to heaters. The graphs on the Figure 7 give a view on the power and temperatures profiles for some of the test made with the 4 K JT. In the three cases, the power allocated for the hybrid cooler was 10 mW and was applied using the heater W 4KJT cold-tip. The constant power allocated to the instrument was simulated on JAXA cooler side using W 4K-JAXA\_4Kstage. The time constant of the cold tip temperature evolution is about 1.5 hour with a nominal 10 mW heat load increase for method 1a. For method 1b, we tested an overload peak heat load of 30 mW without seeing any trouble on the JT operation. The overload time frame is around 15 minutes in this case. The advantage previously mentioned of quicker recycling is therefore not so important, but its simplicity remains. Method 1b has been tested with success for the two JT settings of 30 mW and 40 mW maximum power.

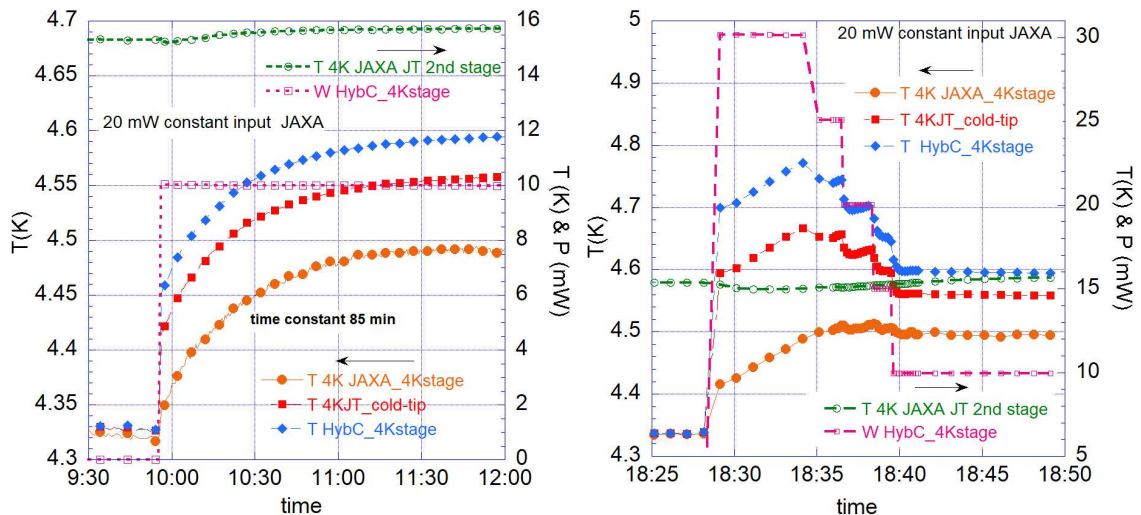

Figure 6: 4K JT time constants. Top: 30 mW @ 4.5K (method 1a (left) and method 1b (right)).

The same test have been performed with the 2 K JT cooler. A constant 6 mW heat load was applied on JAXA side with W 2K\_JAXA\_2Kstage and hybrid cooler simulation was done using W 2KJT\_cold-tip. On the left graph of the Figure 8, only method 1b test results are represented. The test has been performed with an overload peak power of 11.5 mW during 45 minutes and then has been reduced to the nominal maximum power of 9.5 mW.

The temperature of the orifice gives a useful information on the cold tip conditions. In normal operation the orifice temperature remains slightly colder than the col tip itself where heat is applied. When the cold tip is about to dry-out, the orifice temperature increase and becomes warmer than the cold tip. At this point the operation of the JT is not going to last and applied power has to be reduced in order to recover a nominal operation. The orifice temperature is thus a good driver of the capability of the coolers. Another experiment, not presented here, have been done with a 2K JT already operating at its maximum heat load of 9 mW. The temperature increase indicative of JT dry out has been observed only after 9 minutes with 2 mW additional power. The 45 minutes, 2 mW, overload during method 1b and then 9 minutes, 2 mW, overload acceptable, while being already at maximum power, give some margin in the cooler overall power load management.

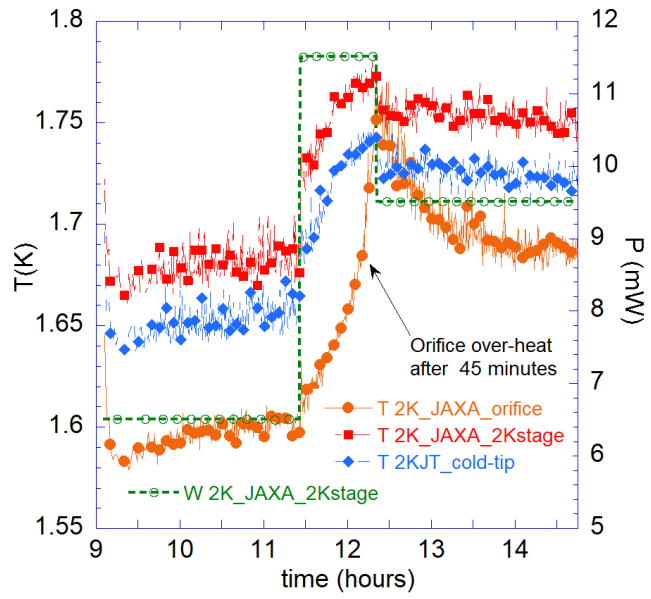

Figure 7: Behavior of the 2K JT, precooled at 15 K, during method 1b simulation

# Coupled test results

## Cool Down

The cryostat and cryochain cool down from room temperature is presented on Figure 9. During the cool down phase, only the GSE pulse tube and the JT precoolers are effectively providing cooling power. JT cold tips are cooled down through by-pass integrated in the JT design and through the GSE cooling booster in cryostat 1 case. The power on the Stirling cooler is gradually increased according to the cold finger cool down and mechanical gap increase. Regarding the 15 K pulse tube, the power is also increased gradually. It takes about two days to cool down the cryochain down to hybrid cooler cycling conditions. In this graph, the cool down booster is turned OFF at 37 hours and the JT are started at 44 hours by closing the by-pass. Two main possible issues have been identified for the cool down of the cryochain. The first one is the possibility to freeze the displacer of the 4 K JT Stirling pre-cooler. The main cause of the cold sticking is assumed to be CO<sub>2</sub> as well as H<sub>2</sub>O. Both gas were detected as the outgas in the coolers (ref 15). To prevent this, the Stirling cooler was started a couple of hours prior to start the GSE cooler. The second possible issue was to plug the JT coolers in by-pass mode by over cooling the JT cold tips. To prevent this, the booster was turned off automatically at 20 K.

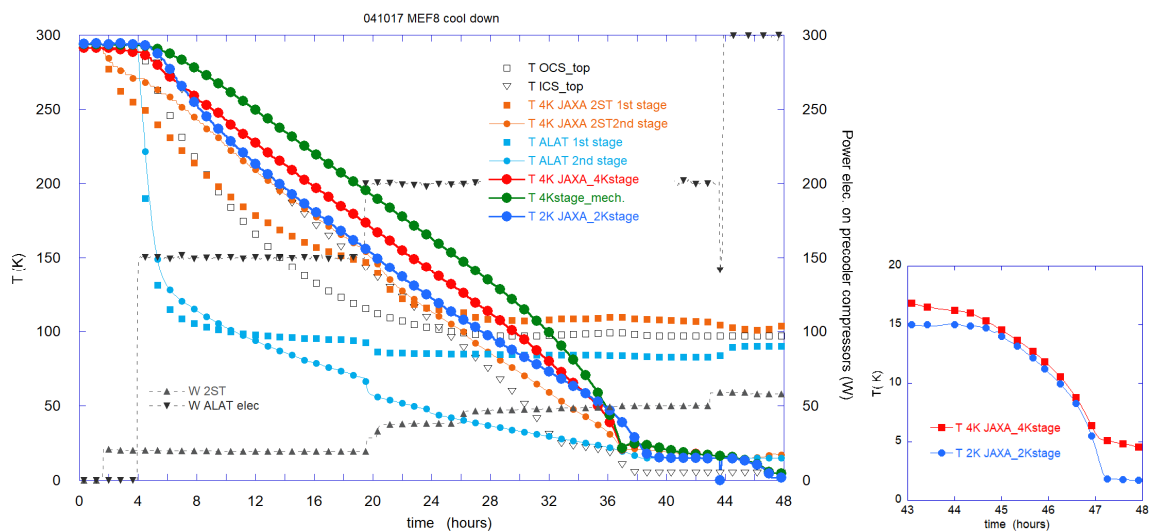

Figure 8: cryostat and cryochain cool down

As shown on the right graph of Figure 9, it takes about 3 hours for the 4 K JT to cool down the hybrid cooler along with the mechanical structure and thermal straps. The hybrid cooler is thermally connected for the most massive part to the 4K JT and for some other components to the 2K JT. Cooling time of the JT coolers after by-pass precooling has been studied by JAXA in the framework of cryostat 1 (ref 5), and calculation of the cool down capacity of the JT coolers has been deduced.

## SubK recycling with METHODS 1A,1B, 3, short and long cycle

With the interface temperature set as previously described, demonstration of 300 mK and 50 mK cooling has been done, operating the hybrid cooler in its nominal operating conditions. For this, the nominal cooling power at 50 mK and 300 mK is respectively  $0.4 \mu\text{W}$  and  $14 \mu\text{W}$ . The operation of the hybrid cooler is well described in ref 11 and is not repeated here.

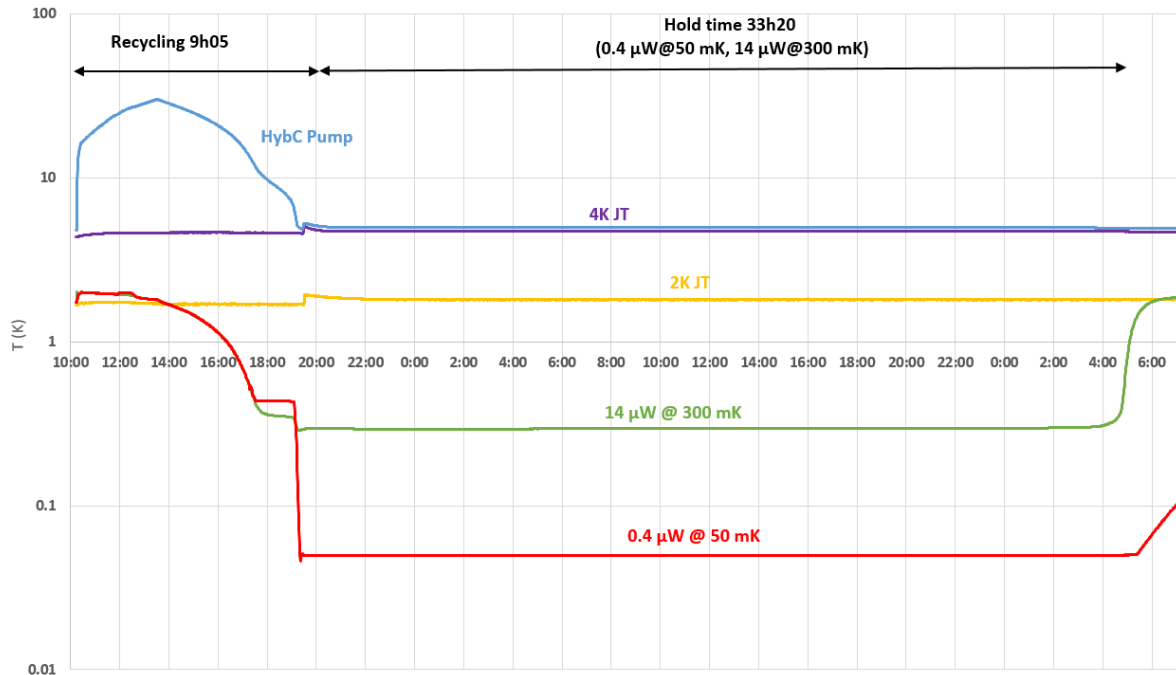

Figure 9: Hybrid cooler recycling and hold time. TBD : enlever date/nom cycle. qualité rajouter les puissances, ...

For this demonstration, the method 1b previously described has been used. A nominal recycling has been performed, leading to a measured hold time of 33h20 with a recycling time of 9h05 which is in line with the past results and prediction. This validates clearly the possible coupling between the JTs and hybrid cooler.

The interface temperatures during the recycling phase is presented on Figure 10, showing the maximum temperature set for the regulation (1.86 K and 4.75 K). This temperature had been obtained by a previous calibration to correspond to the nominal power of recycling (10 mW on the 4 K interface and 3.5 mW on the 2K interface)

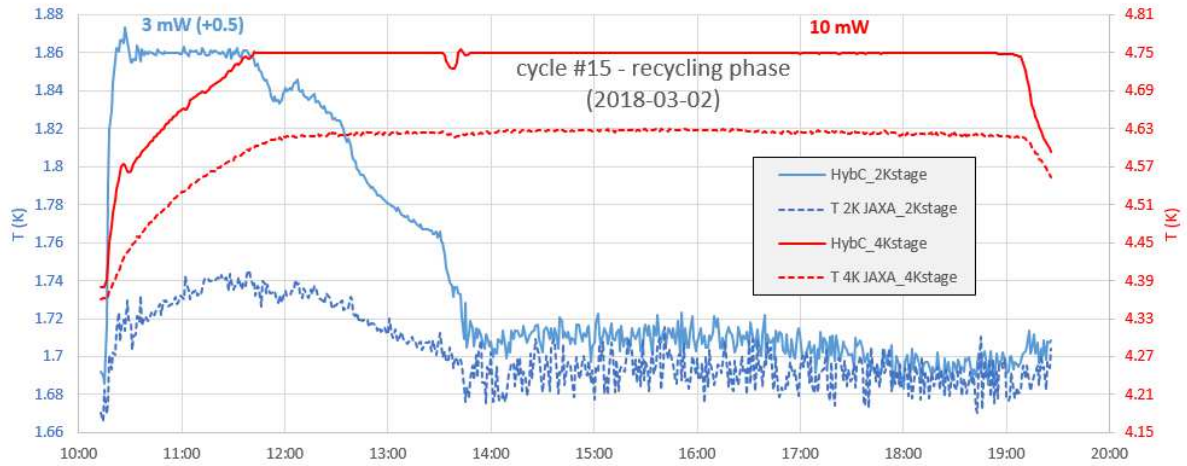

Figure 10 :interface temperature during recycling

To go further and propose alternative operating modes, a shorter cycle has been tested. It has been shown that the hybrid cooler can operate with a recycling time or hold time varying in the same proportions, simply by modifying the recycling parameters (e.g. sorption pump maximum temperature).

For all these measurements, no special attention had been put to the thermal stability values at cold temperature. Typical values, previously measured of 4  $\mu$ K RMS of noise at 50 mK has been measured. This is not a limit as in other development [Duval, 2019], measurements of noise level of 0.4  $\mu$ K RMS had been measured demonstrating that such low numbers could be achieved.

The sensibility to the environment had also been assessed by increasing the shield (ICS) temperature to 30 K. During the radiative test with ICS at 30 K, the objective is to test the light tightness of the cooler but it is known that the sub Kelvin cold tips could not withstand such high radiative power so all parts which temperature is lower than 2K are radiatively shielded by cover. During this test, the performances had not been measurably different than the standard measurements, proving that the hybrid cooler can operate in a 30 K environment with no degradation providing, obviously, that the subkelvin stages are thermally shielded.

### Thermal coupling and operating temperatures

Similar cycles have been tested to represent the environment considered for planned instrument such as SPICA or LiteBIRD. The results not presented here shows that the cooling chain can be adapted to various operating conditions.

Cycle description	2K interface				4K Interface			
	JT side (K)	HybC Side (K)	Power Instrument (mW)	Power sub K (+ intern) (mW)	JT side (K)	HybC side (K)	Power instrument (mW)	Power sub K (+intern) (mW)
X_IFU or SPICA	1.74	1.86	6	3+0.5	4.63	4.75	30	10
LiteBIRD	1.74	1.88	3	3.5+0.5	4.7	4.88	15	15

Table 2 : interface temperatures for typical recycling setups

## **Conclusion and perspective**

A cryostat has been designed and manufactured to test a space compatible cooling chain envisioned for missions such as ATHENA, SPICA or LiteBIRD. After integration and validation of the cryostat operating parameters, the cryochain had been successfully tested with stable 50 mK operation and with performances. The performances (duty cycle) and operating parameters of each coolers had been characterized and recorded and are in line with prediction.

The key to this demonstration is the coupling between JT coolers which are continuous cooler that are very sensitive to operating parameters change with a non-continuous cooler, such as the hybrid cooler.

This cryostat can offer many possibilities to prepare the design of flight cooling chain, including detailed and specific measurements such as parasitic heat load, precooling loads and so forth. Concerning the Athena program, a demonstration model of a flight like cryostat is being designed as part of the ESA CTP Detector Cooling System. This next cryostat will include only space technologies for shield cooling and the cooling chain tested in cryostat 1 program will be used to cool down the 4K and 2K stages as well as the 50 mK focal plan assembly. The knowledge and parameters qualification of this cryochain will ease the operation of this advanced cryostat.

## REFERENCE

1. Barret D. & al , The Athena X-ray Integral Field Unit (X-IFU), Proceedings of SPIE 9905 (2016) 99052F doi:10.1117/12.2232432
- 2 Charles I. & al, Preliminary thermal architecture of the X-IFU instrument dewar Proceedings of SPIE 9905 (2016) 99052J doi: 10.1117/12.2232710
- 3Prouvé T & Al, ATHENA X-IFU 300 K-50 mK cryochain demonstrator cryostat Cryogenics 89 (2018) 85–94, doi:10.1016/j.cryogenics.2017.11.009
- 4 Shinozaki K. & al, Cooling performance of Joule Thomson coolers in 300 K -50 mK cryochain demonstration for ATHENA X-IFU 2019 IOP Conf. Ser.: Mater. Sci. Eng. 502 012069
- 5 Shinosaki K. & al, Cooling capability of JT coolers during the cool-down phase for space science missions, to be published in SCW19 cryogenic edition
- 6Nakagawa T. & al, The next-generation infrared space mission SPICA: project updates, Korean Astronomical Society, 2017, Vol 32, pages 331,335, doi: 10.5303/PKAS.2017.32.1.331
- 7 Sato Y. & al, Development of 1K-class Joule–Thomson cryocooler for next-generation astronomical mission, Cryogenics, Volume 74, March 2016, Pages 47-54 doi: 10.1016/j.cryogenics.2015.10.017
- 8 Narasaki K. & al, Development of 1 K-class mechanical cooler for SPICA, Cryogenics, Volume 44, Issues 6–8, June–August 2004, Pages 375-381, doi:10.1016/j.cryogenics.2004.02.012
- 9 Sugita H. & al, Cryogenic system for the infrared space telescope SPICA, Proc. SPIE 7010, Space Telescopes and Instrumentation 2008: Optical, Infrared, and Millimeter, 701030 (July 12, 2008); doi:10.1117/12.788721
- 10 Shinosaki K. & Al, Developments of 1-4 K Class Space Mechanical Coolers for New Generation Satellite Missions in JAXA In: Miller SD, Ross RG, editors. Cryocooler, vol.16. ICC Press; 2010. p. 1-8.
- 11 Duval, J.-M. & al, “Qualification Campaign of the 50 mK Hybrid Sorption-ADR Cooler for SPICA/SAFARI.” IOP Conference Series: Materials Science and Engineering 101, no. 1 (2015): doi:10.1088/1757-899X/101/1/012010.
- 12 Duband L. & al, “SAFARI Engineering Model 50 mK Cooler.” *Cryogenics* 64 (November 2014): 213–19. doi:10.1016/j.cryogenics.2014.02.008.
- 13 Penneec Y. & al, “Engineering Model of a High Power Low Temperature Pulse Tube Cryocooler for Space Application” *Cryocoolers* 19 (2016): 43–48.
14. Duval JM &al, “Experimental results of ADR cooling tuned for operation at 50 mK or higher temperature”, to be published in *Cryocoolers* 21 (2020)
15. Y.Sato et al., Outgas analysis of mechanical cryocoolers for long lifetime, *Cryogenics* v88 (2017) pp70-77, doi: 10.1016/j.cryogenics.2017.10.001



16. Kanao K &al, Cryogen free cooling of ASTRO-H SXS Helium Dewar from 300 K to 4 K, Volume 88, December 2017, Pages 143-146, doi: 10.1016/j.cryogenics.2017.10.018