



HAL
open science

Robust optimization of an organic Rankine cycle for geothermal application

Aldo Serafino, Benoit Obert, Léa Vergé, Paola Cinnella

► **To cite this version:**

Aldo Serafino, Benoit Obert, Léa Vergé, Paola Cinnella. Robust optimization of an organic Rankine cycle for geothermal application. *Renewable Energy*, 2020, 161, pp.1120 - 1129. <10.1016/j.renene.2020.07.052>. <hal-03491547>

HAL Id: hal-03491547

<https://hal.science/hal-03491547v1>

Submitted on 22 Aug 2022

HAL is a multi-disciplinary open access archive for the deposit and dissemination of scientific research documents, whether they are published or not. The documents may come from teaching and research institutions in France or abroad, or from public or private research centers.

L'archive ouverte pluridisciplinaire HAL, est destinée au dépôt et à la diffusion de documents scientifiques de niveau recherche, publiés ou non, émanant des établissements d'enseignement et de recherche français ou étrangers, des laboratoires publics ou privés.



Distributed under a Creative Commons CC BY-NC 4.0 - Attribution - Non-commercial use - International License

ROBUST OPTIMIZATION OF AN ORGANIC RANKINE CYCLE FOR GEOTHERMAL APPLICATION

Aldo Serafino ^{a,b} *, Benoit Obert ^a, Léa Vergé ^a, Paola Cinnella ^b

^a *Enertime, 1 rue du Moulin des Bruyères, 92400 Courbevoie, France*

^b *Laboratoire Dynfluid, Arts et Métiers ParisTech, 75013 Paris, France*

Abstract

A robust design optimization (RDO) methodology for Organic Rankine Cycles (ORC) is presented, allowing to ensure an improved, stable performance over a large range of operating conditions. In contrast with classical ORC design methods, whereby all modeling hypotheses and operating conditions are considered as perfectly known, i.e. deterministic, the RDO approach allows to account for the manifold sources of uncertainty affecting the system. For geothermal ORC, the latter are related on one hand with the ill-known properties of the geothermal source and, on the other, with intrinsically random parameters, such as the condensation temperature. The proposed RDO approach selects values of the design parameters that maximize the expected (average) performance while minimizing its variance under uncertain nominal operating conditions. The optimal design delivered by the proposed strategy outperforms the one derived from the standard deterministic approach: specifically, the expected power output is increased by 1.5%, while its standard deviation is reduced by 8.5% and the surface of the heat exchangers by 34%.

Keywords: Organic Rankine cycle, design methodology, optimization under uncertainty, robust design optimization, surrogate models

*aldo.serafino@enertime.com, aldo.serafino@ensam.eu

1. Introduction

The development of Organic Rankine Cycles (ORCs) in the last fifteen years has contributed significantly to the enlargement of the commercial exploitation of geothermal power. Specifically, the ORC technology has fostered the use of low-temperature geothermal resources. Data collected by Bertani [1, 2] show a noticeable growth in the worldwide installed geothermal capacity of binary plants (almost exclusively based on ORC technology), which in just 5 years has almost doubled passing from 11% to 14.2% of the overall geothermal applications. Among the 780 MW of new geothermal capacity installed in 2016 [3], almost 30% consists in ORC systems [4].

However, even if nowadays geothermal power is a mature, commercially available and well known technology providing low-cost base load capacity, several sources of uncertainty are hidden in the whole process adopted for its exploitation. Some major sources of epistemic uncertainties in geothermal power generation [5] are listed below:

- temperature of the geothermal reservoir;
- field extent for the definition of the drilling area;
- soil permeability;
- average well production;
- re-injection cost;
- phenomena like quenching, chemical clogging and corrosion.

Among them, just a few can be reduced, investing a considerable amount of time and capital resources in preliminary discovery and exploration activities, while some others can be reduced only through long term operation of the field (about a decade, as an order of magnitude). All of them are due to a lack of knowledge, and for that reason they are qualified as “epistemic” uncertainties [6, 7].

A large amount of literature has been written since the 70s to identify the sources of uncertainty affecting geothermal power and to quantify their effects. A detailed overview can be found for instance in [8]. These sources of uncertainty can lead to the scenario presented in Fig. 1, showing that

32 from an investor viewpoint a geothermal project can be a risky and capital-
 33 intensive investment. The risk derives from the fact that an important part
 34 of the capital is required for preliminary activities like pre-survey, exploration
 35 and test drilling without any certainty about the presence of an exploitable
 36 geothermal resource. For instance, the test drilling can account alone for up
 37 to 15% of the overall capital cost [9], before that the project profitability
 38 can be determined. Moreover, these sources of uncertainty can result in the
 39 oversizing of the geothermal plant, with a significant reduction of profits
 40 and a possible failure of the whole geothermal project. Considering that,
 41 historically, the majority of the worldwide geothermal installed capacity has
 42 been funded mainly through private financing [10], such a scenario can deter
 43 investments in this technology.

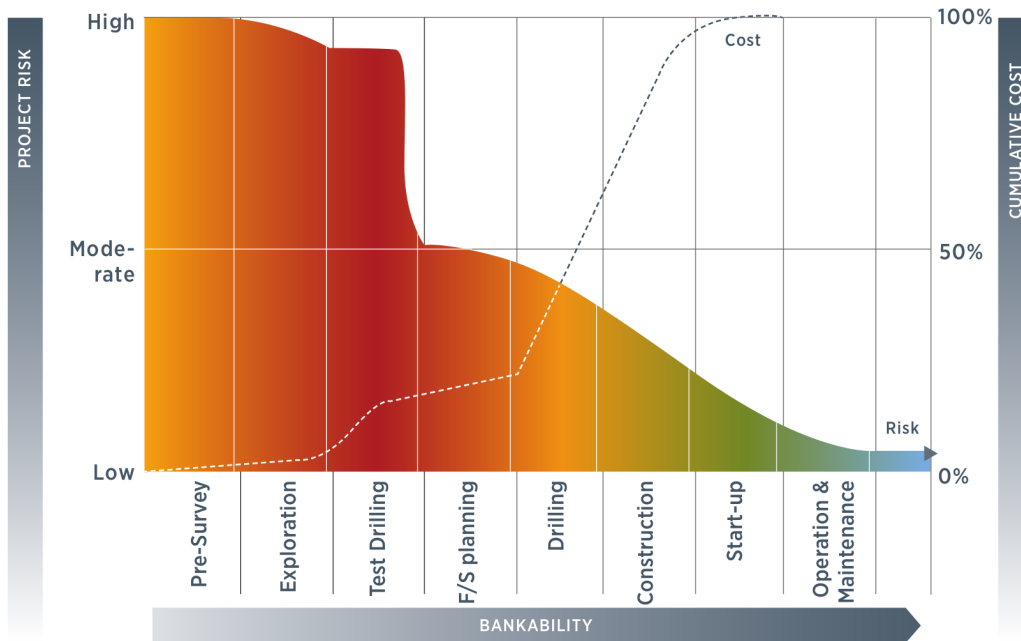

Figure 1: Typical uncertainty and expenditure profiles for a geothermal project [3]

44 Even if there is no reason to believe that the uncertainty and the risk
 45 associated with geothermal fields are any greater than those for other forms of
 46 electricity generation [5], the accurate quantification of geothermal resource
 47 risk is of a paramount importance in the financing of geothermal projects
 48 [11]. The objective of the present work is to employ a promising methodology
 49 aiming to perform the robust design optimization (RDO) of an ORC for a

50 geothermal application, which can take into account all these uncertainties
51 in order to reduce the associated risk.

52 ORC design typically relies on a mathematical model of the cycle, allow-
53 ing to evaluate a set of performance parameters (or cost functions) given a
54 set of design variables. The model is supposed to provide an accurate enough
55 description of the ORC system over a range of operating conditions. Several
56 examples of thermodynamic and techno-economic optimization can be found
57 in [12]. Historically, a black-box strategy has been typically applied, whereby
58 the cycle performance is computed with a simulation code, while the design
59 parameters are optimized with an evolutionary algorithm (e.g. simulated
60 annealing, particle swarm, artificial bees colony or genetic algorithms); some
61 examples can be found in [13, 14, 15, 16, 17, 18, 19]. For several years, the
62 analysis has been carried out solely at a fixed design point, corresponding to
63 the nominal working conditions of the ORC plant. Only recently some ther-
64 modynamic and techno-economic optimizations have been carried out consid-
65 ering also part-load performance: a first contribution has been given by [20].
66 Other interesting applications can be found in [21, 22, 23, 24, 25, 26, 27, 28].
67 Part-load performance is evaluated by means of dynamic simulations [12] or,
68 more often, through steady state calculations at off design conditions [27].
69 In all cases, the optimization process is deterministic in the sense that the
70 design variables, the operating conditions and any other input required by
71 the model, as well as the model itself, are supposed as perfectly known.

72 However, due to epistemic and aleatory uncertainties in the operating
73 conditions (as discussed in the above), the values to be input to the code are
74 more properly described as random variables. Consequently, the performance
75 of the system, which is obtained as the model output, is also random. An
76 essential step is therefore to estimate the probability distribution function
77 (PDF) describing the random variations of performance parameters. Such
78 information can subsequently be used in the process to design ORCs with
79 a controlled performance uncertainty. Design strategies for the optimization
80 of a system subject to uncertainties are known as robust design optimization
81 (RDO) methods [29]. Several RDO strategies exist, e.g. [30, 31, 32].

82 In this work, we focus on Taguchi's RDO approach [30], which looks
83 for the maximization (or, depending on the problem, minimization) of the
84 expectancy of a set of cost functions while minimizing at the same time their
85 variances, thus reducing the sensitivity of the optimal design to uncertain
86 parameters. For that purpose, the uncertain input parameters are assigned
87 probability distributions, and an uncertainty quantification (UQ) method is

88 used to propagate them through a mathematical model of the system and
 89 to obtain the expected (average) values and the standard deviations of the
 90 output performance parameters (the cost functions). The UQ algorithm is
 91 then coupled with a multi-objective optimizer, allowing to determine the
 92 optimal designs with respect to the multiple cost functions.

93 In the context of ORC design under uncertain operating conditions, RDO
 94 represents a promising alternative to standard design methods [33], allowing
 95 to ensure a more stable performance over a range of randomly varying oper-
 96 ating conditions.

97 The paper is presented as follows: Section 2 presents the ORC model
 98 employed in the calculations; Sections 3 and 4 describe the UQ methodology
 99 and the proposed RDO loop, respectively. Numerical results are presented
 100 in Section 5 and Section 6. Final remarks and conclusions are provided in
 101 Section 7.

102 2. ORC model

103 The object of the RDO carried out in this study is an ORC for geothermal
 104 application, whose plant layout is depicted in Fig. 2.

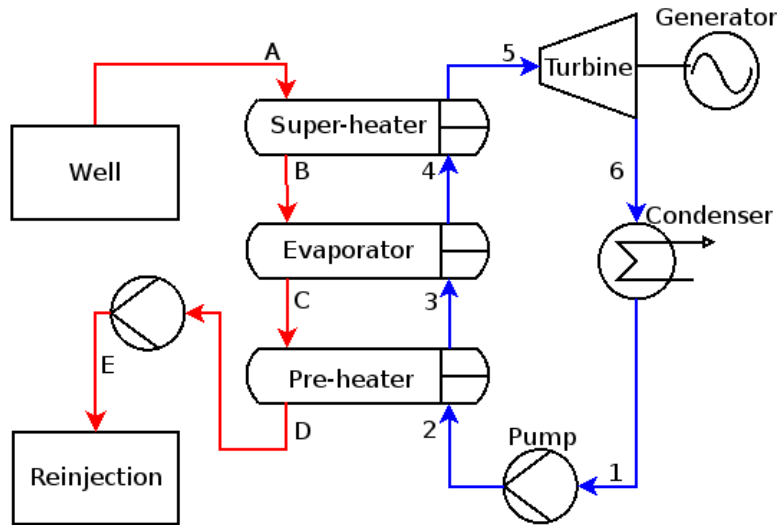

Figure 2: Layout of the geothermal plant

105 The plant exploits geothermal brine in a single-pressure ORC employing
 106 iC4 as the working fluid. As depicted in Fig. 2, the brine is cooled-down

107 before the re-injection by a set of heat exchangers (HEXs). These include
108 a pre-heater (PRE), an evaporator (EVA) and, eventually, a super-heater
109 (SH) where heat is transferred to the ORC working fluid. The PRE is a shell
110 and tube heat exchanger, while the EVA is a kettle reboiler. The vapour of
111 the working fluid, which can be saturated or superheated (depending on the
112 outcomes of the RDO), expands in an axial turbine directly connected with
113 the generator by means of a coupling disc. The condenser (CD) is a shell
114 and tube heat exchanger using water, which is cooled in a wet cooling tower
115 to condensate the vapour coming from the discharge of the turbine. Finally,
116 the pump is of the centrifugal type and it is connected to an electrical driver
117 equipped with a variable-frequency drive.

118 An in-house deterministic model for ORC systems written in Python is
119 used for the design and the off-design simulation of the cycle, described in
120 [34]. A brief overview of both design and simulation algorithms is provided
121 hereafter for completeness.

122 The design algorithm, which is sketched in Fig.3, defines the proper size
123 of all ORC components, in order to evaluate the performance and the cost
124 of the whole system. Therefore, first the nominal operating conditions of
125 the cycle should be assigned; these include the characteristics of both hot
126 and cold energy sources and, more specifically, the nominal temperature,
127 mass flow rate and specific heat capacity of the geothermal brine, the brine
128 re-injection temperature (which is fixed at 353.15 K, to avoid corrosion and
129 deposition issues), the inlet temperature and the mass flow rate of the cooling
130 water. Additional inputs required by the model are:

- 131 • the subcooling,
- 132 • the superheating (ΔT_{SH}),
- 133 • the isentropic efficiency of the turbine,
- 134 • the efficiency of the pump,
- 135 • the pressure drops across the HEXs,
- 136 • the pinch points in the evaporator and in the condenser.
- 137 • the working fluid.

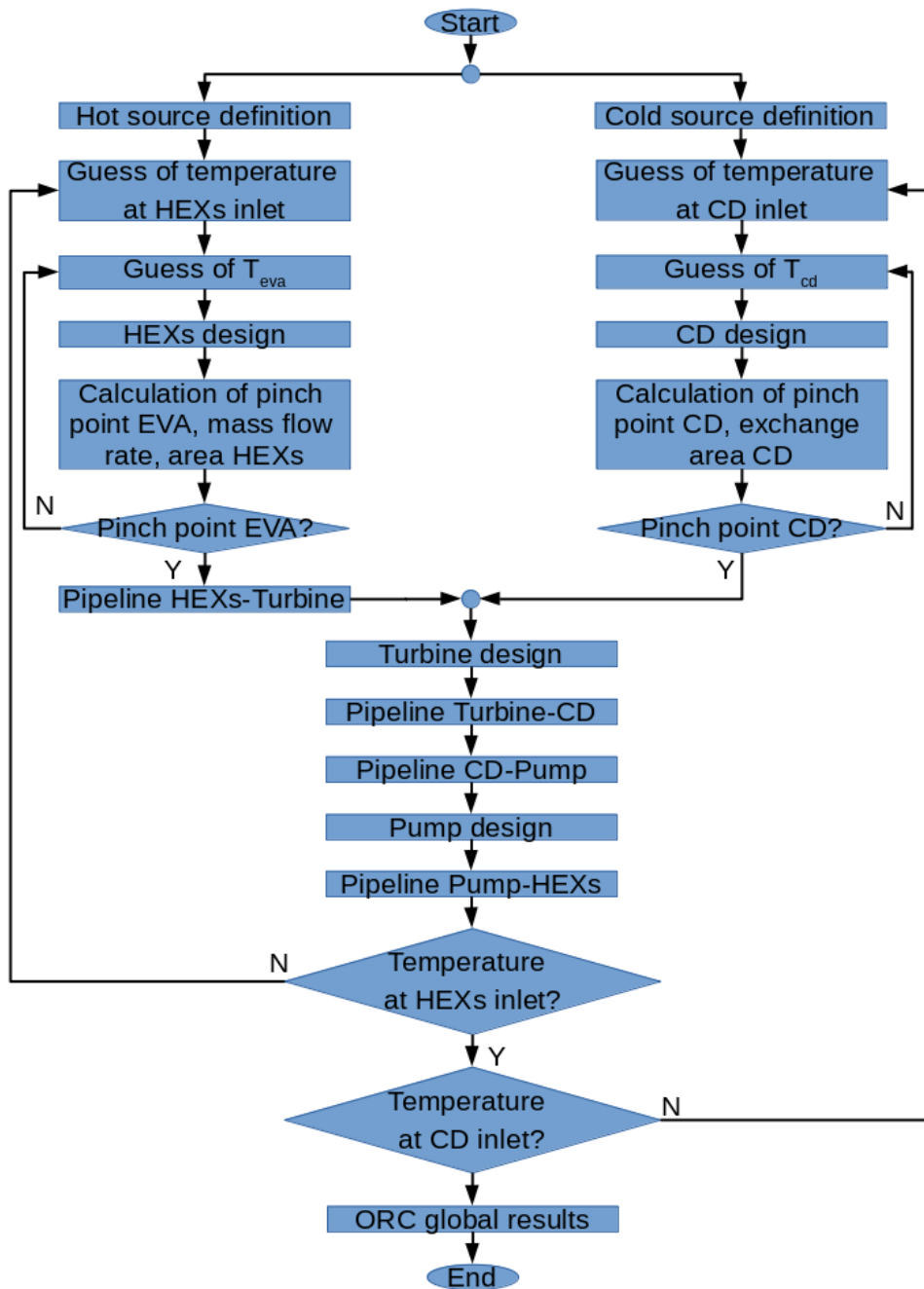

Figure 3: Flowchart of the ORC model in design mode (nominal conditions).

138 The turbine is designed to perform 85% isentropic efficiency at the design
139 point, while the pump is chosen with a 70% overall efficiency. The PRE,
140 the EVA and the SH (considered all together as a single block of HEXs) and
141 the condenser are modelled with the generalized moving-boundary algorithm
142 proposed in [35]; the ϵ -NTU method [36] is then used to estimate the exchange
143 area at the ORC nominal point. Moreover, in order to have in the evaporator
144 only the change of phase of iC4, a subcooling of 0.5 K of the working fluid is
145 considered at the EVA inlet. The thermodynamic properties of the working
146 fluid are calculated via the Coolprop 6.1.0 library [37].

147 Following the algorithm in Fig.3, once that both hot and cold sources are
148 specified, the model can start with the design of the HEXs and of the con-
149 denser, which requires an initial guess of the temperature of the working fluid
150 at the inlet of the condenser and of the HEXs block, as well as of the evap-
151 orator and condenser temperatures (respectively, T_{eva} and T_{cd}). The input
152 data presented in Fig.4 are used to model the condenser and the HEXs. As
153 an output of the design of these components, an estimation of the exchange
154 areas, of the ORC mass flow rate and of the pinch points in the EVA and the
155 condenser is provided; these two last quantities are used to check the pinch
156 point values set at the beginning.

157 If the calculated pinch point values do not match to the fixed ones, a
158 new guess of T_{eva} and T_{cd} is considered and a new run is performed. In the
159 code, this iterative search of the roots is carried out with the Nelder-Mead
160 algorithm [38] implemented in the Python library Scipy [39]. Once that the
161 pinch-point values have been converged to within a tolerance of $10^{-4}K$, the
162 algorithm proceeds with the design of the turbine, of the pump and of the
163 pipelines between each item. The input data used for the design of each
164 component are also listed in Fig.4. For the pipelines, a target pressure drop
165 is imposed and the pipe diameters are calculated using the Colebrook-White
166 correlation [40].

167 Before the end of the design, a check on the temperature of the working
168 fluid at the inlet of the condenser and of the HEXs block is done: if the
169 calculated values differ from the initial guess by more than $10^{-4}K$, these
170 quantities are updated and a new run of the code is performed. When the
171 convergence is reached, the design model outputs a list of parameters corre-
172 sponding to the characteristics of the ORC. Tab.1 shows typical results for
173 the design of an ORC.

174 Thus, the ORC model is first applied in the so-called design mode, to
175 select the ORC design providing the best deterministic performance, at pre-

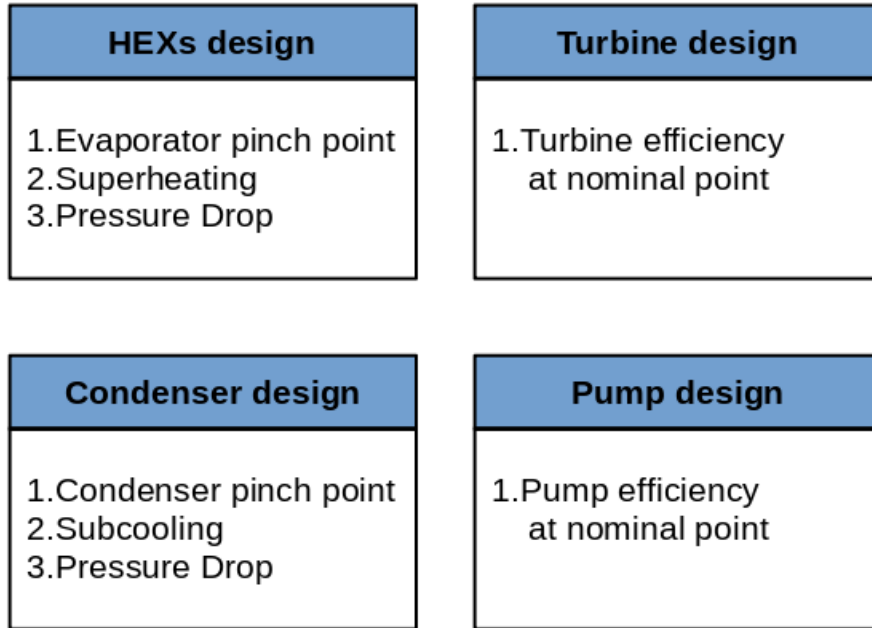

Figure 4: Input data for the design of the main components of the ORC at nominal conditions

176 specified nominal design conditions. The ORC off-design performance is then
 177 evaluated by running the model in the simulation mode, illustrated in the
 178 flowchart of Fig.5.

179 The hot and the cold sources are assigned for off design operating condi-
 180 tions: these include the mass flow rate, inlet temperature and specific heat
 181 capacity of the geothermal brine, and the inlet temperature and mass flow
 182 rate of the cooling water. A first guess for T_{eva} and T_{cd} is used to define the
 183 thermodynamic state at the inlet of the turbine and of the pump; pressures
 184 at the outlet of both components are also calculated. The input parameters
 185 of Fig.6, along with empirical correlations given by Enertime are used to cal-
 186 culate the pump and turbine off-design isentropic efficiencies. The turbine
 187 simulation allows to compute the ORC mass flow rate; with this last piece
 188 of information, one can simulate the pipelines between the turbine and the
 189 condenser and the one between the pump and the HEXs, obtaining an estima-
 190 tion of pressure drops in each line knowing its own diameter. Furthermore,
 191 the HEXs and the condenser can be also simulated: the same generalized
 192 moving-boundary algorithm already employed in the design mode, is now

Table 1: Some major results from the ORC design module

#	Results from the ORC design module
1	ORC mass flow rate
2	Pressure at evaporator (P_{eva})
3	ΔT_{SH}
4	Turbine Inlet Pressure
5	Turbine Outlet Pressure
6	Pressure at condenser (P_{cd})
7	Thermodynamic points of the ORC @ nominal point
8	Pump mechanical power
9	Cooling water mass flow rate
10	Thermal power input
11	Turbine mechanical power
12	Turbine electric power
13	ORC net power ($W_{ORC,net}$)
14	ORC efficiency
15	Exchange area of PRE
16	Exchange area of EVA
17	Exchange area of SH
18	Exchange area of CD
19	Diameter of the pipe between EVA and turbine
20	Diameter of the pipe between CD and pump
21	Diameter of the pipe between turbine and CD
22	Diameter of the pipe between pump and EVA

193 used to define the thermodynamic state at the boundaries and inside the
 194 HEXs block and the condenser, while the ϵ -NTU method is still utilized to
 195 compute the exchange area of both these two items. Finally, the areas of
 196 the HEXs and of the condenser are used to check convergence: if the values
 197 calculated in the simulation mode differ from the design values at nomi-
 198 nal conditions by more than $10^{-6} m^2$, a new guess value of T_{eva} and T_{cd}
 199 is considered and a new run is performed. To iterate through T_{eva} and T_{cd}
 200 the multi-objective COBYLA optimization algorithm [41] available in the
 201 Python library Scipy is used.

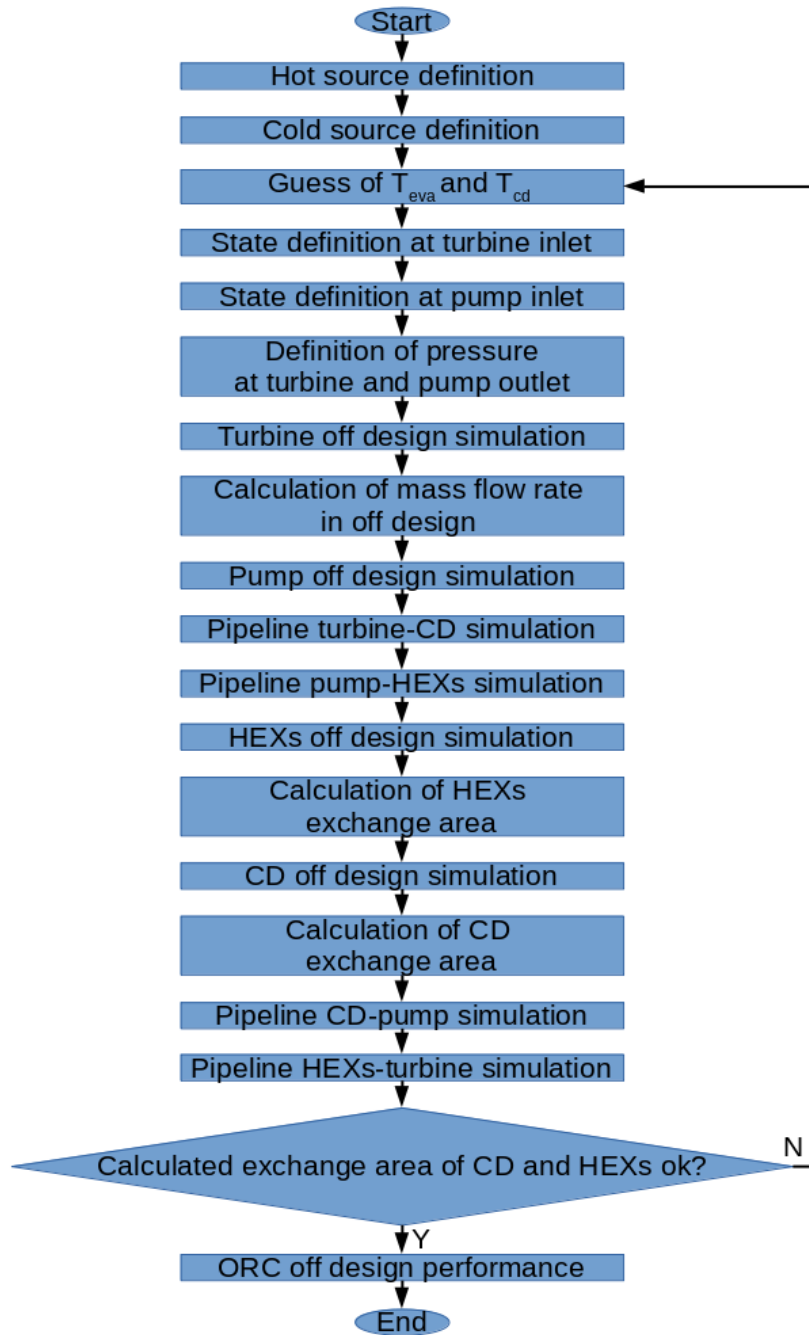

Figure 5: Algorithm of the ORC simulation model for off design

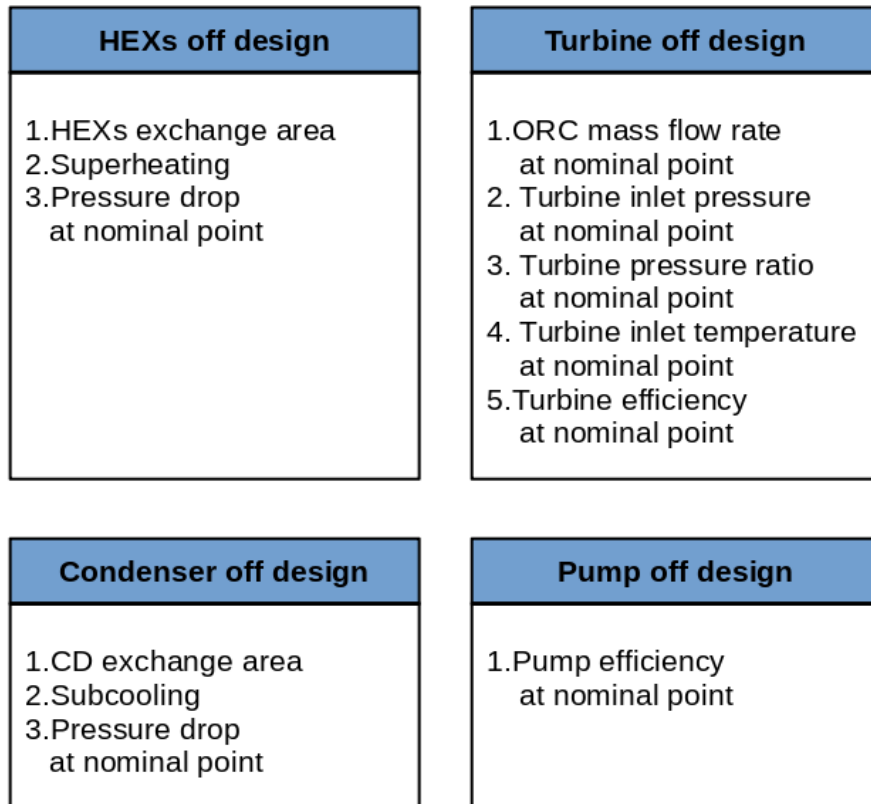

Figure 6: Input data for the simulation of the main components of the ORC in off design conditions

202 In the following, the deterministic ORC model is coupled with an uncer-
 203 tainty quantification method, described in the next section, to account for
 204 uncertainties in the nominal conditions.

205 3. ORC Uncertainty quantification

206 The goal of uncertainty quantification (UQ) is to estimate variability in
 207 the output of a model, corresponding to a set of Quantities of Interest (QoIs),
 208 given variations in the model inputs. Hereafter, we adopt a probabilistic
 209 approach which aims at predicting the probability density distributions of
 210 the output QoIs, given some probability distributions assigned to the inputs.
 211 For that purpose, a numerical algorithm is used to propagate the input PDFs
 212 through the model, here treated as a black box, leading to approximated PDF

213 (e.g., histograms) for the QoIs. This process is sketched in Fig.7.

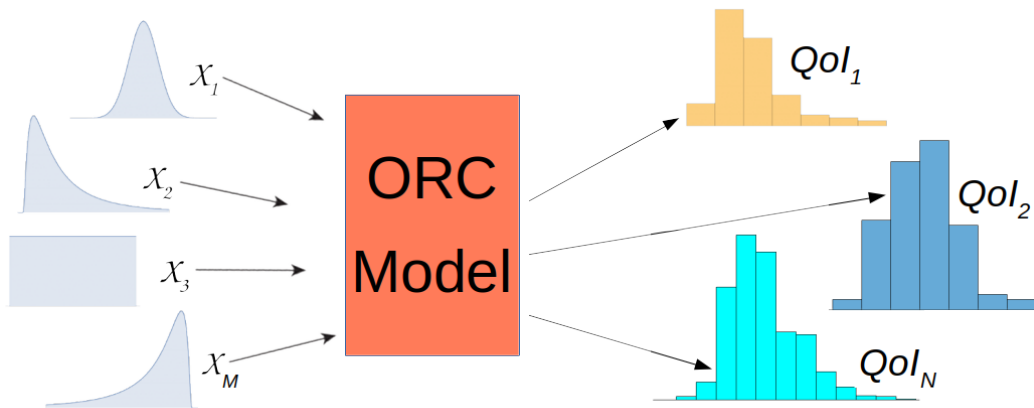

Figure 7: General sketch of the UQ process of the ORC

214 For the ORC model considered in the present work, the uncertain inputs
 215 are the operating conditions (hot and cold source characteristics) and the
 216 uncertain output QoIs are ORC performance parameters (i.e. cycle efficiency
 217 or power output) or ORC working characteristics, such as the mass flow rate.
 218 In the next Section, we discuss the selection of performance parameters that
 219 will serve as cost functions for the RDO.

220 3.1. Selection of the uncertain ORC performance parameters

221 The uncertain parameter selected in the present work as the target of the
 222 UQ algorithm and, subsequently, of the RDO strategy is the ORC net power,
 223 $W_{ORC,net}$. This is calculated as the difference of the electric power delivered
 224 by the generator and the sum of all consumption devices, namely, the feed
 225 pump and the auxiliaries like the cooling tower system, the oil system, the
 226 air compressors and the control room system. $W_{ORC,net}$ is here preferred
 227 to the global cycle efficiency, defined as the ratio of the ORC net power to
 228 the total heat content of the heat source: in fact, for a randomly varying
 229 thermal input, global efficiency does not necessarily correspond to the max-
 230 imum power output operation of the ORC system. This happens because
 231 during the optimization, in case of an increase in the evaporation pressure,
 232 an increased cycle efficiency can be obtained at the cost of a decrease in the
 233 amount of heat extracted from the heat source. Therefore, instead of consid-
 234 ering a possible trade-off between these two quantities, in the present study

235 we have chosen to work only with $W_{ORC,net}$, as it is an extensive quantity
236 which is easier to be used in the optimization with respect to any possible
237 constraint about the size of the plant.

238 To evaluate the influence of uncertain inputs on the selected QoI, the
239 ORC model is first run in the design mode, with nominal conditions fixed
240 to the average values of the input parameters. This allows to determine the
241 geometrical characteristics of the ORC. Afterwards, the ORC model is run
242 several times in the simulation mode for a set of conditions sampled from the
243 input PDFs, and the corresponding values of the output QoI are used to build
244 an approximation of its PDF and of its main statistical moments (mean and
245 variance).

246 3.2. Identification of sources of uncertainty

247 The ORC system under investigation is affected by two major uncertain-
248 ties: the first is of epistemic nature, as it is due to the lack of complete infor-
249 mation about the characteristics of the geothermal heat source; the second
250 one is aleatory and associated with the random variations of the temperature
251 of the cold medium at the condenser.

252 About the first uncertainty, Sanyal and Morrow [11] conducted a local sen-
253 sitivity study on the internal rate of return for a typical geothermal project,
254 and illustrated that the most sensitive variables are resource parameters.
255 Hereafter this uncertainty is considered as the outcome of the interaction of
256 three sources of epistemic uncertainty, namely:

- 257 1. mass flow rate of the geothermal brine \dot{m}_{geo} ,
- 258 2. temperature of the geothermal brine T_{geo} ,
- 259 3. heat capacity of the geothermal brine c_{geo} .

260 Based on information available in the technical literature (see for instance
261 [42, 43, 44, 45]), the preceding quantities are modelled as independent Gaus-
262 sian random variables, whose parameters are listed in Tab. 2.

263 Regarding the temperature of the cooling water $T_{cw,in}$ at the inlet of the
264 condenser, the observation of historical data could be used to infer a probabil-
265 ity distribution modelling for this source of aleatory uncertainty. However,
266 for the present work, no data were available; therefore, some information
267 found in literature [45, 46] was used to model this quantity as a Gaussian
268 random variable, with parameters also reported in Tab. 2.

Table 2: Parameters of ORC uncertain variables, modelled by Gaussian PDFs

Parameter	Distribution	Mean	Variance
\dot{m}_{geo}	Gaussian	162.0 $kg s^{-1}$	72.25 $kg^2 s^{-2}$
T_{geo}	Gaussian	388.15 K	6.25 K^2
c_{geo}	Gaussian	4.2 $kJ kg^{-1} K^{-1}$	0.0025 $kJ^2 kg^{-2} K^{-2}$
T_{cw_in}	Gaussian	297.15 K	4 K^2

269 *3.3. Uncertainty propagation*

270 The objective of an UQ algorithm is to propagate input uncertainties
 271 through a model and estimate the PDF of output QoIs and/or their statistical
 272 moments. A large variety of UQ methods is available in the literature, the
 273 simplest and more general one being the Monte Carlo approach [47]. This
 274 consists in drawing samples from the input PDFs, and to compute for each
 275 of them the corresponding model outputs for the QoIs. The results may be
 276 used to construct an histogram of the output QoIs or to compute means
 277 and variances. Unfortunately, a very large number of samples is required to
 278 converge the statistics, which makes the Monte Carlo approach inapplicable
 279 to costly models. In [33] the Monte Carlo approach is successfully applied to
 280 the UQ and RDO of an ORC for automotive applications described through
 281 a simplified and inexpensive steady-state model, but a significant reduction
 282 of the number of samples is mandatory for extending its use to more realistic,
 283 complex models.

284 A way for alleviating the cost of uncertainty quantification is to project
 285 the system’s response onto a suitable basis of analytical functions (often
 286 called a surrogate model) with coefficients estimated from a (possibly) small
 287 set of samples drawn from the costly model. The cheap surrogate is then
 288 used to evaluate Monte Carlo samples or to directly compute approximations
 289 of the statistical moments for the output quantities. An overview of UQ
 290 methods is out of the scope of this paper; examples can be found, e.g. in
 291 [48, 49, 50].

292 In the present work, we adopt a so-called Kriging surrogate model (see
 293 [51] for a review of Kriging methods). More specifically, a Bayesian Kriging
 294 surrogate is constructed from a design of experiments (DOE), which is a set
 295 of initial samples drawn from the simulation mode of the ORC model. The
 296 Kriging surrogate is used to approximate the behaviour of the costly ORC

297 model, and more specifically the response of the QoI to random variations of
298 the uncertain inputs, as a cheap analytical function. The latter corresponds
299 to the realization of a Gaussian process [52]. A detailed description of the
300 Bayesian Kriging surrogate is beyond the scope of this paper. The interested
301 reader is referred to Refs [53, 54, 55, 56] for more details. A proof of concept
302 of Bayesian Kriging for the UQ of an ORC for waste heat recovery is available
303 in [57].

304 Once the Bayesian Kriging surrogate has been trained on the DOE, a
305 Monte Carlo sampling of the input PDF is carried out, as in the standard
306 Monte Carlo method, and the QoI is evaluated for each sample using the
307 analytical inexpensive surrogate instead of the full ORC model. The whole
308 process can be summarized through the following steps:

- 309 1. Set the operating conditions to their average values, and run the ORC
310 model in the design mode to determine the geometrical characteristics.
- 311 2. Build the DOE, by drawing a small set of samples, of size N , from the
312 input PDF; these corresponds to multiple random combinations of the
313 operating conditions.
- 314 3. For each sample, run the ORC model in simulation mode and determine
315 the value of the QoI.
- 316 4. Use the data collected at points 2 and 3 to build the kriging surrogate
317 function K : $\text{QoI} = K(\mathbf{X})$.
- 318 5. Draw a large set of samples, of size S , from the input PDF.
- 319 6. For each sample of point 5, compute the QoI from the kriging surrogate.
- 320 7. Use the results of point 6 to build an histogram of the QoI and/or to
321 compute statistics (mean value of QoI, variance of QoI)

322 In the following calculations, the samples of point 2 are extracted by using
323 the Latin Hypercube Sampling (LHS) criteria [58]. A preliminary accuracy
324 study for a related case [57] has been here considered to select a number of
325 Kriging samples providing the best tradeoff between cost and accuracy.

326 4. ORC optimization strategy

327 In order to design an ORC with a stable performance under the uncertain
328 inputs, a RDO strategy is considered: the ORC model is coupled with an
329 UQ method and an optimization algorithm to select design parameters that
330 maximize (or depending on the problem, minimize) the expected (average)

331 value of a set of design criteria while optimizing some of their statistical
332 properties, which are then added to the set of the cost functions.

333 In the following, we adopt the RDO criterion of Taguchi [30] which con-
334 sists in optimizing the expectancy (statistical average) of some cost functions
335 minimizing their variance at the same time.

336 More precisely, the following cost functions (CFs) are selected for the
337 present work:

- 338 1. CF1 is the mean value of the PDF of the QoI ($E[W_{ORC,net}]$),
- 339 2. CF2 is the variance of the PDF of the QoI ($var[W_{ORC,net}]$),
- 340 3. CF3 is the global area of HEXs A_{ORC} .

341 The latter has been chosen as an indicator of the cost of the ORC: in
342 fact, as a first approximation the cost of HEXs is proportional to their area,
343 while the cost of components like the turbine and the pump is less sensitive
344 to the design parameters as they benefit from a kind of economy of scale, due
345 to the fact that the fix part of their cost is usually quite important and the
346 variable part is usually proportional to their rated power. Consequently, the
347 optimization problem has 3 objectives, which are the maximization of CF1,
348 the minimization of CF2 and the minimization of CF3.

349 The design variables of the optimization process are the source character-
350 istics \dot{m}_{geo} and T_{geo} and the condensation temperature T_{cd} . Such parameters
351 are uncertain, as discussed in the preceding sections. An additional design
352 parameter, the superheating ΔT_{SH} , is also considered, and it is treated as
353 deterministic. As an outcome of the UQ analysis performed (see results in
354 Section 5), any other source of uncertainty, and namely c_{geo} , is neglected
355 and the corresponding input parameters are set to their average values and
356 assumed as deterministic.

357 The RDO algorithm, whose flowchart is depicted in Fig.8, proceeds as
358 follows:

- 359 1. A nominal design point is randomly sorted from the input parameter
360 distribution.
- 361 2. The ORC model is run in the design mode with deterministic inputs,
362 determined at Point 1.
- 363 3. As an outcome of Point 2, the ORC characteristics are defined, includ-
364 ing A_{ORC} .
- 365 4. The operating conditions are then randomly perturbed, according to
366 their PDFs.

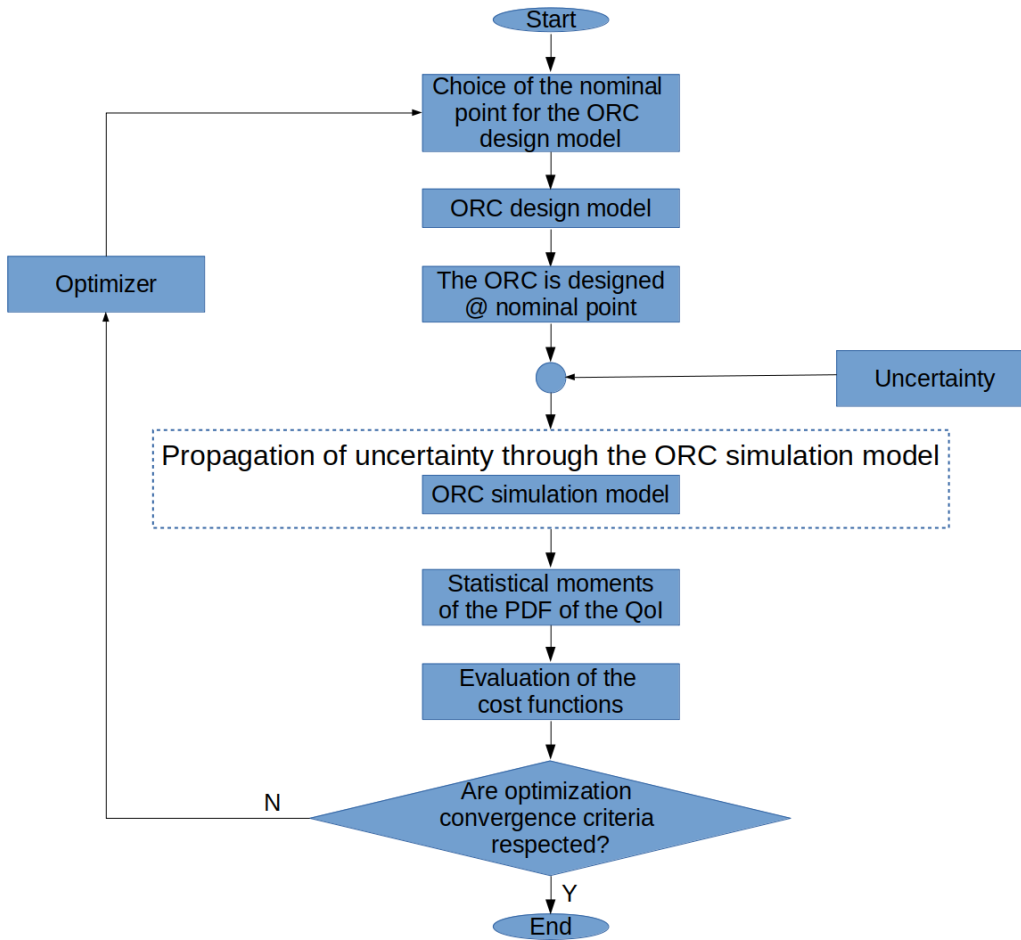

Figure 8: RDO simplified scheme

- 367 5. The random samples are propagated through the ORC model in simu-
 368 lation mode.
 369 6. The cost functions CF1 and CF2 are evaluated as statistical moments
 370 of the QoI $W_{ORC,net}$.
 371 7. Based on the values of the cost functions, a new set of design variables
 372 is selected and the process is repeated from Point 2.

373 In the present work, the optimizer is the multi-objective non-dominated
 374 sorting genetic algorithm (NSGAI) [59]. The design parameters space is
 375 defined by the support of the PDFs for the uncertain parameters and the
 376 interval $[0, 4]$ K for ΔT_{SH} .

377 In the genetic algorithm, an initial population of 40 individuals (alterna-
 378 tive nominal designs) is let to evolve over 80 generations. The evaluation of
 379 the cost functions for each individual corresponds to an UQ calculation, as
 380 described in Section 3. To alleviate the computational cost of the optimiza-
 381 tion process, the RDO is conducted by using two nested Bayesian Kriging
 382 (TNBK) surrogates, as in [56, 57].

383 The inner Kriging surrogate is used for UQ and the evaluation of CF1
 384 and CF2, while the outer surrogate, describing variation of the CFs with the
 385 design parameters, is directly coupled with the optimizer. The workflow of
 386 the surrogate-based RDO, represented in Fig.9, proceeds as follows.

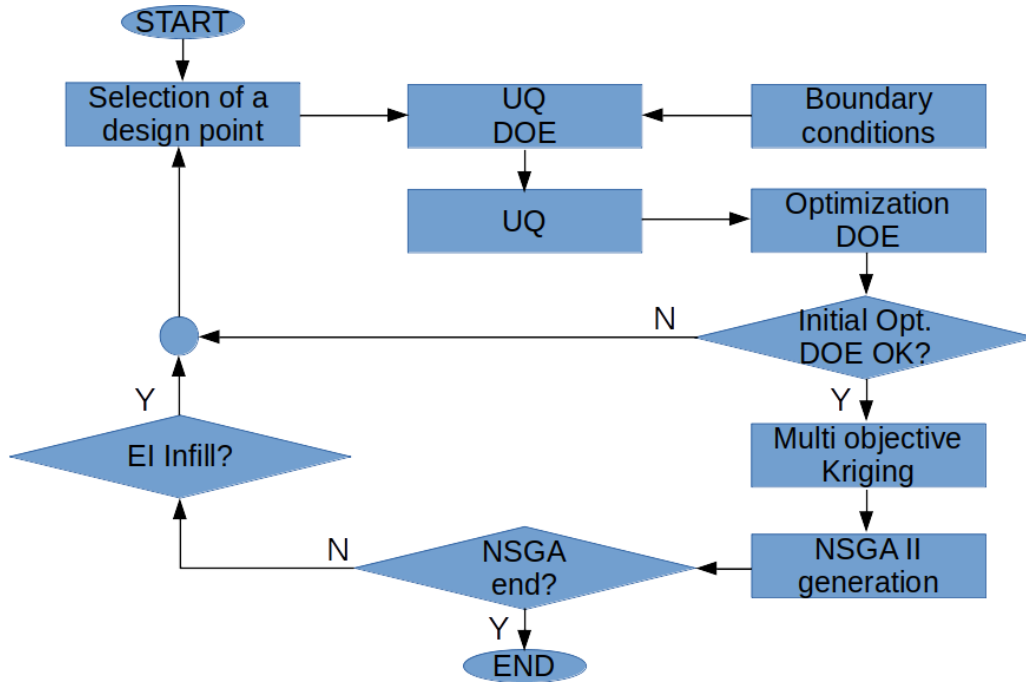

Figure 9: RDO detailed algorithm

- 387 1. An initial population, corresponding to 40 alternative design conditions
 388 is selected through LHS of the parameter space.
 389 2. For each design, a UQ calculation is carried out based on the workflow
 390 in Fig. 8 and the cost functions are computed.
 391 3. The external Bayesian Kriging relating the design variable to the cost
 392 functions, is constructed from the data collected at Point 1 and Point
 393 2.

394 4. The NSGA II algorithm is run on the Kriging surrogate until conver-
395 gence criteria are met.

396 In order to increase the accuracy of the external Kriging surrogate, during
397 the NSGA II iterations an adaptive infill strategy based on the expected
398 improvement (EI) criterion is used to add new samples to the initial set
399 of data. Precisely, the infill procedure identifies a new design, whose cost
400 functions are calculated with the full ORC model. The new point is then used
401 to retrain the Kriging surface and the NSGA II is continued on the improved
402 model. Based on numerical tests, we observed that applying an adaptive
403 infill every 5 generations enables an accurate estimate of the optimal design.
404 The cost functions of the optimal designs are finally recomputed exactly with
405 the UQ solver in order to verify the residual errors.

406 5. UQ results and global sensitivity analysis

407 The sensitivity of the selected QoI, i.e. the ORC net power $W_{ORC,net}$,
408 to random variations of the uncertain parameters described in Section 3.2 is
409 first investigated by means of the UQ algorithm described above. The ORC
410 model is first run in the design mode, with input parameters corresponding
411 to the average values of Tab. 2. Afterwards, the ORC power output under
412 random variation of the uncertain parameters is determined from a Bayesian
413 Kriging surrogate of the ORC model in the simulation mode. More specifi-
414 cally, 50 LHS are drawn from the distribution of the uncertain parameters,
415 and the resulting 50 sets of inputs are supplied to the ORC model to obtain
416 the output $W_{ORC,net}$. A Bayesian Kriging surrogate of the output is then
417 used to approximate the ORC model response for any value of the uncertain
418 parameters. A set of 10^6 Monte Carlo samples is drawn from the input dis-
419 tributions and an approximation of $W_{ORC,net}$ is evaluated from the surrogate
420 for each of them. These values are used to build a normalized histogram, re-
421 ported in Fig. 10. We observe that the histogram follows closely a Gaussian
422 distribution (also reported in the figure), with a standard deviation equal to
423 approximately 14% of the mean value.

424 The UQ results are also used to carry out a global sensitivity analysis of
425 the QoI to the uncertain parameters. For that purpose, we apply the anal-
426 ysis of variance (ANOVA) decomposition [60], and we use the Monte Carlo
427 samples to estimate Sobol indexes [61] associated to the uncertain inputs.
428 More specifically, for each input parameter we extract the first-order and

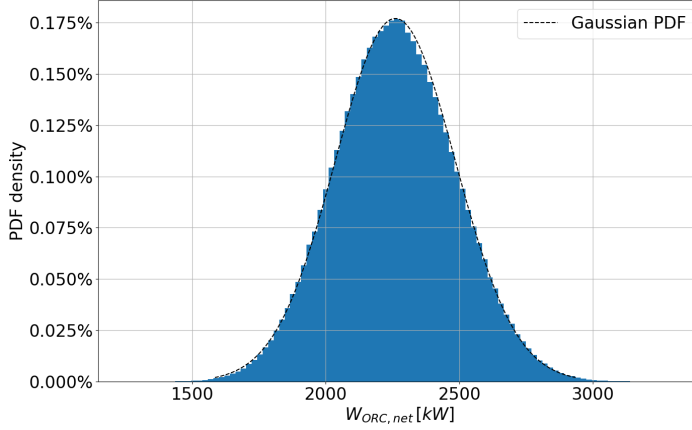

Figure 10: Histogram of the QoI $W_{ORC,net}$ under uncertainty

429 total Sobol indexes. The reader is referred to [62] for more details on Sobol
 430 global sensitivity analysis. Here we just recall that the first-order Sobol
 431 indexes measure the effect on the variance of the output QoI when perturbing
 432 each input parameter individually. The total Sobol indexes represent instead
 433 the overall contribution of a given input to the total variance of the output,
 434 when such a parameter is perturbed individually or in conjunction to other
 435 parameters. By construction, the Sobol indexes are numbers comprised be-
 436 tween 0 and 1. Higher values indicate a stronger sensitivity of the QoI to a
 437 given parameter.

Table 3: Global sensitivity analysis with Sobol indexes

	Sobol 1st order	Sobol Total
\dot{m}_{geo}	17.6%	18.0%
T_{geo}	64.4%	64.7%
c_{geo}	0.40%	0.50%
T_{cd}	17.1%	17.4%

438 The results are reported in Tab.3 and Fig.11. The table shows that the
 439 first-order and total indexes are very close to each other, indicating that
 440 coupled effects due to the simultaneous variation of multiple inputs are small

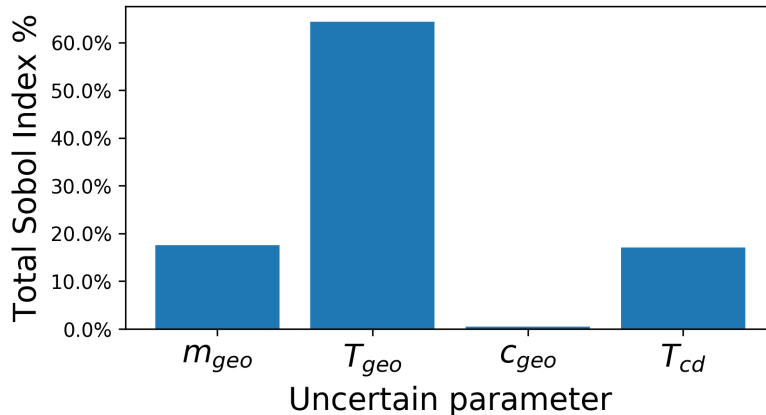

Figure 11: Total Sobol Index from Global sensitivity analysis

441 and that the system output is, to a good approximation, a linear function of
 442 the inputs. This is consistent with the Gaussian shape of the output PDF
 443 in Fig. 10 (a linear transformation of a Gaussian is a Gaussian). Fig.11
 444 highlights the relative influence of the input parameters on the variance of
 445 the QoI $W_{ORC,net}$. The results show that the source temperature T_{geo} is by
 446 far the most important influential parameter. The brine mass flow rate \dot{m}_{geo}
 447 and the condenser temperature T_{cd} also play a significant role, while the effect
 448 of c_{geo} can be neglected.

449 6. RDO results

450 The NSGA II algorithm allows to find an approximation of the Pareto
 451 front of sub-optimal solution, corresponding to different compromise solu-
 452 tions among the various objective. More precisely, the Pareto front is the
 453 subset of designs, for which all objective functions are equal or better than
 454 for all other designs. For the present RDO problem, the objective space has
 455 three dimensions and a graphical representation of the Pareto-optimal solu-
 456 tions is difficult. Fig.12 and Fig.13 show all the solutions computed by the
 457 NSGA II during the convergence process (blue dots) as well as the Pareto
 458 front (black line) in two dimensional subspaces. The cost functions are ap-
 459 proximated from the Kriging surrogate.

460 Fig.12, corresponding to a scatter plot of CF2 versus CF1, shows a posi-
 461 tive correlation between the first two cost functions, as the optimizer finds
 462 some design maximizing the mean value of the PDF of $W_{ORC,net}$, maximiz-

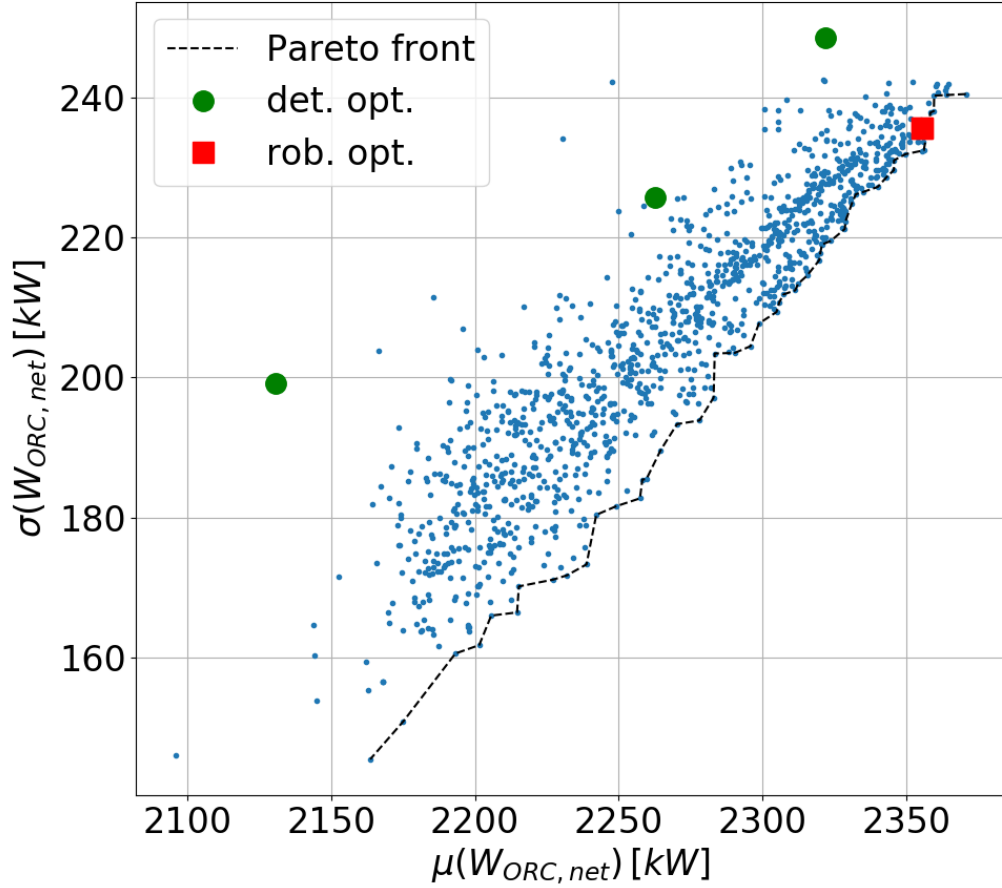

Figure 12: Objective space – CF1 vs CF2

463 ing at the same time its variance. Such a trend is also observed in Fig.13,
 464 where it appears that the maximization of the expected net power output
 465 corresponds to higher values of A_{ORC} . As a consequence, a unique optimum
 466 solution does not exist and different compromise solutions among the cost
 467 functions are possible.

468 Among all the designs lying on the Pareto front, we select the one offer-
 469 ing the best trade-off among all optimization targets; the selected design is
 470 represented as a red symbol in Fig.12 and Fig.13 and it is identified by the
 471 parameters reported in Tab.4. The main characteristics of the final RDO
 472 design are listed in Tab.5.

473 The selected sub-optimal designs is input to the UQ solver, to verify the

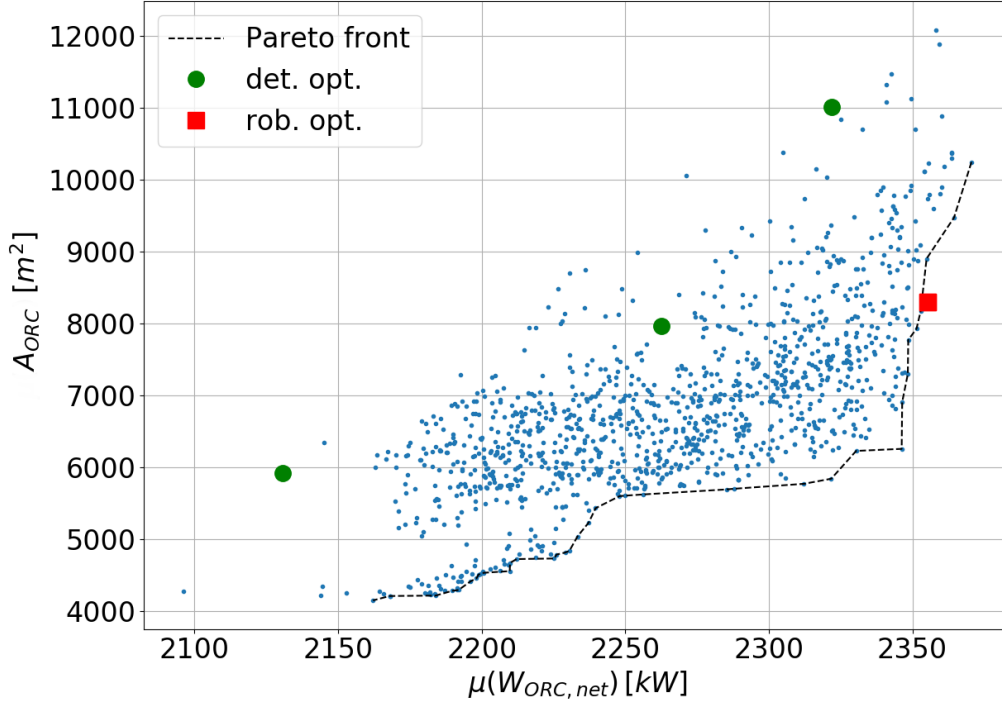

Figure 13: Objective space – CF1 vs CF3

Table 4: Optimal solution as a compromise of the optimization targets

\dot{m}_{geo}	T_{geo}	T_{cd}	ΔT_{SH}
148.1 $kg s^{-1}$	391.6 K	301.0 K	1.0 K

474 accuracy of the Kriging estimates of the cost functions by comparison with
 475 the full model. The distance between this solution and the line of the optimal
 476 solutions calculated with the TNBK approach, i.e. the surrogate approxima-
 477 tion error, is found to be always lower than 5%. Despite this deviation, the
 478 selected design point outperforms the results of the deterministic optimiza-
 479 tion (green large dots in Fig.12 and Fig.13) carried out in three design points
 480 corresponding respectively to average, minimum and maximum conditions
 481 for the geothermal source, according to the PDFs in Tab.2.

Table 5: Optimal solution as a compromise of the optimization targets

Quantity	Unit	Value
ORC nominal mass flow rate	$kg s^{-1}$	61.1
ORC nominal evaporation pressure	bar	16.56
Superheating	K	1.0
Turbine nominal inlet pressure	bar	15.86
Turbine nominal outlet pressure	bar	4.70
ORC nominal condenser pressure	bar	4.60
ORC nominal thermal input	kW	23905.4
Turbine nominal mechanical power	kW	2491.3
Turbine nominal electric power	kW	2391.6
Pump nominal mechanical power	kW	189.4
ORC nominal net power	kW	2185.1
ORC nominal efficiency	-	9.1%
Heat exchangers total area	m^2	8297
Evaporator to Turbine pipe diameter	mm	500
Turbine to Condenser pipe diameter	mm	450
Condenser to Pump pipe diameter	mm	300
Pump to Evaporator pipe diameter	mm	300

482 7. Conclusions

483 A promising robust design optimization strategy based on two nested
484 Bayesian kriging surrogates with an expected improvement infill approach
485 has been successfully applied to an ORC for geothermal applications, af-
486 fected both by epistemic and aleatory uncertainty. The first comes from the
487 lack of information about the geothermal source and it is considered as the
488 outcome of the interaction of the mass flow rate of the geothermal brine \dot{m}_{geo} ,
489 the temperature of the geothermal brine T_{geo} , and the heat capacity of the
490 geothermal brine c_{geo} ; on the other hand, the aleatory uncertainty is due to
491 the yearly variation of the cooling water temperature at the condenser T_{cd} .
492 Both these uncertainties can lead to an economic risk involving the whole
493 geothermal project.

494 Before the RDO, a preliminary global sensitivity analysis has been carried
495 out to evaluate the effect of the uncertain design parameters on the response

496 of the system; it turns out that the the most influential parameters are T_{geo} ,
497 \dot{m}_{geo} and T_{cd} , while c_{geo} can be neglected. These results are used to reduce
498 the number of optimization parameters that are considered in the RDO of
499 the ORC.

500 From the analysis of the Pareto front, it comes out that a unique opti-
501 mum solution does not exist and different compromise solutions among the
502 cost functions are possible. Among them, the one offering the best trade-off
503 among all optimization targets is selected. This optimal solution obtained
504 with the RDO methodology is then compared with the optimal solutions
505 from the deterministic optimization, which are always outperformed. In par-
506 ticular, the best RDO solution wins against the best deterministic optimum,
507 increasing the mean value of the PDF of the QoI (the power production) by
508 1.5%, while its standard deviation is reduced by 8.5% and the surface of the
509 heat exchangers by 34%.

510 Future work will focus on applying the present RDO methodology to more
511 complex ORC configurations (for instance, recuperative cycles, multilevel
512 cycles or systems with several pre-heaters in parallel), giving a focus also on
513 operational aspects like failure probability.

References

- [1] Bertani, R., Geothermal power generation in the world 2005–2010 update report, *Geothermics* 41 (2012) 1–29. doi:<https://doi.org/10.1016/j.geothermics.2011.10.001>.
- [2] Bertani, R., Geothermal power generation in the world 2010–2014 update report, *Geothermics* 60 (2016) 31–43. doi:<https://doi.org/10.1016/j.geothermics.2015.11.003>.
- [3] The International Renewable Energy Agency, Geothermal power: Technology brief, Tech. Rep. ISBN 978-92-9260-036-5 (PDF), IRENA, Abu Dhabi (Sep. 2017).
- [4] Tartiere, T., Astolfi, M., A World Overview of the Organic Rankine Cycle Market, *Energy Procedia* 129 (2017) 2–9. doi:[10.1016/j.egypro.2017.09.159](https://doi.org/10.1016/j.egypro.2017.09.159).
- [5] Barr, H., Grant, M.A., *Coping With Uncertainty in Geothermal Field Development*, Auckland University, 1984.

- [6] American Institute of Aeronautics and Astronautics (Ed.), Guide for the Verification and Validation of Computational Fluid Dynamics Simulations, 1998.
- [7] American Society of Mechanical Engineers, Standard for Verification and Validation in Computational Fluid Dynamics and Heat Transfer, ASME.
- [8] A. Robertson-Tait, R. Henneberger, S. K. Sanyal, Managing Geothermal Resource Risk - Experience From the United States, Karlsruhe, Germany, 2008, p. 9.
- [9] The World Bank - Energy Sector Management Assistance Program, Geothermal Handbook: Planning and Financing Power Generation, Tech. rep. (2012).
- [10] S. K. Sanyal, J. B. Koenig, Resource risk and its mitigation for the financing of geothermal projects, in: Transactions International Geothermal Energy Conference, Florence, Italy, 1995, pp. 2911–2915.
- [11] S. Sanyal, J. Morrow, Quantification of geothermal resource risk - A practical perspective, Transactions - Geothermal Resources Council 34 (2010) 117–122.
- [12] Macchi, E., Astolfi, M., Organic Rankine Cycle Power Systems, Elsevier, 2017.
- [13] Y. Dai, J. Wang, L. Gao, Parametric optimization and comparative study of organic Rankine cycle (ORC) for low grade waste heat recovery, Energy Conversion and Management 50 (3) (2009) 576–582. doi:10.1016/j.enconman.2008.10.018.
- [14] Z. Q. Wang, N. J. Zhou, J. Guo, X. Y. Wang, Fluid selection and parametric optimization of organic Rankine cycle using low temperature waste heat, Energy 40 (1) (2012) 107–115. doi:10.1016/j.energy.2012.02.022.
- [15] J. Wang, Z. Yan, M. Wang, S. Ma, Y. Dai, Thermodynamic analysis and optimization of an (organic Rankine cycle) ORC using low grade heat source, Energy 49 (2013) 356–365. doi:10.1016/j.energy.2012.11.009.

- [16] J. Wang, Z. Yan, M. Wang, M. Li, Y. Dai, Multi-objective optimization of an organic Rankine cycle (ORC) for low grade waste heat recovery using evolutionary algorithm, *Energy Conversion and Management* 71 (2013) 146–158. doi:10.1016/j.enconman.2013.03.028.
- [17] H. Xi, M. Li, C. Xu, Y. He, Parametric optimization of regenerative organic Rankine cycle (ORC) for low grade waste heat recovery using genetic algorithm, *Energy* 58 (2013) 473–482. doi:10.1016/j.energy.2013.06.039.
- [18] L. Pierobon, T. Nguyen, U. Larsen, F. Haglind, B. Elmegaard, Multi-objective optimization of organic Rankine cycles for waste heat recovery: Application in an offshore platform, *Energy* 58 (2013) 538–549. doi:10.1016/j.energy.2013.05.039.
- [19] J. G. Andreasen, U. Larsen, T. Knudsen, L. Pierobon, F. Haglind, Selection and optimization of pure and mixed working fluids for low grade heat utilization using organic Rankine cycles, *Energy* 73 (2014) 204–213. doi:10.1016/j.energy.2014.06.012.
- [20] S. Lecompte, H. Huisseune, M. van den Broek, S. De Schampheleire, M. De Paepe, Part load based thermo-economic optimization of the Organic Rankine Cycle (ORC) applied to a combined heat and power (CHP) system, *Applied Energy* 111 (2013) 871–881. doi:10.1016/j.apenergy.2013.06.043.
- [21] G. Manente, A. Toffolo, A. Lazzaretto, M. Paci, An Organic Rankine Cycle off-design model for the search of the optimal control strategy, *Energy* 58 (2013) 97–106. doi:10.1016/j.energy.2012.12.035.
- [22] L. Pierobon, E. Casati, F. Casella, F. Haglind, P. Colonna, Design methodology for flexible energy conversion systems accounting for dynamic performance, *Energy* 68 (2014) 667–679. doi:10.1016/j.energy.2014.03.010.
- [23] D. Maraver, J. Royo, V. Lemort, S. Quoilin, Systematic optimization of subcritical and transcritical organic Rankine cycles (ORCs) constrained by technical parameters in multiple applications, *Applied Energy* 117 (2014) 11–29. doi:10.1016/j.apenergy.2013.11.076.

- [24] D. Walraven, B. Laenen, W. D'haeseleer, Optimum configuration of shell-and-tube heat exchangers for the use in low-temperature organic Rankine cycles, *Energy Conversion and Management* 83 (2014) 177–187. doi:10.1016/j.enconman.2014.03.066.
- [25] U. Larsen, O. Sigthorsson, F. Haglind, A comparison of advanced heat recovery power cycles in a combined cycle for large ships, *Energy* 74 (2014) 260–268. doi:10.1016/j.energy.2014.06.096.
- [26] D. Walraven, B. Laenen, W. D'haeseleer, Economic system optimization of air-cooled organic Rankine cycles powered by low-temperature geothermal heat sources, *Energy* 80 (2015) 104–113. doi:10.1016/j.energy.2014.11.048.
- [27] E. Martelli, F. Capra, S. Consonni, Numerical optimization of Combined Heat and Power Organic Rankine Cycles – Part A: Design optimization, *Energy* 90 (2015) 310–328. doi:10.1016/j.energy.2015.06.111.
- [28] F. Capra, E. Martelli, Numerical optimization of combined heat and power Organic Rankine Cycles – Part B: Simultaneous design & part-load optimization, *Energy* 90 (2015) 329–343. doi:10.1016/j.energy.2015.06.113.
- [29] Beyer, H. G., Sendhoff, B., Robust optimization – A comprehensive survey, *Computer Methods in Applied Mechanics and Engineering* 196 (33) (2007) 3190–3218. doi:10.1016/j.cma.2007.03.003.
- [30] Taguchi, G., *System of experimental design: engineering methods to optimize quality and minimize costs*, UNIPUB/Kraus International Publications, 1987.
- [31] M. Maliki, B. Sudret, J. Bourinet, B. Guillaume, Quantile-based optimization under uncertainties using adaptive Kriging surrogate models, *Structural and Multidisciplinary Optimization* (May 2016). doi:10.1007/s00158-016-1504-4.
- [32] L. Cook, J. Jarrett, Horsetail matching: a flexible approach to optimization under uncertainty (May 2017). doi:10.17863/CAM.9396.
- [33] E. A. Bufi, S. M. Camporeale, P. Cinnella, Robust optimization of an Organic Rankine Cycle for heavy duty engine waste

- heat recovery, *Energy Procedia* 129 (Supplement C) (2017) 66–73. doi:10.1016/j.egypro.2017.09.190.
- [34] F. Fontaine, Design and Simulation Model of Medium Scale Organic Rankine Cycles - Validation on Waste Heat Recovery Plant and Case Studies, MS Thesis, University of Liege (Sept. 2018).
- [35] I. H. Bell, S. Quoilin, E. Georges, J. E. Braun, E. A. Groll, W. T. Horton, V. Lemort, A generalized moving-boundary algorithm to predict the heat transfer rate of counterflow heat exchangers for any phase configuration, *Applied Thermal Engineering* 79 (2015) 192 – 201. doi:<https://doi.org/10.1016/j.applthermaleng.2014.12.028>.
- [36] F. P. Incropera, D. P. DeWitt, T. L. Bergman, A. S. Lavine, *Fundamentals of Heat and Mass Transfer*, 6th Edition, Wiley, 2007, google-Books-ID: _P9QAAAAMAAJ.
- [37] I. H. Bell, J. Wronski, S. Quoilin, V. Lemort, Pure and pseudo-pure fluid thermophysical property evaluation and the open-source thermophysical property library coolprop, *Industrial & Engineering Chemistry Research* 53 (6) (2014) 2498–2508. arXiv:<http://pubs.acs.org/doi/pdf/10.1021/ie4033999>, doi:10.1021/ie4033999.
- [38] J. A. Nelder, R. Mead, A simplex method for function minimization, *Comput. J.* 7 (1965) 308–313.
- [39] P. Virtanen, R. Gommers, T. E. Oliphant, M. Haberland, T. Reddy, D. Cournapeau, E. Burovski, P. Peterson, W. Weckesser, J. Bright, S. J. van der Walt, M. Brett, J. Wilson, K. Jarrod Millman, N. Mayorov, A. R. J. Nelson, E. Jones, R. Kern, E. Larson, C. Carey, Í. Polat, Y. Feng, E. W. Moore, J. Vand erPlas, D. Laxalde, J. Perktold, R. Cimrman, I. Henriksen, E. A. Quintero, C. R. Harris, A. M. Archibald, A. H. Ribeiro, F. Pedregosa, P. van Mulbregt, S. . . Contributors, *SciPy 1.0: Fundamental Algorithms for Scientific Computing in Python*, *Nature Methods* 17 (2020) 261–272. doi:<https://doi.org/10.1038/s41592-019-0686-2>.
- [40] C. F. Colebrook, C. M. White, G. I. Taylor, Experiments with fluid friction in roughened pipes, *Proceedings of the Royal Society of London*.

Series A - Mathematical and Physical Sciences 161 (906) (1937) 367–381.
doi:10.1098/rspa.1937.0150.

- [41] M. Powell, A view of algorithms for optimization without derivatives, *Mathematics TODAY* 43 (01 2007).
- [42] C. Vogt, D. Mottaghy, V. Rath, A. Wolf, R. Pechinig, C. Clauser, Quantifying Uncertainty in Geothermal Reservoir Modeling, *Proceedings World Geothermal Congress (2010)* 25–29.
- [43] A. Foerster, Analysis of borehole temperature data in the North-east German Basin: Continuous logs versus bottom-hole temperatures, *Petroleum Geoscience* 7 (2001) 241–254. doi:10.1144/petgeo.7.3.241.
- [44] Y. Lee, D. Deming, K. Chen, Heat flow and heat production in the Arkoma Basin and Oklahoma Platform, southeastern Oklahoma, *Journal of Geophysical Research* 101 (1996) 25387–25401. doi:10.1029/96JB02532.
- [45] H. J. Olsen, Geothermal reservoir assessment based on slim hole drilling, *Electric Power Research Institute*, 1993.
- [46] Ashrae, *Ashrae Handbook 2016: HVAC Systems and Equipment: SI Edition*, ASHRAE Handbook of Heating, Ventilating and Air-Conditioning Systems and Equipment SI, ASHRAE, 2016.
- [47] G. Fishman, *Monte Carlo - Concepts, Algorithms, and Applications*, Springer, 1996.
- [48] P. Cinnella, S. J. Hercus, Robust optimization of dense gas flows under uncertain operating conditions, *Computers & Fluids* 39 (10) (2010) 1893–1908. doi:10.1016/j.compfluid.2010.06.020.
- [49] W. N. Edeling, R. P. Dwight, P. Cinnella, Simplex-stochastic collocation method with improved scalability 310 301–328. doi:10.1016/j.jcp.2015.12.034.
- [50] K. Tang, P. M. Congedo, R. Abgrall, Adaptive surrogate modeling by ANOVA and sparse polynomial dimensional decomposition for global sensitivity analysis in fluids simulation, *Journal of Computational Physics* 314 (2015) 36.

- [51] A. Forrester, A. Sobester, A. Keane, *Engineering Design via Surrogate Modelling: A Practical Guide*, John Wiley & Sons, 2008.
- [52] C. E. Rasmussen, C. K. I. Williams, *Gaussian Processes for Machine Learning*, The MIT Press, Cambridge, Mass, 2006.
- [53] M. C. Kennedy, A. O’Hagan, Bayesian Calibration of Computer Models, *Journal of the Royal Statistical Society, Series B, Methodological* 63 (2000) 425–464.
- [54] C. K. Wikle, L. M. Berliner, A Bayesian tutorial for data assimilation, *Physica D: Nonlinear Phenomena* 230 (1) (2007) 1–16. doi:10.1016/j.physd.2006.09.017.
- [55] De Baar, J.H.S., *Stochastic Surrogates for Measurements and Computer Models of Fluids*, Ph.D. thesis (2014).
- [56] E. A. Bufi, P. Cinnella, Robust optimization of supersonic ORC nozzle guide vanes, *J. Phys.: Conf. Ser.* 821 (1) (2017) 012014. doi:10.1088/1742-6596/821/1/012014.
- [57] A. Serafino, B. Obert, H. Hagi, P. Cinnella, Assessment of an Innovative Technique for the Robust Optimization of Organic Rankine Cycles, *American Society of Mechanical Engineers Digital Collection*, 2019. doi:10.1115/GT2019-90170.
- [58] M. D. McKay, R. J. Beckman, W. J. Conover, Comparison of three methods for selecting values of input variables in the analysis of output from a computer code, *Technometrics* 21 (2) (1979) 239–245. arXiv:<https://doi.org/10.1080/00401706.1979.10489755>, doi:10.1080/00401706.1979.10489755.
- [59] K. Deb, A. Pratap, S. Agarwal, T. Meyarivan, A fast and elitist multiobjective genetic algorithm: NSGA-II 6 (2) 182–197. doi:10.1109/4235.996017.
- [60] R. Liu, A. B. Owen, Estimating mean dimensionality of analysis of variance decompositions, *Journal of the American Statistical Association* 101 (474) (2006) 712–721.

- [61] R. Ballester-Ripoll, E. G. Paredes, R. Pajarola, Sobol tensor trains for global sensitivity analysis, *Reliability Engineering and System Safety* 183 (2019) 311 – 322. doi:<https://doi.org/10.1016/j.ress.2018.11.007>.
- [62] I. Sobol, Global sensitivity indices for nonlinear mathematical models and their monte carlo estimates 55 (1) 271–280. doi:10.1016/S0378-4754(00)00270-6.