



HAL
open science

Measurement of low-activity uranium contamination by gamma-ray spectrometry for nuclear decommissioning

Nicolas Dufour, Jonathan Dumazert, Eric Barat, Guillaume Bertrand, Frédéric Carrel, Thomas Dautremer, Frédéric Lainé, Adrien Sari

► To cite this version:

Nicolas Dufour, Jonathan Dumazert, Eric Barat, Guillaume Bertrand, Frédéric Carrel, et al.. Measurement of low-activity uranium contamination by gamma-ray spectrometry for nuclear decommissioning. Nuclear Instruments and Methods in Physics Research Section A: Accelerators, Spectrometers, Detectors and Associated Equipment, 2020, 951, pp.162976. 10.1016/j.nima.2019.162976 . hal-03488632

HAL Id: hal-03488632

<https://hal.science/hal-03488632v1>

Submitted on 6 Jan 2022

HAL is a multi-disciplinary open access archive for the deposit and dissemination of scientific research documents, whether they are published or not. The documents may come from teaching and research institutions in France or abroad, or from public or private research centers.

L'archive ouverte pluridisciplinaire **HAL**, est destinée au dépôt et à la diffusion de documents scientifiques de niveau recherche, publiés ou non, émanant des établissements d'enseignement et de recherche français ou étrangers, des laboratoires publics ou privés.

Measurement of Low-Activity Uranium Contamination by Gamma-Ray Spectrometry for Nuclear Decommissioning

N. Dufour^{*1}, J. Dumazert¹, E. Barat², G. H. V. Bertrand¹, F. Carrel¹, T. Dautremer², F. Lainé¹, A. Sari¹

¹CEA, LIST, Laboratoire Capteurs et Architectures Electroniques, 91191 Gif-sur-Yvette, France.

²CEA, LIST, Laboratoire Modélisation et Simulations de Systèmes, 91191 Gif-sur-Yvette, France.

**nicolas.dufour3@cea.fr*

Abstract

Nuclear decommissioning takes place after dismantling, and consists of studying the possible presence of any residual contamination. To do so, every surface inside the facility must be radiologically characterized, and every contamination removed. In the case of an alpha contamination linked with a low gamma activity, using a High-Purity Germanium detector (HPGe) combined with hypothesis tests on the count statistics can be helpful to assess said contamination. Gamma-ray activity enables to determine the total contamination activity provided both are related, like in the case of an uranium-based contamination. Hypothesis tests determine the statistical power of the measurement, allowing decision making when dealing with countings below the detection limit. A representation of the tests results using Receiver Operating Characteristics (ROC) curves allow the user to select an appropriate time of measurement, true detection and false alarm rates, in accordance to the required specifications. This paper presents the feasibility study of such a method, applied to the detection of a low-activity gamma surface contamination of uranium on concrete, with varying enrichment levels.

I. Introduction

Nuclear decommissioning and dismantling is a process that occurs after a basic nuclear facility is closed [1]. Depending on the past operations conducted in the facility, different contaminations may be expected. Uranium-based contamination, in particular, emits three main signals: alpha particles [2], beta particles [3] and gamma rays [4]. Since all three come from the same decay chain, consequently, determining either activity can lead to the total contamination activity. Alpha spectroscopy and counting is greatly impaired due to rough surfaces leading to different source-detector distances, and the matrix stopping power when the contamination is not strictly a plane surface. Beta counting is sensitive to gamma background signal, coming from either the contamination or the environment. Moreover, at higher uranium enrichments, beta activity is reduced. In fact, the decay chain of uranium 235, when in secular equilibrium, has a low beta and gamma activity relative to the alpha activity, of a factor 10 to 100 depending on the enrichment level. Gamma-ray spectrometry can be used, since gamma rays are weakly affected by variations in source-detector distance.

Using high-resolution gamma-ray detectors, such as the High-Purity Germanium detector (HPGe), we can measure the uranium gamma activity. A high resolution is needed to select narrow regions of interest, associated with gamma peaks of specific uranium radionuclides. Indeed, we can consider three isotopes: uranium 234, 235 and 238, each with specific gamma emissions. Furthermore, in a concrete environment, the signal-to-noise ratio is high, implying high detection limits. This is true when the measured signal originates from a low activity, which is the case in our uranium contamination context, especially with high enrichment levels.

To counter the limitation of standard decision procedures, specific hypothesis tests are used. These give access to a calculation of the statistical power of the measurement, allowing the user to know the confidence interval expressed as true positives or false positives (also called true detections and false alarms). Using simulated and experimental data, we tested the method. The experimental measurements were conducted in a representative basic nuclear facility. We chose as our surface contamination limit for a low activity, close to the background signal:

$$A = 2000 \text{ Bq/m}^2 (\alpha), \Omega = 2\pi \text{ sr}$$

Where A is the activity and Ω is the solid angle of emission of the source. In this paper, we describe the method and simulations conducted in order to detect low-activity surface gamma contamination using an HPGe spectrometry chain and dedicated hypothesis tests.

54 II. In-situ gamma spectrometry for nuclear decommissioning and dismantling

55
56 The principles of gamma spectrometry have already been well defined in dedicated literature [5]. There are two
57 main detectors used for gamma spectrometry: scintillators and semi-conductors. The difference in performance
58 between these two detectors lies in the underlying physics of signal generation. Scintillation detectors generate a signal
59 with the scintillation photons converted to electrical current using a photodetector such as a photomultiplier or a
60 photodiode, whereas semi-conductors directly collect the charges created by the photon-matter interaction.

61 Scintillation pulses are short in comparison with semi-conductor ones, meaning scintillators are well suited to
62 handle high-rate counting. They can be produced in large volumes, especially NaI and organic scintillators. On the
63 contrary, semi-conductors have generally a higher resolution than scintillators. Some semi-conductors like CdTe or
64 CdZnTe can be operated at room temperature, while germanium crystals are mostly operated cooled down in order to
65 improve the resolution [6]. These characteristics lead us to choose an HPGe detector for our study, allowing us to
66 define narrower regions of interest, which in result, lowers the minimal detectable activity.

67 Gamma spectrometry can be used to conduct radiological characterization operations in order to dismantle and/or
68 decommission nuclear facilities. Such operations can be conducted in a laboratory using samples taken from the site,
69 or measurements can be made directly on site [7]. For *in-situ* measurements, both scintillators and semi-conductors are
70 used, predominantly NaI scintillators and HPGe detectors, while for laboratory measurements on samples, high-
71 resolution detectors such as HPGe are preferred [8]. Depending on the expected activity, a calculation of the minimal
72 detectable activity (MDA) must be made prior of the *in-situ* measurements for either NaI or HPGe, either
73 experimentally or using Monte Carlo simulations [9]. Dedicated software have been developed to help the
74 characterization of complex geometries, for example, the In-Situ Object Counting System software [10]. It allows a
75 calibration of the detector without the need of additional sources, enabling gamma spectrometry in complex detection
76 geometries. Measurements conducted with ISOCS showed good agreement with measurements made in laboratory
77 [11]. When dealing with deep contaminations in concrete, the scattering of gamma rays can hinder the precise
78 localisation of the contamination. Methods using collimators can be employed to counter this effect [12], allowing a
79 better mapping of the contamination [13].

80 The method presented in this paper focuses on the application of a statistical approach to *in-situ* gamma
81 spectrometry measurements, in order to detect low-activity contaminations. Being a post-processing methodology, the
82 statistical approach can be complimentary to other measurements schemes including the use of passive collimators
83 [14] or Compton suppressing systems [15,16], which help reducing the inference from the scattered signal.

84

85 III. Source term, concrete background signal and alpha/gamma transfer function

86

87 A. Source term: uranium gamma peaks of interest

88

89 We use two decay chains to characterize the contamination, and then the mass of uranium present:

90

91 Decay chain U-238 :

92

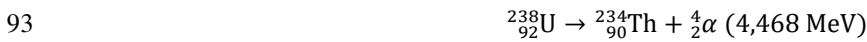

94

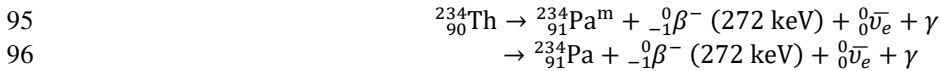

96

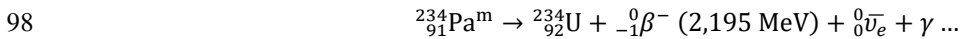

98

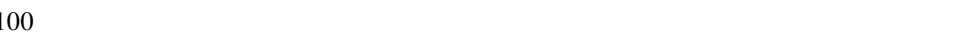

100

101 Decay chain U-235 :

102



104

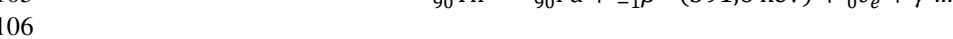

106

107 The major gamma rays studied are extracted from the nuclear database LARA and reported in table I [17].

108

109

110

Table I. Main gamma rays in ${}^{235}\text{U}/{}^{238}\text{U}$ decay chains

Energy (keV)	Emitter parent isotope	Decay chain	Daughter isotope emission rate per parent isotope decay
49.55(6)	U-238 (γ)	U-238	$6.97(26) \cdot 10^{-4}$ (U-238)
113.5(1)	U-238 (γ)	U-238	$1.74(47) \cdot 10^{-4}$ (U-238)
63.30(2)	Th-234 (γ)	U-238	$3.75(8) \cdot 10^{-2}$ (Th-234)
92.38(1)	Th-234 (γ)	U-238	$2.18(19) \cdot 10^{-2}$ (Th-234)
92.80(2)	Th-234 (γ)	U-238	$2.15(19) \cdot 10^{-2}$ (Th-234)
766.361(20)	Pa-234m (γ)	U-238	$3.23(4) \cdot 10^{-3}$ (Pa-234m)
1001.026(18)	Pa-234m (γ)	U-238	$8.47(8) \cdot 10^{-3}$ (Pa-234m)
109.19(7)	U-235 (γ)	U-235	$1.66(13) \cdot 10^{-2}$ (U-235)
143.767(3)	U-235 (γ)	U-235	$1.094(6) \cdot 10^{-1}$ (U-235)
163.356(3)	U-235 (γ)	U-235	$5.08(3) \cdot 10^{-2}$ (U-235)
185.720(4)	U-235 (γ)	U-235	$5.70(3) \cdot 10^{-1}$ (U-235)
202.12(1)	U-235 (γ)	U-235	$1.08(2) \cdot 10^{-2}$ (U-235)
205.316(4)	U-235 (γ)	U-235	$5.02(3) \cdot 10^{-2}$ (U-235)

111
112 The methodology to choose which gamma-rays are selected is based on the calculation of the Signal-to-Noise Ratio
113 (SNR):
114

$$SNR = \frac{N_{signal}}{\sigma_{signal}} = \frac{N_{signal}}{\sqrt{N_{total} + N_{BCKG}}} \quad (1)$$

115
116
117 With N_{signal} the net counting of the full energy peak, σ_{signal} the standard deviation of N_{signal} , N_{total} the total
118 counting of the gamma-ray energy, and N_{BCKG} the counting of the gamma-ray energy corresponding to the
119 background.

120
121 We want to maximise the SNR. Based on the variables involved in the SNR formula, we can either
122 increase N_{signal} , decrease N_{BCKG} , or do both. We cannot use the time of measurement to help, since we are
123 looking to minimise it so the total radiological characterization is the lowest possible.

124
125 To increase N_{signal} , we can:

- 126 Choose a gamma ray with a high emission intensity
- 127 Choose a gamma ray with an energy corresponding to the maximum efficiency of the HPGe

128
129 To decrease N_{BCKG} , we can:

- 130 Choose a gamma-ray far from the maximum background intensity

131
132 For example, if we consider the 185 keV gamma ray, it has an emission intensity of $5.7 \cdot 10^{-1}$, and is located inside
133 the maximum efficiency energy range of the HPGe detector. Both these variables are able to uneven the high
134 background counting rate, creating a contrast. This can be seen in Fig. 6, where the peak clearly emerges from the
135 background base line. For the 1001 keV gamma ray, it is located in an energy range where the background counting
136 rate is at its minimal, creating a visible contrast while having a low emission intensity and being far from the
137 highest detection efficiency energy range of the HPGe. This can be seen in Fig. 7.

138 We chose to take also into account the 143 keV gamma ray. Its energy is close to the 185 keV, but its emission
139 intensity is five times lower. Little contrast is made (cf. Fig. 6), meaning the SNR is defavorable. The same
140 reasoning was made for the choice of the 163 and the 205 keV gamma rays. We chose to keep these rays to study
141 their impact on the methodology presented here.

142
143 We will use the following gamma rays in order to quantify the uranium activity, based on our methodology and the
144 literature:

- 145 - 143.767 keV, 163.356 keV, 185.72 keV, 205.316 keV for ^{235}U [18]
- 146 - 1001.026 keV for ^{238}U [19]

147
148 X rays emitted by the uranium atoms are dismissed in this study, as they do not carry any isotopic information,
149 which consequently provides us no indication on the ^{235}U enrichment level.

150

151 *B. Background signal: concrete compound environment*

152
 153 The measurement usually needs to be carried out in a closed environment, surrounded by concrete from the walls,
 154 ceilings and floors. Henceforth, we have some prior knowledge of the shape, *i.e* normalised spectral distribution, of
 155 the background signal. In such an environment, indeed ^{40}K and $^{238}\text{U}/^{232}\text{Th}$ decay chains dominate the gamma-ray
 156 background activity [20,21].

157 In order to obtain the first experimental data, related to gamma rays inside a concrete closed environment, a
 158 measurement series was conducted inside representative nuclear basic facility premises. Acquired data are shown in
 159 Fig. 1. The detector used was an n-type HPGe, which has a relative efficiency of 35%, sold by ORTEC under the
 160 reference GMX35P4. The signal was shaped using a symmetrical trapezoidal filter, with a rise time of 2 μs and a
 161 plateau time equal to 4 μs . Spectra were acquired on 8192 channels, for an energy range lying between 0 and 3 MeV
 162 approximatively. Using a ^{137}Cs source, the energy calibration of the spectrometry chain was performed, prior to the
 163 measurements. No correction of the dead time is required, since it is under 1 % for both acquisitions. The acquisition
 164 time was taken equal to 3600 s.

165

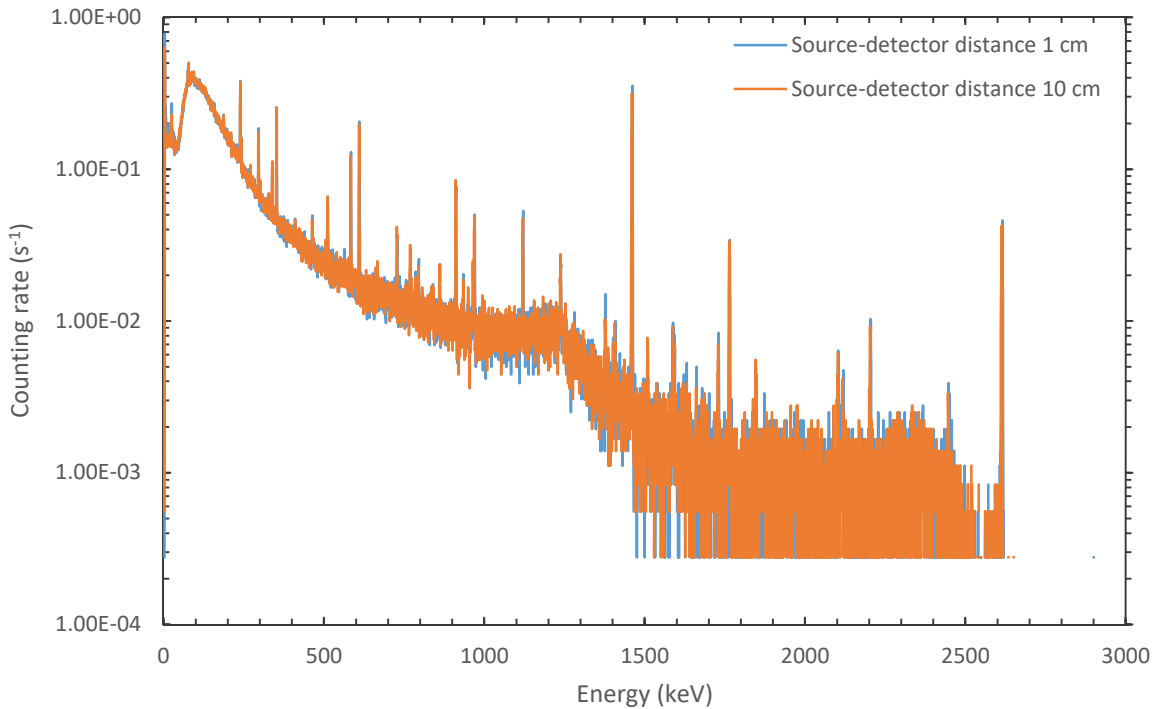

166

167 Fig. 1. Counting rate for a concrete closed environment as a function of energy and source-detector distance.

168

169 We found no significant difference between a background signal measurement with a distance of one centimetre
 170 and a distance of ten centimetres. From now on, we will choose to measure with a distance of one centimetre, in order
 171 to maximize the signal of interest. To ensure reliable results, a study of the variability of the background signal, inside
 172 the same concrete closed environment, is necessary. To do so, we introduce the following factor of merit, which is a
 173 relative deviation:

174

175

$$\epsilon[Z] = 100 \% \cdot \frac{m_{spotA}[Z] - m_{spotB}[Z]}{m_{spotB}[Z]} \quad (2)$$

176

177 With $\epsilon[Z]$, the relative deviation associated to a spectral region of interest Z , and m the counting rate
 178 associated to a spot. We test any difference in amplitude or shape, using different regions of interest. For amplitude
 179 variations, we use the full spectrum, non-normalized. For shape variations, we use regions where a gamma peak of
 180 interest is expected or not, normalized. We define those regions as:

181

- 182 - $Z_{TOT} = [0 - 3] \text{ MeV}$, region corresponding to the full spectrum

- 183 - $Z = [140 - 148], [160 - 166], [182 - 188], [202 - 208], [998 - 1004]$ keV, regions where a full energy
 184 peak of interest from uranium is expected
 185 - $W =]1004 - 3000[$ keV, regions where no full energy peak of interest is expected
 186

187 The choice of W was made on the assumption that even though there are gamma rays emitted inside this energy
 188 range by the uranium decay chain, the emission intensity is lower enough so that their impact is below the statistical
 189 variation of the background signal. We will demonstrate that it is the case for our uranium samples measurements
 190 presented in part IV. B.

191 Four measurements were conducted in four different spots, and we compared the acquired data. Table II and III
 192 present the factor of merit $\epsilon[Z]$ obtained from one-by-one comparison
 193

194 Table II. Relative deviations $\epsilon[Z]$ between non-normalized responses for different spots of measurements and regions of interest
 195

Spectral region	Spot 1 / Spot 2	Spot 3 / Spot 4
$Z = [0 - 3000 \text{ keV}]$	6.6 %	- 1.1 %
$Z = [140 - 148 \text{ keV}]$	6.2 %	- 2.5 %
$Z = [160 - 166 \text{ keV}]$	6.7 %	- 3.0 %
$Z = [182 - 188 \text{ keV}]$	6.9 %	- 2.2 %
$Z = [202 - 208 \text{ keV}]$	7.7 %	- 5.9 %
$Z = [998 - 1004 \text{ keV}]$	3.2 %	- 9.8 %

196 Table III. Relative deviations $\epsilon[Z]$ between normalized responses for different spots of measurements and regions of interest
 197
 198

Spectral region	Spot 1 / Spot 2	Spot 3 / Spot 4
$Z = [140 - 148 \text{ keV}]$	8.0 %	- 1.5 %
$Z = [160 - 166 \text{ keV}]$	6.7 %	- 2.3 %
$Z = [182 - 188 \text{ keV}]$	7.1 %	- 0.2 %
$Z = [202 - 208 \text{ keV}]$	9.4 %	- 5.8 %
$Z = [998 - 1004 \text{ keV}]$	6.8 %	6.9 %
$W =]1004 - 3000 \text{ keV}]$	7.1 %	0.5 %

199 We can conclude from tables II and III that the relative deviations are low. The empirical mean of the values is
 200 2.7% and 3.5% in table II and III respectively, while all values are below 10% in absolute value. The means are almost
 201 identical, as the extrema of the values, leading us to conclude that the variation in shape and in amplitude are of
 202 similar orders.
 203

204
 205 *C. Secular equilibrium and total uranium activity*
 206

207 For any enrichment level, the uranium activity of a contamination A_U can be simplified to the sum of the activities
 208 of its three main isotopes, A_{234U} , A_{235U} and A_{238U} :

$$209 \quad A_U = A_{234U} + A_{235U} + A_{238U} \quad (3)$$

$$A_{235U}(\gamma) = A_{235U} \cdot I_\gamma \quad (4)$$

210
 211 Where $A_{235U}(\gamma)$ is the gamma activity of 235U of a given gamma-ray and I_γ is the associated emission intensity.
 212 We will consider for this study that the ratio between two enrichment levels is the same for 235U and 234U , meaning
 213 that if we determine the enrichment level from 235U and 238U , we can approximate $A(^{234U})$. We can calculate the
 214 gamma activity for the aforementioned emissions, as a function of the enrichment level, for 2000 Bq (α), shown in
 215 Fig. 2. Throughout this document, we will use mass concentration (wt%) regarding the enrichment levels.
 216

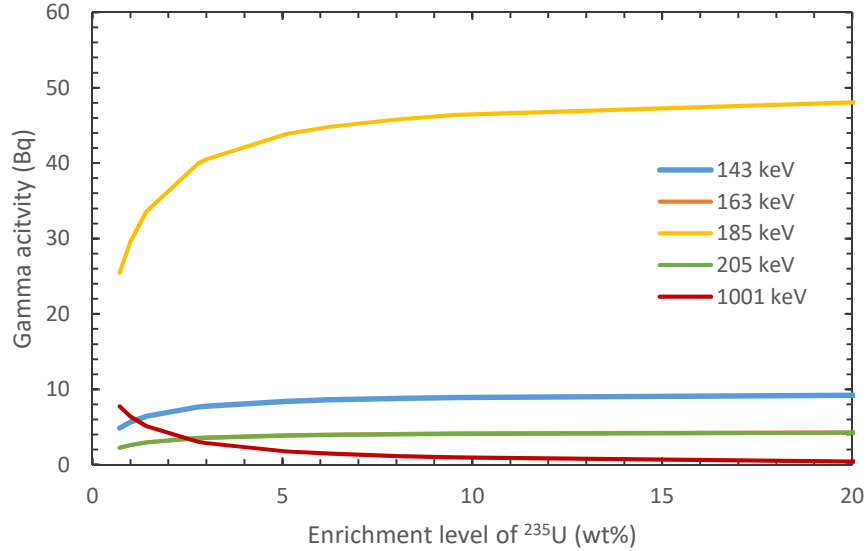

Fig. 2. Gamma activity of the main emission lines of uranium as a function of the enrichment level of ²³⁵U, total uranium activity of 2000 Bq (α). Note: 163 keV and 185 keV lines are superimposed.

We have then defined the gamma-ray source term associated to a total activity level. In order to estimate the expected counting rates *in situ*, we now need to introduce a numerical model of the detector and its response to the source term.

IV. Numerical model of the HPGe: modelling and experimental calibration

In order to acquire experimental data, associated to the measurement of uranium samples on a concrete support inside a concrete environment, we launched a series of acquisitions at the Photonic and Irradiation Activation System (*SAPHIR*), located in Saclay at the Atomic Energy Commission [22]. Using the spectrometry chain described in II. B., we placed uranium samples of various enrichment levels in front of a concrete block of one square meter, at a distance of one meter from the detector. No collimator or shielding were used in this study.

A. Numerical model of the detector

We modelled the detector and the series of acquisition using Monte Carlo N-Particles 6 transport code (MCNP6.1) [23]. For our application, we transported the gamma rays, the photons and the electrons created during gamma-matter interaction (mode PE). The modelling was limited to the detector (Germanium crystal and other diode components), the concrete block and the uranium sample. A 3D-visualisation is shown in Fig. 3, made using the visualisation software Vised [24], and table IV introduces the uranium sample used: enrichment level, dimensions, uranium mass and radiological activity.

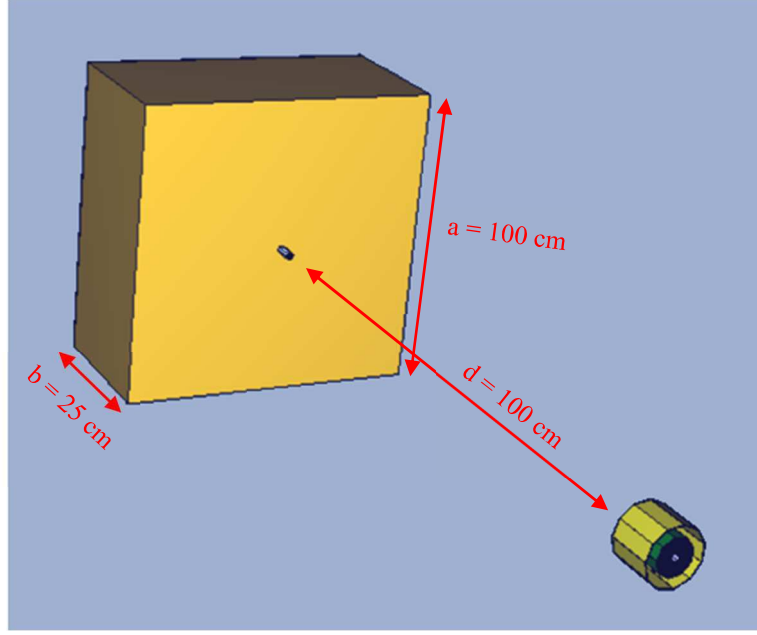

Fig. 3. 3D visualisation of the MCNP6.2 modelling of the experimental setup

Table IV. Characteristics of the samples measured in SAPHIR and modelled in MCNP6.2

U-235 enrichment level (wt%)	Diameter (mm) × height (mm)	U-238 mass (mg)	U-238 activity (Bq)	U-235 mass (mg)	U-235 activity (Bq)
0.7112 ± 0.0012	13.1×31.5	40764	505496	292	23359
1.416 ± 0.004	13.1×31.5	40474	501881	581	46508
2.785 ± 0.013	8.1×22.5	10899	135153	312	24980
5.111 ± 0.046	8.1×22.5	10639	131920	573	45842
6.222 ± 0.055	8.1×22.5	10514	130375	698	55807
9.548 ± 0.121	9.1×25.5	14506	179880	1513	122502

243
244
245
246

247

248 To compare the simulations and the experimental acquisitions, we must convert the macroscopic response of
249 MCNP6.2 into an estimated number of events. To do so, we use the activities mentioned in table IV, the gamma
250 emission intensities given by a database and a simulation of the detection efficiency. The chosen database for emission
251 intensities is Nucléide LARA [17], and the spectral response of the detector is given by the tally 8 of MCNP6.1, which
252 gives the number of depositions in an energy bin E_γ , normalized to the number of gamma rays emitted by the source.
253 In order to calculate the number of emitted gamma rays, we use $A_{235/238\text{U}}$ which is the uranium activity considered for
254 an enrichment level, and I_γ , the emission intensity of a specific gamma ray. Such response has been simulated using
255 the energy resolution of the detector. The unit of the tally F8 result, $Y(E_\gamma)$, is then homogenous to a detection
256 efficiency and will be used as such. This simulated detection efficiency also takes into account the energy resolution of
257 the detector, with a Gaussian broadening of the peaks.

258

259 We can calculate the simulated number of events as:

260

$$N_{MCNP}(E_\gamma) = Y(E_\gamma) \cdot A_{235/238\text{U}} \cdot I_\gamma \cdot t \quad (5)$$

261

262 With t the time of measurement, taken as 4500 s. The associated uncertainty is calculated using the propagation of
263 uncertainties [25] and gives the following result:

264

$$\frac{\Delta N_{MCNP}(E_\gamma)}{N_{MCNP}(E_\gamma)} = \sqrt{\left(\frac{\Delta Y(E_\gamma)}{Y(E_\gamma)}\right)^2 + \left(\frac{\Delta A_{235/238\text{U}}}{A_{235/238\text{U}}}\right)^2 + \left(\frac{\Delta I_\gamma}{I_\gamma}\right)^2 + \left(\frac{\Delta t}{t}\right)^2} \quad (6)$$

265

266 Fig. 4 and 5 show the simulated data for an enrichment level of 0.7wt% and 9.5wt%, such simulations were also
 267 conducted for the other enrichment levels, with the same degree of agreement. Experimental and simulated data are
 268 represented with their one standard deviation uncertainties.

269
 270

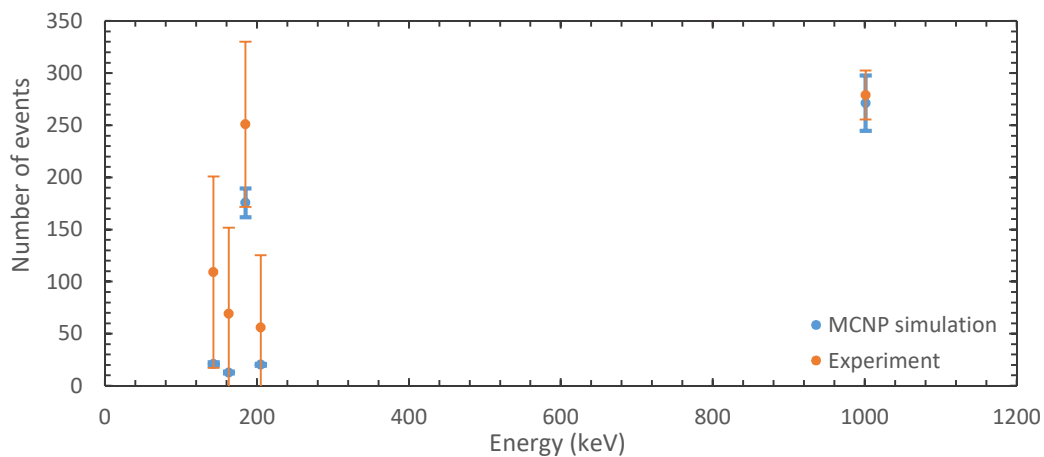

271 Fig. 4. Number of events expected with an MCNP simulation and experimentally acquired. Enrichment level of 0.7 wt% and
 272 time of measurement of 4500 s.
 273

274

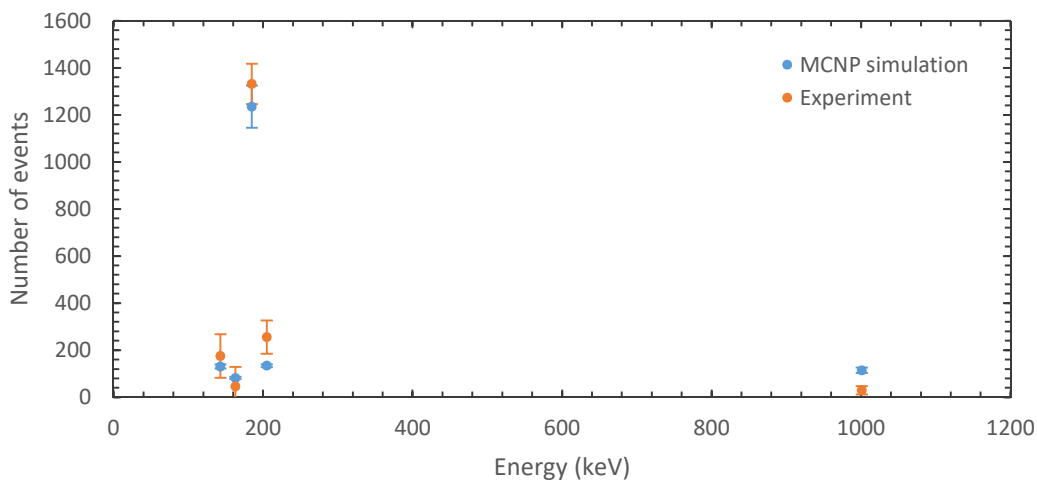

275 Fig. 5. Number of events expected with an MCNP simulation and experimentally acquired. Enrichment level of 9.5 wt% and
 276 time of measurement of 4500 s.
 277

278

279 *B. Uranium sample measurements in SAPHIR*

280

281 We acquired a background spectrum and different spectra using varying enrichment level samples. Measurements
 282 were performed following a sequential mode: 900 acquisitions of 5 seconds each are summed to form a spectrum of
 283 4500 seconds.

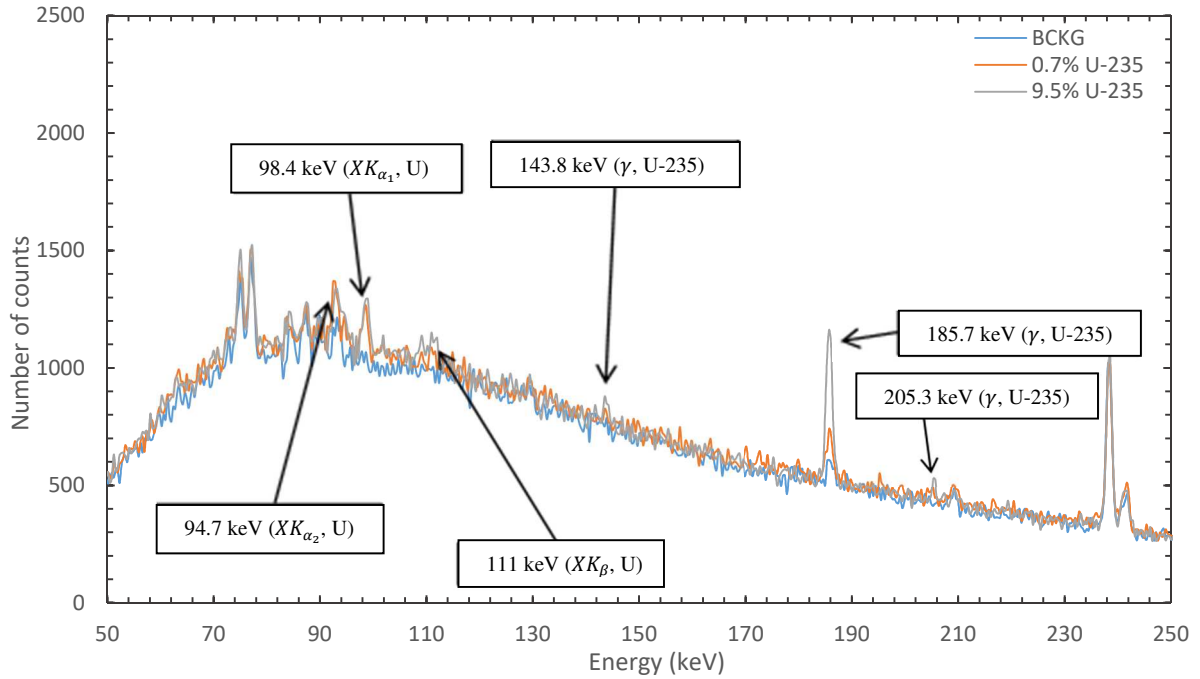

Fig. 6. [50-250] keV cumulated spectra associated to the background signal and the uranium samples of 0.7wt% and 9.5wt% enrichment levels.

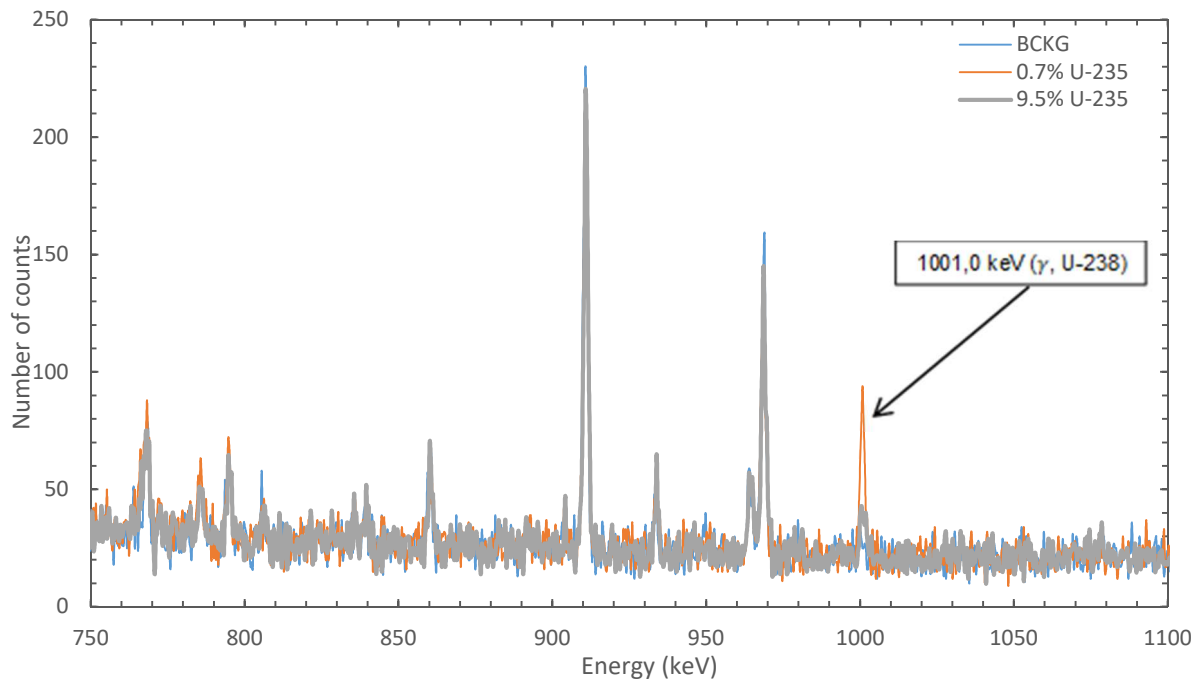

Fig. 7. [750-1100] keV cumulated spectra associated to the background signal and the uranium samples of 0.7wt% and 9.5wt% enrichment levels.

284
285
286
287

288
289
290
291
292

293 For the ^{238}U , the only gamma peak of interest is 1001.0 keV, emitted when $^{234}\text{U}^*$, belonging to the ^{238}U decay chain,
294 deexcites into its ground state. The spectral signature of ^{235}U is dominated by the 185.72 keV gamma ray. We mention
295 that the ^{226}Ra , from the ^{238}U decay chain, emits a gamma ray of 186.2 keV energy, which can be seen in the
296 background measurement.

297 Let $N_{EXP}(E_\gamma)$ be the net experimental response in counts, centred on the energy E_γ . We obtain N_{EXP} by subtracting
298 the background signal spectrum, N_{BCKG} , to the signal spectrum N_{S+BCKG} , and then by integrating the area under the
299 curve, in the associated region of interest. This is shown in equation 6. The response being an histogram with a
300 constant binning, we can simply sum the bins containing 99.7% of the total area (Gaussian approximation). We define
301 the associated one-sigma uncertainty in equation 7.

302

$$N_{EXP}(E_\gamma) = N_{S+BCKG}(E_\gamma) - N_{BCKG}(E_\gamma) \quad (7)$$

303

$$\Delta N_{exp}(E_\gamma) = \sqrt{N_{S+BCKG}(E_\gamma) + N_{BCKG}(E_\gamma)} \quad (8)$$

304

305 *Comparative study and first conclusions*

306

307 We calculated for all enrichment levels cited in table IV the experimental and simulated responses associated to the
 308 five gamma rays of interest for uranium detection: $E_\gamma \in \{143.8; 163.4; 185.7; 205.3; 1001.0\}$ keV. We start by
 309 observing that, for a low enrichment level, the simulated responses are much lower than the experimental background
 310 signal, for the [140 – 210] keV energy range: as an example, there is over an order of magnitude between the net
 311 signal at 185.7 keV and the background signal. This explains the large error bars of one standard deviation observed
 312 on Fig. 4.

313 For all data, we can see that there is an agreement between simulated and experimental data for ^{235}U gamma rays,
 314 within two standard deviations, $\pm 2\Delta N_{MCNP}(E_\gamma)$ and $\pm 2\Delta N_{exp}(E_\gamma)$ (Confidence interval of 95% under a Gaussian
 315 hypothesis). We also see an agreement for the ^{238}U data for low enrichment levels, but going into higher enrichment
 316 levels, experimental and simulated data match within three standard deviations. This result allows us to perform a
 317 proof of concept study using this simulation model.

318

319 V. Simulated response to the minimal activities to detect

320

321 We recall the assumed decommissioning criteria, taken as the minimal surface activity to detect:

322

$$A = 2000 \text{ Bq } (\alpha) / \text{m}^2, \Omega = 2\pi \text{ sr}$$

323 Apart from studying the expected minimal counting rate, we will also study the influence of the presence of
 324 another contamination, on an adjacent square meter to the measured one. We test for all gamma rays of interest and for
 325 five representative enrichment levels: natural enrichment, 1wt%, 3wt%, 8wt%, 20wt%. We chose a source-detector
 326 distance of one centimeter, mentioned before in II. B. Measurements at such a low distance to the surface forces the
 327 usage of physical protections for the detector, so as not to damage it while handling and/or moving it to another
 328 measurement spot.

329 Following the conclusions of III. C., we simulate the measurement with a tally F8, which gives us the detection
 330 efficiency, and we construct the expected counting rate (s^{-1}), called S , as

331

$$S(E_\gamma) = Y(E_\gamma) \cdot A_{235/238\text{U}} \cdot I_\gamma \quad (9)$$

332

333 depending on the studied gamma ray, whether it is from the ^{238}U decay chain, or the ^{235}U one. The simulated
 334 concrete block is $100 \times 100 \times 25 \text{ cm}^3$. A thickness of 25 centimeters has been chosen for a compromise between the
 335 calculation convergence and the accuracy of the concrete background signal [20].

336

337 A. Centred contamination: one centimetre, 2000 Bq (α) / m^2

338

339 In this first configuration, the 2000 Bq activity is homogeneously spread on the total concrete surface. The symmetry
 340 axis of the diode intersects the emitting plan at the center of the concrete surface. We present the geometry diagram on
 341 Fig. 8.

342 In table V, we present the values of $S(185.7 \text{ keV})$ and $S(1001.0 \text{ keV})$, for the considered enrichment levels of
 343 ^{235}U . The two responses change, naturally, in the opposite direction when the enrichment increases, since they are the
 344 main signatures of the two decay chains.

345

346

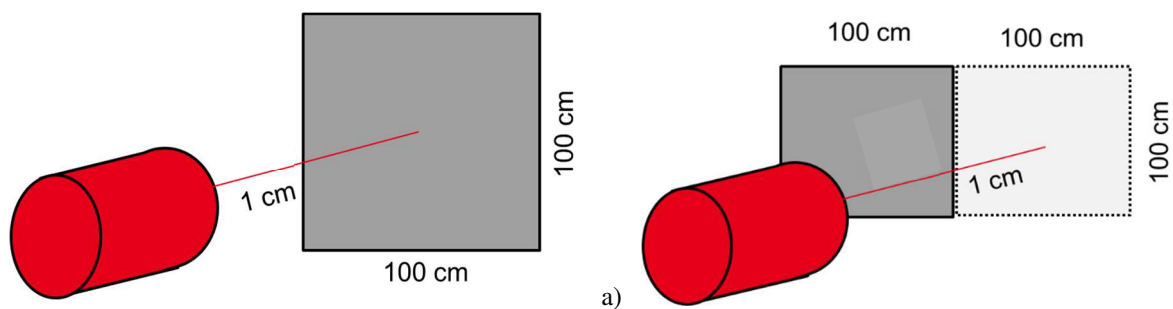

Fig. 8. Simulation geometry diagram for the study of an homogenous surface contamination on one square meter, a) detector centred, b) detector off-centred

Table V. Evolution of the response $S(185.7 \text{ keV})$ and $S(1001.0 \text{ keV})$ as a function of the enrichment level. Centred contamination

Enrichment level	Gamma-ray energy	Detector centred
Natural enrichment	185.7 keV	$0.178 \pm 0.018 \text{ s}^{-1}$
	1001.0 keV	$0.014 \pm 0.0014 \text{ s}^{-1}$
1 wt%	185.7 keV	$0.20 \pm 0.02 \text{ s}^{-1}$
	1001.0 keV	$0.011 \pm 0.0010 \text{ s}^{-1}$
3 wt%	185.7 keV	$0.28 \pm 0.02 \text{ s}^{-1}$
	1001.0 keV	$0.005 \pm 0.0004 \text{ s}^{-1}$
8 wt%	185.7 keV	$0.32 \pm 0.04 \text{ s}^{-1}$
	1001.0 keV	$0.002 \pm 0.0002 \text{ s}^{-1}$
20 wt%	185.7 keV	$0.34 \pm 0.04 \text{ s}^{-1}$
	1001.0 keV	$7.8 \cdot 10^{-4} \pm 8.10^{-5} \text{ s}^{-1}$

B. Adjacent contamination: one centimetre, 2000 Bq (α) / m^2

In this configuration, we study the impact of the presence of an adjacent contamination. In this case, the contamination is adjacent to the original contamination surface, see Figure 8. b. The goal is to quantify the impact on the measurement of an adjacent surface; in other words, the spatial resolution of the detection method.

Table V and VI present the values of $S(185.7 \text{ keV})$ and $S(1001.0 \text{ keV})$ respectively, for the considered enrichment levels of ^{235}U . Comparing the data in tables V and VI, we observe that the decentring of the detector from the contamination leads to an interference of about $7 \pm 1 \%$ of the measured contamination. This result confirms that the influence of an activity-equivalent adjacent contamination is limited and allow us not to use a collimator. However, in the case of a high adjacent contamination or close storage of nuclear waste, a collimator may be needed. The influence of such contaminations is an outlook for future work.

Table VI. Evolution of the response $S(185.7 \text{ keV})$ as a function of the enrichment level. Off-centred detector

Enrichment level	Gamma-ray energy	Off-centred detector
Natural enrichment	185.7 keV	$0.0128 \pm 0.0012 \text{ s}^{-1}$
	1001.0 keV	$1.0 \cdot 10^{-3} \pm 1 \cdot 10^{-4} \text{ s}^{-1}$
1 wt%	185.7 keV	$0.0147 \pm 0.0014 \text{ s}^{-1}$
	1001.0 keV	$8.2 \cdot 10^{-4} \pm 8 \cdot 10^{-5} \text{ s}^{-1}$
3 wt%	185.7 keV	$0.020 \pm 0.002 \text{ s}^{-1}$
	1001.0 keV	$3.8 \cdot 10^{-4} \pm 4 \cdot 10^{-5} \text{ s}^{-1}$
8 wt%	185.7 keV	$0.022 \pm 0.002 \text{ s}^{-1}$
	1001.0 keV	$1.5 \cdot 10^{-4} \pm 1.4 \cdot 10^{-5} \text{ s}^{-1}$
20 wt%	185.7 keV	$0.024 \pm 0.002 \text{ s}^{-1}$
	1001.0 keV	$5.4 \cdot 10^{-5} \pm 6 \cdot 10^{-6} \text{ s}^{-1}$

We have defined the source term of a surface uranium contamination, and the background associated to a measurement conducted in a concrete facility. We can now generate representative spectra in order to evaluate the performances of different hypothesis tests, without having to acquire a large number of measurements.

374
375 VI. Representative spectra and hypothesis tests
376
377 This section is dedicated to the basic description of hypothesis tests [26] used to detect the gamma ray signature of
378 ^{235}U and ^{238}U inside a concrete compound environment. The hypothesis test aim is to decide whether, for a given
379 observation time:
380
381 - The detector response is due only to the background signal (Null hypothesis, noted H_0)
382 - The response reveals the presence of an additional ^{235}U or ^{238}U signal (Alternate hypothesis, noted H_1)
383
384 The conditions to accept H_1 govern, in a given measurement time, the best compromise between False Alarm Rate
385 (FAR) and True Detection Rate (TDR). Given that the measurement time is a parameter, we start by describing the
386 principle of a representative spectrum generator, with varying measurement time. We then introduce the three
387 hypothesis tests, which performances have been studied via simulations.
388
389 A. Representative spectrum generation
390
391 In order to estimate the performances of a given hypothesis test as applied to the reconstitution of a measurement
392 of time t , we need to construct, at least, two spectra representing respectively the background signal and the addition
393 of the background signal with the uranium signal.
394 We use, as a background signal reference, the spectral response between [0 – 3] MeV acquired in a representative
395 nuclear basic facility, shown in II. B. A background signal measurement will be obtained from a random draw
396 following a Poisson law [26], where the density of probability is identified to the measured background signal
397 spectrum. A signal measurement will be a random draw following a Poisson law, where the density of probability is
398 identified to the sum of the background signal spectrum and the simulated response of the detector, shown in IV. A.
399 To better simulate the spectra, we will use a Gaussian Energy Broadening (GEB) card on MCNP. The input
400 parameters are $a = 0.0007$ MeV and $b = 0.0011$ MeV $^{\frac{1}{2}}$ for a simulated Full Width at Half Maximum $LTMH =$
401 $f(\sqrt{E_\gamma}) = a + b\sqrt{E_\gamma}$ [5].
402 In order to simulate different measurement times, we created a spectrum generator, where the reference counting
403 rates are multiplied with an input time, and the final value is a random draw of a Poisson law where the parameter is
404 the product described before. We generate N spectra for background signal only and N spectra for background signal
405 plus uranium signal, on which the tests will be based. We used $N = 10000$, giving 20000 spectra in total.
406
407 B. Hypothesis tests
408
409 The fact that we can use physics models to simulate the gamma source term associated to a uranium contamination
410 (II. A. and C.), and that we obtain multichannels spectra from acquisitions, allow an *a priori* modelling of the H_1
411 hypothesis, and so the usage of Bayesian tests [27]. Such a usage, however, is left as an outlook of this paper, to focus
412 on frequentist tests. Now, we will present some characteristics associated to hypothesis tests before introducing the
413 ones used in this study. Other usage of hypothesis tests are described in the literature [28].
414 A hypothesis test is said absolute when it is sensitive to any variation of counting rate on the associated regions of
415 interest. Such tests are vulnerable to any variations in amplitude of the background signal. Relative tests, on the
416 contrary, are only affected by a difference in shape of the regions of interest, making them suited in cases of a
417 variation in background signal intensity. We also need to consider the laterality of the hypothesis tests. The conformity
418 of the data to the null hypothesis is given by the p-value. P-values are calculated and compared to a rejection
419 threshold, called the alpha level (α). In a bilateral test, the p-value is rejected when its modulus is superior to α . In a
420 unilateral test, the p-value is rejected if the p-value is superior to α . It is then possible to discriminate a significant
421 increase in the regions of interest from a significant decrease, providing the latter has a physical interpretation.
422 Three hypothesis tests are presented and their principles explained. We used the Kolmogorov-Smirnov (KS) test
423 [29], a test based on the Cumulative function of a Negative Binomial law (CNB) [30] and a test based on the
424 Cumulative function of a Beta Binomial law (CBB) [31].
425
426 *Kolmogorov-Smirnov test (KS)*
427
428 The KS test is the classic relative test in literature, to detect a change in statistical distribution (shape of the
429 spectrum). This test enables to determine whether two statistical samples, in this case the radiological background and
430 a signal measurement, are identically distributed. The counting data, or number of counts, associated to the reference

431 background spectrum, noted $m_{ref}[E_\gamma]$, and to the measured signal, noted $m_{test}[E_\gamma]$, are classified in a histogram with
 432 regular energy bins $E_\gamma \in [0 - 3]\text{MeV}$. We calculate the empirical normalised cumulative functions $c_{ref}[E_\gamma]$ for the
 433 reference background spectrum and $c_{test}[E_\gamma]$ for the measured signal of the two data sets:

$$\forall E_\gamma \in [0; 3 \text{ MeV}], c_{ref}[E_\gamma] = \frac{\sum_{j=0}^{E_\gamma} m_{ref}[j]}{\sum_{j=0}^{3 \text{ MeV}} m_{ref}[j]} \quad (10)$$

$$\forall E_\gamma \in [0; 3 \text{ MeV}], c_{test}[E_\gamma] = \frac{\sum_{j=0}^{E_\gamma} m_{test}[j]}{\sum_{j=0}^{3 \text{ MeV}} m_{test}[j]} \quad (11)$$

434
 435 The p-value is given by:
 436

$$p = \max_{0 \leq E_\gamma \leq 3 \text{ MeV}} |c_{test}[E_\gamma] - c_{ref}[E_\gamma]| \quad (12)$$

437
 438 For a fixed α level, the KS hypothesis test reads:
 439 If $p > \alpha$, the H_0 hypothesis is rejected and a contamination is detected.
 440 Else, H_0 is accepted.

441
 442 The KS test is bilateral, meaning it is sensitive to any variation to the spectrum shape. We can expect that the
 443 compromise between the True Detection Rate (TDR) and the False Alarm Rate (FAR) is inferior to the one a unilateral
 444 test can give. This is why we now introduce a unilateral hypothesis test designed to discriminate any increase in the
 445 regions of interest.

446
 447 *Test on the Cumulative function of a Negative Binomial law (CNB)*
 448

449 We introduce an absolute and unilateral test, able to differentiate the acquisition times between the reference
 450 period (T_{ref}) and the test period (T_{test}). This test is simple in the sense that it only requires a total counting in both the
 451 regions of interest of ^{235}U and the region of interest of ^{238}U :
 452

$$Z = [140 - 148] \cup [160 - 166] \cup [182 - 188] \cup [202 - 208] \cup [998 - 1004] \text{ keV} \quad (13)$$

453
 454 The cumulative function is built under the H_0 hypothesis of an identical counting intensity between the two
 455 acquisitions. Let $m_{ref}[Z]$ be the associated counting of the reference background signal and $\rho[Z]$ the associated
 456 counting rate. The counting $m_{ref}[Z]$ is supposed to follow a Poisson law under the H_0 hypothesis, while its parameter
 457 $\rho[Z]$ is supposed to follow a gamma law of parameters $(a; b)$. The parameters $(a; b)$ are set to represent the absence
 458 of any inference on the counting intensity, with values $a = 0.5$ and $b = 0$. [32]

459 Henceforth, the *a posteriori* law of $\rho[Z]$ knowing $m_{ref}[Z]$ is a gamma law of parameters $(a + m_{ref}[Z]; b +$
 460 $T_{ref})$, and the posterior predictive law of $m_{test}[Z]$ knowing $m_{ref}[Z]$ is a negative binomial law of parameters
 461 $(\frac{T_{test}}{b + T_{ref} + T_{test}}; r = a + m_{ref}[Z])$. The cumulative function $C[Z]$, associated to this negative binomial law, is given by:

$$C[Z] = 1 - I_p(m_{test}[Z], r) \quad (14)$$

462
 463 Where I_p is the regularized incomplete beta function of parameters $m_{test}[Z]$ and r . The p-value is then defined as:
 464
 465

$$p = 1 - C[Z] \quad (15)$$

466
 467 For a fixed α level, the CNB hypothesis test is:
 468 If $p > \alpha$, the H_0 hypothesis is rejected and a contamination is detected.
 469 Else, H_0 is accepted.

470
 471 The CNB test is by construction sensitive to any variation in background signal intensity. Now we showed in II. B.
 472 that the background intensity can vary from a spot to another, which lead us to introduce a more sophisticated test with
 473 respect to background signal variation.

474

475 *Test on the Cumulative function of a Beta Binomial law (CBB)*

476
 477 Finally, we introduce a relative and unilateral test, relying on a measurement during a time T_{ref} and a signal
 478 measurement during a time T_{test} . The test uses the same regions of interest Z described for the CNB test, but also
 479 another region of interest, where no signal is expected, named control region. We define such region as:
 480

$$W =]1004 - 3000] \text{ keV} \quad (16)$$

481
 482 We excluded the interval $[0 - 140[$ keV because of X-ray and low-energy gamma signals, especially the ones
 483 corresponding to uranium.

484 Using the same notations as before, we introduce $m_{ref}[W]$, the counting in the control region of the background
 485 signal, and $m_{test}[W]$, the counting in the control region of the measured signal. The CBB test relies on the
 486 introduction of a random variable ρ , distributed as a beta law of parameters $(a ; b)$. We choose $a = 0.5$ and $b = 0.5$,
 487 corresponding to the absence of any prior knowledge of ρ [33]. The counting $m_{ref}[Z]$, during a measurement time
 488 T_{ref} on the region of interest Z is supposed to follow a binomial law of parameters $(m_{ref}[Z] + m_{ref}[W] ; \rho)$. The a
 489 *posteriori* law of ρ , knowing $m_{ref}[Z]$ and $m_{ref}[W]$, is then a beta law of parameters $(a + m_{ref}[Z] ; b + m_{ref}[W])$.

490 Under the H_0 hypothesis, the $m_{test}[Z]$ counting associated to the tested spectrum is distributed following a
 491 binomial law of parameter ρ . The predictive posterior law of $m_{test}[Z]$ knowing $m_{ref}[Z]$, $m_{ref}[W]$ and $m_{test}[W]$, is a
 492 beta binomial law with a number of draws $k_{test} = m_{test}[Z] + m_{test}[W]$ and parameters $(a + m_{ref}[Z] ; b +$
 493 $m_{ref}[W])$. Finally, the cumulative function associated to this law is expressed as:

$$C[Z, W] = \frac{B(a + m_{ref}[Z] + m_{test}[Z] + 1, b + m_{ref}[W] + m_{test}[W] - 1) \cdot F_{k_2}(\vec{a}, \vec{b}, m_{ref}[Z])}{B(a + m_{ref}[Z], b + m_{ref}[W]) \cdot B(m_{test}[W], m_{test}[Z] + 2) \cdot (m_{test}[Z] + m_{test}[W] + 1)} \quad (17)$$

495
 496 Where B is the beta function and $F_{k_2}(\vec{a}, \vec{b}, m_{ref}[Z])$ is the generalised hypergeometric function ${}_3F_2$.

497
 498 For a fixed α level, the CBB hypothesis test reads:
 499 If $C[Z, W] < \alpha$, the H_0 hypothesis is rejected and a contamination is detected.
 500 Else, H_0 is accepted.

501
 502 A study of the control region $]1004-3000]$ keV was made in order to determine if there is a difference in measured
 503 background signal with and without a sample, and if this difference is statistically significant. To do so, we sum the
 504 spectrum in this area and compare it with the spectra with samples. The results are displayed in figure 9 below:

505
 506
 507

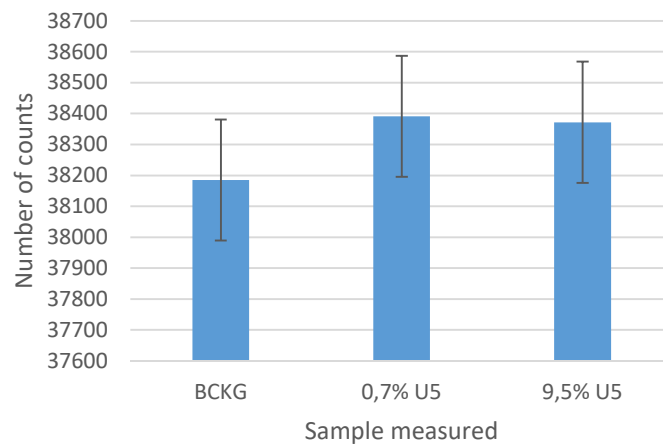

508
 509 Fig. 9. $]1004-3000]$ keV summed spectra associated to the background signal and the uranium samples of 0.7wt% and 9.5wt%
 510 enrichment levels. The uncertainty plotted is one standard deviation.

511
 512 We can see that all three measurements are under one standard deviation of the background-only measurement. We
 513 can conclude that the variation inside the control region is contained under the statistical variation of the background,
 514 thus it will have a minor impact on the CBB test.

515
516
517
518

VII. Receiver Operating Characteristic curves and integration time

519 The study of the statistical power of the tests presented in V. B. will be conducted, based on the generated
520 representative spectra described in paragraph V using Receiver Operating Characteristic (ROC) curves. Such curves
521 characterize the power of the tests described earlier. The generated spectra allow us to conduct the study without
522 having to acquire multiple spectra on site.

523
524
525

A. ROC curves

526 *Definition of the ROC curve*
527

528 A ROC curve is the performance graph of a complete detector chain, as a plot of the TDR as a function of the
529 FAR. An ideal detector would present a ROC curve passing through the following points: (0;0) - (0;1) - (1;1), while a
530 random response detector would show a plot consisting of a line crossing (0;0) and (1;1). Hence, in the absence of a
531 preset condition on an acceptable TDR or TDV, hypothesis tests power are evaluated on their ROC curves
532 approaching (0;1) [34].

533 ROC curves are constructed using a Monte Carlo method. We proceed to sample N random draws in the
534 background signal measurements, and the same number N in the constructed signal spectra from the representative
535 spectra generator described in V. A. The binary result of a test, 1 for a detection and 0 for a non-detection, depend on
536 the chosen alpha level. Therefore, the possible alpha level between 0 and 1 are given with a step of 10^{-6} . For each
537 value, we calculate the number of true positives in the presence of a contamination, corresponding to true detections
538 N_{TD} , and the number of false positives in the absence of a contamination, corresponding to false alarms N_{FA} . We
539 finally calculate, for each alpha level and each hypothesis test, the couple $\left(TDR = \frac{N_{TD}}{N}; FAR = \frac{N_{FA}}{N}\right)$, to which we
540 associate its repeatability one standard-deviation uncertainty:

541

$$\sigma(TDR) = \sqrt{\frac{1}{N} \cdot TDR \cdot (1 - TDR)}; \sigma(FAR) = \sqrt{\frac{1}{N} \cdot FAR \cdot (1 - FAR)} \quad (18)$$

542

543 The Monte Carlo method is carried out using MATLAB [35]. The number of iterations is $N = 10000$, so that
544 $\sigma(TDR)$ and $\sigma(FAR)$ do not exceed 0.5 %.

545

546 *Simulated configurations and Monte Carlo method setup*
547

548 ROC curves can be traced for different enrichment levels, different backgrounds signals, different measurement
549 times and different hypothesis tests. Moreover, we chose to study the impact of a variation in background amplitude,
550 but not in shape, on the detection performance. To do so, we multiplied to background signal spectra by a factor
551 between 1.01 and 1.1, corresponding to the average 1 % and 10 % maximum orders of variation found in II. B. We are
552 indeed looking to find the most effective test in the case of background signal stability, but also the most resilient
553 when background signal does change in amplitude.

554 The selected configurations of the variables we have described above are the following:

555

- 556 - Source-detector distance of 1 cm ;
- 557 - Enrichment levels: natural enrichment, 1 wt%, 3 wt%, 8 wt%, 20 wt% ;
- 558 - Normal background signal, background \times 1.01, background \times 1.1 ;
- 559 - Measurement time $t \in \{100; 200; 300; 500; 1000; 3000\}$ s ;
- 560 - Hypothesis tests: KS, CNB, CBB.

561

562 This description leads to the generation of 270 ROC curves, from which we can determine tendencies with their
563 associated confidence intervals. We will only display the ROC curves for the modified background signal, with the
564 1 wt%, 3 wt%, 20 wt% enrichment levels and with simulated measurement times of $\{300; 3000\}$ s. The ROC of the
565 three hypothesis tests are superimposed on every curve.

566

567 Results
568
569
570

Figures 10 to 15 show the obtained results from the study aforementioned.

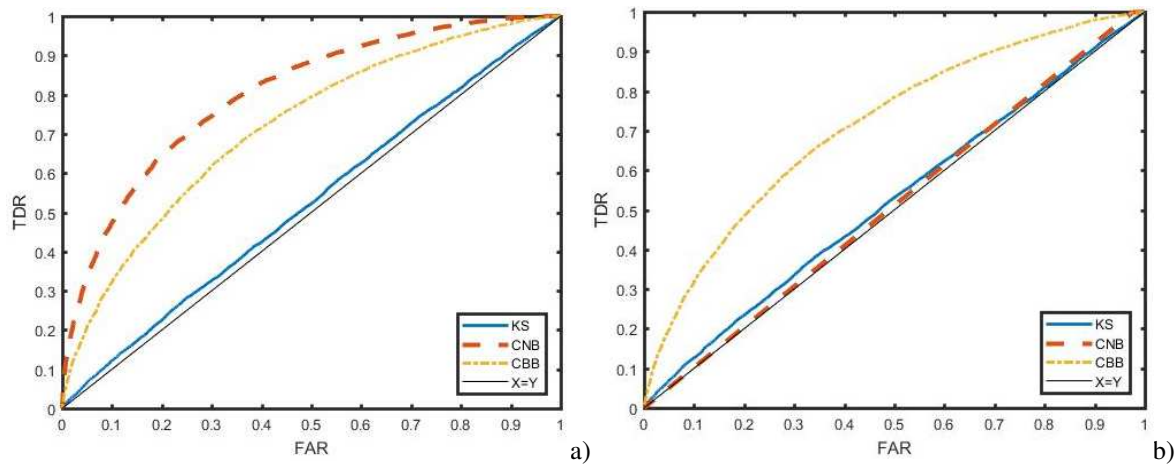

Fig. 10. ROC curve for an enrichment level of 1wt%, $t = 300$ s, with a background multiplied by a) 1.01, b) 1.1

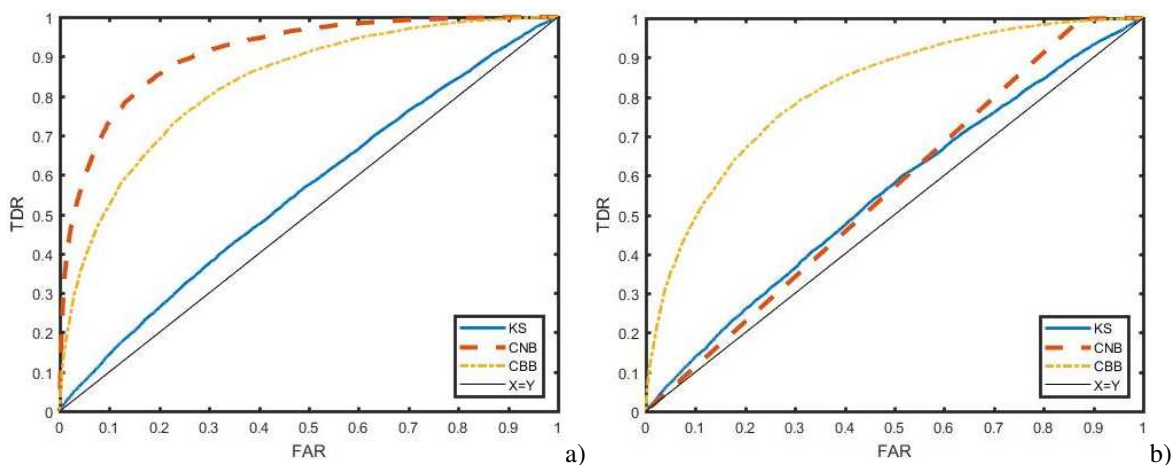

Fig. 11. ROC curve for an enrichment level of 3wt%, $t = 300$ s, with a background multiplied by a) 1.01, b) 1.1

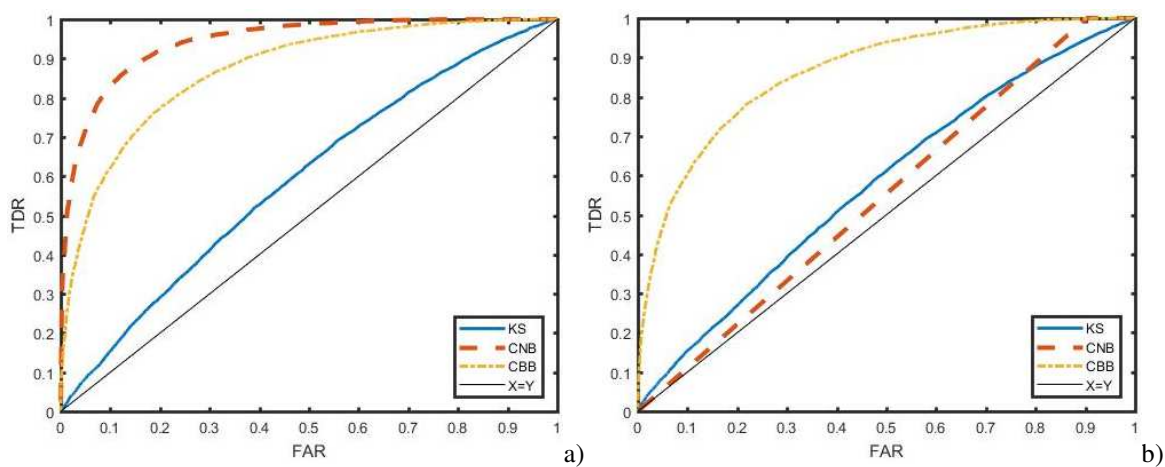
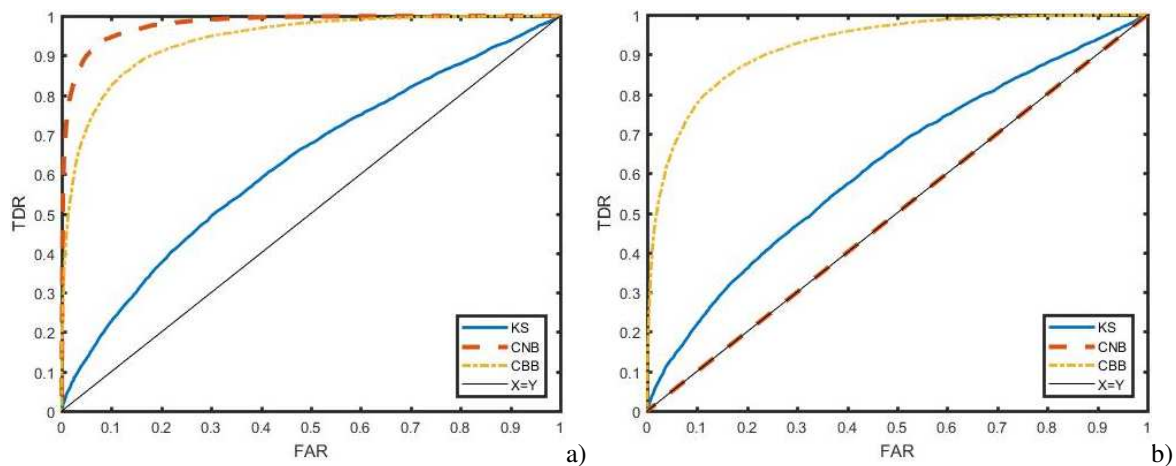

Fig. 12. ROC curve for an enrichment level of 20wt%, $t = 300$ s, with a background multiplied by a) 1.01, b) 1.1

585



586
587
588
589
590

Fig. 13. ROC curve for an enrichment level of 1wt%, $t = 3000$ s, with a background multiplied by a) 1.01, b) 1.1

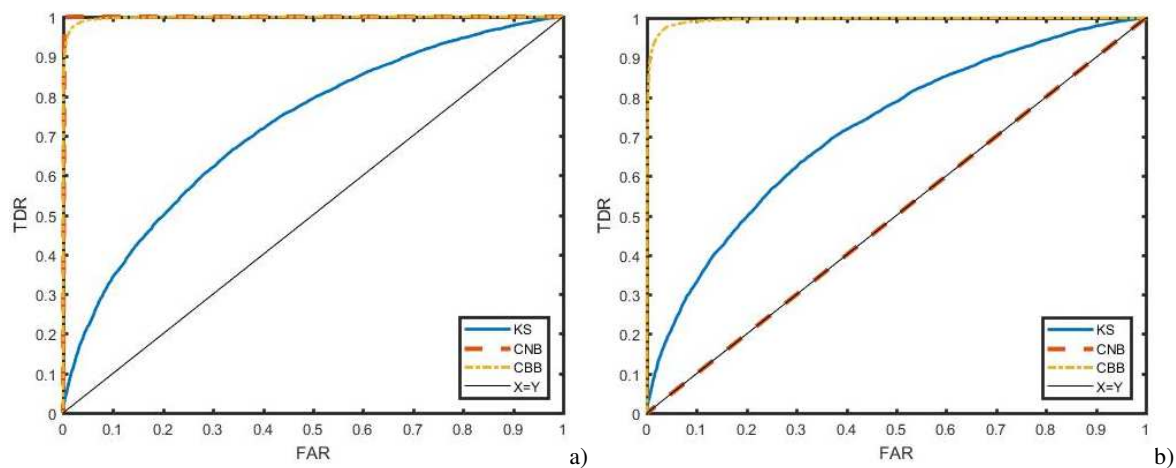

591
592
593
594
595
596

Fig. 14. ROC curve for an enrichment level of 3wt%, $t = 3000$ s, with a background multiplied by a) 1.01, b) 1.1

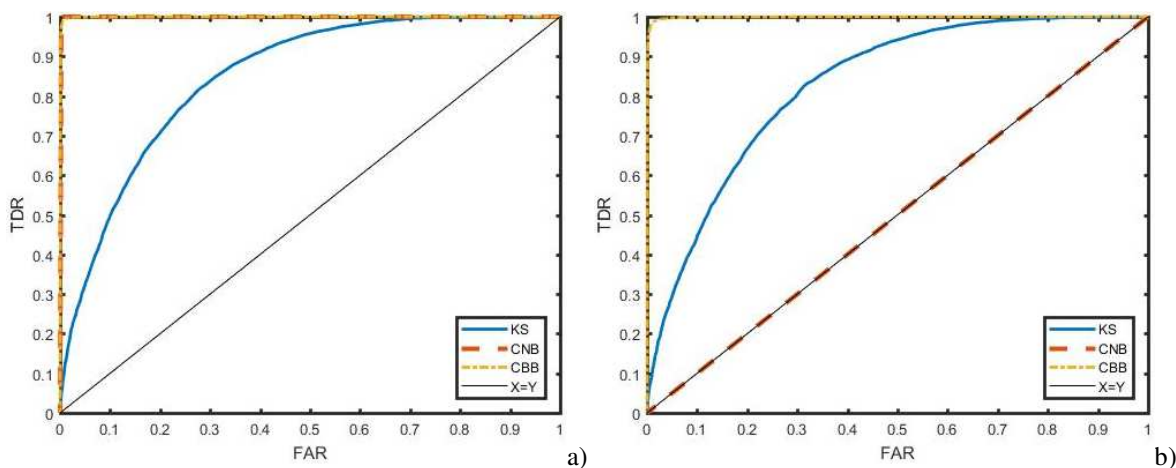

597
598
599
600
601
602

Fig. 15. ROC curve for an enrichment level of 20wt%, $t = 3000$ s, with a background multiplied by a) 1.01, b) 1.1

B. Interpretation of the results

603 The ROC curves presented above enable to describe explicit trends, which are in adequacy of the description of the
 604 hypothesis tests in V. B. According to figures 10 to 15, and also on ROC curves not shown in this paper, we conclude
 605 the following:

- 606 1) The ROC curves, for each hypothesis test, are more right-angled to the (0;1) point when the enrichment
 607 level is high. For example, the comparison of Fig. 10 a) (1wt%) and Fig. 12 a) (20 wt%) show an increase
 608 of the TDR – FAR rate, with the CNB test for the closest point to (0;1), (0.23;0.73) and (0.15;0.87)
 609 respectively. We explain this phenomenon with the bigger discriminability of the 185.7 keV gamma ray
 610 from the ²³⁵U decay chain, for higher enrichment levels, shown in Fig. 6.
- 611 2) The ROC curves, for each hypothesis test, are more right-angled to the (0;1) point when the simulated
 612 measurement time is long. For example, the comparison of Fig. 10 a) ($t = 300$ s) and Fig. 13 a)
 613 ($t = 3000$ s) show an increasing of the TDR – FAR rate, with the CBB test for the closest point to (0;1),
 614 (0.28;0.65) and (0.07;0.83) respectively. The variance reduction associated to a longer time of
 615 measurement explains this result.
- 616 3) For a stationary background signal, the CNB test yields better results, being the only absolute and
 617 unilateral test. In addition, when the background signal varies slightly (1%), we do not note any variation
 618 in performances over the different tests. But when the background varies more significantly (10%), the
 619 CNB test performances collapse, which is shown in figures 10 to 15 b). The ROC curve is overlapped
 620 with the diagonal (0;0) – (1;1). This is explained with the construction of the CNB test: Absolute test only
 621 remain operational under the hypothesis that the background signal is identical between the reference
 622 period and the test period. On the other hand, the KS and CBB test performances are not significantly
 623 affected by this variation (deviation of 5 %).

624
 625 As a partial conclusion, the KS test does not ever provide the highest performance in our study, being a bilateral
 626 test. Considering all parameters, the relative and unilateral test CBB gives the best compromise between sensibility to
 627 the signal and sensibility to the background variations. The ROC curves obtained are close to a perfect ROC curve
 628 (5 % close on the TDR – FAR rate) with high enrichment levels (Fig. 14 and 15 a)), considering a measurement time
 629 of 3000 s. Yet, when dealing with low enrichment levels, the CBB test performances drop as compared to the ones of
 630 the CNB test. Under the assumption that the reference background is truly representative of the measured spectrum,
 631 the CNB test can be preferred, else, when dealing with any background signal variation, we suggest using the CBB
 632 test.

633
 634 *C. Evolution of the True Detection Rate as a function of the acquisition time*
 635

636 In order to optimise the acquisition time and reduce the decommissioning costs, we studied the variation of the
 637 TDR as a function of time with a fixed FAR of 0.5. This represents a risk of 50 % of considering a non-contaminated
 638 surface of one square meter as radioactive waste. Using the results obtained for the ROC curves, we constructed
 639 different graphs of TDR as a function of time. For visualisation purposes, we will only display some of the results.

640 Figures 16 and 17 show the results of the study (TDR as a function of the measurement time) for an enrichment
 641 level of 1 wt%, with different background signals (reference, and multiplied by 1.1). Figure 18 show the same graph
 642 but with an enrichment level of 20 wt% and a background multiplied by 1.1.

643

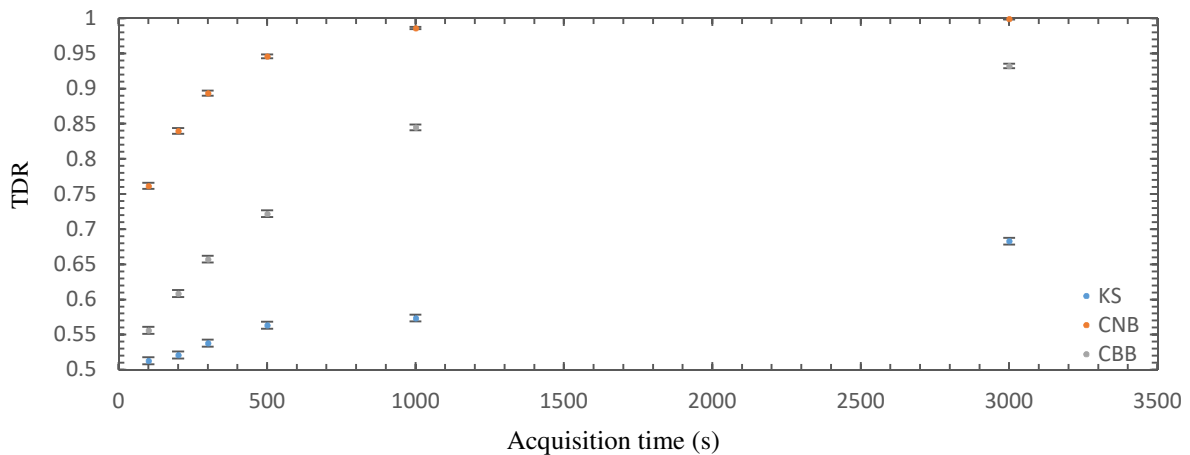

644
 645
 646

Fig. 16. TDR as a function of the acquisition time, for a FAR of 0.5, enrichment level of 1 wt%, and a reference background

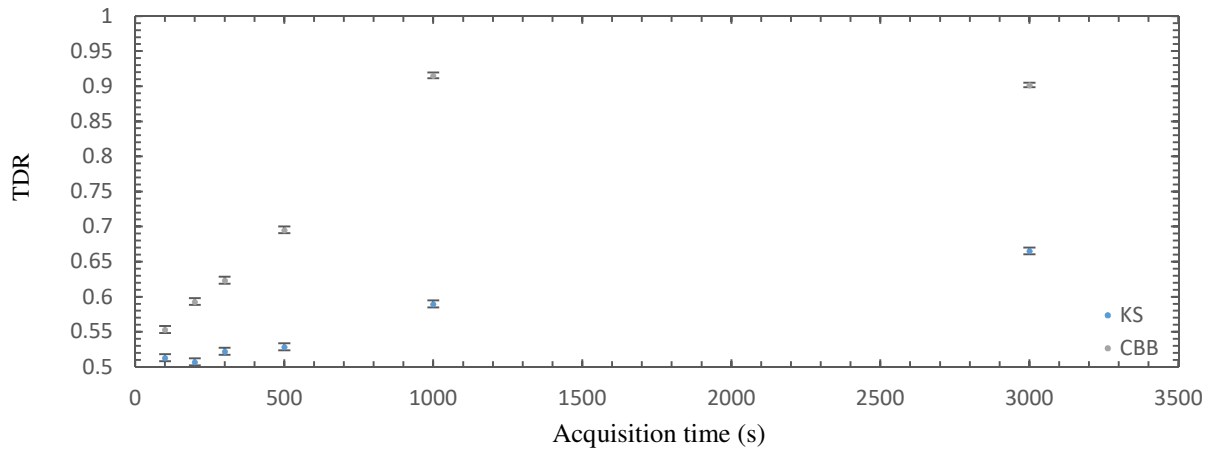

647
648 Fig. 17. TDR as a function of the acquisition time, for a FAR of 0.5, enrichment level of 1 wt%, and a background multiplied
649 by 1.1
650

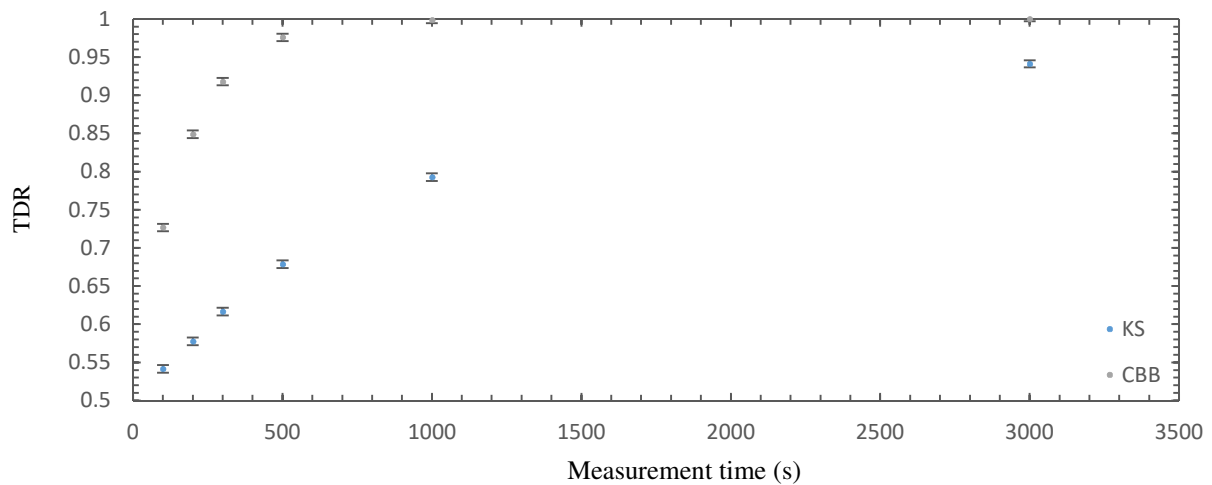

651
652 Fig. 18. TDR as a function of the acquisition time, for a FAR of 0.5, enrichment level of 20 wt%, and a background multiplied
653 by 1.1
654

655 We make the following observations, based on figures 16 to 18:

- 656
- 657 1) For an integration time $t = 500$ s and whether the background is multiplied by 1.1 or not, the CBB
658 test yields a TDR superior to 90 % for an enrichment level of 20 wt% ($TDR = 0.976$, Fig. 18).
 - 659 2) For an integration time $t = 500$ s and a stationary background, the CNB test yields a TDR superior to
660 90 % for an enrichment level of 1 wt% ($TDR = 0.945$, Fig. 16)
 - 661 3) From point 1 and 2, we can conclude that there is at least a hypothesis test able to achieve a
662 compromise TDR/FAR exceeding the factor of merit 50 % / 90 % with a measurement time of 500 s,
663 in the case of a stationary background
 - 664 4) Whether the background is multiplied by 1.1 or not, for a measurement time $t = 3000$ s, the CBB test
665 gives access to a TDR strictly superior to 90% for any enrichment level ($TDR = 0.932$, Fig. 16 ;
666 $TDR = 0.902$, Fig. 17 ; $TDR = 0.999$, Fig. 18)

667
668 Point 3 supports the deployability of this solution as a “first level” detector, used to assess the measured surface
669 before employing any other detectors, in a reasonable time. Considering a representative basic nuclear facility with a
670 total surface to assess of a hundred thousand square meters, a measurement time of 5 minutes per square meter results
671 in a total study time of 350 days.

672 Point 4 underlines the ability to deploy this solution as a “second level” high performance detector, used to confirm
673 the suspicion of a contamination, detected with another instrument which response time is lower (contamination
674 meters for example). Such a confirmation can be expected with a compromise TDR/FAR of 50 % / 100 % and a
675 measurement time under one hour per square meter.

676

677 VIII. General conclusion and outlooks
678

679 We recall here that the objective of this paper was to study the feasibility of a gamma spectrometry method to
680 decommission nuclear basic facilities, regarding low uranium contamination. The first result of this concept study is
681 the establishment of a complete methodology, dedicated to the dimensioning and the characterization of a
682 technological solution to the considered problem. This methodology is based on the construction of:

- 683 - A varying gamma-ray source term as a function of the uranium surface activity and the enrichment level of
684 ^{235}U
- 685 - A model of an HPGe detector with MCNP6.1 and calibrated using standard sources
- 686 - ROC curves allowing connecting, under the hypothesis of a minimal surface activity to detect and an
687 acceptable false alarm rate, a true detection rate and a radiological characterization time

688
689 As we said in the introduction, alpha signal, beta signal and gamma signal coming from uranium form three
690 measurands that can be used alternatively or, as a way to consolidate the alarm, cumulatively. In the latter, the
691 question is to know which measurand is exploited by a “first level” detector, which reliable response time must be the
692 fastest possible, and which measurand has to be used with a “second level” detector, as a confirmation for an alarm.

693
694 For a minimal surface activity to detect of $A = 2000 \text{ Bq } (\alpha) / \text{m}^2$, $\Omega = 2\pi \text{ sr}$, the algorithms tools developed enable
695 us to envision a TDR/FAR compromise exceeding the factor of merit 50 % / 90 % with a measurement time of 500 s /
696 m^2 , under the hypothesis that the background signal is stationary (else, exceeding a factor 50 % / 70 %). This
697 observation support the deployability of the proposed solution as a “first level” detector, used to scan the assessed
698 surface before any other instrument. This technological option is important in the case of the impossibility to use alpha
699 and beta measurands. Finally, the usage of plural HPGe detection heads would enable to refine the localization of the
700 contamination as well as reducing the measurement time per square meter.

701
702 In the case of high detection limits (which is true for low enrichment levels), of the dispersion of the distribution
703 (both in shapes and amplitudes), and of the difficulties behind the handling of HPGe detectors (cooling, fragility,
704 clutter), the most credible scenario is the usage of the presented method as a “second level” detector. Such a usage
705 withdraw the time constraint but impose a drastic minimization of the beta risk (wrong non-detection or false alarm).
706 Yet, we found that raising the measurement time to 3000 s / m^2 and considering a stationary background signal (which
707 is a reasonable hypothesis, since a background signal measurement will be conducted *ad hoc*), the CNB test factor of
708 merit exceeds 50 % / 99 % for any enrichment level. Table VII and VIII sum up the results mentioned in this
709 conclusion. We calculated a radiological characterization time, which corresponds to the measurement time times the
710 example BNF surface.

711
712 Table VII. *Characteristics and estimations of the factors of merit of the proposed solution for a “first level” detector,*
713 *stationary background*

Basic nuclear facility surface	Enrichment level (^{235}U)	Measurement time	FAR	TDR	Radiological characterization time
100000 m^2	1 wt%	500 s / m^2	50 %	94.6 %	578 d (3.6 y)
100000 m^2	3 wt%	500 s / m^2	50 %	97.9 %	578 d (3.6 y)
100000 m^2	8 wt%	500 s / m^2	50 %	99.6 %	578 d (3.6 y)
100000 m^2	20 wt%	500 s / m^2	50 %	99.9 %	578 d (3.6 y)

714
715 Table VIII. *Characteristics and estimations of the factors of merit of the proposed solution for a “second level” detector,*
716 *stationary background*

Basic nuclear facility surface	Enrichment level (^{235}U)	Measurement time	FAR	TDR
100000 m^2	1 wt%	3000 s / m^2	50 %	99.9 %
100000 m^2	3 wt%	3000 s / m^2	50 %	99.9 %
100000 m^2	8 wt%	3000 s / m^2	50 %	>99.9 %
100000 m^2	20 wt%	3000 s / m^2	50 %	>99.9 %

717
718 Obtained results in the framework of this study lead us to consider the following outlooks:

- 719 1) We have generated ROC curves and true detection rate as a function of the measurement time curves,
720 based on the minimal surface activities to detect, using MCNP6.1. We also used data from

721 experimental measurements on contaminated and non-contaminated surfaces. Since we do not know
722 precisely the enrichment level, it is impossible to link the results to the minimal surface activity to
723 detect. We propose the development of concrete sample where a precise contamination of uranium is
724 layered, enabling us to calibrate the ROC and the TDR/time of measurement curves. We will also
725 study the matrix effect, consequence of the state of the concrete surfaces.

- 726 2) As we stated in II. A. and C., we have a physical model of the gamma source term, associated to a
727 uranium surface contamination. This model will be used as an *a priori* in the construction of the H₁
728 hypothesis. For such an approach, we have developed Bayesian statistical tests, competing with CNB
729 and CBB, with promising performances [36]. Future work will be devoted to the study of the usage of
730 the Bayesian tests in this context: we propose to duplicate the characterization studies presented in VI
731 using the Bayesian tests.
- 732 3) Using innovative HPGe detectors, such as ones with an anti-Compton shield, can be studied to reduce
733 the impact of the background signal [16, 37]

734

735 Acknowledgements

736
737 The authors would like to thank the teams of P. Bourrelier from ORANO CYCLE, and of G. Aubert and J. Baticle
738 from ORANO DS, for their help in writing this paper.

740 References

- 741 [1] E. Neri, *et al.*, *Costs of Decommissioning Nuclear Power Plants (NEA--7201)*, Nuclear Energy Agency of
742 the OECD (NEA), 2016.
 - 743 [2] S. Aggarwal, *Alpha-particle spectrometry for the determination of alpha emitting isotopes in nuclear,*
744 *environmental and biological samples: Past, Present and Future*, Anal. Methods. 8. 10.1039/C6AY00920D, 2016.
 - 745 [3] P. Fichet, A. Leskinen, S. Guegan, F. Goutelard, *Characterization of Beta Emitters for Decommissioning,*
746 ASME, International Conference on Radioactive Waste Management and Environmental Remediation, Volume 2:
747 Facility Decontamination and Decommissioning; Environmental Remediation; Environmental Management/Public
748 Involvement/Crosscutting Issues/Global Partnering, Brussels, Belgium, September 8–12, 2013.
 - 749 [4] J. C. J. Dean, *et al.*, *Traceability for measurements of radioactivity in waste materials arising from nuclear*
750 *site decommissioning*, Metrologia 44 S140–S145, 2007.
 - 751 [5] G. R. Gilmore, *Practical Gamma-ray Spectrometry*, 2nd Edition, John Wiley & Sons Ltd, The Atrium,
752 Southern Gate, Chichester, West Sussex, England, pp. 41-47, 2008.
 - 753 [6] B. Pérot *et al.*, *The characterization of radioactive waste: a critical review of techniques implemented or*
754 *under development at CEA, France*, EPJ Nuclear Sci. Technol. 4 3, 2018.
 - 755 [7] AC02459866, ed. *Radiological characterization of shut down nuclear reactors for decommissioning*
756 *purposes*, International Atomic Energy Agency, 1998.
 - 757 [8] T. Z. Nonova, *et al.*, *Radiological characterization activities during the partial dismantling of the IRT-*
758 *SOFIA research reactor facilities*, Romanian Journal of Physics, 59(9-10), pp. 976-998, 2014.
 - 759 [9] A. Savidou, *et al.*, *Non-destructive technique to verify clearance of pipes*, Nuclear Tech. and Rad. Prot.,
760 Vol. 25 N°2, pp. 133-137, 2010.
 - 761 [10] R. Venkataraman, *et al.*, *Validation of in situ object counting system (ISOCS) mathematical efficiency*
762 *calibration software*, Nuclear Instruments and Methods in Physics Research Section A: Accelerators, Spectrometers,
763 Detectors and Associated Equipment, Vol. 422, pp. 450-454, 1999.
 - 764 [11] A. Alvarez, *et al.*, *Uranium determination in samples from decommissioning of nuclear facilities related to*
765 *the first stage of the nuclear fuel cycle*, Applied Radiation and Isotopes, Vol. 53 1-2, pp. 355-359, 2000.
- 776
777

- 778 [12] J. Bosen, *Improving accuracy of in-situ gamma-ray spectrometry*, doctoral dissertation, Radiofysik, 2008.
779
- 780 [13] A. Stepanov, *et al.*, *Development and Application of Collimated Spectrometric Systems for the*
781 *Characterization of Radioactive Contamination of Decommissioned Facilities – 15030*, Proceeding of the 15th Waste
782 Management Conference, Phoenix, Arizona, USA, 2015.
783
- 784 [14] V. E. Stepanov, *et al.*, *Remote-controlled collimated gamma-ray detector for measuring radioactive*
785 *contamination*, Atomic Energy, Vol. 109, N°2, pp.82-84, 2010.
786
- 787 [15] S. Garti, Q. Lecomte, J. Dumazert, K. Bourdergui, C. Jammes, *A high sensitivity Compton Suppressor*
788 *System for nuclear waste characterization*, ISOE European Symposium, Uppsala, 26-28 June 2018
789
- 790 [16] S. Garti, J. Dumazert, R. Coulon, Q. Lecomte, F. Carrel, G. Corre, M. Imbault, *et al.*, *Characterizing low-*
791 *activity waste containers: a case study for Compton Suppression Systems under challenging signal-to-noise ratio*,
792 Nuclear Inst. and Methods in Physics Research, A, *in press*, 2019.
793
- 794 [17] M.-M. Bé, V. Chisté, *Table de radionucléides*, LNE-LNHB/CEA, 2007.
795
- 796 [18] Y. Y. Ebaid, *Use of gamma-ray spectrometry for uranium isotopic analysis in environmental samples*,
797 Romanian Journal of Physics, Vol. 55, N° 1-2, pp. 69-74, 2010.
798
- 799 [19] M. Hult, E. Andreotti, R. González de Orduña, S. Pommé, Y. Yeltepe, *Quantification of uranium-238 in*
800 *environmental samples using gamma-ray spectrometry*, EPJ Web of Conferences, Vol. 24, 07005, 2012.
801
- 802 [20] M. Tsutsumi, T. Oishi, N. Kinouchi, R. Sakamoto, M. Yoshida, *Simulation of the background for gamma*
803 *detection system in the indoor environment of concrete buildings*, Journal of Nuclear Science and Technology, Vol. 38,
804 N° 12, pp. 1109-1114, 2001.
805
- 806 [21] T. Marchais, B. Pérot, C. Carasco, P.-G. Allineï, P. Chaussonnet, J.-L. Ma, H. Toubon, *Gamma-ray*
807 *spectroscopy measurements and simulations for uranium mining*, EPJ Web of Conferences, Vol. 170, 05003, 2018.
808
- 809 [22] A. Sari, F. Carrel, F. Lainé, *Characterization and Optimization of the Photoneutron Flux Emitted by a 6-*
810 *or 9-MeV Electron Accelerator for Neutron Interrogation Measurements*, IEEE Transactions on Nuclear Science, vol.
811 65, no. 9, pp. 2539-2546, 2018.
812
- 813 [23] D. B. Pelowitz (Ed.), *MCNP6TM User's Manual Version 1.0*, Los Alamos National Laboratory report, LA-
814 CP-13-00364, Rev. 0, 2013.
815
- 816 [24] A. L. Schwarz, R. A. Schwarz, and A. R. Schwarz, *MCNPX/6© Visual Editor Computer Code Manual*,
817 2018.
818
- 819 [25] *Evaluation of measurement data. Guide to the Expression of Uncertainty in Measurement*. Joint
820 Committee for Guides in Metrology–JCGM 100, ISO/IEC Guide 98–3, [http://www.iso.org/sites/JCGM/GUM-](http://www.iso.org/sites/JCGM/GUM-introduction.htm)
821 [introduction.htm](http://www.iso.org/sites/JCGM/GUM-introduction.htm), 2008 (last visited 21/05/2019).
822
- 823 [26] K. R. Murphy, B. Myers, A. Wolach, *Statistical Power Analysis, A Simple and General Model for*
824 *Traditional and Modern Hypothesis Tests, Fourth Edition*, 2014.
825
- 826 [27] A. A. Jarrett, *Statistical methods used in the measurement of radioactivity with some useful graphs and*
827 *nomographs*, No. AECU-262, 1946.
828
- 829 [28] T. H. Wonnacott, R. J. Wonnacott, *Introductory statistics*, 5th Edition, chapter 19, 1990.
830
- 831 [29] D. K. Fagan, S. M. Robinson, R. C. Runkle, *Statistical methods applied to gamma-ray spectroscopy*
832 *algorithms in nuclear security mission*, Applied Radiation and Isotopes, Vol. 70, Iss. 11, pp. 2428-2439, 2012.
833

- 834 [30] F. J. Massey, *The Kolmogorov-Smirnov Test for Goodness of Fit*, Journal of the American Statistical
835 Association, 46:253, 68-78, DOI: 10.1080/01621459.1951.10500769, 1951.
836
- 837 [31] P. R. Rider, *The Negative Binomial Distribution and the Incomplete Beta Function*, The American
838 Mathematical Monthly, vol. 69, no. 4, pp. 302–304, 1962.
839
- 840 [32] R. R. Wilcox, *A Review of the Beta-Binomial Model and its Extensions*, Journal of Educational Statistics,
841 6(1), 3–32, 1981
842
- 843 [33] J. Harold, *An invariant form for the prior probability in estimation problems*, Proceedings of the Royal
844 Society A, 186, 1946
845
- 846 [34] C. E. Metz, *Basic principles of ROC analysis*, Seminars in Nuclear Medicine, Volume 8, Issue 4, Pages
847 283-298, ISSN 0001-2998, 1978.
848
- 849 [35] MATLAB 2017a, The MathWorks, Natick, 2017
850
- 851 [36] E. Barat, T. Dautremer, N. Dufour, J. Dumazert, *Procédé de détection des faibles activités radiologiques et*
852 *produit-programme d'ordinateur associé*, French Atomic Energy Commission, Patent pending, 2019.
853
- 854 [37] R. Coulon, J. Dumazert, S. Garti, Q. Lecomte, *Système de spectrométrie, procédé de spectrométrie et*
855 *produit programme d'ordinateur associés*, French Atomic Energy Commission, Patent deposited on 27/09/2018 under
856 n° FR1858897, 2018.
857