



**HAL**  
open science

## A critical review on unmanned aerial vehicles power supply and energy management: Solutions, strategies, and prospects

Mohamed Nadir Boukoberine, Zhibin Zhou, Mohamed Benbouzid

### ► To cite this version:

Mohamed Nadir Boukoberine, Zhibin Zhou, Mohamed Benbouzid. A critical review on unmanned aerial vehicles power supply and energy management: Solutions, strategies, and prospects. *Applied Energy*, 2019, 255, pp.113823 -. 10.1016/j.apenergy.2019.113823 . hal-03487757

**HAL Id: hal-03487757**

**<https://hal.science/hal-03487757>**

Submitted on 20 Jul 2022

**HAL** is a multi-disciplinary open access archive for the deposit and dissemination of scientific research documents, whether they are published or not. The documents may come from teaching and research institutions in France or abroad, or from public or private research centers.

L'archive ouverte pluridisciplinaire **HAL**, est destinée au dépôt et à la diffusion de documents scientifiques de niveau recherche, publiés ou non, émanant des établissements d'enseignement et de recherche français ou étrangers, des laboratoires publics ou privés.



Distributed under a Creative Commons Attribution - NonCommercial 4.0 International License

# A Critical Review on Unmanned Aerial Vehicles Power Supply and Energy Management: Solutions, Strategies, and Prospects

Mohamed Nadir Boukoberine<sup>a</sup>, Zhibin Zhou<sup>b</sup>, Mohamed Benbouzid<sup>a,c,\*</sup>

<sup>a</sup>*University of Brest, UMR CNRS 60 IRDL, 29238 Brest, France*

<sup>b</sup>*ISEN Yncréa Ouest, UMR CNRS 6027 IRDL, 29200 Brest, France*

<sup>c</sup>*Shanghai Maritime University, 201306 Shanghai, China*

---

## Abstract

The interest in electric unmanned aerial vehicles (UAVs) is rapidly growing in recent years. The reason is that UAVs have abilities to perform some difficult or dangerous tasks, with high mobility, safety, and low cost. It should be noted that UAVs are revolutionizing many public services including real time monitoring, search and rescue, wildlife surveys, delivery services, wireless coverage, and precision agriculture. To increase endurance and achieve good performance, UAVs generally use a hybrid power supply system architecture. A hybrid power architecture may combine several power sources such as fuel cell, battery, solar cells, and supercapacitor. The choice of a suitable power source hybridization architecture with an optimal energy management system are therefore crucial to enable an efficient operation of advanced UAVs. In the context of battery-powered UAV platforms, including new technologies such as swapping laser-beam inflight recharging and tethering, this paper proposes a comprehensive and critical state of the art review on power supply configurations and energy management systems to find out gaps and to provide insights and recommendations for future research.

**Keywords:** UAV, power supply, energy management, swapping, laser-beam inflight recharging, tethered UAV.

---

## 1. Introduction

An unmanned aerial vehicle (UAV) is a flying robot, which can operate autonomously or controlled telemetrically to carry out a special mission [1]. UAVs have received great interest in the past few years thanks to advancements in microprocessors and artificial intelligence (AI) [2]

---

\*Corresponding author

*Email addresses:* [m.nadir.boukoberine@gmail.com](mailto:m.nadir.boukoberine@gmail.com) (Mohamed Nadir Boukoberine), [zhibin.zhou@isen-ouest.yncrea.fr](mailto:zhibin.zhou@isen-ouest.yncrea.fr) (Zhibin Zhou), [Mohamed.Benbouzid@univ-brest.fr](mailto:Mohamed.Benbouzid@univ-brest.fr) (Mohamed Benbouzid)

enabling smart UAVs [3], and motivated by several advantages such as low cost and high mobility. They are employed in several applications in both military and civil domains: minesweeping, monitoring, delivery, wireless coverage, and agriculture uses. Several multinationals are hugely investing in the improvement of UAVs performance to extend their uses as much as possible. It is expected that the UAV market value reaches US\$127 billions in 2020 [4]. Figure 1 shows the top 10 UAV operators ranking conducted in 2018 by Drone Industry Insights [5].

UAV features and configurations vary widely according to mission requirements. Thus, various types of classifications can be found in the literature focusing on different parameters [6, 7]. Regarding shape it was found fixed/rotary/flapping wing UAVs, hybrid and balloon configuration; regarding size, there are mini, micro, and nano UAVs. The North Atlantic Treaty Organization (NATO) categorized UAVs in three classes based on the maximum take-off weight (MTOW), where each class is divided into subcategories depending on altitude and mission radius [8]. Other classifications are discussed in [8].

Electric UAVs are favored for some of their key features such as reliability [9], reduced noise and thermal signatures [10], high efficiency [6], no pollutants emission, self-starting and developed control devices enabling high maneuverability. Internal combustion engine (ICE)-based UAVs have longer endurance due to ICE high power and energy densities [10]. However, they need an auxiliary starting motor, their control is more complex [11], and their acoustic and thermal signature are high. Some researchers [12, 13] combined the electric motor with the ICE in a hybrid architecture benefiting from the advantages of both engines. However, fossil fuels depletion and the increase in greenhouse gas (GHG) emissions decreased the interest in thermal engines and motivate the use of an electric propulsion as a green technology in different sectors such as transportation [14]. International policy and market-based momentum to phase out ICE vehicles have been investigated in [15], and this trend may be found in UAVs in the near future to facilitate more environmental-friendly devices. This can be one reason to abandon ICE in UAVs especially for tasks without long endurance requirement.

Electric power can be mainly provided by batteries, but their low energy density and long charging time prevent the UAV to have a sufficient flight-time [16]. In addition, battery may not allow an UAV to conduct some maneuvers needing fast power response due to its slow power dynamics. In this context, a supercapacitor is a good option to balance battery limitations [17]. It is worth to mention that flight endurance can be improved by aerodynamical optimization in

UAV design stage [18]. Current advancements in battery technologies allow slightly increasing the endurance for about 90 min using Lithium-Polymer (LiPo) batteries [19], while increasing the number of batteries is not a practical solution due to weight and space constraints. Extending UAVs endurance requires then the usage of additional power sources to balance batteries limitations while being compliant with weight and space restrictions. In this context, a fuel cell seems a good candidate due its high specific energy and quasi-instantaneous refueling. It can typically have up to five times higher energy density than LiPo batteries, which leads to a significant increase in the hybrid-UAV endurance [20]. It is worth noting that most available electrical UAVs are using a fuel cell as the main power source. A supercapacitor can also contribute to the power supplying process since it has very high power density and quick response to peak power needed in UAV takeoff and sudden maneuvers. Fixed-wing UAVs have the possibility to carry solar cells and use solar energy. Fuel consumption can be reduced [21], therefore extremely increasing the endurance, while using a storage system. Consequently, the power supply system hybridization, by combining two or more power sources, seems to be the best option to insure a large endurance for a UAV. The power supply system structure choice is however crucial. Indeed, it depends not only on the power sources characteristics, but also on the UAV mission requirements. In this context, an energy management system (EMS) is mandatory to optimally control the power splitting between the onboard power sources to achieve the targeted mission with high performance and high efficiency. An EMS typically includes current and voltage sensors to track the power flow, converters to control power sources outputs, and a processing unit handling the adopted power management strategy. Beside hybridization, other techniques can be used to extend battery-based UAVs endurance : swapping [22, 23, 24], laser-beam inflight recharging [25, 26, 23], and tethered UAVs [27, 28, 29]. Swapping is a technique used to recharge the UAV's depleted batteries during its mission. For this purpose, ground stations are deployed in specific locations. A flying UAV can receive light power by means of a laser-beam transmitted from a generator deployed in a ground station. The UAV batteries are therefore recharged without landing. Tethered UAVs can have unlimited endurance because the power will be continuously provided through connection lines linking the UAV to the power supply ground station.

In the literature, it has been found some review papers addressing different aspects of UAVs, such as fuel storage and generation in small fixed-wing UAVs [16]; classification, advances and research trends in small-scale UAVs [30]; UAV-related technologies and applications in civil engi-

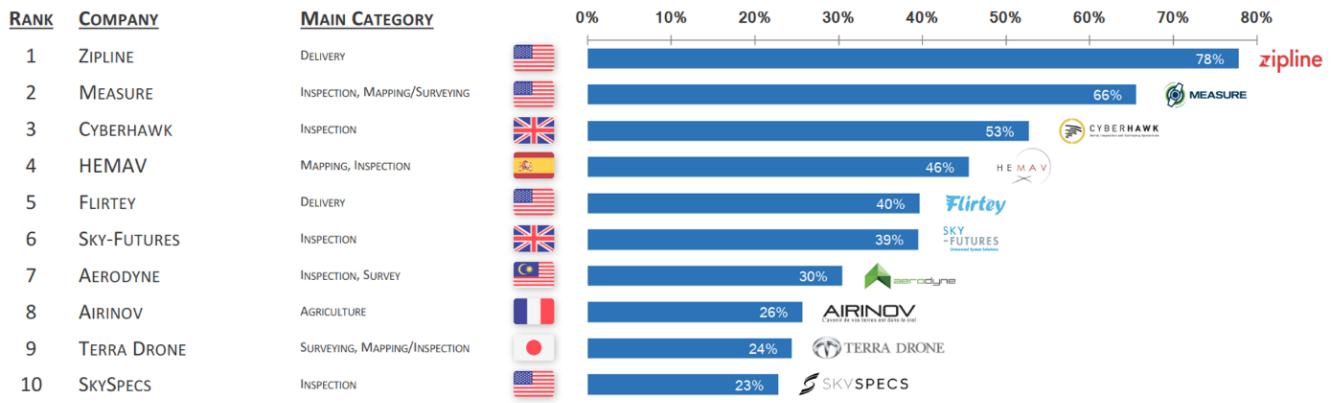

Feb. 2018, basis of assessment: The ranking is based on the following indicators with different emphasis stated in brackets: Size of company (1), number of followers (1), amount of funding (1), number of partnerships (0.5), and the extend of web activity (two different categories with an emphasis of 1.5). The highest scoring company in each dimension receives a rating of 100%, while all other drone companies receiving a lower percentage in linear relation to the score of the highest ranking company. The total score is an average of all four measured dimensions. A company can reach an index of 100% if he leads all considered sources.

Figure 1: Top 10 UAV operators ranking in 2018 [5].

neering [1]; UAV challenges across civil applications [7]. Moreover, they considered classification and design challenges of UAVs [6]; fixed-wing UAVs path planning algorithms [31]; guidance, navigation, and control of rotorcraft unmanned aircraft systems [32]; and quadrotors modeling and control [33]. Unlike these previous review papers, this one will focus on UAVs energy aspect with a comprehensive and critical evaluation of the available power supply structures [34] and their energy management systems. Afterwards, gaps will be identified, while providing useful guiding recommendations and prospects.

This review paper is organized as follows: Section 2 presents unmanned aerial systems (UAS) basic knowledge including UAS parts, UAVs classifications and applications. Section 3 discusses and analyses UAVs power sources and supplying architectures methods, while Section 4 provides a critical review on UAVs energy management strategies.

## 2. Unmanned Aerial System (UAS) Basic Knowledge

### 2.1. UAS Basic Parts

An unmanned aerial system (UAS), illustrated by Fig. 2, is basically composed by three parts:

- The unmanned aerial vehicle (UAV);
- The ground control station (GCS), which can be autonomous or human-operated;
- The command and control system ensuring communication and data links between the UAV and the ground station.

**Unmanned aerial vehicle (UAV).** As depicted in Fig. 2, the UAV platform includes (1) an onboard flight control system based on processing units handling essential tasks, such as guidance, navigation and control (GNC) algorithms, in-flight data gathering and analysis, communication with the ground station, and mission planning; (2) a propulsion system including power supply sources, speed controller, converters, energy management system, motor, and propeller; (3) the required sensors to maintain an autonomous flight; and (4) payload: equipment needed for the missions, such as actuators, cameras and radar [30].

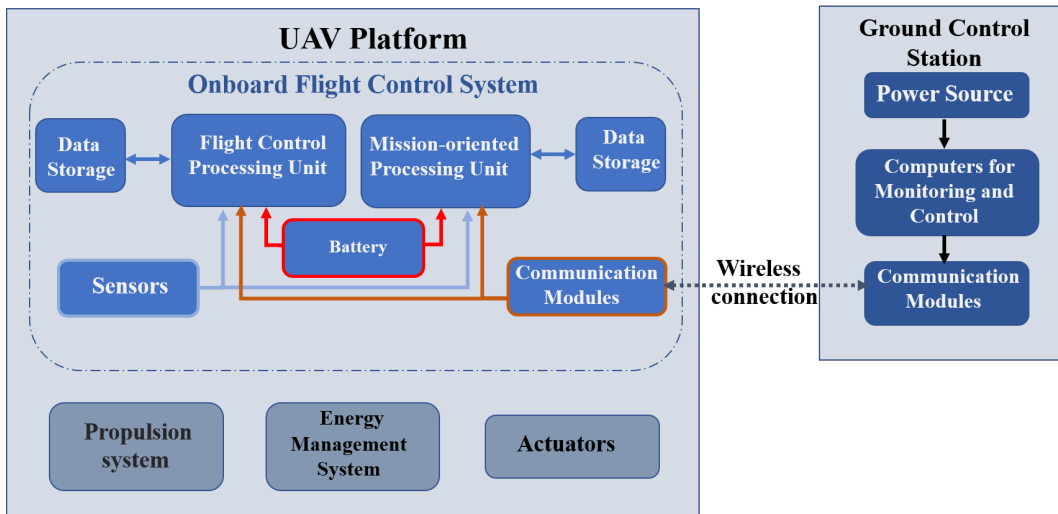

Figure 2: Block diagram of a typical UAS.

In the UAV, the propulsion system is the main onboard power consuming part. Indeed, it allows the UAV motion by converting the stored electrical energy into a mechanical power generated by the motor-propeller system. It can constitute more than half of the UAV weight. Figure 3 shows the schematic diagram of a typical UAV propulsion system.

The onboard sources deliver power to the DC bus through unidirectional and bidirectional converters to enable battery charging and discharging. These converters allow controlling the power flow. They receive control signals from the EMS that handles power splitting. Small UAVs widely used motor type is the brushless DC (BLDC) motor, thanks to its key features, such as high efficiency and power density [35], high speed and good torque characteristics, reliability, ease of control, and long lifetime [36]. Although induction motors are advantageous in terms of low cost and robustness, they have some limitations, such as a relatively low efficiency, cooling issue, and low torque.

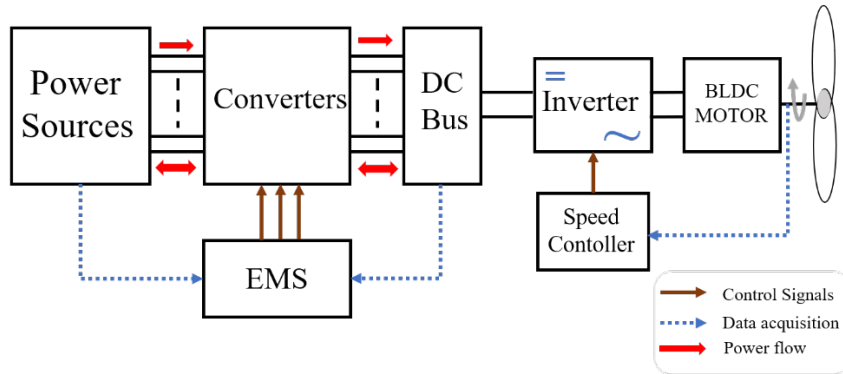

Figure 3: Block diagram of a UAV propulsion system.

## 2.2. UAVs Classifications

Several criteria can be considered to classify UAVs such as size, fuselage (rotary, fixed, flapping wings) [33], endurance, flight range, MTOW, flying mode (lighter than air, heavier than air) [37], and mission or application. Thus, we cannot find acknowledged unique classification in the literature. Authors in [38] proposed a comparative study between three UAV configurations, namely: fixed-wing, rotary wing, and hybrid. Classifications based just on weight parameter are proposed in [39]. In [40], mission is considered as the main criterion to classify UAVs as miniature, tactical, strategic, and loitering munition. Cai et al. [30] proposed a classification based on six characteristics of UAVs with a MTOW less than 25 kg. In this case, 132 UAVs available models were investigated leading to the proposal of three categories (Table 1): small tactical, miniature, and micro UAVs. This classification is summarized in Fig. 4.

Table 1: UAV classification proposed in [30].

Specs	Small tactical	Miniature	Micro
Size	<10 m	<5 m	<15 m
MTOW	10-25 kg	<10 kg	<100 g
Speed	<130 m/s	<50 m/s	<15 m/s
Altitude (m)	<3500 AGL*	<1200 AGL	<100 AGL
Range	<50 km	<25 km	<10 km
Endurance	Up to 48 h	Up to 48 h	Up to 20 min

\* AGL: Above Ground Level.

Hassanalain and Abdelkefi [6] introduced a new classification considering UAV configuration. Indeed, they have proposed spectrum to define drone classes based on weight and wingspan with maximums of 1500 kg and 61 m, respectively. The spectrum includes six categories: UAV, micro UAV, micro air vehicle, nano air vehicle, pico air vehicle, and smart dust. The UAV class



Figure 4: Illustration of the classification proposed in [30].

includes horizontal take-off and landing, vertical take-off and landing, hybrid configuration, helicopter, heli-wing, and unconventional models. This study have also considered a bio-UAV, which is an equipped insect or bird used for specific missions. Gupta et al. [41] classified UAVs based on their roles in military applications: high altitude long endurance (HALE), medium altitude long endurance (MALE), tactical UAV (TUAV), mini UAV, micro UAV, and nano Air Vehicles. Valavanis and Vachtsevano [8] discussed military classifications and other categorizations based on (1) MTOW and ground impact risk, (2) operational altitude and midair collision risk, (3) autonomy, (4) ownership. Figure 5 is an illustration of the UAVs configuration-based classification proposed in [42].

### 2.3. UAV Applications

UAVs have entered several both civil and military application areas, thanks to academic research and industrial projects advances. By integrating sensors and camera, UAVs can now perform difficult and risky missions without human intervention. This is done with high efficiency, rapidity, while maintaining low cost [38].

#### 2.3.1. Inspection and monitoring

##### 1) Traffic monitoring:

Nowadays, UAVs play an important role in traffic monitoring. They continuously collect data in real-time about roads and traffic conditions and transfer information to the monitoring center. UAVs present many advantages compared with traditional roads monitoring methods (radar sensors, fixed surveillance video cameras), such as flexibility, large coverage range instead of fixed one, rapidity, and accuracy to detect incidents. They can also be efficient in traffic estimation [43].



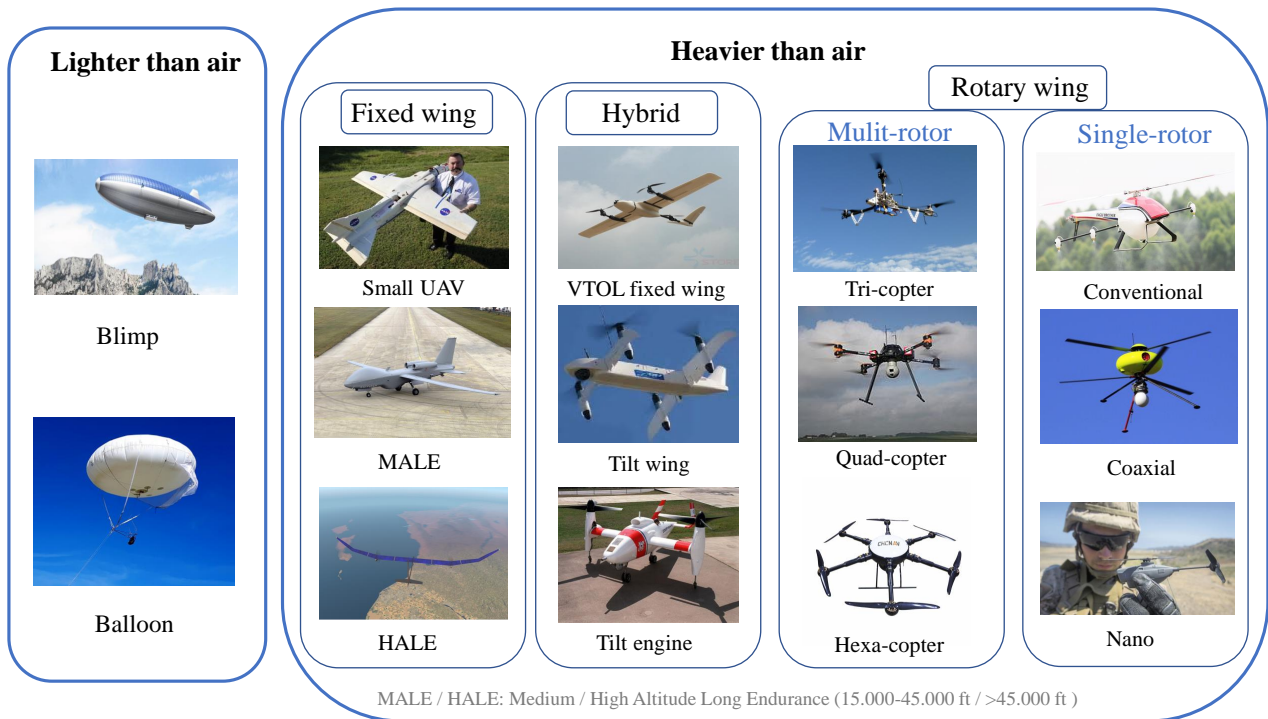

Figure 5: UAVs configuration-based classification [42].

Guido et al. [44] employ UAVs in their methodology of vehicle tracking. The authors emphasize the usefulness of using UAVs in traffic management by recording and processing collected data. Leitloff et al. [45] proposed UAV based systems as a solution for traffic monitoring in case of disaster or mass events. In this context, devices for online acquisition, assessment, and sharing traffic information, are installed onboard the UAV. The literature is typically rich with traffic monitoring and vehicle tracking applications and case studies [46].

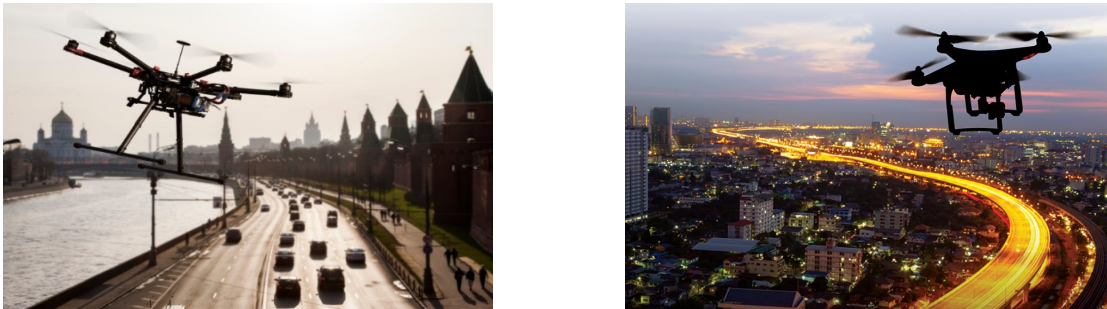

Figure 6: UAV-based traffic monitoring [47, 48].

## 2) Infrastructures inspection and monitoring:

Construction of large-scale infrastructures such as big buildings and highways require a huge number of employees and machines deployed in a large working area. UAVs can facilitate monitoring operations for managers to be up to date with the state of advancement of the project, and

to control tasks without the need to access the construction site.

AT&T (American Telephone & Telegraph) conducts an automated inspection of more than 65,000 cell towers based on video analytics using UAVs [49]. Efficient deep learning algorithms are implemented to conduct online detection of system faults or malfunctions. Smart grid power lines monitoring using industrial Internet of UAVs is investigated in [50]. In [51], authors discussed a method for inspection of power lines, substations, and transformers. In this context, the UAV is equipped by infrared (IR) cameras to detect bad conductivity in power lines by processing recorded images (Fig. 7 (b)). In parallel, the approach aimed to accurately identify buildings and vegetation that are in proximity to the power lines.

In a recent experimental study, Márquez and Segovia [52] equipped a UAV with a radiometric sensor and a thermographic camera in order to estimate dust accumulation on solar photovoltaic panels (Fig. 7 (a)). This application seems to be important since the loss in energy production caused by dust can reach up to 15 % in one year [52]. In [53], a wind turbine blade surface cracks detection framework is proposed using UAV-based aerial imaging and image processing.

In [54], authors were interested in the inspection of water, gas, and oil pipelines. UAVs conduct autonomously remote sensing, visual, and thermal inspections based on onboard sensors, which enable detection of gas leaks in dangerous or hard-to-reach sites. The literature is typically rich with infrastructures inspection and monitoring illustrations and case studies [55].



(a) UAV-based solar photovoltaic panels inspection [56, 57].



(b) UAV-based power lines inspection [58, 3].

Figure 7: UAV-based infrastructures inspection.

### 3) Environmental monitoring:

Governments, all around the world, are in continuous interest for information and updated data about environmental changes and their impacts. In context, periodic measures are conducted on top of volcanoes, mountains, rivers, seas, and even in the atmosphere [38]. UAVs are then used as an effective tool for collecting samples thanks to their dynamic characteristics. Civil protection institutions can accurately monitor water resources before, during, and after a flood occurs, thus, preparing a damage control plan. Furthermore, by deploying several UAVs above volcanoes, it would be possible to have online measurements to safely estimate a volcano state (Fig. 8 (a)). In 2013, the NASA conducted flights to take measurements on a volcanic plume near San José, at Costa Rica, using the RQ-14 Dragon Eye drones made by AeroVironment, which have an endurance of 80 min [59]. In case of disaster, communication and computing infrastructures may be damaged [45], so UAVs can quickly provide details and data to enable efficient control of rescue operations. Monitoring of pollution can be performed by UAVs equipped by specific sensors, enabling real-time measurement of polluting gases diffusivity, such as CO, CO<sub>2</sub>, SO<sub>2</sub>, and NO<sub>2</sub> (Fig. 8 (b)). In [60], fixed-wing UAVs were employed to capture high-resolution images, which help in studying water pollution. Others relevant illustrations and case studies on UAV-based environmental monitoring can be found in [61, 62].



(a) UAV-based volcano monitoring [63].



(b) UAV-based pollution monitoring [64].

Figure 8: UAV-based Environmental monitoring.

#### 2.3.2. Delivery

Several companies around the world are using UAVs for fast delivery of goods or packages [6] (9), such as DHL postal service in Germany [65], Google and Amazon in USA [66], and others. UAVs can serve also for delivery of medical supplies in emergency cases [7]. A typical illustration is the case of the Federal Aviation Administration (FAA) that conducted the first UAV-based medical delivery in 2015 [67]. The operation was based on GPS coordinates to reach the delivery

location, where the UAV was equipped with a checking device to confirm that the package reaches the right customer/receiver. Other illustrative examples of UAV-based delivery can be found in [68, 69].



Figure 9: UAV-based delivery [70, 71].

### 2.3.3. Agriculture

In recent years, UAVs become an attractive option in agriculture to gather low-altitude high-precision images above the field [72, 73]. Then, appropriate image processing operators or software are used to extract valuable data about the state of the cultures and health information such as moisture and soil properties. UAVs can also be used in several tasks such as irrigation scheduling, disease detection, soil texture mapping, weed detection, residue cover, tillage mapping, crops management, cultivations analysis and other applications in precision agriculture (Fig. 10) [74, 75].



Figure 10: UAVs used in precision agriculture [76, 77].

### 2.3.4. Wireless coverage

UAVs can be used for wireless information transfer as flying access points (Fig. 11)[4]. They can cooperate with the cellular network to provide a better coverage for isolated areas that are badly covered due to obstacles such as mountains or buildings. UAVs can be deployed as relay nodes to replace ground base stations of the communication network, in case of malfunction or damage due to disaster for example [7]. Other illustrative studies dealing with UAV-based wireless

coverage can be found in [78].

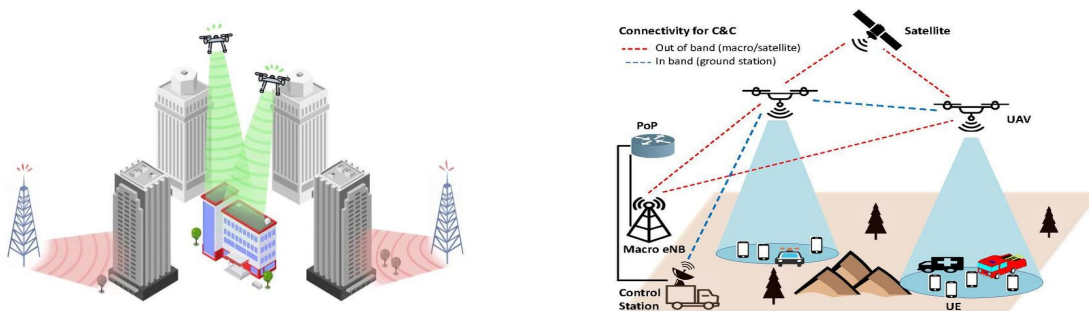

Figure 11: UAV-based wireless coverage illustrations [79, 80].

### 2.3.5. Military applications

Originally, UAVs were restricted to military applications. They were afterward extended to the civil sector. Well-known UAVs (generally called drones) military applications are: artillery guidance, delivery of equipment and supplies, radio and data relay, borders surveillance, spy drones, communication disruptors and electronic warfare, maritime operations (anti-ship missile defense, naval fire support, over the horizon targeting), reconnaissance flights, minesweeping raking, Etc. (Fig. 12) [8].

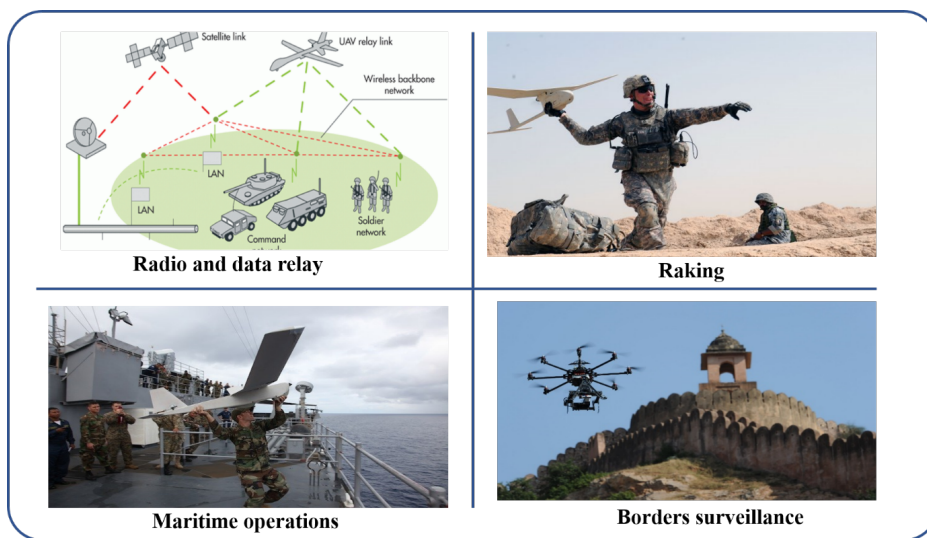

Figure 12: UAVs military applications [81, 82, 83, 84].

## 3. UAV Power Sources

Gas turbine engines have been used in aircraft propulsion systems for their high power-to-weight ratio [85] and long operating time [6]. However, they present good performances only for

high power ranges [86], above 100 hp [85]. They are however not suited for small-scale UAV applications as they exhibit low fuel economy and a very low efficiency with a high noise level [85].

The internal combustion engine (ICE) constituted the pillar of aircrafts propulsion system [87]. Comparatively to an electric motor (EM), an ICE, thanks to its higher fuel energy and power densities, allows long flight time and large payload range, which are two important challenges in airborne applications. However, the multi-step process of producing energy reduces the ICE system efficiency [88]. EMs are preferred for UAVs due to many key features such as their very low thermal and acoustic signatures, well developed electronic control systems, ease-adaptation to automatic control, self-starting feature [11], low cost, and a higher reliability minimizing crash possibility due to motor shutdown or failure. It is worth noting that in electric propulsion systems, electronic speed controller (ESC) failure may occur due to overheating and melting of ESC casing. Duplicating components can be a solution to this issue [89].

A hybrid power propulsion prototype for UASs was proposed in [11]. The purpose was to combine the benefits of both thermal and electric engines into a hybrid architecture. However, even the simulation results proved an endurance improvement of 13%, the system is complex and not environmentally friend. In the same context, other authors, such as Bonbergino et al. [10, 90], and Xie et al. [12], have also discussed a hybrid parallel powertrain architecture which using both EM and ICE. Incorporating an ICE in UAVs is unfortunately not yet a solution of choice in terms of fuel usage and endurance optimization limited degree of freedom. In this context, this section will be restricted to electric propulsion-based UAVs, therefore discussing and critically evaluating electric power sources supplying UAVs. Interesting supplying strategies will also be presented for one-source-based UAVs, such as swapping, laser-beam inflight recharging, and tethered UAVs.

### *3.1. Battery-based Supplying Techniques*

#### *3.1.1. Battery-powered UAVs*

Most small UAVs, especially quadrotors are battery-powered. Indeed, batteries are considered as the main component in battery-powered UAVs [91], their usage improves the simplicity and the flexibility of the propulsion system. Moreover, battery-based platforms can satisfy various hobbyist applications in term of flight time and cost-effectiveness. However, typical small battery-powered UAVs have short endurance due to constraints on the battery pack weight. They can fly for a maximum of 90 min using LiPo batteries [19]. Consequently, these small-scale UAVs are usually devoted for commercial ends. Lithium batteries are preferred for small UAVs due to their low

weight and relatively high specific energy. Indeed, LiPo batteries power almost 90% of micro aerial vehicles with a weight less than 2 kg and a length less than 100 cm [6]. Table 2 details the key characteristics of four types of battery technologies, namely specific energy, energy density, and specific power. This will allow the technology choice for an UAV with a given application and mission. In [92], different battery technologies are evaluated in term of state of charge (SOC) for a given mission.

Table 2: Comparison of different batteries [93].

<b>Characteristic</b>	<b>Ni-Cd</b>	<b>Ni-Mh</b>	<b>LiPo</b>	<b>Li-S</b>
Specific energy (Wh/kg)	40	80	180	350
Energy density (Wh/l)	100	300	300	350
Specific power (W/kg)	300	900	2800	600

In [94], Traub investigated parameters that affect performances of a battery-powered UAV and developed mathematical expressions to estimate the range and endurance considering the battery discharge conditions. This mathematical formulation was not evaluated by simulation nor experimentally tested. One of the biggest challenges with batteries powered electric vehicles is the reduced autonomy. Intensive research efforts were thus focused toward improvements of batteries performances to extend their operational time and enable electric vehicles to conduct long-duration missions. Nevertheless, even with advancements in batteries characteristics, the specific energy of current battery technology still limits endurance and range. Therefore, they will not reach many UAV applications needs. Additionally, both stability and safety levels are affected as a result of energy density improvement [95]. Thus, different solutions were developed in the literature to deal with battery limitations. Fuel cells seem to be a good alternative due to their performances especially the higher specific energy. Furthermore, most existing UAVs are powered by more than one energy source, where batteries, fuel cells, solar cells, and supercapacitors are hybridized to form the UAV power supply.

### 3.1.2. *Swapping*

Swapping is a technique used to recharge the UAV's depleted batteries during its mission. It can be conducted autonomously or human-operated. Hotswapping is a specific technique where a depleted battery is replaced by a fully charged one, keeping the UAV powered on. It can then join its hotspot and operates again. By deploying more than one UAV and by managing their cooperation so that a vehicle can hand over its hotspot seamlessly to another one, the multi-agent system

can provide continuous service to an area [23]. Three conditions must be fulfilled to complete a typical swapping operation: (1) ground recharge station where UAVs can land for charging/charging batteries, (2) UAV swarm for persistent applications, (3) the management system to ensure UAVs swarm cooperation. Figure 13 and 14 illustrate the swapping and Hotswapping techniques.

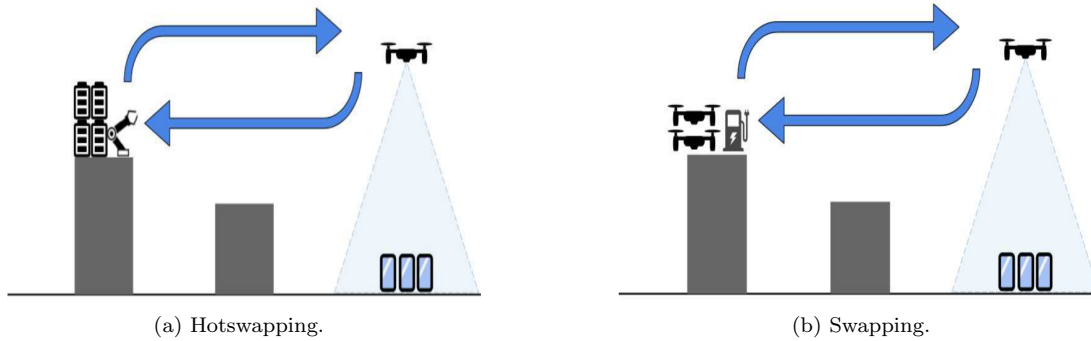

Figure 13: Swapping vs hotswapping techniques [23].

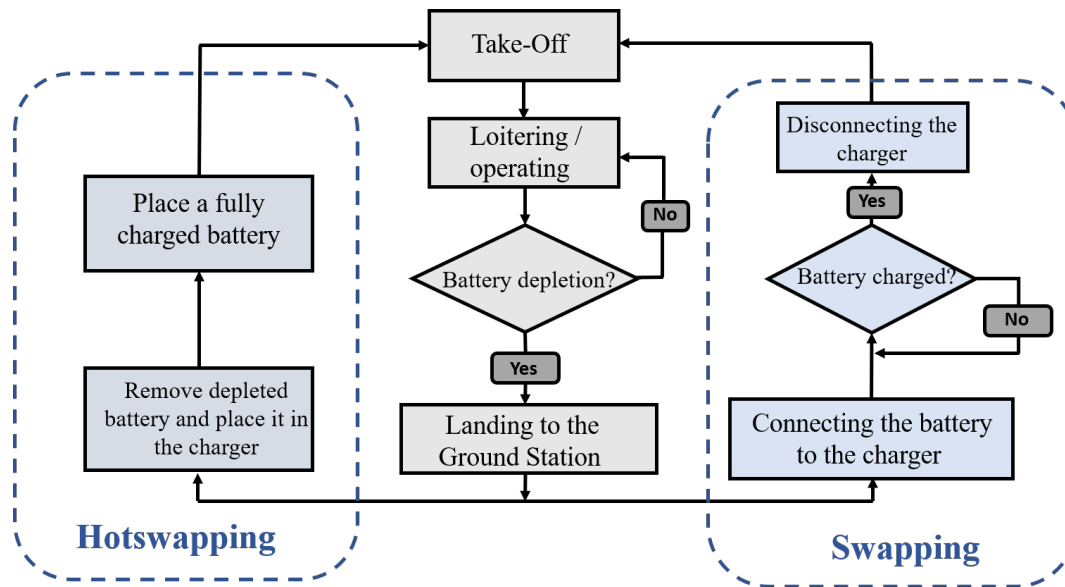

Figure 14: Swapping and Hotswapping Algorithms.

Ground stations (GSs) are deployed in specific locations such as cities or along trajectories connecting cities to establish an infrastructure network [96]. Their installation can be done on cell towers, street lights, rooftops, power poles, or standalone pylons [97, 98]. The battery swap station includes several components: ground electronics, onboard circuit, landing frame and a contact mechanism [99]. The battery can be charged by contact enabling paths or by inductive coupling [100], and the docking platforms can be fed by power lines, big batteries and solar cells for remote stations. Figure 15 shows some commercially available GSs.

In [24], Williams and Yakimenko developed a multi-rotor aerial prototype for long-duration





Figure 15: UAV's charging stations [96, 101].

missions using the swapping approach, where the objective was to maintain the airborne platform operation based on the battery SOC monitoring. The concept is to keep one of three quadcopters continuously on the loiter position, when the battery SOC drops under a defined threshold. The second quadcopter takes over and allows the former to join the ground station to put the battery on charging and get a replenished one to be ready to its next use. This system cycles through vehicles until all batteries are exhausted or the mission is accomplished. Batteries necessary number to ensure durable operation depends on the discharge time and the required charging time, and do not depend on the UAVs number. Nevertheless, the bigger it is, the more robust the system becomes. However, changing and charging batteries on the launch platform was not done automatically, so the system still restricted to human intervention. Additionally, regarding their field test, no special mission using sensors was conducted, only static loitering was performed.

An economical comparison between battery refilling/recharging platforms has been proposed in [102]. Three stations were developed based on an axiomatic design before being investigated, which enable the authors to present analysis linking the cost, complexity, and coverage levels. It was shown that refilling stations are a good choice when the coverage is low, otherwise, it is preferable to use exchange stations.

Suzuki et al. [103] presented a comparison between battery charging/replacement systems using a Petri net model. The authors also presented a detailed and illustrated discussion about the design options of autonomous swapping stations. The target was to conduct a precise UAV positioning for swapping regardless of landing error. However, the estimated swap time was nearly one minute, which is a considerable time comparatively to other works [104, 105]. In addition, the system was not fully operational. Indeed, some modules were not prototyped nor tested.

In another study [99], a ground recharge station for battery powered quadrotor helicopters was designed and an algorithm was implemented to reduce the battery recharge duration. The

proposed autonomous charging process uses safer electrical contacts and a balancer. It was intended for swarm applications. In this case, as in the majority of the carried studies, there were no experiments nor flight tests. It should be mentioned that the battery lifetime was neglected.

A design and hardware implementation of an automated refueling station for small-scaled UAVs is presented in [106]. In order to extend the operational time and enable long-duration autonomous missions with multi-agent UAV systems, a planning and learning algorithm was developed and tested in 3 h long persistent flight using three UAVs and more than 100 battery swaps. The battery recharger mechanism to exchange batteries is based on a linear sweeping motion leading to a simple and robust design. However, the system cost was not considered, while increasing the number of batteries and UAVs can lead to a costly and complex to manage system.

In [107] Swieringa et al. proposed a swapping system based on online algorithms to perform energy management, UAV health monitoring, and accurate landing. In this approach, a servo-based lift is employed to swap and place the batteries onto a hexagonal mat horizontally mounted, which holds the charging batteries. However, that swap mechanism induces UAVs power losses. Even individual tests were done for all the components, the entire system was not tested.

In [104, 105], active infrared imaging were used to design an autonomous docking platform. The system, operating in day and night time includes a camera and an infrared filter for high precision landing. The UAV landing operation is guided based on image processing and the swapping process is reduced to less than 10 seconds instead of 60 in [108]. In this study, the focus was just on the swapping time and landing precision. Cooperation between UAVs was not discussed and the improvement of the operational time was not proved by any definite long-duration mission.

A hardware platform was proposed in [109] including a dual-drum structure to perform fast and efficient hotswapping using a buffer of 8 batteries. The experimental work includes results about the needed battery swapping average time. In this study, a flight test was conducted considering a search and track mission with communication constraints. However, the developed station with 3 quadrotors performs that mission for about 70 min as a maximum operational time.

In a recent paper [22], Bocewicz et al. were interested in cyclically repeated missions such as aerial delivery services. In this approach, mobile battery swapping stations (MBSs) are proposed, they move to given swapping points at defined times according to a preset timetable. Thus, UAVs can join the suitable station for battery replacement and also for loading/unloading of goods. In this study, where the MBSs routing problem was considered, the aim was to optimize both the

used UAVs number and the distance to travel by proposing a declarative model of routing UAVs and MBSs. Nevertheless, this approach fit to only a few types of missions, in addition to the fact that the mobile swapping stations approach it is not always feasible. It should be mentioned that this study was focused on the routing task with no experiments, where the swapping was not discussed.

A critical analysis a the literature swapping approaches is proposed in Table 3.

Table 3: Critical evaluation of available swapping studies.

Ref.	Main Contribution	Advantages	Limitations
[107]	Multi-rotor aerial prototype for long-duration surveillance missions based on battery health monitoring.	Hardware prototype, the system can operate continuously, battery health considered.	No autonomous swapping, system operation managed by laptop rather than an embedded controller.
[99]	Design, test, and construction of an autonomous ground recharge station using a balancer and safer electrical contacts.	Hardware platform, autonomous swapping, embedded controller, optimization algorithm to reduce recharge duration.	No flight test conducted, battery health not considered.
[106]	Planning and learning algorithm developed and tested in 3h long persistent flight using three UAVs and more than 100 battery swaps.	Design and hardware implementation, automated refueling, flight test results	System cost not discussed, landing accuracy neglected.
[107]	Automated swapping mechanism including online algorithms to perform energy management, vehicle health monitoring, and accurate landing.	The constructed platform can maintain one UAV operating indefinitely, algorithms for precision landing and battery health tracking.	Entire system not tested.
[104, 105]	Autonomous docking platform design including active infrared imaging	Hardware platform, accurate and fast swapping (8 seconds), day/night time operation.	No flight test, endurance improvement not discussed.
[109]	Dual-drum structure to perform fast and efficient hotswapping.	Flight test, communication constraints considered.	Vehicle health not tracked, experiments limited to only 70 min as maximum mission time.
[22]	Declarative model of routing UAV multi-agent system and mobile battery swapping stations (MBSs) for delivery missions.	Optimization of the traveled distance and UAVs number.	Only computational results, no experimental validation, swapping technique was not discussed.
[103]	UAV positioning after landing with small error.	Precise UAV positioning for swapping regardless of landing error.	Relatively long swapping duration, entire system was not tested.

### 3.1.3. Laser-beam inflight recharging

The swapping approach seems a good solution to extend battery-based UAVs operating time with the ground station constraint for charging/replacing batteries. This consequently impacts UAVs mission flight time and operation efficiency. In this context, wireless recharging was proposed

as an alternative approach [23, 110].

The required ground station includes a prime power source to supply the laser generator, which transmits a light beam to the UAV while it is airborne. An embedded optical receiver converts light to electricity powering the UAV. This technology enables UAVs to stay in flight indefinitely without the need of landing to recharge batteries. When recharging is needed, the UAV joins an aerial power link area to receive energy. Thereby, safety is improved by eliminating takeoff and landing risks. Laser transmitters are deployed on rooftops of high buildings in order to avoid laser-beam obstruction or on a mobile station (Fig. 16). A radiative link will be established between the UAV and the nearest energy source to allow fast power transfer. A working prototype was developed by LaserMotive enabling a transfer of hundreds of watts [25]. In addition, experiments in [26] demonstrated the technique feasibility illustrating more than 12 h flight time for a quadcopter. In this study, where both the mechanical design and flight control system were presented, size, payload, and UAV adaptation to a specific application were considered.

The laser-beam inflight recharging approach constraints the UAV to operate at reduced heights and sometimes in a limited area to keep power transferring from the laser transmitter. In this context, the Federal Aviation Administration (FAA) regulations limit the maximum altitude for small UAVs to 400 feet [111]. This rule concerns to commercial and government UAVs weighing less than 26 kg. In addition, a laser transmitter is required for each UAV, therefore limiting the number of deployed UAVs in the area or considerably increasing the approach cost [23].

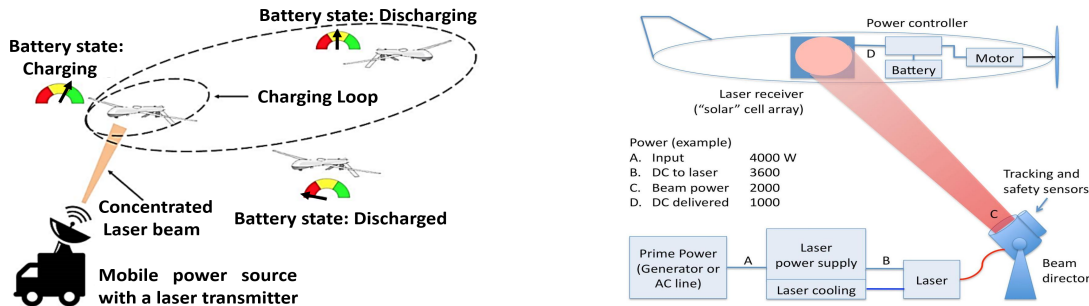

Figure 16: Laser-powered UAVs [110, 112].

### 3.1.4. Tethered UAVs

UAVs, when tethered to a power supply, can have unlimited autonomy. There will be no need to repeated recharging neither in the air nor by landing on the ground because electricity will be continuously provided by a ground power supply station through connection lines. This will also allow a safe and efficient data transfer between the UAV and the ground station. Generally

power lines are made of copper wires. However, fiber technology is taking place in the tethered-UAV area. Kilowatts of power can be transferred using high-intensity light in a fiber optic cable. Optical power decreases the detectability by eliminating the electrical signature. It can also reduce both battery payload and power lines weight up to eight-times than copper wire [113]. In addition, fiber technology is more beneficial in high altitudes. Indeed, with copper wires, power losses will reduce efficiency. Figure 17 provides illustrative two examples of tethered UAVs.

In [28], a tethered UAV is proposed for maritime pollution monitoring. It is deployed on the ship to detect oil spilled on the sea to avoid heavy contamination of the shore. In their patent, Woodworth et al. [29] outfitted a tethered UAV for data gathering applications. However, the major drawback of this approach is the limited operating area, the connecting cable prevents the UAV to fly far from its ground station. Sometimes a moving vehicle is used to carry the prime power source so that the UAV can cover a larger area. In [27], Gu et al. proposed a tethered UAV for extremely-long-endurance missions of nuclear power plants. It is targeted that the UAV flight may last for a few days or even a few months as long as the tethered cable provides continuous power. It is worth noting that prototypes were designed and successfully demonstrated in outdoor environments.

It has been above-presented and discussed UAVs battery-based power supplying techniques. Table 4 proposes then a critical comparison of the available literature on these techniques.

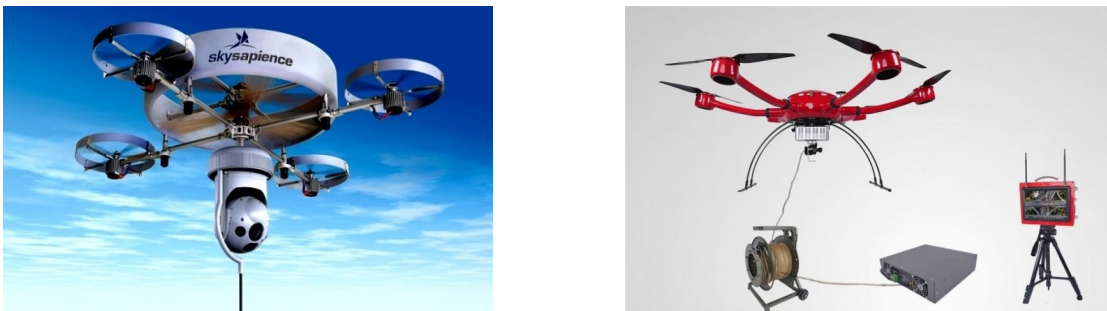

Figure 17: Tethered UAVs [114, 115].

### 3.2. Fuel Cell Powered UAVs

Hydrogen-powered UAVs, as illustrated by Fig. 18, can fly for hours instead of few minutes when traditional batteries are used [116]. For example, LiPo batteries possess specific energy up to 250 Wh/kg [20], while it can reach 1000 Wh/kg in case of a fuel cell system with a compressed hydrogen tank [19]. In addition, the refueling process is done almost instantly, while it (recharging) takes a long time with batteries.

Table 4: Comparison between battery-based supplying techniques.

<b>Power supplying technique</b>	<b>Advantages</b>	<b>Limitations and drawbacks</b>	<b>Related papers</b>
Swapping	Unlimited operating time, good option for long-range missions, uses only one energy source $\Rightarrow$ Weight and complexity of power management are extremely reduced.	Necessity of a ground station (GS), reduced operational efficiency, increased batteries and UAVs number $\Rightarrow$ high cost; concerns of cooperation between UAVs and the GS; issues in autonomous swapping: landing, battery changing operation.	[107, 23, 97, 98, 99, 100, 24, 102, 103, 106, 104, 105, 22]
Laser-beam charging	Unlimited operating time, wireless refueling, no need to land, one energy source, persistent missions, the operating range is extended.	Necessity of GS, reduced operating heights, constraints related to laser-beam obstruction, reduced range.	[23, 25, 26, 110]
Tethered UAVs	Unlimited operating time, no need to land, one energy source, safe and effective data transfer, persistent operation.	The necessity of GS, limited operating area, UAV damage in case of tethering loss.	[27, 28, 29]



Figure 18: MMC's HyDrone 1550 multicopter equipped with 1800W H1-Fuel Cell [117].

In [118, 92], three types of batteries, Li-ion, Ni-Cd, and Ni-Mh, beside fuel cell are compared and investigated considering some criteria such as energy and power densities, discharging characteristics, temperature effects, efficiency, and endurance. However, no flights test were conducted to study the power sources behavior during flights and to find out their capabilities and performances versus different airborne conditions. Figure 19, illustrating specific power vs specific energy for batteries, fuel cells, and supercapacitors, shows that fuel cells clearly outperforms the others sources in term of specific energy. They should therefore be considered as the solution of choice for higher endurance UAVs for a given weight [119]. Fuel cells may have lower energy density compared to Lithium batteries, as the hydrogen tank volume has to be considered (Fig. 20).

In [120], Belmonte et al. investigated the development of a UAV for mobile crane inspection.

They have considered proton exchange membrane fuel cells and lithium-ion batteries and analyzed them from an economical point of view and a life cycle assessment. One of the main conclusion were that from a commercial point of view, fuel cells, being a niche product, are more expensive compared to the Li-ion battery.

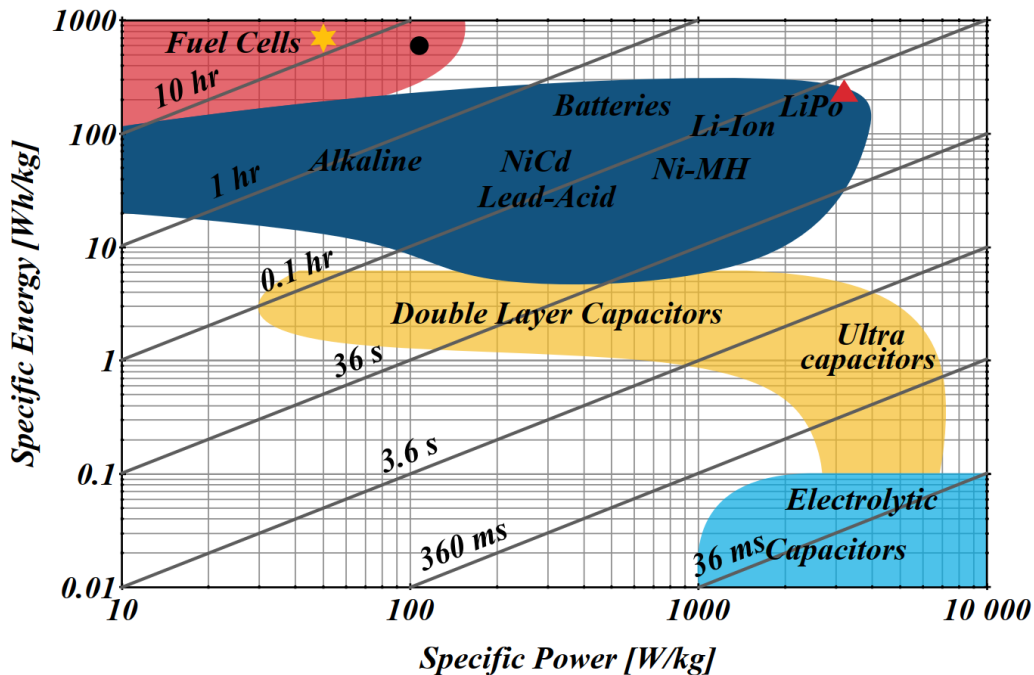

Figure 19: Specific energy/power comparison between energy sources [118].

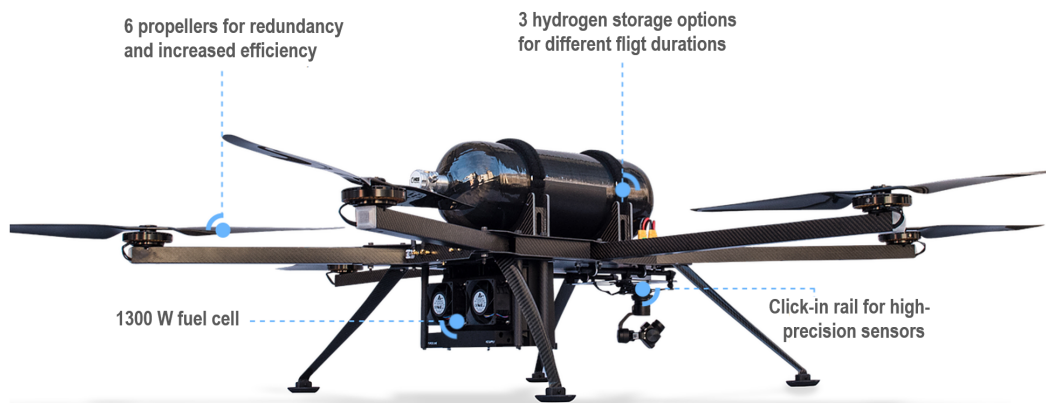

Figure 20: The Hycopter UAV from HES [121].

### 3.2.1. Fuel cells efficiency issue

Elements on the process of electricity generation from fuel cells can be found in [116]. In term of efficiency, fuel cells can reach a level as high as 60% [122]. It is unfortunately lower than that of lithium batteries (over 90%). Indeed, a fuel cell stack operation requires auxiliary equipment,

which reduces efficiency, while the onboard hydrogen generation system increases complexity (Fig. 21) [116].

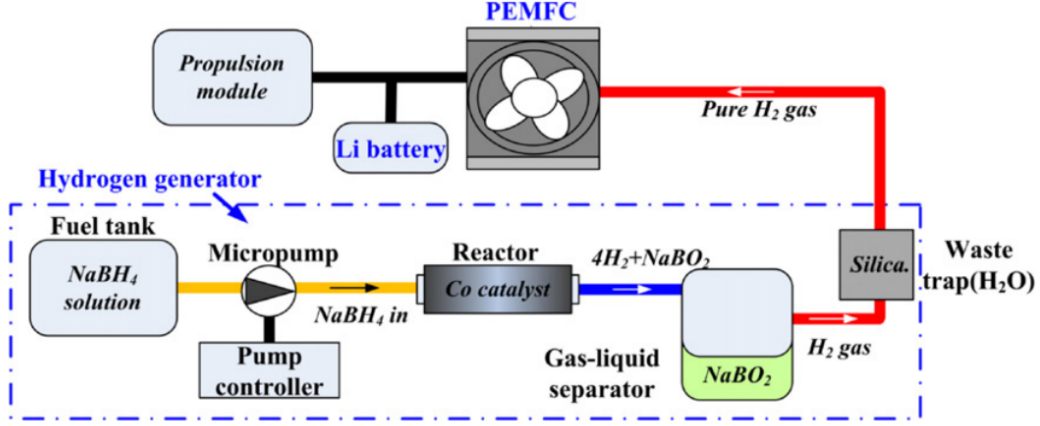

Figure 21: Fuel cell system auxiliaries illustration [123].

### 3.2.2. Fuel cell types

Many technologies are used in the fuel cell industry. They are typically classified according to chemical criteria such as catalysts, and electrolytes, or operating characteristics such as temperature. In their study [16], Gong et al. propose a brief comparison between most used fuel cell types in UAVs, namely polymer electrolyte membrane fuel cell (PEMFC), direct methanol fuel cell (DMFC), and solid oxide fuel cell (SOFC), where Table 5 summarizes their main key characteristics.

Table 5: Key features of most used fuel cell types in UAVs [124, 125, 126, 127]

Fuel cell type	Fuel	Efficiency (%)	Temp. ( $^{\circ}C$ )	Stack specific power (W/kg)	System specific power (W/kg)
PEMFC	Hydrogen	40-60	30-100	>500	>150
DMFC	Methanol	20-30	20-90	>70	>50
SOFC	Hydrocarbon	30-50	500-1000	>800	>100

PEMFC seems to be the most commonly used type for UAVs propulsion system [116]. Indeed, Intelligent Energy, which is a fuel cell development company, focused on manufacturing PEMFC for UAVs applications [128]. Indeed, this fuel cell technology has typical characteristics such as: lightweight, high power density, low operating temperature allowing less warm-up time, long



lifetime, and low response time to load variation [16, 129].

Table 6 proposes some examples of fuel cell-powered research and industrial UAVs.

Table 6: Fuel cell-powered UAVs.

Organisation	UAV name	UAV type	Fuel cell type	Hydrogen storage type	Endurance
EnergyOr (2011)	FAUCON H <sub>2</sub>	Fixed wing	PEM	Compressed H <sub>2</sub>	10 h 04 min
U.S. Naval Research Laboratory (2013)	Ion Tiger	Fixed wing	PEM (550 W)	Cryogenic liquid H <sub>2</sub>	48 h
EnergyOr (2016)	H <sub>2</sub> Qauad 1000	Multicopter	PEM (900 W)	Compressed H <sub>2</sub>	2 h
SKYCORP (2018)	e-Drone Zero	Multicopter	PEM (800 W)	Compressed H <sub>2</sub> (3 l, 300 bar)	2 h
BATCAM (2019)	/	Multicopter	PEM	Compressed H <sub>2</sub> (6 l)	70 min (with 5 kg payload)
MetaVista (2019)	/	Multicopter	PEM (800 W)	Liquide H <sub>2</sub> (6 l)	12 h 07 min

### 3.2.3. Fuel storage

Hydrogen has a density of only 0.089 kg/m<sup>3</sup> at standard temperature and pressure [16]. Hence, to enable UAV carrying sufficient fuel for a given mission, tanks must be bulky [130] (Fig. 22). This is an important constraint regarding an UAV size and weight. Furthermore, safety reasons, there is no possibility to store pure hydrogen under extremely high pressure and low temperature [131].

There are mainly three techniques that are currently used to store hydrogen in UAVs [16]: Compressed hydrogen gas, liquid hydrogen, and chemical hydrogen generation. Each of these storage techniques has its advantages and drawbacks, which are analyzed and discussed in Tables 7 and 8.

The literature on hydrogen storage shows a variety of approaches. In [138], Swider-Lyons et al. provided a comparative study considering qualitative and quantitative criteria to select the best hydrogen storage method for a 24 hours flight performed by the Ion Tiger UAV. However, based on practical and flight-tested prototypes developed by several research teams (EnergyOr) [126], Naval



Figure 22: Fuel cell storage tank constraint illustration [132].

Table 7: Comparison between compressed and liquid hydrogen storage.

	Compressed $H_2$	Liquid $H_2$
<b>Properties</b>	<ul style="list-style-type: none"> <li>- Most used</li> <li>- Storage pressures: 35-70 MPa [133]</li> <li>- Density: 42 kg/m<sup>3</sup> at 70 MPa [134]</li> </ul>	<ul style="list-style-type: none"> <li>- Density: 71 kg/m<sup>3</sup> at 1 bar and -252.87 °C</li> <li>- A thermal insulation is needed to keep a very low temperature</li> <li>- Fit on large scale applications</li> </ul>
<b>Advantages</b>	<ul style="list-style-type: none"> <li>- Simple</li> <li>- Low storage mass penalty</li> <li>- Rapid refueling capability</li> </ul>	<ul style="list-style-type: none"> <li>- Increased safety</li> <li>- High density</li> <li>- Reduction of tank weight</li> </ul>
<b>Disadvantages</b>	<ul style="list-style-type: none"> <li>- Very low storage efficiency</li> <li>- Safety risks</li> <li>- System larger volume</li> </ul>	<ul style="list-style-type: none"> <li>- High liquefaction energy <math>\Rightarrow</math> Costly process</li> <li>- Impractical small-scale production</li> <li>- Liquefaction requires very low temperature.</li> <li>- Difficult handling</li> </ul>

Table 8: Chemical hydrogen generation techniques comparison.

	Sodium borohydride	Ammonia borane	Liquid hydrocarbons
	$NaBH_4 + 2H_2O \rightarrow 4H_2 + NaBO_2$	$NH_3BH_3 \rightarrow NH_2BH_2 + H_2$	$CH_2O_2 \rightarrow H_2 + CO_2$
<b>Properties</b>	<ul style="list-style-type: none"> <li>- Catalyst is required</li> <li>- Widely used for UAVs</li> <li>- React at 80-120 °C [16]</li> </ul>	<ul style="list-style-type: none"> <li>- Dehydrogenation at 120-180 °C [135]</li> </ul>	<ul style="list-style-type: none"> <li>- A proper catalyst must be used to eliminate carbon monoxide</li> </ul>
<b>Advantages</b>	<ul style="list-style-type: none"> <li>- Stable, and fast reaction at ambient temperature</li> <li>- The high <math>H_2</math> weight fraction [136]</li> <li>- Low hydrolysis heat</li> <li>- Easy to handle</li> </ul>	<ul style="list-style-type: none"> <li>- High hydrogen storage capacity (19.6%) [16]</li> <li>- Stable under ambient conditions [137]</li> </ul>	<ul style="list-style-type: none"> <li>- High volumetric and gravimetric efficiency</li> <li>- Storage is easy to handle</li> <li>- High rates of hydrogen production at ambient temperatures</li> </ul>
<b>Disadvantages</b>	<ul style="list-style-type: none"> <li>- The hydrogen generator is needed <math>\Rightarrow</math> increase in weight</li> <li>- <math>NaBO_2</math> precipitation issue</li> <li>- By-product tank is needed</li> </ul>	<ul style="list-style-type: none"> <li>- Slow reaction</li> <li>- Liberation of gaseous impurities</li> <li>- Extensive material expansion and foaming</li> </ul>	<ul style="list-style-type: none"> <li>- Carbon monoxide poisons the PEMFC</li> </ul>

Research Laboratory [139, 140], Boeing RD Europe [141, 142, 143], Florida Solar Energy Center [144], it can be concluded that liquid  $H_2$  is not a suitable solution due to constraints related to its infrastructure [16]. Even if in another research at the Colorado State University [145], a fuel cell powered UAV was designed to reach more than 24 hours flight-test using compressed hydrogen. Regarding chemical hydrogen generation, it typically needs extra equipment for hydrogen extraction therefore leading to a heavy and complex power supply system. Furthermore, hydrogen extraction is time-consuming therefore impacting the UAV response-time to load changes. In [20], Kim and Kwon presented performance analysis of a fuel system with a hydrogen generator powering a small UAV under real flight test of 2 hours. In this context, stack and reactor temperatures, hydrogen generation rate, and fuel cell output power were evaluated under varied power demand. This study validated the fuel cell ability to power a successful flight. However, some related issues have been highlighted, such as startup time, catalyst durability, and clogging caused by the by-product.

Furthermore, the developed system in [138] based on Protonex 550 W PEM fuel cell proved by a flight test 6 times endurance increase than Li-ion battery system.

### *3.3. Hybrid Power Sources*

#### *3.3.1. Fuel cell and battery*

Despite their performances and technological advancements, fuel cells have some limitations when used as a unique power source for UAVs. Indeed, a fuel cell is characterized by a large time-constant (in the order of seconds) since it needs to be supplied by fuel and air using pumps, valves, and compressors. The slow response is mainly due to pumps mechanical characteristics, flow delay, thermodynamic characteristics, and the capacitance effect [146]. Thus, in case of high variation in current demand, fuel starvation problem can occur, which can affect lifetime, reliability, and efficiency [147]. Combining a fuel cell with battery to form a hybrid power supply system seems therefore to be a good option that enables the UAV propulsion system to benefit from advantages of both sources and to balance their drawbacks [148, 92, 120].

Indeed, battery since it has higher power density, faster response, and higher efficiency than a fuel cell, will be selected to supply the required peak-power, when UAV conducts typical maneuvers such as take-off and climbing. The fuel cell will afterward be the main supply in in cruise or descend periods. It can also charge the battery to keep the SOC higher than the prescribed threshold.

In [149], Verstraete et al. discussed the performances of a hybrid UAV propulsion system powered by a 200 W fuel cell and a battery by mean of hardware-in-the-loop (HIL) simulations.

The behavior of each source under different tests was highlighted and analyzed. This study also considered endurance and hydrogen use. In a similar study in [150], HIL-based on real flight recorded data was performed under different load fluctuation degrees. In [151], the authors focused their study on the battery contribution to the hybrid system. Their experimental investigation emphasizes the performances of the battery under several solicitations that can be undergone during flight mission phases. Detailed characterization of this propulsion system is presented in [152], using different mission profiles and speeds. However, the energy management strategy was not developed in these studies as power splitting was only conducted by a passive method.

### *3.3.2. Solar cells as an auxiliary power source*

Application of photovoltaic (PV) generation system in moving carriers, such as UAVs is receiving considerable attention. In this case, a UAV outfitted by PV arrays on its wings can indefinitely fly providing that a battery is installed for energy storage to supply at night or in case of sun availability [21]. Solar powered-UAV are typically designed and widely used for HALE applications as illustrated by Fig. 23. HALE UAVs are designed to perform persistent missions (more than 1 day) at a very high altitude. Morton et al. [153] proposed a solar-powered UAV design method to optimize the airframe efficiency. The experimental tests on the developed prototype have shown that the amount of solar energy received was sufficient for the UAV to carry the additional payload of the solar system extending its endurance [153].

In [154], Harvey et al. proved that using PVs might enable up to 59% of fuel savings in addition to reducing the UAV weight. Then, exploiting solar energy is a relevant contribution to UAV endurance improvement. As shown by Fig. 23, solar powered-UAVs must have large wings in order to maximize the amount of received light energy. In this context, a maximum power point tracking (MPPT) algorithm is required [155]. In this context, the MPPT hardware system includes a simple converter associated with a low-cost microcontroller, current, and voltage sensors. In [21], Shiau et al. proposed the design and validation of a solar power management system (SPMS) for their experimental UAV powered by solar cells and batteries. The SPMS includes three cascaded stages: An MPPT stage to maximize the PV power under temperature and solar radiation variability. Then, the battery management block controlling energy storage and delivery. The last stage is the DC/DC converter providing +5 V and +12 V power sources and supplying all the onboard electronic circuitries. However, this study does not consider the propulsion power in both energy management process and design. In [155], Pen et al. have

proposed an interesting perturb and observ-based MPPT algorithm to achieve high efficiency for PV systems under fast multi-changing solar irradiances, which could be the case of UAVs.

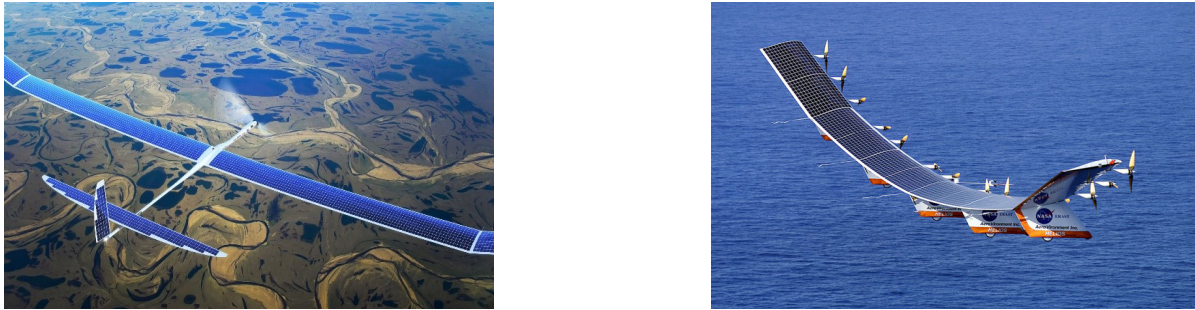

Figure 23: Solar-powered UAVs [156, 157].

### 3.3.3. Supercapacitor as an auxiliary power source

Supercapacitors are recently attracting attention as faster energy storage systems are needed in a number of applications to replace or complement batteries, which suffer from sluggish charge/discharge with a limited lifetime [158].

A supercapacitor is characterized by a much higher power and much lower energy densities when compared to a battery. In addition, it operates in a large temperature range, with overcharge tolerance, low maintenance cost, and a reasonable cost [159]. It can also extremely reduce the DC bus voltage fluctuations. Table 9 provides a comparative analysis of batteries and supercapacitor main characteristics.

In this context, integrating a supercapacitor as an additional power in a UAV hybrid power supply will offer an additional degree of freedom in term of supplying architectures, while reinforcing power density and allowing rapid power response (Fig. 24). In hybrid power supply architecture, the fuel cell is typically the main power source, while the others are auxiliary ones. The fuel cell will therefore be selected to power the UAV steady state therefore extending its lifetime [161]. In this case an EMS is mandatory to enable each power source working in its optimal condition.

In [17], Gong et al. provided a HIL-based evaluation and analysis of a hybrid UAV propulsion system including fuel cell, battery, and supercapacitor. The system was compared to a fuel cell/battery system under a flight profile to find out the role of the supercapacitor. In addition, the effect of supercapacitor capacity on fuel cell and supercapacitor behaviors were studied. The achieved results have shown good performance of the supercapacitor in load smoothing and dynamic response. In an additional work on the same UAV configuration [162], the authors conducted two flight tests with a real UAV prototype (Fig. 24). It has been therefore clearly shown the su-

Table 9: Comparison between batteries and supercapacitor [160].

Type	Energy density (Wh/kg)	Power density (W/kg)	Cycle life (Times)	Efficiency (%)	Merits	Drawbacks
Lead-acid battery	30-40	200-300	300-400	75	Low cost, high discharging rate, and high recycling rate.	Poor performance at low temperature.
Ni-MH battery	60-80	800-1500	1000	75	High energy density, high charging and discharging speed, and long lifetime.	High self-discharging rate, need for a cooling system, and higher manufacturing cost.
Li-ion battery	100-120	600-2000	1000	90	High voltage, high energy density, lightweight, long cycle life, low self-discharging rate, no memory effect, and no pollution.	Lifetime decrease at high temperature, non-overcharge, non-over discharge, and high security requirement.
Supercapacitor	4-15	1000 - 10,000	100,000	85-98	Fast charging and discharging speed, pollution-free and extremely long life.	Low energy density.

percapacitor considerable contribution in delivering peak power and absorbing power fluctuations during a dynamic flight with rapid changes in power load. The DC bus voltage stabilization has been also shown. The EMS strategy has not been unfortunately discussed.

A critical comparative analysis on UAV hybrid power supply configurations is proposed in Table 10.

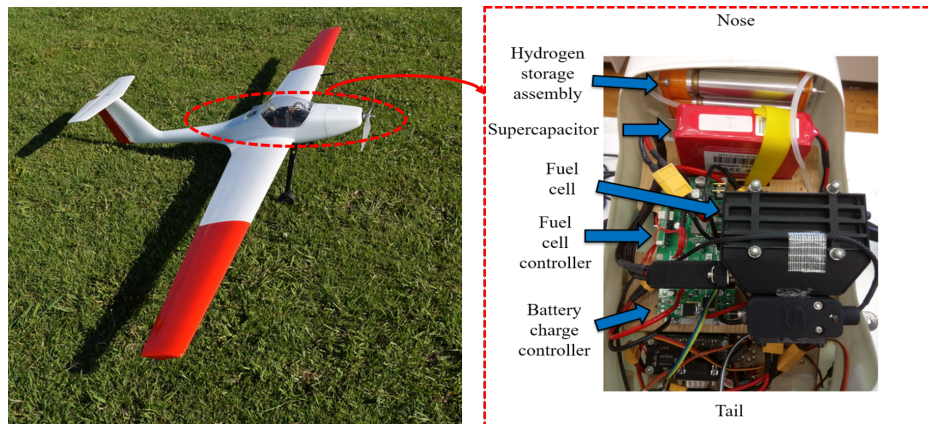

Figure 24: A hybrid fuel cell-battery-supercapacitor power supply in a UAV [17, 162].

Table 10: Comparison of power supply configurations.

Energy sources	Architecture	Advantages	Limitations and drawbacks	Related papers
Thermal energy	Gas turbine engine	High power-to-weight ratio and long operating time.	Very bad fuel economy and high noise level.	[85, 86]
	ICE	Very high power and energy densities, high endurance, large payload range.	Reduced efficiency, thermal and acoustic signatures, GHG emission, fuel high cost.	[11, 10, 12, 13]
One electrical source	Battery	High energy density, energy stored (not generated) $\Rightarrow$ quick response to power demand.	Low power density, reduced endurance, long recharging time with ‘memory effect’ for some battery types, to increase autonomy $\Rightarrow$ add more batteries $\Rightarrow$ increase weight and cost.	[94, 95]
	Fuel cell	High energy density, instantly refueling without ‘memory effect’, to increase autonomy $\Rightarrow$ use more fuel in the same stack (weight reduction).	Energy generated $\Rightarrow$ slow response to power demand, auxiliary equipment are required (compressors, regulator, etc), lack of infrastructures for hydrogen distribution, issues of hydrogen storage, safety concerns, hydrogen production high cost.	[20, 19, 138]
Hybrid power supply	Fuel cell and Battery	Hight energy and power densities $\Rightarrow$ increase in the endurance and the response time, energy generation and storage.	Increase of weight, EMS is needed (controllers and converters) $\Rightarrow$ additional weight and complexity.	[20, 151, 163, 164, 165, 149, 150, 166]
	Fuel cell, Battery, and solar cells	Additional energy source $\Rightarrow$ endurance improvement, clean, free and available energy $\Rightarrow$ decrease in energy cost, hydrogen saving.	Necessity of large UAV wings, cannot be used in rotary-wing UAVs, an energy storage device is needed, EMS and MPPT are required.	[87, 21, 167] [168, 169, 170]
	Fuel cell, Battery, and supercapacitor	Very high power density, fast charging, reduced weight, and reduced dc bus fluctuations; very long lifetime, minimum heat loss due to the reduced internal resistance.	EMS is needed, supercapacitor voltage regulation is necessary.	[17, 162]

#### 4. Power Management Strategies

Hybridization is the most suitable architecture to power the propulsion system in UAVs. It allows combining advantages and performances of different power sources, and balancing their limitations. Thus, power has to be optimally split between sources to achieve an efficient energy usage and to enable power sources high performance operation, while extending as long as possible their lifetime. Thereby, a power management system or strategy (PMS) must be implemented for power real time splitting among the available sources, while considering constraints such as efficiency, fast response, fuel consumption, required power, and flight conditions. This approach is

an active power management strategy, where the power outputs are controlled through converters by the energy management unit. Power can also be supplied using a passive method, which is widely used for small UAVs as in [171] and [172]. In this case, the power sources are directly connected to a DC link and supply the propulsion according to their own characteristics. Neither additional power converters nor controllers are needed, therefore considerably reducing complexity, weight, and power losses [167]. Hardware architectures of both passive and active PMSs are depicted in Fig. 25.

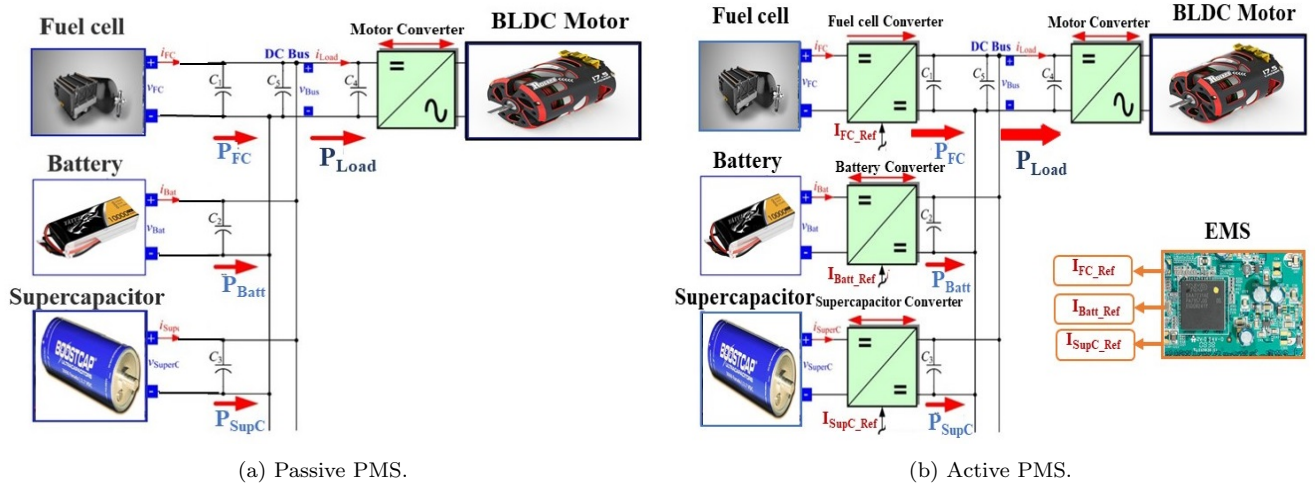

Figure 25: Active vs passive PMS Architectures.

In [167], Lee et al. investigated benefits and drawbacks of both active and passive PMSs using flight test results and power simulation. The studied hybrid power supply system is composed of a fuel cell, a battery, and solar cells. It is intended for low-speed long-endurance UAVs. Simulation results have shown that the passive PMS could not maintain the battery minimum SOC, therefore affecting its lifetime and increasing the system failure possibilities. On the other hand, power losses reached 4.7% when using an active PMS. In this context, the two PMSs were not evaluated in the same conditions. Indeed, the passive PMS was just simulated, while the active one was experimentally implemented. In addition, many flight related conditions were neglected. Table 11 presents a comparison between active and passive PMSs.

Hereafter, we will focus on the main active PMSs proposed in the literature for UAVs energy management.

#### 4.1. Rule-based Strategies

Rule-based control is one of the most widespread control strategies due to its simplicity, reliability in management using predefined conditions (if-then rules). It is typically characterized



Table 11: Comparison between active and passive PMS.

PMS	Advantages	Disadvantages
Active	- Optimized power usage	- Weight
	- Safety of power system	- Complexity
	- Efficiency	- Power losses in converters
	- No prior sizing to sources is needed	
Passive	- Simple	- Power distribution Low efficiency
	- Light	- Sources Reduced lifetime
	- Power losses are reduced	- Energy sources strict sizing required for reliable DC bus sharing

by a very low computational cost, enabling online EMS implementation [163]. In [167], Lee et al. investigated a PMS to control a UAV propelled by a hybrid power system including a fuel cell, a battery, and solar cells. The proposed PMS takes into account the required power and the battery SOC to assign each power source output. In this study, solar cells are used as the primary source since it requires no onboard fuel. The PMS considers power outputs as control variables and sets terminal voltage (20-36 V) of each source by means of DC-DC converters. The fuel cell supplies the UAV only in a defined power interval (50-180 W), to keep it working in nominal conditions. In parallel with the PMS, the battery management system prevents battery from overcharging when it is fully charged. A minimum SOC of 45% was prescribed for UAV safe operation.

In a recent paper [166], Yang et al. proposed a state machine strategy for a fuel cell/battery UAV. In this case a control logic divides the decision area into five states based on demand power and battery SOC values. The hybrid power system architecture includes two converters, where one is bidirectional to control battery charging/discharging. Furthermore, two PI controllers are used to regulate power and voltage references. To validate the proposed PMS, authors conducted experimental tests soliciting the power system by load profiles with different SOC initial conditions. This study was unfortunately not implemented in a real UAV and tested on ground.

In [170], Xian-Zhong et al. proposed an EMS based for a PV/battery-powered long-endurance UAV. In a first phase, the available PV energy is split into three parts, where the first one powers the UAV, the second one is stored to be used in a next phase, and the last part is used to charge the battery. The second phase starts when solar irradiance decreases. In this case, the UAV power deficit is covered in part by the stored energy and the use of gravitational gliding. The last phase, in case of a total solar power deficit, the battery powers the UAV at low altitude and enable a safe landing (end of mission). In this simulation study, the proposed PMS considers the wind effect and has shown about 23.5% of energy conservation in comparison with another management strategy.

The availability of such kind of UAV is unfortunately strongly dependent on solar energy.

In a recent study [168], Gang and Kwon proposed a power switching technique based on inter-changing power supply between a PV system (including a battery) and a fuel cell-based one. Solid-state relays are used to select either the most suitable power source or both, according to their states, power requirements, and flight conditions. When the PMS activates the fuel cell system, it delivers the load power, while the PV system is switched to standby mode. In this period, the generated PV power is used to charge the battery. The authors designed and constructed their hybrid UAV, and they conducted a flight test over a period of 1.5 h. However, neither the switching rules nor the control algorithm were explained.

In [173], Savvaris et al. proposed a simple rule-based algorithm to control a battery/fuel cell hybrid system. Power is adopted as a variable of control instead of current. Relays are used to either activate or deactivate each source power flow. In this context, three operation modes have been considered: The parallel mode, when the two sources are supplying the UAV; the charging mode, when the battery is charging; and the load following mode (between the previous modes). Beside simulations, HIL-based experiments were carried out. However, there were no flight test with a real UAV and the endurance issue has not been discussed.

A constrained thermostat control (CTC) strategy was proposed in [87]. The algorithm set solar cells as the primary source, which can charge the battery in case of extra power. Furthermore, the strategy keeps a low threshold SOC of the battery (30%) during flight to ensure safe landing when solar cells and the fuel cell cannot cover the necessary power. The battery contributes to the power supplying as long as the SOC is higher than the prescribed threshold. This was a simulation-based study that needs at least HIL-based validation.

#### *4.2. Fuzzy Logic Strategies*

A fuzzy logic-based PMS can be implemented to enhance power allocation for an UAV hybrid power supply system increasing energy efficiency. The fuzzy control algorithm uses inputs such as battery SOC, power demand ( $P_D$ ), and photovoltaic power (if PV panels are used); and then generates control commands (i.e. fuel cell power  $P_{FC}$ ) respecting the pre-set rules. These rules determine the management strategy and set priorities and constraints. In general, PV power has the highest priority to supply the UAV, while fuel cell power has the lowest one. Table 12 shows an example of fuzzification for a battery/fuel cell control system [164]. The battery SOC is classified as: low (L), medim (M), and high (H), respectively. The power demand  $P_D$  has five fuzzy states:

medium (M), high (H), very high (VH), low (L), and very low (VL). Similarly, the fuzzy output  $P_{FC}$  has five fuzzy states: M, VH, H, L, and VL.

Table 12: Fuzzificationn for a battery/fuel cell power control system [164].

$P_{FC}$	$P_D$					
	VH	H	M	L	VL	
L	VH	VH	H	M	L	
$SOC$	M	VH	H	M	L	L
H	H	M	L	VL	VL	

In [164], Zhang et al. proposed an online fuzzy EMS for a UAV propelled by a hybrid fuel cell/battery power system. The designed EMS was experimentally tested. In this study, the fuel cell supplies the propulsion through a programmable DC/DC converter, which controls its current output. The battery is directly linked to the DC bus with no converter. Its output current is in this case indirectly determined by the power balance principle. The implemented algorithm uses the battery SOC and the power demand as input variables and calculates, under a fuzzy process, the fuel cell power as the output variable. The fuzzy EMS was compared with state machine and passive control strategies, using three types of flight missions: pulsed-power mission, flight-power mission, and long endurance mission. The proposed management strategy shows good performance regarding fuel consumption and battery SOC. However, it was implemented in a test-bench using programmable electric load to emulate power demand profiles. No real flights were carried out.

In [163, 165], Karunarathne et al. proposed an energy and power management system to optimize power splitting between a PEMFC cell and a Li-ion battery. In the first stage, the EMS aims to reduce oxygen concentration voltage losses. It makes long term decisions based on the required power, the battery SOC, and the PEMFC control parameters. In the second stage, the PMS receives those decisions and deals with a short-time implementation. The PMS uses a rule-based system to define the PEMFC output through a unidirectional converter and controls the DC/DC bidirectional converter to enable the battery charging/discharging by switching it to buck/boost modes. The EMS acts on the PEMFC compressor motor voltage to control the inlet airflow rate. To set the compressor voltage into optimum value, an ANFIS-based (Adaptive Neuro-Fuzzy Inference System) adaptive controller is used to predict the membership function estimation parameters. However, this study is still at the simulation stage with no experimental investigations.

In [169], Zhang et al. introduced a hybrid approach combining fuzzy logic and state machine strategies. The fuzzy logic strategy is used for power allocation for the UAV battery and fuel cell, when the state machine strategy is in charge of power management for the solar cells and battery. A mission scenario was implemented in a simulation platform to study the power sources behaviors. The proposed strategy was compared to the thermostat control strategy [87], implemented for the similar UAV. The carried out comparison considers the battery SOC, fuel utilization, and each source contribution proportion in the supplying process.

Far from the rule-based and fuzzy logic EMS/PMS approaches, an optimal EMS using dynamic programming was introduced in [174]. The proposed algorithm was tested with several flight scenarios and different hybridization degrees (batteries contribution in power supplying), and considering fuel consumption. The investigations aimed to determine the best architecture regarding endurance improvement. This study leads to the main conclusion that hybridization can be beneficial in term of endurance only in case of the fuel cell inability to ensure the UAV supplying as a unique source. The computational complexity of such an optimal method may be an obstacle for online usage.

A critical comparative analysis of UAV EMS/PMS main literature is proposed in Table 13.

## **5. Conclusions and future trends**

UAVs have been in continuous development and they are reaching a large range of applications. In this context and as the propulsion system constitutes the mainstay of a UAV platform, this paper have been focused on the onboard propulsion system energy aspect by proposing a comparative and critical state of the art review on UAVs power supplying architectures and suitable energy/power management strategies. This comparative and critical study intends providing a starting basis for the development of performing UAV power propulsion systems by facilitating trade-off in the choice of power sources. One source-based UAV power supply system will be greatly limited because of their poor performance under varying operating conditions. Thus, hybridization of power sources with different characteristics is becoming a standard solution in designing a UAV electric power system. In this context, hybrid power sources choice and sizing are strongly depending on UAV's tasks and corresponding weight/duration constraints.

This paper also discussed the issue of unlimited endurance for specific missions. Indeed, it has been presented and discussed typical UAVs power supplying techniques, namely swapping,

Table 13: Power management strategies proposed for UAVs.

Ref.	Power supply system	Experiments/ Simulations	Contribution	Limitations
[167] 2014	FC/ Battery/ Solar cells	Experiments	Flight test for 3.8 h of an implemented rule-based PMS in 200 W class UAV.	Night operation not tested.
[166] 2018	FC/ Battery	Both	State machine strategy tested in different SOC conditions.	Only ground test.
[168] 2018	FC/ Battery/ Solar cells	Experiments	Switching technique between solar and fuel cell systems.	Strategy algorithm missed.
[21] 2009	Battery/ Solar cells	Experiments	Battery management in a solar system to power the electronic circuits in a designed UAV.	Power for propulsion system neglected.
[164] 2018	FC/ Battery	Experiments	Online fuzzy rule-based EMS using one programmable DC/DC converter.	No flight test.
[163, 165] 2010,2009	FC/ Battery	Simulations	Intelligent EMS and PMS using ANFIS-based controller.	Strategy not tested with UAV profile mission.
[87] 2012	FC/ Battery/ Solar cells	Simulations	Constrained thermostat control (CTC) strategy.	The proposed architecture may make the system heavy.
[169] 2018	FC/ Battery/ Solar cells	Simulations	Combination of fuzzy logic and state machine strategies.	No experimental validations.
[173] 2016	FC/ Battery	Both	HIL simulation of simple rule-based algorithm.	No flight test, endurance not discussed.
[23] 2013	Solar cell/ Battery	Simulations	Three-stage EMS for solar-powered UAV.	High dependence on solar energy.
[174] 2009	FC/ Battery	Simulations	Optimal EMS using dynamic programming.	Optimization high computational cost.

laser-beam inflight recharging, and UAV tethering. As it has been clearly shown in the state of art review, there are few EMS/PMS specific approaches for UAVs in comparison to electric vehicles. This is mainly due to UAVs specificities and constraints, while there were only few flight test studies investigating energy management strategies. In this context, the problem of energy optimization is hardly constrained by the UAV weight that limits the onboard computational capacity for real-time optimization, in addition to the fact that embedded processors need to be supplied, therefore affecting the endurance. In this context, off-line optimization could be considered as a trend, when many constraints of on-line optimization can be overcome. Indeed, recent works proposed UAVs energy consumption prediction based on an a priori knowledge of the scheduled mission (profile, maneuvering actions, duration, etc.) [175, 176].

## References

- [1] P. Liu, A. Y. Chen, Y.-N. Huang, J.-Y. Han, J.-S. Lai, S.-C. Kang, T.-H. Wu, M.-C. Wen, M.-H. Tsai, A review of rotorcraft Unmanned Aerial Vehicle (UAV) developments and applications in civil engineering, *Smart Structures and Systems* 13 (6) (2014) 1065–1094 (Jun. 2014). doi:10.12989/sss.2014.13.6.1065.
- [2] N. Adnan, S. M. Nordin, M. A. bin Bahrudin, Sustainable interdependent networks from smart autonomous vehicle to intelligent transportation networks, in: *Sustainable Interdependent Networks II*, Springer, 2019, pp. 121–134 (2019).
- [3] C. Kyrkou, S. Timotheou, P. Kolios, T. Theocharides, C. Panayiotou, Drones: Augmenting our quality of life, *IEEE Potentials* 38 (1) (2019) 30–36 (Jan 2019). doi:10.1109/MPOT.2018.2850386.
- [4] M. Mazur, A. Wisniewski, J. McMillan, Clarity from above: PwC global report on the commercial applications of drone technology, Warsaw: Drone Powered Solutions, PriceWaterhouse Coopers (2016).
- [5] T. DRONEII.com, TOP20 Drone Service Provider Ranking, (Accessed on 14-04-2019) (Mar. 2018).
- [6] M. Hassanalian, A. Abdelkefi, Classifications, applications, and design challenges of drones: A review, *Progress in Aerospace Sciences* 91 (2017) 99–131 (May 2017). doi:10.1016/j.paerosci.2017.04.003.
- [7] H. Shakhatreh, A. Sawalmeh, A. Al-Fuqaha, Z. Dou, E. Almaita, I. Khalil, N. S. Othman, A. Khreishah, M. Guizani, Unmanned Aerial Vehicles: A Survey on Civil Applications and Key Research Challenges, arXiv:1805.00881 [cs] (Apr. 2018). arXiv:1805.00881.
- [8] K. P. Valavanis, G. J. Vachtsevanos, *Handbook of unmanned aerial vehicles*, Springer, 2015 (2015).
- [9] M. Jaeger, D. Adair, Conceptual design of a high-endurance hybrid electric unmanned aerial vehicle, *Materials Today: Proceedings* 4 (3) (2017) 4458–4468 (2017).

- [10] E. Bongiorno, F. Mastroianni, M. Tomaselli, V. G. Monopoli, D. Naso, Model and energy management system for a parallel hybrid electric unmanned aerial vehicle, in: 2017 IEEE 26th International Symposium on Industrial Electronics (ISIE), IEEE, Edinburgh, United Kingdom, 2017, pp. 1868–1873 (Jun. 2017). doi:10.1109/ISIE.2017.8001534.
- [11] R. R. Glasscock, J. Y. Hung, L. F. Gonzalez, R. A. Walker, Multimodal hybrid powerplant for unmanned aerial systems (uas) robotics, In: Twenty-Fourth Bristol International Unmanned Air Vehicle Systems Conference, March 30th to April 1st 2009, Bristol United Kingdom. (2009).
- [12] Y. Xie, A. Savvaris, A. Tsourdos, Fuzzy logic based equivalent consumption optimization of a hybrid electric propulsion system for unmanned aerial vehicles, *Aerospace Science and Technology* 85 (2019) 13–23 (2019).
- [13] T. Donato, L. Spedicato, Fuel economy of hybrid electric flight, *Applied energy* 206 (2017) 723–738 (2017).
- [14] N. Adnan, S. M. Nordin, I. Rahman, P. Vasant, M. A. Noor, An overview of electric vehicle technology: a vision towards sustainable transportation, in: *Intelligent Transportation and Planning: Breakthroughs in Research and Practice*, IGI Global, 2018, pp. 292–309 (2018).
- [15] I. Burch, J. Gilchrist, Survey of global activity to phase out internal combustion engine vehicles, Center of Climate Protection: Santa Rosa, CA, USA (2018).
- [16] A. Gong, D. Verstraete, Fuel cell propulsion in small fixed-wing unmanned aerial vehicles: Current status and research needs, *International Journal of Hydrogen Energy* 42 (33) (2017) 21311–21333 (Aug. 2017). doi:10.1016/j.ijhydene.2017.06.148.
- [17] A. Gong, R. MacNeill, D. Verstraete, J. L. Palmer, Analysis of a Fuel-Cell/Battery/Supercapacitor Hybrid Propulsion System for a UAV using a Hardware-in-the-Loop Flight Simulator, in: 2018 AIAA/IEEE Electric Aircraft Technologies Symposium, American Institute of Aeronautics and Astronautics, Cincinnati, Ohio, 2018 (Jul. 2018). doi:10.2514/6.2018-5017.
- [18] P. Panagiotou, S. Fotiadis-Karras, K. Yakinthos, Conceptual design of a blended wing body male uav, *Aerospace Science and Technology* 73 (2018) 32–47 (2018).

- [19] D. Verstraete, K. Lehmkuehler, K. C. Wong, Design of a Fuel Cell Powered Blended Wing Body UAV, in: Volume 1: Advances in Aerospace Technology, ASME, Houston, Texas, USA, 2012, p. 621 (Nov. 2012). doi:10.1115/IMECE2012-88871.
- [20] T. Kim, S. Kwon, Design and development of a fuel cell-powered small unmanned aircraft, International Journal of Hydrogen Energy 37 (1) (2012) 615–622 (Jan. 2012). doi:10.1016/j.ijhydene.2011.09.051.
- [21] Jaw-Kuen Shiau, Der-Ming Ma, Pin-Ying Yang, Geng-Feng Wang, Jhij Hua Gong, Design of a Solar Power Management System for an Experimental UAV, IEEE Transactions on Aerospace and Electronic Systems 45 (4) (2009) 1350–1360 (Oct. 2009). doi:10.1109/TAES.2009.5310303.
- [22] G. Bocewicz, P. Nielsen, Z. Banaszak, A. Thibbotuwawa, A Declarative Modelling Framework for Routing of Multiple UAVs in a System with Mobile Battery Swapping Stations, in: Intelligent Systems in Production Engineering and Maintenance, Vol. 835, Springer International Publishing, Cham, 2019, pp. 429–441 (2019). doi:10.1007/978-3-319-97490-3\_42.
- [23] B. Galkin, L. A. DaSilva, UAVs as Mobile Infrastructure: Addressing Battery Lifetime, arXiv:1807.00996 [cs] (Jul. 2018). arXiv:1807.00996.
- [24] A. Williams, O. Yakimenko, Persistent mobile aerial surveillance platform using intelligent battery health management and drone swapping, in: 2018 4th International Conference on Control, Automation and Robotics (ICCAR), IEEE, Auckland, 2018, pp. 237–246 (Apr. 2018). doi:10.1109/ICCAR.2018.8384677.
- [25] J. Ouyang, Y. Che, J. Xu, K. Wu, Throughput Maximization for Laser-Powered UAV Wireless Communication Systems, arXiv:1803.00690 [cs, math] (Mar. 2018). arXiv:1803.00690.
- [26] M. C. Achtelik, J. Stumpf, D. Gurdan, K.-M. Doth, Design of a flexible high performance quadcopter platform breaking the mav endurance record with laser power beaming, in: 2011 IEEE/RSJ International Conference on Intelligent Robots and Systems, IEEE, 2011, pp. 5166–5172 (2011).
- [27] B. W. Gu, S. Y. Choi, Y. S. Choi, G. Cai, L. Seneviratne, C. T. Rim, Novel roaming and



stationary tethered aerial robots for continuous mobile missions in nuclear power plants, *Nuclear Engineering and Technology* 48 (4) (2016) 982–996 (2016).

- [28] F. Muttin, Umbilical deployment modeling for tethered UAV detecting oil pollution from ship, *Applied Ocean Research* 33 (4) (2011) 332–343 (2011).
- [29] A. Woodworth, J. Peverill, Tethered Aerial System for Data Gathering, Google Patents, 2013 (2013).
- [30] G. Cai, J. Dias, L. Seneviratne, A Survey of Small-Scale Unmanned Aerial Vehicles: Recent Advances and Future Development Trends, *Unmanned Systems* 02 (02) (2014) 175–199 (Apr. 2014). doi:10.1142/S2301385014300017.
- [31] P. Sujit, S. Saripalli, J. B. Sousa, Unmanned aerial vehicle path following: A survey and analysis of algorithms for fixed-wing unmanned aerial vehicles, *IEEE Control Systems Magazine* 34 (1) (2014) 42–59 (2014).
- [32] F. Kendoul, Survey of advances in guidance, navigation, and control of unmanned rotorcraft systems, *Journal of Field Robotics* 29 (2) (2012) 315–378 (2012).
- [33] H. Shraim, A. Awada, R. Youness, A survey on quadrotors: Configurations, modeling and identification, control, collision avoidance, fault diagnosis and tolerant control, *IEEE Aerospace and Electronic Systems Magazine* 33 (7) (2018) 14–33 (2018).
- [34] M. N. Boukoberine, Z. Zhou, M. Benbouzid, Power supply architectures for drones - a review, in: *IECON 2019-45th Annual Conference of the IEEE Industrial Electronics Society*, IEEE, 2019 (2019).
- [35] B. Glasgow, I. L. Azevedo, C. Hendrickson, How much electricity can we save by using direct current circuits in homes? understanding the potential for electricity savings and assessing feasibility of a transition towards dc powered buildings, *Applied energy* 180 (2016) 66–75 (2016).
- [36] A. Varshney, D. Gupta, B. Dwivedi, Speed response of brushless dc motor using fuzzy pid controller under varying load condition, *Journal of Electrical Systems and Information Technology* 4 (2) (2017) 310–321 (2017).

- [37] S. Norouzi Ghazbi, Y. Aghli, M. Alimohammadi, A. Akbari, Quadrotors unmanned aerial vehicles: A review., *International Journal on Smart Sensing & Intelligent Systems* 9 (1) (2016).
- [38] H. Abaunza, P. C. Garcia, Les applications de drones aériens-L'utilisation civile des UAVs, *Techniques de l'Ingenieur* (2017).
- [39] N. Homainejad, C. Rizos, Application of multiple categories of unmanned aircraft systems (UAS) in different airspaces for bushfire monitoring and response, *International Archives of the Photogrammetry, Remote Sensing & Spatial Information Sciences* 40 (2015).
- [40] E. Turanoğuz, N. Alemdaroğlu, Design of a medium range tactical UAV and improvement of its performance by using winglets, in: *2015 International Conference on Unmanned Aircraft Systems (ICUAS)*, IEEE, 2015, pp. 1074–1083 (2015).
- [41] S. G. Gupta, M. M. Ghonge, P. Jawandhiya, Review of unmanned aircraft system (uas), *International journal of advanced research in computer engineering & technology (IJARCET)* 2 (4) (2013) 1646–1658 (2013).
- [42] T. DRONEII.com, UAV configurations slide – Drone Industry Insights, (Accessed on 14-04-2019) (Jun. 2016).
- [43] R. Ke, Z. Li, S. Kim, J. Ash, Z. Cui, Y. Wang, Real-time bidirectional traffic flow parameter estimation from aerial videos, *IEEE Transactions on Intelligent Transportation Systems* 18 (4) (2017) 890–901 (2017).
- [44] G. Guido, V. Gallelli, D. Rogano, A. Vitale, Evaluating the accuracy of vehicle tracking data obtained from Unmanned Aerial Vehicles, *International Journal of Transportation Science and Technology* 5 (3) (2016) 136–151 (2016).
- [45] J. Leitloff, D. Rosenbaum, F. Kurz, O. Meynberg, P. Reinartz, An operational system for estimating road traffic information from aerial images, *Remote Sensing* 6 (11) (2014) 11315–11341 (2014).
- [46] T. Tang, S. Zhou, Z. Deng, H. Zou, L. Lei, Vehicle detection in aerial images based on region convolutional neural networks and hard negative example mining, *Sensors* 17 (2) (2017) 336 (2017).

- [47] Nokia's UAV Traffic Management Concept Implements LTE Network - Unmanned Aerial, <https://unmanned-aerial.com/nokias-uav-traffic-management-concept-implements-lte-network>, (Accessed on 14-04-2019).
- [48] States Need More Authority to Counter Hostile Drones, <https://www.dailysignal.com/2018/06/13/states-need-more-authority-to-counter-hostile-drones>, (Accessed on 14-04-2019) (Jun. 2018).
- [49] AT&T Working to Make Drone Tower Inspections 'Intelligent', <https://insidetowers.com/cell-tower-news-att-working-make-drone-tower-inspections-intelligent/>, (Accessed on 14-04-2019) (Aug. 2017).
- [50] Z. Zhou, C. Zhang, C. Xu, F. Xiong, Y. Zhang, T. Umer, Energy-efficient industrial internet of uavs for power line inspection in smart grid, *IEEE Transactions on Industrial Informatics* 14 (6) (2018) 2705–2714 (2018).
- [51] J. I. Larrauri, G. Sorrosal, M. González, Automatic system for overhead power line inspection using an Unmanned Aerial Vehicle—RELIFO project, in: *2013 International Conference on Unmanned Aircraft Systems (ICUAS)*, IEEE, 2013, pp. 244–252 (2013).
- [52] F. P. García Márquez, I. Segovia Ramírez, Condition monitoring system for solar power plants with radiometric and thermographic sensors embedded in unmanned aerial vehicles, *Measurement* (2019).
- [53] L. Wang, Z. Zhang, Automatic detection of wind turbine blade surface cracks based on uav-taken images, *IEEE Transactions on Industrial Electronics* 64 (9) (2017) 7293–7303 (2017).
- [54] F. Mohamadi, Vertical Takeoff and Landing (VTOL) Small Unmanned Aerial System for Monitoring Oil and Gas Pipelines, *Google Patents*, 2014 (2014).
- [55] S. Sankarasrinivasan, E. Balasubramanian, K. Karthik, U. Chandrasekar, R. Gupta, Health Monitoring of Civil Structures with Integrated UAV and Image Processing System, *Procedia Computer Science* 54 (2015) 508–515 (2015). doi:10.1016/j.procs.2015.06.058.
- [56] Solar Farm Survey - Thermography Inspection - Falcon.3D, <http://www.falcon3dme.com/drone-solar-wind-farm.html>, (Accessed on 11-04-2019).

- [57] Thermodiagnosis of photovoltaic power plants with infrared camera for UAV, <https://www.drone-thermal-camera.com/drone-uav-thermography-inspection-photovoltaic>, (Accessed on 11-04-2019).
- [58] GE is using drones to inspect the power grid, <http://fortune.com/2015/10/23/ge-drones-power-grid>, (Accessed on 14-04-2019).
- [59] NASA Flies Dragon Eye Unmanned Aircraft, <https://www.nasa.gov/topics/earth/earthmonth/volcanic-plume-uavs.html>, (Accessed on 14-04-2019).
- [60] W. Zang, J. Lin, Y. Wang, H. Tao, Investigating small-scale water pollution with uav remote sensing technology, in: World Automation Congress 2012, IEEE, 2012, pp. 1–4 (2012).
- [61] T. Villa, F. Gonzalez, B. Miljevic, Z. Ristovski, L. Morawska, An overview of small unmanned aerial vehicles for air quality measurements: Present applications and future perspectives, *Sensors* 16 (7) (2016) 1072 (2016).
- [62] F. H. Jufri, V. Widiputra, J. Jung, State-of-the-art review on power grid resilience to extreme weather events: Definitions, frameworks, quantitative assessment methodologies, and enhancement strategies, *Applied Energy* 239 (2019) 1049–1065 (2019).
- [63] Volcano Monitoring Made More Efficient By Drones, <https://www.droneaddicts.net/volcano-monitoring-made-efficient-drones>, (Accessed on 14-04-2019) (Feb. 2018).
- [64] M. Margaritoff, Polish City of Katowice Uses Drone to Combat Smog, <http://www.thedrive.com/aerial/17965/the-polish-city-of-katowice-is-using-a-drone-to-combat-smog>, (Accessed on 14-04-2019).
- [65] H. Matthias, K. Markus, Unmanned aerial vehicles in logistics, <https://www.logistics.dhl/global-en/home/insights-and-innovation/thought-leadership/trend-reports/unmanned-aerial-vehicles.html>, ( Retrieved on 14-04-2019).
- [66] F. Roger, Amazon teases new details of planned Prime Air drone delivery service, <https://appleinsider.com/articles/15/11/30/amazon-teases-new-details-of-planned-prime-air-drone-delivery-service>, (Accessed on 14-04-2019) (Nov. 2015).

- [67] C. T. Howell III, F. Jones, T. Thorson, R. Grube, C. Mellanson, L. Joyce, J. Coggin, J. Kennedy, The First Government Sanctioned Delivery of Medical Supplies by Remotely Controlled Unmanned Aerial System (UAS), <https://ntrs.nasa.gov/archive/nasa/casi.ntrs.nasa.gov/20160009120.pdf>, (Retrieved on 14-04-2019) (2016).
- [68] J. P. Škrinjar, P. Škorput, M. Furdić, Application of unmanned aerial vehicles in logistic processes, in: International Conference “New Technologies, Development and Applications”, Springer, 2018, pp. 359–366 (2018).
- [69] W.-C. Chiang, Y. Li, J. Shang, T. L. Urban, Impact of drone delivery on sustainability and cost: Realizing the uav potential through vehicle routing optimization, *Applied energy* 242 (2019) 1164–1175 (2019).
- [70] Delivery by drone, <http://www.vuedexception.fr/delivery-by-drone>, (Accessed on 14-04-2019) (Jan. 2019).
- [71] O. Garcia, Drones to optimize logistics operations in the country, <http://www.tecnologiard.com/2017/09/drones-para-optimizar-operaciones-logisticas-en-el-pais>, (Accessed on 14-04-2019) (Sep. 2017).
- [72] M. A. Latif, An agricultural perspective on flying sensors: State of the art, challenges, and future directions, *IEEE Geoscience and Remote Sensing Magazine* 6 (4) (2018) 10–22 (2018).
- [73] D. Murugan, A. Garg, D. Singh, Development of an adaptive approach for precision agriculture monitoring with drone and satellite data, *IEEE Journal of Selected Topics in Applied Earth Observations and Remote Sensing* 10 (12) (2017) 5322–5328 (2017).
- [74] G. Potrino, N. Palmieri, V. Antonello, A. Serianni, Drones support in precision agriculture for fighting against parasites, in: 2018 26th Telecommunications Forum (TELFOR), IEEE, 2018, pp. 1–4 (2018).
- [75] Y. Chen, J. P. Guerschman, Z. Cheng, L. Guo, Remote sensing for vegetation monitoring in carbon capture storage regions: A review, *Applied energy* 240 (2019) 312–326 (2019).
- [76] India International Agro Trade and Technology Fair 2019, <https://www.agroworldindia.com>, (Accessed on 15-04-2019).

- [77] UAVs in agriculture, <http://www.vuedexception.fr/drone-en-agriculture-2/>, ( Accessed on 14-04-2019) (Dec. 2018).
- [78] A. Al-Hourani, K. Gomez, Modeling cellular-to-UAV path-loss for suburban environments, *IEEE Wireless Communications Letters* 7 (1) (2018) 82–85 (2018).
- [79] Mathematicians propose to improve cellular network coverage by using UAVs, <https://phys.org/news/2018-09-mathematicians-cellular-network-coverage-uavs.html>, (Accessed on 14-04-2019).
- [80] SkyLiTE: End-to-End Design of Low-Altitude UAV Networks for Providing LTE Connectivity, <https://www.groundai.com/project/skylite-end-to-end-design-of-low-altitude-uav-networks-for-providing-lte-connectivity/>, (Accessed on 14-04-2019).
- [81] D. Jean-Jacques, Bringing cognition to tactical networks, <https://www.mwrf.com/systems/bringing-cognition-tactical-networks>, (Accessed on 14-04-2019).
- [82] RQ-11B Raven Small Unmanned Aircraft Systems (SUAS), <https://www.army.mil/article/137604>, (Accessed on 14-04-2019).
- [83] Maritime applications of unmanned and autonomous vehicles, <https://msconference.wordpress.com/category/maritime-applications-of-unmanned-and-autonomous-vehicles>, (Accessed on 14-04-2019).
- [84] Drone companies showcase 'smart guard' solutions for Indian borders, <https://asia.nikkei.com/Politics/Drone-companies-showcase-smart-guard-solutions-for-India>, (Accessed on 14-04-2019).
- [85] A. F. El-Sayed, Aircraft propulsion and gas turbine engines, CRC press, 2017 (2017).
- [86] R. Austin, Unmanned aircraft systems: UAVS design, development and deployment, Vol. 54, John Wiley & Sons, 2011 (2011).
- [87] B. Lee, P. Park, C. Kim, S. Yang, S. Ahn, Power managements of a hybrid electric propulsion system for UAVs, *Journal of Mechanical Science and Technology* 26 (8) (2012) 2291–2299 (Aug. 2012). doi:10.1007/s12206-012-0601-6.

- [88] O. Z. Sharaf, M. F. Orhan, An overview of fuel cell technology: Fundamentals and applications, *Renewable and Sustainable Energy Reviews* 32 (2014) 810–853 (Apr. 2014). doi:10.1016/j.rser.2014.01.012.
- [89] J. M. Brown, J. A. Coffey, D. Harvey, J. M. Thayer, Characterization and prognosis of multirotor failures, in: *Structural Health Monitoring and Damage Detection, Volume 7*, Springer, 2015, pp. 157–173 (2015).
- [90] E. Bongermينو, M. Tomaselli, V. G. Monopoli, G. Rizzello, F. Cupertino, D. Naso, Hybrid Aeronautical Propulsion: Control and Energy Management, *IFAC-PapersOnLine* 50 (2) (2017) 169–174 (Dec. 2017). doi:10.1016/j.ifacol.2017.12.031.
- [91] N. A. Khofiyah, S. Maret, W. Sutopo, B. D. A. Nugroho, Goldsmith’s commercialization model for feasibility study of technology lithium battery pack drone, in: *2018 5th International Conference on Electric Vehicular Technology (ICEVT)*, IEEE, 2018, pp. 147–151 (2018).
- [92] T. Donateo, A. Ficarella, L. Spedicato, A. Arista, M. Ferraro, A new approach to calculating endurance in electric flight and comparing fuel cells and batteries, *Applied energy* 187 (2017) 807–819 (2017).
- [93] M. Hassanalian, M. Radmanesh, A. Sedaghat, Increasing flight endurance of MAVs using multiple quantum well solar cells, *Int. J. Aeronaut. Space Sci* 15 (2014) 212–217 (2014).
- [94] L. W. Traub, Range and Endurance Estimates for Battery-Powered Aircraft, *Journal of Aircraft* 48 (2) (2011) 703–707 (Mar. 2011). doi:10.2514/1.C031027.
- [95] R. Mike, Whitepaper: Fuel Cell-Based Energy Systems for Commercial UAVs, *Unmanned Systems Technology* (Jul. 2018).
- [96] Neva Aerospace Announces UAV Charging Networks, <https://www.uasvision.com/2017/10/26/neva-aerospace-announces-uav-charging-networks>, ( Accessed on 14-04-2019).
- [97] E. W. Saad, J. L. Vian, M. A. Vavrina, J. A. Nisbett, D. C. Wunsch, Vehicle Base Station, *Google Patents*, 2014 (2014).

- [98] N. K. Gentry, R. Hsieh, L. K. Nguyen, Multi-Use UAV Docking Station Systems and Methods, Google Patents, 2016 (2016).
- [99] J. Leonard, A. Savvaris, A. Tsourdos, Energy management in swarm of unmanned aerial vehicles, *Journal of Intelligent & Robotic Systems* 74 (1-2) (2014) 233–250 (2014).
- [100] P. E. Pounds, Vehicle Replenishment, Google Patents, 2015 (2015).
- [101] 14 uses of drones, <http://internetdiscada.com/14-uses-of-drones-that-sure-did-not-know/>, (Accessed on 14-04-2019) (Sep. 2016).
- [102] F. P. Kemper, K. A. O. Suzuki, J. R. Morrison, UAV Consumable Replenishment: Design Concepts for Automated Service Stations, *Journal of Intelligent & Robotic Systems* 61 (1-4) (2011) 369–397 (Jan. 2011). doi:10.1007/s10846-010-9502-z.
- [103] K. A. O. Suzuki, P. Kemper Filho, J. R. Morrison, Automatic Battery Replacement System for UAVs: Analysis and Design, *Journal of Intelligent & Robotic Systems* 65 (1-4) (2012) 563–586 (Jan. 2012). doi:10.1007/s10846-011-9616-y.
- [104] Z.-n. Liu, Z.-h. Wang, D. Leo, X.-Q. Liu, H.-w. Zhao, QUADO: An autonomous recharge system for quadcopter, in: 2017 IEEE International Conference on Cybernetics and Intelligent Systems (CIS) and IEEE Conference on Robotics, Automation and Mechatronics (RAM), IEEE, Ningbo, 2017, pp. 7–12 (Nov. 2017). doi:10.1109/ICCIS.2017.8274740.
- [105] Zhi-Ning Liu, Xia-Qing Liu, Lu-Jian Yang, D. Leo, H.-W. Zhao, An Autonomous Dock and Battery Swapping System for Multirotor UAV, Unpublished, Retrieved from : <https://www.researchgate.net/publication/325077351> (may 2018). doi:10.13140/RG.2.2.19437.90085.
- [106] N. K. Ure, G. Chowdhary, T. Toksoz, J. P. How, M. A. Vavrina, J. Vian, An Automated Battery Management System to Enable Persistent Missions With Multiple Aerial Vehicles, *IEEE/ASME Transactions on Mechatronics* 20 (1) (2015) 275–286 (Feb. 2015). doi:10.1109/TMECH.2013.2294805.
- [107] K. A. Swieringa, C. B. Hanson, J. R. Richardson, J. D. White, Z. Hasan, E. Qian, A. Girard, Autonomous battery swapping system for small-scale helicopters, in: 2010 IEEE Interna-



- tional Conference on Robotics and Automation, IEEE, Anchorage, AK, 2010, pp. 3335–3340 (May 2010). doi:10.1109/ROBOT.2010.5509165.
- [108] B. Saha, E. Koshimoto, C. C. Quach, E. F. Hogge, T. H. Strom, B. L. Hill, S. L. Vazquez, K. Goebel, Battery health management system for electric UAVs, in: 2011 Aerospace Conference, IEEE, Big Sky, USA, 2011, pp. 1–9 (Mar. 2011). doi:10.1109/AERO.2011.5747587.
- [109] B. Michini, T. Toksoz, J. Redding, M. Michini, J. How, M. Vavrina, J. Vian, Automated Battery Swap and Recharge to Enable Persistent UAV Missions, in: Infotech@Aerospace 2011, American Institute of Aeronautics and Astronautics, St. Louis, Missouri, 2011 (Mar. 2011). doi:10.2514/6.2011-1405.
- [110] M. Lu, M. Bagheri, A. P. James, T. Phung, Wireless charging techniques for uavs: A review, reconceptualization, and extension, IEEE Access 6 (2018) 29865–29884 (2018).
- [111] Fact Sheet – Small Unmanned Aircraft Regulations (Part 107), [https://www.faa.gov/news/fact\\_sheets/news\\_story.cfm?newsId=22615](https://www.faa.gov/news/fact_sheets/news_story.cfm?newsId=22615), (Accessed on 18-07-2019).
- [112] M. Szczys, Laser power system keeps UAVs flying indefinitely, <https://hackaday.com/2012/09/27/laser-power-system-keeps-uavs-flying-indefinitely>, (Accessed on 14-04-2019) (Sep. 2012).
- [113] Powerlight Technologies — Power Over Fiber Case Study — Aerial Applications, <https://powerlighttech.com/power-over-fiber-case-study-aerial-applications>, (Accessed on 14-04-2019).
- [114] Autonomous Surveillance UAV, <http://www.regimage.org/drone-de-surveillance-autonome>, (Accessed on 14-04-2019).
- [115] New Tethered Drone Power Supply System, <http://www.uavexpertnews.com/2017/05/new-tethered-drone-power-supply-system>, (Accessed on 14-04-2019) (May 2017).
- [116] Z. Pan, L. An, C. Wen, Recent advances in fuel cells based propulsion systems for unmanned aerial vehicles, Applied Energy 240 (2019) 473–485 (2019).

- [117] Aerial photography/reconnaissance hexarotor, <http://www.aeroexpo.online/prod/mmc/product-176137-15834.html>, (Accessed on 15-04-2019).
- [118] Q. Cai, D. J. L. Brett, D. Browning, N. P. Brandon, A sizing-design methodology for hybrid fuel cell power systems and its application to an unmanned underwater vehicle, *Journal of Power Sources* 195 (19) (2010) 6559–6569 (2010).
- [119] S. Evangelisti, C. Tagliaferri, D. J. Brett, P. Lettieri, Life cycle assessment of a polymer electrolyte membrane fuel cell system for passenger vehicles, *Journal of cleaner production* 142 (2017) 4339–4355 (2017).
- [120] N. Belmonte, S. Staulo, S. Fiorot, C. Luetto, P. Rizzi, M. Baricco, Fuel cell powered octocopter for inspection of mobile cranes: Design, cost analysis and environmental impacts, *Applied energy* 215 (2018) 556–565 (2018).
- [121] Hydrogen power for aerial autonomy, <https://www.hes.sg/hycopter>, (Accessed on 15-04-2019).
- [122] J.-J. Hwang, J.-K. Kuo, W. Wu, W.-R. Chang, C.-H. Lin, S.-E. Wang, Lifecycle performance assessment of fuel cell/battery electric vehicles, *International Journal of Hydrogen Energy* 38 (8) (2013) 3433 – 3446 (2013). doi:<https://doi.org/10.1016/j.ijhydene.2012.12.148>.
- [123] K. Kim, T. Kim, K. Lee, S. Kwon, Fuel cell system with sodium borohydride as hydrogen source for unmanned aerial vehicles, *Journal of Power Sources* 196 (21) (2011) 9069–9075 (Nov. 2011). doi:[10.1016/j.jpowsour.2011.01.038](https://doi.org/10.1016/j.jpowsour.2011.01.038).
- [124] J. Larminie, A. Dicks, M. S. McDonald, *Fuel Cell Systems Explained*, Vol. 2, J. Wiley Chichester, UK, 2003 (2003).
- [125] Fuel Cell Technologies Office, <https://www.energy.gov/eere/fuelcells/fuel-cell-technologies-office>, (Accessed on 14-04-2019).
- [126] Energyor demonstrates multirotor UAV flight of 3 hours, 43 minutes, <http://energyor.com/news/post:30>, (Accessed on 14-04-2019).

- [127] Horizon Launched World's Longest Endurance Multi-Rotor UAV, <http://robotglobe.org/horizon-launched-worlds-longest-endurance-multi-rotor-uav>, (Accessed on 14-04-2019) (May 2015).
- [128] Project — The Hydrogen Drone, <https://thehydrogendrone.com>, (Accessed on 19-07-2019).
- [129] N. Lapeña-Rey, J. Blanco, E. Ferreyra, J. Lemus, S. Pereira, E. Serrot, A fuel cell powered unmanned aerial vehicle for low altitude surveillance missions, *International Journal of Hydrogen Energy* 42 (10) (2017) 6926–6940 (Mar. 2017). doi:10.1016/j.ijhydene.2017.01.137.
- [130] N. Sulaiman, M. Hannan, A. Mohamed, P. Ker, E. Majlan, W. Wan Daud, Optimization of energy management system for fuel-cell hybrid electric vehicles: Issues and recommendations, *Applied Energy* 228 (2018) 2061–2079 (Oct. 2018). doi:10.1016/j.apenergy.2018.07.087.
- [131] K. Kendall, B. G. Pollet, Hydrogen and Fuel Cells in Transport, *Comprehensive Renewable Energy* 4 (2012) 301 (2012).
- [132] S. S, New fuel drones can fly for hours, <https://techlog360.com/new-fuel-drones-can-fly-for-hours>, (Accessed on 15-04-2019) (aug 2017).
- [133] H. Barthelemy, M. Weber, F. Barbier, Hydrogen storage: Recent improvements and industrial perspectives, *International Journal of Hydrogen Energy* 42 (11) (2017) 7254–7262 (2017).
- [134] How to store hydrogen?, <https://energies.airliquide.com/fr/mediatheque-planete-hydrogene/comment-stocker-lhydrogene>, (Accessed on 14-04-2019) (Apr. 2017).
- [135] Y. Kim, Y. Kim, S. Yeo, K. Kim, K. J.-E. Koh, J.-E. Seo, S. J. Shin, D.-K. Choi, C. W. Yoon, S. W. Nam, Development of a continuous hydrogen generator fueled by ammonia borane for portable fuel cell applications, *Journal of Power Sources* 229 (2013) 170–178 (2013).
- [136] S.-m. Kwon, M. J. Kim, S. Kang, T. Kim, Development of a high-storage-density hydrogen generator using solid-state nabh<sub>4</sub> as a hydrogen source for unmanned aerial vehicles, *Applied Energy* 251 (2019) 113331 (2019).
- [137] J.-E. Seo, Y. Kim, Y. Kim, K. Kim, J. H. Lee, D. H. Lee, Y. Kim, S. J. Shin, D.-M. Kim, S.-Y. Kim, Portable ammonia-borane-based H<sub>2</sub> power-pack for unmanned aerial vehicles, *Journal of Power Sources* 254 (2014) 329–337 (2014).

- [138] K. Swider-Lyons, R. Stroman, G. Page, M. Schuette, J. Mackrell, J. Rodgers, Hydrogen Fuel Cell Propulsion for Long Endurance Small UAVs, in: AIAA Centennial of Naval Aviation Forum” 100 Years of Achievement and Progress”, 2011, p. 6975 (2011).
- [139] R. O. Stroman, M. W. Schuette, K. Swider-Lyons, J. A. Rodgers, D. J. Edwards, Liquid hydrogen fuel system design and demonstration in a small long endurance air vehicle, International Journal of Hydrogen Energy 39 (21) (2014) 11279–11290 (2014).
- [140] J. Gundlach, R. J. Foch, Unmanned Aircraft Systems Innovation at the Naval Research Laboratory (Library of Flight) (2014).
- [141] E. Troncoso, N. Lapeña-Rey, O. Valero, Solar-powered hydrogen refuelling station for unmanned aerial vehicles: Design and initial AC test results, International Journal of Hydrogen Energy 39 (4) (2014) 1841–1855 (2014).
- [142] E. Troncoso, N. Lapena-Rey, O. Valero, Off-grid test results of a solar-powered hydrogen refuelling station for fuel cell powered Unmanned Aerial Vehicles, International Journal of Hydrogen Energy 39 (21) (2014) 11267–11278 (2014).
- [143] E. Troncoso, N. Lapeña-Rey, M. Gonzalez, Design tool for offgrid hydrogen refuelling systems for aerospace applications, Applied Energy 163 (2016) 476–487 (2016).
- [144] N. M. Garceau, S. Y. Kim, C. M. Lim, M. J. Cho, K. Y. Kim, J. H. Baik, Performance test of a 6 L liquid hydrogen fuel tank for unmanned aerial vehicles, in: IOP Conference Series: Materials Science and Engineering, Vol. 101, IOP Publishing, 2015, p. 012130 (2015).
- [145] G. Rhoads, T. Bradley, N. Wagner, B. Taylor, D. Keen, Design and Flight Test Results for a 24 Hour Fuel Cell Unmanned Aerial Vehicle, in: 8th Annual International Energy Conversion Engineering Conference, American Institute of Aeronautics and Astronautics, Nashville, TN, 2010 (Jul. 2010). doi:10.2514/6.2010-6690.
- [146] K. Ou, Y.-X. Wang, Z.-Z. Li, Y.-D. Shen, D.-J. Xuan, Feedforward fuzzy-PID control for air flow regulation of PEM fuel cell system, International Journal of Hydrogen Energy 40 (35) (2015) 11686–11695 (2015).
- [147] K. Ou, W.-W. Yuan, M. Choi, S. Yang, S. Jung, Y.-B. Kim, Optimized power management based on adaptive-PMP algorithm for a stationary PEM fuel cell/battery hybrid system,

- International Journal of Hydrogen Energy 43 (32) (2018) 15433–15444 (Aug. 2018). doi: 10.1016/j.ijhydene.2018.06.072.
- [148] J. J. Cooley, P. Lindahl, C. L. Zimmerman, M. Cornachione, G. Jordan, S. R. Shaw, S. B. Leeb, Multiconverter system design for fuel cell buffering and diagnostics under uav load profiles, *IEEE Transactions on Power Electronics* 29 (6) (2014) 3232–3244 (2014).
- [149] D. Verstraete, J. R. Harvey, J. L. Palmer, Hardware-in-the-loop simulation of fuel-cell-based hybrid-electrical UAV propulsion, in: *Proceedings of the 28th Congress of the International Council of the Aeronautical Sciences*, September, 2012, pp. 23–28 (2012).
- [150] A. Gong, J. L. Palmer, G. Brian, J. R. Harvey, D. Verstraete, Hardware-in-the-loop simulation of a fuel-cell-based UAV propulsion system using real-world flight data, in: *Proceedings of the Fourth Australasian Unmanned Systems Conference*, Australian Association for Unmanned Systems, 2014, p. 7 (2014).
- [151] A. Gong, D. Verstraete, Role of battery in a hybrid electrical fuel cell uav propulsion system, in: *52nd AIAA Aerospace Sciences Meeting*, 2014 (2014).
- [152] A. Gong, J. L. Palmer, G. Brian, J. R. Harvey, D. Verstraete, Performance of a hybrid, fuel-cell-based power system during simulated small unmanned aircraft missions, *International Journal of Hydrogen Energy* 41 (26) (2016) 11418–11426 (Jul. 2016). doi: 10.1016/j.ijhydene.2016.04.044.
- [153] S. Morton, R. D'Sa, N. Papanikolopoulos, Solar powered uav: Design and experiments, in: *2015 IEEE/RSJ International Conference on Intelligent Robots and Systems (IROS)*, IEEE, 2015, pp. 2460–2466 (2015).
- [154] J. R. Harvey, R. A. Jarvis, D. Verstraete, R. L. Bagg, D. Honnery, J. L. Palmer, Development of a hybrid-electric power-system model for a small surveillance aircraft, in: *28th International Congress of the Aeronautical Sciences*, 2012 (2012).
- [155] L. Peng, S. Zheng, X. Chai, L. Li, A novel tangent error maximum power point tracking algorithm for photovoltaic system under fast multi-changing solar irradiances, *Applied energy* 210 (2018) 303–316 (2018).

- [156] A. Zhang, An overview of the global solar-powered UAV market 2017-2021, <https://www.wetalkuav.com/global-solar-powered-uav-market>, (Accessed on 14-04-2019) (Jan. 2018).
- [157] M. Conner, Helios Prototype Flying Wing, <http://www.nasa.gov/centers/dryden/multimedia/imagegallery/Helios/ED01-0209-3.html>, (Accessed on 13-04-2019) (Jun. 2015).
- [158] M. Aneke, M. Wang, Energy storage technologies and real life applications—a state of the art review, *Applied Energy* 179 (2016) 350–377 (2016).
- [159] J. Ruan, P. D. Walker, N. Zhang, J. Wu, An investigation of hybrid energy storage system in multi-speed electric vehicle, *Energy* 140 (2017) 291–306 (2017).
- [160] H. Wang, Q. Wang, B. Hu, A review of developments in energy storage systems for hybrid excavators, *Automation in Construction* 80 (2017) 1–10 (2017).
- [161] H. Li, A. Ravey, A. N'Diaye, A. Djerdir, A novel equivalent consumption minimization strategy for hybrid electric vehicle powered by fuel cell, battery and supercapacitor, *Journal of Power Sources* 395 (2018) 262–270 (2018).
- [162] A. Gong, J. L. Palmer, D. Verstraete, Flight test of a fuel-cell/battery/supercapacitor triple hybrid uav propulsion system, in: 31st Congress of the International Council of the Aeronautical Sciences (ICAS 2018), p. 11.
- [163] L. Karunarathne, J. T. Economou, K. Knowles, Model based power and energy management system for pem fuel cell/li-ion battery driven propulsion system, in: 5th IET International Conference on Power Electronics, Machines and Drives (PEMD 2010), IET, 2010 (2010).
- [164] X. Zhang, L. Liu, Y. Dai, T. Lu, Experimental investigation on the online fuzzy energy management of hybrid fuel cell/battery power system for UAVs, *International Journal of Hydrogen Energy* 43 (21) (2018) 10094–10103 (May 2018). doi:10.1016/j.ijhydene.2018.04.075.
- [165] L. Karunarathne, J. T. Economou, K. Knowles, Adaptive neuro fuzzy inference system-based intelligent power management strategies for fuel cell/battery driven unmanned electric aerial vehicle, *Proceedings of the Institution of Mechanical Engineers, Part G: Journal of Aerospace Engineering* 224 (1) (2010) 77–88 (Jan. 2010). doi:10.1243/09544100JAER0514.

- [166] Z. Yang, T. Lei, Z. Lin, H. Fu, X. Zhang, The Testing Platform of Hybrid Electric Power System for a Fuel Cell Unmanned Aerial Vehicle, in: 2018 IEEE International Conference on Electrical Systems for Aircraft, Railway, Ship Propulsion and Road Vehicles & International Transportation Electrification Conference (ESARS-ITEC), IEEE, Nottingham, 2018, pp. 1–8 (Nov. 2018). doi:10.1109/ESARS-ITEC.2018.8607778.
- [167] B. Lee, S. Kwon, P. Park, K. Kim, Active power management system for an unmanned aerial vehicle powered by solar cells, a fuel cell, and batteries, IEEE Transactions on Aerospace and Electronic Systems 50 (4) (2014) 3167–3177 (Oct. 2014). doi:10.1109/TAES.2014.130468.
- [168] B. G. Gang, S. Kwon, Design of an energy management technique for high endurance unmanned aerial vehicles powered by fuel and solar cell systems, International Journal of Hydrogen Energy 43 (20) (2018) 9787–9796 (May 2018). doi:10.1016/j.ijhydene.2018.04.049.
- [169] X. Zhang, L. Liu, Y. Dai, Fuzzy State Machine Energy Management Strategy for Hybrid Electric UAVs with PV/Fuel Cell/Battery Power System, International Journal of Aerospace Engineering 2018 (2018) 1–16 (Jul. 2018). doi:10.1155/2018/2852941.
- [170] X.-Z. Gao, Z.-X. Hou, Z. Guo, J.-X. Liu, X.-Q. Chen, Energy management strategy for solar-powered high-altitude long-endurance aircraft, Energy Conversion and Management 70 (2013) 20–30 (Jun. 2013). doi:10.1016/j.enconman.2013.01.007.
- [171] Jinming Liu, Huei Peng, Modeling and Control of a Power-Split Hybrid Vehicle, IEEE Transactions on Control Systems Technology 16 (6) (2008) 1242–1251 (Nov. 2008). doi:10.1109/TCST.2008.919447.
- [172] M. Zandi, A. Payman, J.-P. Martin, S. Pierfederici, B. Davat, F. Meibody-Tabar, Energy Management of a Fuel Cell/Supercapacitor/Battery Power Source for Electric Vehicular Applications, IEEE Transactions on Vehicular Technology 60 (2) (2011) 433–443 (Feb. 2011). doi:10.1109/TVT.2010.2091433.
- [173] A. Savvaris, Y. Xie, K. Malandrakis, M. Lopez, A. Tsourdos, Development of a fuel cell hybrid-powered unmanned aerial vehicle, in: 2016 24th Mediterranean Conference on Control and Automation (MED), IEEE, Athens, Greece, 2016, pp. 1242–1247 (Jun. 2016). doi:10.1109/MED.2016.7536038.

- [174] T. Bradley, B. Moffitt, D. Parekh, T. Fuller, D. Mavris, Energy Management for Fuel Cell Powered Hybrid-Electric Aircraft, in: 7th International Energy Conversion Engineering Conference, American Institute of Aeronautics and Astronautics, Denver, Colorado, 2009 (Aug. 2009). doi:10.2514/6.2009-4590.
- [175] H. V. Abeywickrama, B. A. Jayawickrama, Y. He, E. Dutkiewicz, Comprehensive energy consumption model for unmanned aerial vehicles, based on empirical studies of battery performance, *IEEE Access* 6 (2018) 58383–58394 (2018).
- [176] A. S. Prasetya, R.-J. Wai, Y.-L. Wen, Y.-K. Wang, Mission-based energy consumption prediction of multirotor uav, *IEEE Access* 7 (2019) 33055–33063 (2019).