



HAL
open science

Assessment of a flexible solar hybrid thermal and electrical prototype

Brice Lecœuvre, Ghjuvan Antone Faggianelli, Jean-Louis Canaletti, Christian Cristofari

► **To cite this version:**

Brice Lecœuvre, Ghjuvan Antone Faggianelli, Jean-Louis Canaletti, Christian Cristofari. Assessment of a flexible solar hybrid thermal and electrical prototype. *Renewable Energy*, 2020, 146, pp.1354 - 1363. <10.1016/j.renene.2019.06.151>. <hal-03487363>

HAL Id: hal-03487363

<https://hal.science/hal-03487363v1>

Submitted on 20 Dec 2021

HAL is a multi-disciplinary open access archive for the deposit and dissemination of scientific research documents, whether they are published or not. The documents may come from teaching and research institutions in France or abroad, or from public or private research centers.

L'archive ouverte pluridisciplinaire **HAL**, est destinée au dépôt et à la diffusion de documents scientifiques de niveau recherche, publiés ou non, émanant des établissements d'enseignement et de recherche français ou étrangers, des laboratoires publics ou privés.



Distributed under a Creative Commons CC BY-NC 4.0 - Attribution - Non-commercial use - International License

30 increase have brought new challenges in terms of energy storage and control.
31 In this context, the development of microgrids including Distributed Energy
32 Resources (DER) appear to be a promising solution to build a more reli-
33 able grid while increasing the share of RES. The key technologies required
34 to achieve successful deployment of microgrids include advanced components
35 as well as advanced control strategies. As a locally controlled system, a mi-
36 crogrid should be able to ensure continuous supply of electrical and possibly
37 thermal loads. It is thus especially important to develop easily controlled
38 Distributed Generation (DG) which bring more flexibility and reliability.

39 Combined Heat and Power (CHP) is a mature and well-known process al-
40 lowing simultaneous generation of electricity and useful heating. Advantages
41 and disadvantages of CHP systems have been widely described in literature
42 [1]. It should be noted that heat is generally lower-quality energy than elec-
43 tricity and both heating and electricity demand must remain fairly consistent.
44 Also, CHP systems do not allow modulation of one source with respect to
45 the other. They are thus not suitable for all sites and must be seen more as
46 a mean of extending energy rather than two actual energy sources.

47 An other way to produce both electricity and useful heating is to use
48 PhotoVoltaic-Thermal (PVT) solar systems [2]. A significant amount of work
49 has been carried out on these systems since 1970 and most recent ones such as
50 the Hybrid Electric And Thermal Solar (HEATS) aim to reach an efficiency
51 greater than 35% [3]. Performances can also be increased with the use of
52 Concentrated PhotoVoltaic Thermal (CPVT) [4]. The main advantage of this
53 technology lies in the possibility to reach higher temperature while increasing
54 efficiency of the photovoltaic side [5]. However, as for standard CHP systems,
55 the production of useful heating is still directly related to the electricity one,
56 which may be a concern according to the needs.

57 Other than these types of technologies, real hybrid systems with fully
58 adjustable production of electrical and thermal energy are not described in
59 literature. For specific case studies, highly variable needs of heat and elec-
60 tricity can be observed over the time. Energy storage is one of the key to
61 overcome this issue but is no more suitable if there is no need of one energy
62 source over a long period.

63 In the framework of the research project PAGLIA ORBA, the laboratory
64 SPE (University of Corsica, France) aims to test and characterise components
65 of a solar microgrid at the scale of a village or a neighborhood. This paper
66 focuses on a prototype of an easily controlled DG system which can produce
67 both electrical and thermal energy simultaneously or individually. The last

68 prototype of the so-called SRLO system is a concentrating hybrid solar power
69 system composed of several reversible and controllable blades:

- 70 • One side of each blade is a mirror which concentrates solar radiation
71 on a fixed receiver.
- 72 • The other side integrates photovoltaic modules.

73 Since the first publication produced in 1980 by Peri [6], this system has
74 known a number of evolutions.

75 1.1. First prototype

76 At the time, the invention of the first prototype, called *linear concen-*
77 *tration solar collector*, responds to a specific demand: to produce thermal
78 energy at medium temperature. This solar concentrating system, presented
79 in figure 1, belongs to the category of Linear Fresnel Reflective (LFR). Most
80 LFR are positioned facing the sky [7] [8]. Indeed, the structure supporting
81 the mirrors is parallel to the ground and the axis of rotation of the mirrors is
82 north-south, in order to keep track of the azimuth. This prototype does not
83 exactly follow this pattern: its structure is tilted at 60° to the south, and the
84 axis of the mirrors is east/west. This type of system is more adapted to the
85 location studied with a latitude of 42.30° .

86 The first problem that arises for the conversion of solar radiation is the
87 choice of the thermal converter. Several solutions are depending on the type
88 of use, from simple fixed plane collector, with a simple greenhouse effect, to
89 parabolic system equipped with a structure to follow the sun. The choice of
90 collector depends on the desired temperature level. The operating tempera-
91 ture of the prototype was $140^\circ C$. To meet this requirement in steady state,
92 fixed plan collector even equipped with elaborate anti-loss devices can no
93 longer compete with solar concentrating systems. Conversely, high flow rate
94 collectors lose their interest when the level of requested temperature is low;
95 these facilities are too complex and expensive to use at low temperatures.
96 At the time, vacuum collectors were not a option as their commercialisation
97 was only beginning to emerge [9] [10].

98 Unlike conventional parabolic and cylindro-parabolic systems, the re-
99 ceiver and the reflective structure are completely independent from a me-
100 chanical point of view. The receiver is very elongated, facing north, and
101 placed so that its main axis is oriented east/west. The entire receiver is
102 placed at a certain height to optimise the received radiation. The reflective

103 structure supports a number of plane mirrors, mobile around the east/west
104 axis.

105 Several works have been done by Pasquetti, allowing the validation of a
106 first numerical model, realised with punch cards [11] [12]. A numerical model
107 study has been carried out to give a first insight of the production of such
108 device. This study was made for a latitude for 43.30° corresponding to the
109 location of Marseille (France) with an operating temperature of $140^\circ C$. A
110 mean efficiency $\eta_{receiver}$ of 0.59 has been obtained.

111 Even if the production of thermal energy remains "moderate" (low tem-
112 perature) compared to a parabolic system (high temperature), this prototype
113 has many advantages:

- 114 • easy implementation, through the simplicity of the system;
- 115 • easy maintenance, through this same simplicity;
- 116 • low cost price, through the use of a structure of rustic concentration
117 and simplified tracking (single axis);
- 118 • interesting temperature level for number of applications (between $120^\circ C$
119 and $160^\circ C$);
- 120 • fixed receiver near the ground level and therefore easily accessible;
- 121 • good protection of the mirrors against dirt, through the possibility of
122 orienting them towards the ground in periods of non-use and towards
123 the sky during periods of rain;
- 124 • very high wind resistance of the reflective structure;
- 125 • functional safety facilitated by the possibility of defocusing the mirrors.

126 *1.2. Second prototype*

127 In the years 1985, a second prototype is conceived on the site of University
128 of Corsica (Ajaccio, France) thanks to Pr. Georges Peri. It is also composed
129 of a longitudinal structure oriented east/west. This supports the moving
130 axes of four units of sixteen aluminium blades and composed of a reflective
131 surface. The axes of each line are coupled at the end of the structure by
132 pulleys interconnected by a steel cable.

133 This system makes it possible, with a simple movement, to obtain an
134 equal angular variation for all the mirrors and to transform it into a linear
135 variation. This second version is also a system that is positioned manually,
136 with a handle that allows linear movement of the cable. In addition, the
137 dimensions of the structure have been changed. The structure is inclined
138 at 60° to the horizontal, with a height of 2 m and a length of 10 m. it is
139 composed of sixteen blades measuring $10\text{ cm} \times 24\text{ cm}$.

140 1.3. Third prototype

141 In 1990, a third prototype is realised. The main innovation is the automa-
142 tion of the blades positioning, so that the focus of solar radiation is ensured
143 throughout the year. To do this, the design of a servo of the blades position
144 is essential. In the study done by Canaletti [13], two types of techniques are
145 used. A first, based on optoelectronic technique with cells sensitive to solar
146 radiation and an electronic control. A second, using computer which, with
147 the help of data on the trajectory of the sun, corrects the angular position
148 of the mirrors. Finally, a control-command acts on the hydraulic actuator
149 which allows placing all the mirrors at the same time to insure the focusing
150 of solar radiation on the receiver.

151 Now, the system moves these blades automatically. However, it still has
152 drawbacks :

- 153 • several elements require a source of electrical power to function as the
154 pump, the three-way valves, the hydraulic actuator and the control-
155 command;
- 156 • the enslavement of mirrors works in *on/off* mode.
- 157 • the pump has a constant flow.

158 When the set-point temperature is exceeded, the action of the hydraulic
159 actuator defocuses all the mirrors. The hysteresis comparator is difficult to
160 set. In fact, all the mirrors move at the same time and cause large variations
161 of power.

162 This paper thus focuses on the description of a new prototype, which
163 main purpose is to mitigate these drawbacks. First, we provide a general
164 description of the system, to highlight the main evolutions. Then we focus
165 on the solar and geometric parameters required to control the system. To

166 conclude, main results are discussed and some recommendations and outlooks
167 are proposed.

168 **2. New prototype**

169 *2.1. General description*

170 Previously, this system could only produce thermal energy. The new
171 prototype can still produce thermal energy (figure 2), with the concentration
172 of solar radiation, but can also produce electrical energy (figure 3) through
173 the modules positioned on the back. Such system can now also be seen as a
174 DG of a microgrid.

175 It has 64 blades with a length of 2.42 m and a width of 10 cm. Blades
176 are composed of a reflective surface on one side and on the other side of a
177 surface integrating photovoltaic modules. Four polycrystalline modules are
178 installed per blade, with a length of 600 mm and a width of 100 mm. The
179 real dimensions of the module surface are 538 mm \times 77 mm, with a peak
180 power of 5 W per module. The total area of the module is 10.7 m^2 , resulting
181 in a total peak power of 1280 W.

182 For the solar radiation concentration part, the blades are covered by mir-
183 rors made of aluminium foil, which is placed under a glass pane to ensure
184 its protection. The aim is to produce thermal energy at a constant temper-
185 ature as often as possible. The enslavement of each blade is now performed
186 independently. To do this, gear motors are placed at the end of each blade.
187 Independent control of mirrors can modulate the concentration and thus en-
188 slaves the temperature level. If a mirror is defocused, it can be directed to
189 incident radiation to produce electrical energy. This energy is then stored in
190 batteries.

191 This prototype can therefore operate in three different modes:

- 192 • thermal mode,
- 193 • electrical mode,
- 194 • thermal/electrical mode.

195 The electrical mode ensures the operation of the system and can also
196 supply power to an external load.

197 The hydraulic loop has been also improved. It is first equipped with
198 six three-way valves to use the four receivers in five different modes. The

199 configuration of the receivers may be in serial mode, in parallel mode or
200 in intermediate modes. To improve the temperature level, the conventional
201 pump has been replaced by two solar pumps with variable flow. They operate
202 in DC current and have a Maximum Power Point Tracking (MPPT). The
203 control-command can now operate in real time. It adapts the operation of
204 the primary loop according to the incident radiation and the set temperature.
205 Previously, the conventional greenhouse emitter was not suitable for this type
206 of system because the glass heated quickly when all the mirrors were focused
207 on the solar radiation. With all these improvements, three types of servo are
208 possible:

- 209 • modulation of the concentration by servocontrolling each mirror line;
- 210 • modulation of the flow rate by servocontrol of the variable flow solar
211 pumps; modulation of the concentration coupled with the modulation
212 of the flow rate.
- 213 • modulation of receiver configuration.

214 The system, shown in the figure 4, is now able to produce thermal en-
215 ergy respecting a set temperature, but also to produce electrical energy for
216 its autonomy and external load. The nominal and maximum power of the
217 control is respectively 87 and 165 W. We consider that during a day, the
218 system operates with maximum consumption for a duration of 4 hours and
219 the remaining time at its nominal consumption. This results in a daily con-
220 sumption of 2.4 kWh.

221 2.2. Receivers

222 The solar radiation reflected by the mirrors is focused on four linear re-
223 ceivers. They are equipped with black absorbers to limit the reflection of
224 solar radiation increasing its efficiency. The absorbers are made of two alu-
225 minium plates. Between these two plates, a copper tube with an external
226 diameter of 10 mm is positioned. All these elements are welded together by
227 ultrasound to ensure high thermal contact. The absorber is positioned on
228 the front of each receiver. An insulation of 5 cm surrounds the absorber.
229 Here are the values characterising the receiver:

- 230 • the dimensions of each receiver are $L_{receiver} = 205\text{ cm}$ and $l_{receiver} =$
231 25 cm ;

- 232 • the aluminum casing has an absorption value of $\alpha_{alu} = 0.90$;
- 233 • the dimensions of the glass of the absorber are $L_{glass} = 195\text{ cm}$ and
234 $l_{glass} = 15\text{ cm}$;
- 235 • the glass has an absorption value of $\alpha_{glass} = 0.055$ and a transmittance
236 value of $\tau_{glass} = 0.866$;
- 237 • the dimensions of each absorber are $L_{abs} = 195\text{ cm}$ and $l_{abs} = 15\text{ cm}$;
- 238 • the total area of absorbers is $S_{abs} = 1.17\text{ cm}^2$
- 239 • the absorber has an absorption value of $\alpha_{abs} = 0.95$;
- 240 • this results in a geometric concentration corresponding to 13.2, by es-
241 tablishing the ratio between the total surface of the mirrors and the
242 total surface of the absorbers;
- 243 • the height of the receiver (between the ground and the middle of the
244 absorber) is 74 cm.
- 245 • the distance between the reflective surface and the receiver is 1 m.
246 This distance can be changed, but then the precision of the motor that
247 focuses the solar radiation will have to be changed as well. Currently
248 the rotation of 1 degree of the farthest mirror causes a *spot* shift on the
249 receiver of more than 10 cm.

250 A three-dimensional model of one of the receivers is shown in figure 5.

251 2.3. Hydraulic circuit

252 The hydraulic circuit (figure 6) allows the circulation of the heat transfer
253 fluid. It consists mainly of copper tubes with a diameter of 12 mm. The
254 thermal insulation of these tubes is ensured by a heat-insulated sheath of
255 10 mm thickness, made of synthetic rubber-based foam (elastomer). This
256 hydraulic circuit consists of:

- 257 • a black tank called the discharge tank, made of steel (2 mm thick),
258 with a storage capacity of 300 liters; it simulates a thermal load;
- 259 • an insulated Domestic Hot Water (DHW) tank of 300 liters, for storing
260 water at a temperature from 60°C to 70°C ;

- 261 • seven three-way solenoid valves, which make it possible to shunt the
262 DHW and allow different configurations of the receivers (figure 7);
- 263 • two variable speed pumps for modulating the flow of the fluid.

264 In fact, the purpose of the system is to respond to a thermal load; if the
265 supply of this load is guaranteed, then it can store the thermal energy in the
266 DHW tank.

267 3. Solar and geometric parameters of the system

268 3.1. Angular height of the sun in the north/south plane

269 To know the angular elevation of the sun seen from this plane, it is nec-
270 essary to realise its orthogonal projection. Let h_p be the projection of the
271 angular height of the sun in the plane of the structure that we call projected
272 angular height:

$$\tan(h_p) = \frac{\tan(h)}{\cos(\Psi - \gamma)} \quad (1)$$

273 Due to boundary conditions ($\Psi = 90^\circ$) the equation is:

$$\tan\left(\frac{\pi}{2} - h_p\right) = \frac{\cos(\Psi - \gamma)}{\tan(h)} \quad (2)$$

274 3.2. Solar deviation

275 To find the solar deviation from the plane, as shown in figure 8, it is
276 necessary to calculate the projected solar deviation angle Ψ_p formed by the
277 incident radiation and its projection in the plane. We get the relation:

$$\cos(\Psi_p) = \cos(h) \sin(\Psi - \gamma) \quad (3)$$

278 3.3. Angle of inclination of mirrors

279 The enslavement of the positioning of the mirrors to ensure a focus of
280 the solar radiation is based on the calculation of the angles of inclination of
281 the mirrors. The parameters used to obtain these values are the date, the
282 time and the coordinates of the place. The use of these parameters requires
283 knowledge of the geometry of the system:

284 • D_N : the projected distance on the horizontal plane between each

$$D_N = D + \cos(\beta) N X \quad (4)$$

285 • H_{2N} : the height of each mirror N , whose expression is:

$$H_{2N} = \sin(\beta) N X \quad (5)$$

286 That is, h_{m_N} the difference in angular height between each mirror N and
287 the receivers:

$$h_{m_N} = \arctan\left(\frac{H_1 - H_{2N}}{D_N}\right) \quad (6)$$

288 If h_p is the projected angular elevation of the sun and h_{m_N} the difference
289 in angular height of each mirror N , then, by Descartes' relation, we obtain,
290 for each mirror, the angle of incidence projected on the horizontal plane
291 including the normal to the mirror, Θ_{pN} :

$$\Theta_{pN} = \frac{h_p - h_{m_N}}{2} \quad (7)$$

292 So the inclination β_{1N} of each mirror N with respect to the vertical is
293 expressed:

$$\begin{aligned} \beta_{1N} &= \Theta_{pN} + h_{m_N} \\ \beta_{1N} &= \frac{h_p + h_{m_N}}{2} \end{aligned} \quad (8)$$

294 The use of these angles of inclination for each mirror allows the focusing
295 of solar radiation on the receivers.

296 3.4. Width of the spot on the receiver

297 The width of the *spot* varies only according to the angles of inclination
298 of the mirror and the receiver:

$$l_{a_N} = l_{mirror} \frac{\cos(\beta_{1N} - h_p)}{\cos(\beta_2 - h_p)} \quad (9)$$

299 *3.5. Angle of movement*

300 The angle called *angle of movement* represents the angle swept by a re-
 301 flected ray to traverse the remaining distance between the edge of the *spot*
 302 and the edge of the receiver. The calculation of this parameter makes it pos-
 303 sible to optimise the consumption of the system. In fact, we will know the
 304 actual time before which the *spot* must leave the receiver and therefore the
 305 time interval between two readjustments. The parameters (figure 9) useful
 306 for obtaining this time interval are described in the appendix.

307 *3.6. Exit time from the edge of the spot*

308 The angle swept through a reflected ray to traverse the receiver is now
 309 known. It is now necessary to calculate the exit time of the *spot*.

- 310 • h_p and ω : respectively the projected angular height of the sun and the
 311 hour angle at time t_1
- 312 • ω_{S_N} : the new hour angle, for h_p corrected by hc_{1_N} or hc_{2_N} depending
 313 on the case, knowing that:

$$\cos(\Psi) = \frac{\sin(h) \sin(\phi) - \sin(\delta)}{\cos(h) \cos(\phi)} \quad (10)$$

$$\tan(h_p) = \frac{\tan(h)}{\cos(\Psi - \gamma)} \quad (11)$$

314 We get h based on h_p :

$$\begin{aligned} \sin(h) &= \frac{\sin(\delta) \tan(h_p)}{\sin(\phi) \tan(h_p) - \cos(\phi)} \\ &= \frac{\sin(\delta)}{\sin(\phi) - \cos(\phi) \tan\left(\frac{\pi}{2} - h_p\right)} \end{aligned} \quad (12)$$

315 Knowing also that:

$$\begin{aligned} \sin(h) &= \cos(\delta) \cos(\phi) \cos(\omega) \\ &\quad + \sin(\delta) \sin(\phi) \end{aligned} \quad (13)$$

316

We get ω depending h :

$$\cos(\omega) = \frac{\sin(h) - \sin(\delta) \sin(\phi)}{\cos(\delta) \cos(\phi)} \quad (14)$$

317

Depending on the time of year, this time interval is obtained differently:

318

- First case: between the equinox of spring and autumn, h_p increases in the afternoon, so we correct h_p by adding hc_{1N} . We calculate the corresponding hour angle ω_{S_N} , then we deduce the corresponding time T :

319

320

321

$$T_{N_s} = \frac{|\omega - \omega_{S_N}|}{0.2618} \quad (15)$$

322

- Second case: between the equinox of autumn and spring, h_p decreases in the afternoon, so we correct h_p by subtracting hc_{1N} . We calculate the corresponding hour angle ω_{S_N} , then we deduce the corresponding time T , as in the first case.

323

324

325

326

- Third case : to obtain the exit time of the *spot* in the morning between the equinox of spring and autumn, it is necessary to calculate the angle of the mirrors at solar noon, because at this moment their movement is reversed:

327

328

329

330

- if h_p corrected by hc_{2N} is smaller than the angle at solar noon, we calculate as before ω_{S_N} et T_N ;

331

332

- if h_p corrected by hc_{2N} is larger than the solar angle at noon, the time elapsed until solar noon is calculated:

333

$$T_{1N} = \frac{|\omega|}{0.2618} \quad (16)$$

334

Then we calculate ω_{S_N} corresponding to h_p corrected, this time, by hc_{1N} (since the movement is reversed) and of the angle travelled until noon solar. We therefore deduce the time T_{2N} :

335

336

$$T_{2N} = \frac{|\omega_{S_N}|}{0.2618} \quad (17)$$

337 The exit time is:

$$T_N = T_{1_N} + T_{2_N} \quad (18)$$

338 • Fourth case: to obtain the exit time of the *spot* in the morning between
339 the equinox of autumn and spring, we apply the same reasoning as in
340 the third case.

341 All these equations are essential for the control-command.

342 4. Receiver height optimisation

343 The optimisation of the height of the receivers is an essential step (figure
344 10) to obtain maximum energy. To do this, an energy study to know the
345 power arriving at the receivers, integrated throughout the year, has been
346 conducted. This work has three stages. Beforehand, a first step is to calcu-
347 late the energy received by the absorber of the receiver without taking into
348 account the solar deviation. A second step is performed, with the same cal-
349 culation, but considering also the solar deviation. Finally, the shading effect
350 of by the receivers on the reflective structure is considered. This makes it
351 possible to quantify the real energy arriving on the absorber. This approach
352 allows the calculation of the energy lost by the deviation and the impact of
353 the shadow caused by the receivers.

354 4.1. Assumption

355 The optimum height of the receiver is obtained when the angle of inci-
356 dence is the lowest for all the mirrors, for all the days of the year. The first
357 set of assumptions are:

- 358 • no energy losses due to solar deviation;
- 359 • purely geometrical consideration;
- 360 • use of the theoretical value of extraterrestrial radiation (we do not
361 consider losses due to cloudiness, rain, pollution, etc.);
- 362 • all the energy received by the mirrors is concentrated on the absorbers
363 of the receivers.

364 The calculation is the sum of the resulting powers of the sixteen mirrors
 365 integrated throughout the year. We know that :

- 366 • the power at a given moment for each mirror N , corresponds to the
 367 equation:

$$P_{1N} = S_{mirror} I_0 \cos(\Theta_{p_n}) \quad (19)$$

368 with S_{mir} corresponding to the surface of a line of mirrors and $I_0 =$
 369 1367 W.

- 370 • to obtain the annual energy, one needs to integrate the power on each
 371 day of the year; we choose the minute as time step.

372 Then, with the same assumptions as before, we integrate the energy loss
 373 due to solar deviation. We must therefore calculate the new lengths of each
 374 mirror N :

$$L_{1N} = D_N \tan(\Psi - \gamma) \quad (20)$$

375 L_{1N} is then evaluated to know the real energy that arrives on the absorbers
 376 of the receivers. In fact, the system is equipped with four concentration mod-
 377 ules that are assembled together; the system therefore has spaces between
 378 the modules. These spaces are taken into consideration as well as the exact
 379 position of the focus of each mirror.

380 Finally, we quantify the energy loss due to the shadowing effect of the
 381 receiver, on the structure.

382 For each geometric parameter of the system, several calculations are es-
 383 tablished and the choice of equations will vary according to the time, day
 384 and season. A condition set will select the proper equation depending on the
 385 position of the sun and that for each parameter.

386 4.2. Results and discussions

387 The figure 11 shows that the energy received, without taking into ac-
 388 count the solar deviation, is important (46.4 MWh.yr^{-1}). The effect of solar
 389 deviation induces an energy loss of 20.9 %. The energy received is then
 390 36.7 MWh.yr^{-1} . The third assumptions induces an energy loss of 29.4 %
 391 compared to the first, with an energy production of 34.6 MWh.yr^{-1} . The

392 optimal heights of the solar receiver for the three studies, are respectively
393 234 cm, 168 cm and 143 cm (figure 12).

394 In all three cases (figure 13), the largest energy production is obtained
395 around the equinoxes. The height of the receiver has a lot of influence on the
396 difference in production in winter and summer. Indeed, if we decrease this
397 height, the production will be higher in winter and lower in summer.

398 In order to obtain an annual energy maximum, a receiver height between
399 70 cm and 150 cm with a receiver-structure distance of 1 m is possible. In
400 this range, the energy loss against the optimal value is less than 1%.

401 We recommend to minimize the receiver height (74 cm for our prototype),
402 as this bring a lower cost of materials (shorter length), a less complicated
403 installation to realise and a less difficult maintenance to perform.

404 Finally, the energy from the reflective surface is much higher than the
405 energy received by the absorbers. The losses are mainly due to the solar
406 deviation and the spacing between the absorbers. To recover this lost energy,
407 it would be first necessary to remove the space between the absorbers and
408 then to reduce the azimuth effect. For this, three ways to proceed. A first
409 is to increase the length of the mirrors knowing that the energy from the
410 reflective surface will be further increased relative to the energy received
411 by the absorbers (higher geometric concentration). Reflectors could also be
412 positioned to recover lost energy. A last method would be to make the
413 absorbers mobile and position them according to the solar deviation. The
414 latter is not very realistic even if it is technically possible.

415 5. Concentration rate

416 When considering solar concentration, we often refer to the geometric
417 concentration factor. Indeed, this factor is still applicable for concentrating
418 systems that follow the sun on two axes. For concentrating systems that
419 follow the sun on a single axis, such as the one studied in this paper, this
420 concentration factor is not the same:

$$\eta_{SRLO} = \frac{S_{mir_{tot}}}{S_{abs_{tot}}} \quad (21)$$

421 This factor is maximum at solar-noon for a south-facing system. In order
422 to know the actual concentration rate, the parameter S must represent the
423 surface of the *spot* reflected by the mirrors of the system that arrives on the
424 absorber.

425 The figure 14 illustrates the actual concentration rate during a day of
426 equinox, summer solstice and winter solstice. As we have chosen a low height
427 of receiver, 74 *cm*, the concentration rate is higher during winter.

428 The figure 15 shows this same concentration rate as a function of azimuth
429 angle. For a single axis system, the concentration rate only exists when the
430 sun is in front of the system. As the SRLO is not perfectly south-facing, the
431 corresponding azimuth angles at the equinox are not exactly $\pm 90^\circ$.

432 It can be seen in figures 14 and 15 that the actual concentration rate is
433 always lower than the geometric concentration factor of 13.2. This shows
434 that this factor should not be considered for a single axis system as it tends
435 to overestimate the solar radiation received by the mirrors. If the length of
436 the reflective surface was identical to the length of the absorbers, this factor
437 should be reached at solar-noon for a south-facing system. For the SRLO,
438 this factor is never reached as the length of the reflective surface is actually
439 greater than the length of the absorbers.

440 These figures also show that the geometry of SRLO is optimised for win-
441 ter. For the same period, it can be seen that the shadow of the receiver has
442 important influence on the concentration rate. The longest period to pro-
443 duce thermal energy is during the equinox. The actual concentration rate
444 will allow us to improve the operating profiles.

445 6. Conclusion

446 SRLO is a hybrid system that can produce both thermal energy and
447 electrical energy. It consists in a fixed structure supporting sixteen movable
448 blades, which can either concentrate solar radiation on a fixed receiver with
449 mirrors or produce electricity with photovoltaic modules.

450 The system described in this paper is the outcome of several prototypes
451 improved over time. In this last version, PV modules have been added to
452 cover self-supply of the system and potential external loads, with the pos-
453 sibility of storing electricity in batteries. Also, all blades can now move
454 independently, thanks to geared motors. It is then possible to defocus each
455 mirror individually, in order to modulate the concentration and thus to en-
456 slave the temperature level. In parallel, PV modules can be oriented towards
457 direct or diffuse radiation depending on the weather.

458 Considering the hydraulic system, the primary loop has been improved
459 with the addition of six three-way valves, allowing the use of four receivers

460 in five different modes. From serial mode to parallel mode, the control-
461 command can, in real time, adapt the operation of the primary loop according
462 to the incident radiation, the stored heat and the power of the load. To
463 improve the temperature level, two solar pumps can now regulate the flow
464 of the hydraulic circuit. Servo-control of the outlet temperature can thus be
465 achieved in three different ways: variation of the flow of the hydraulic loop,
466 action on the concentration rate and action on the receiver configurations.

467 The study of the solar parameters made it possible to know at any mo-
468 ment the solar radiation, with or without reflection, on all the elements of
469 the system. For this purpose, system-specific trigonometric calculations of
470 reflection and shadows have been provided, allowing the calculation of the
471 energy optimum. These parameters have been used to determine the optimal
472 position of the receiver with respect to the structure. The receiver should
473 be positioned at a distance of one meter in front of the structure and at a
474 height of 74 cm. The remaining losses are mainly due to the effect of the solar
475 deviation and the fact that the absorbers are spaced apart. To limit these
476 losses, it would be first necessary to remove the space between the absorbers,
477 and then to reduce the azimuth effect by increasing the length of the mirrors
478 or adding reflectors to recover lost energy.

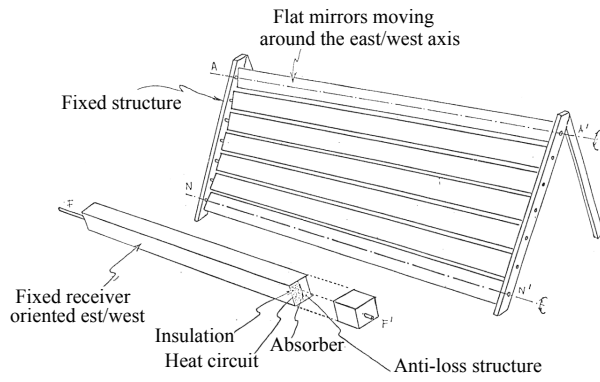

Figure 1: First diagram of the prototype (1981)

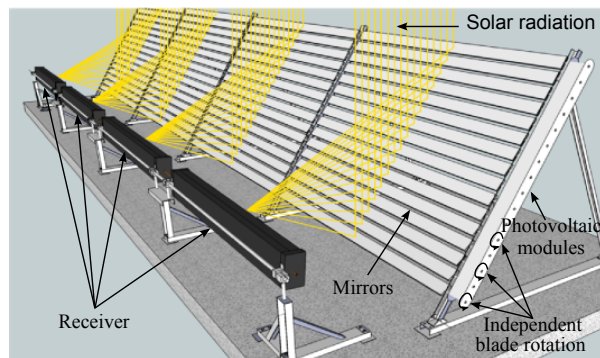

Figure 2: Three-dimensional modelling: thermal part

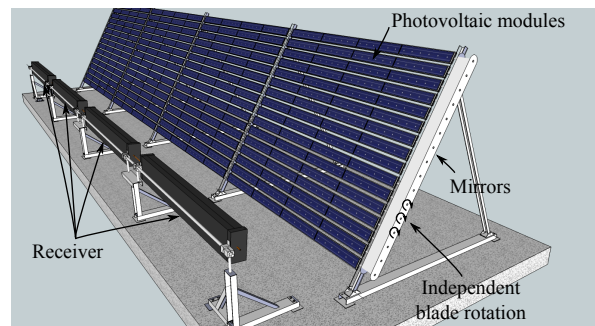

Figure 3: Three-dimensional modelling: electrical part

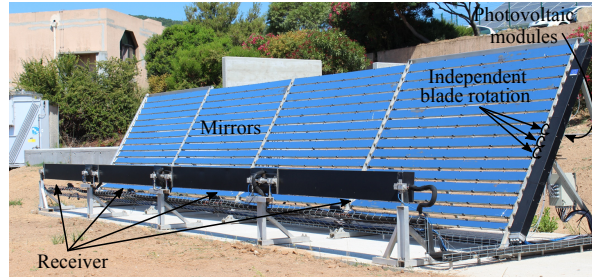

Figure 4: Picture of the solar concentration system

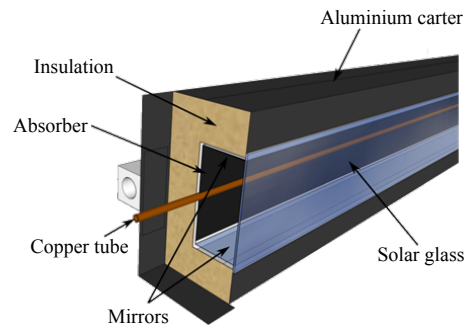

Figure 5: Three-dimensional modelling: receiver

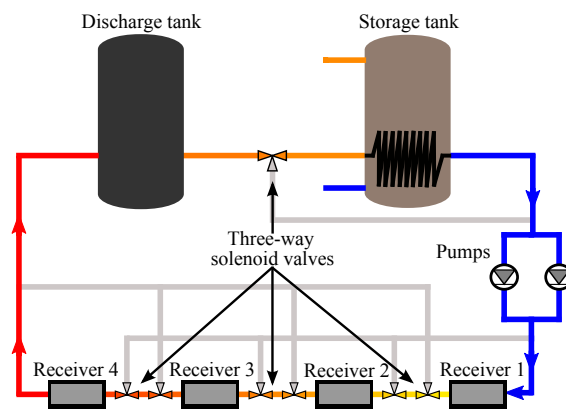

Figure 6: Hydraulic circuit

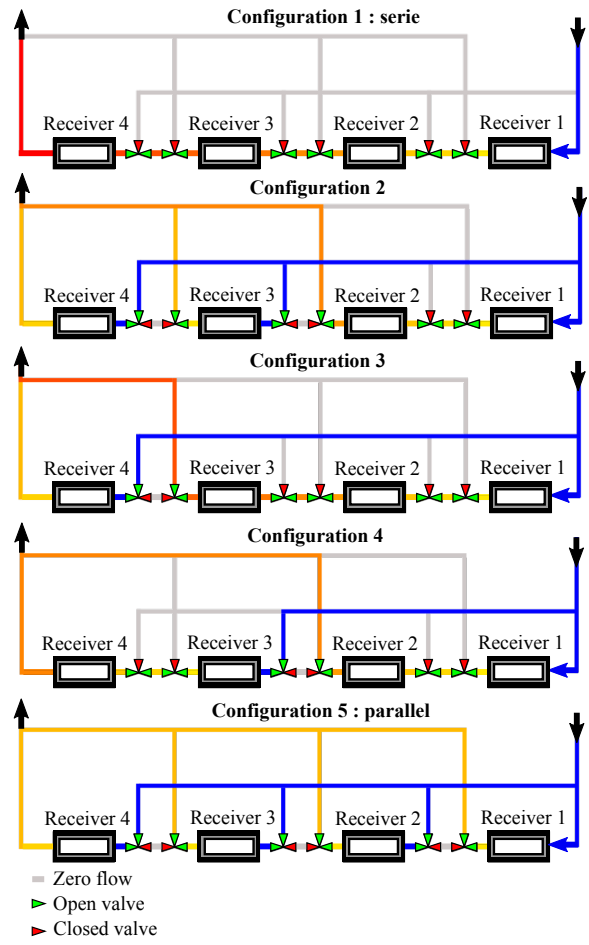

Figure 7: Modular receiver: different configurations possible

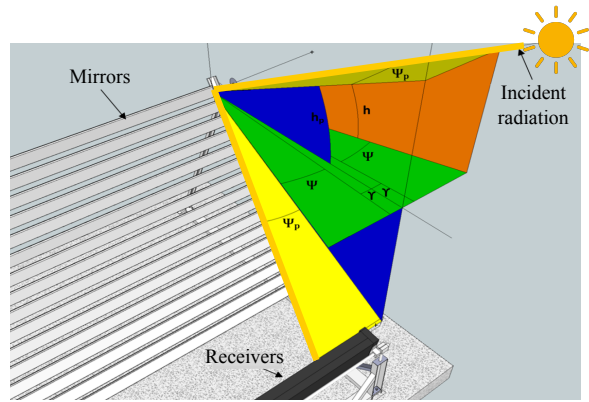

Figure 8: Specific parameters solar system

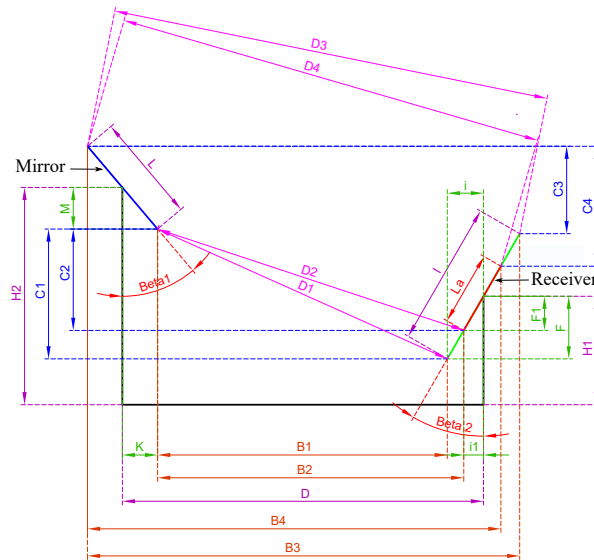

Figure 9: Geometric parameters of the system

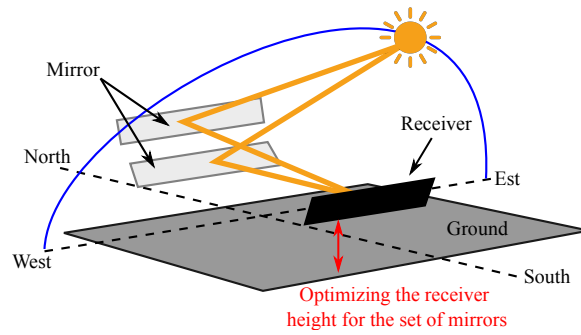

Figure 10: Receiver height optimisation

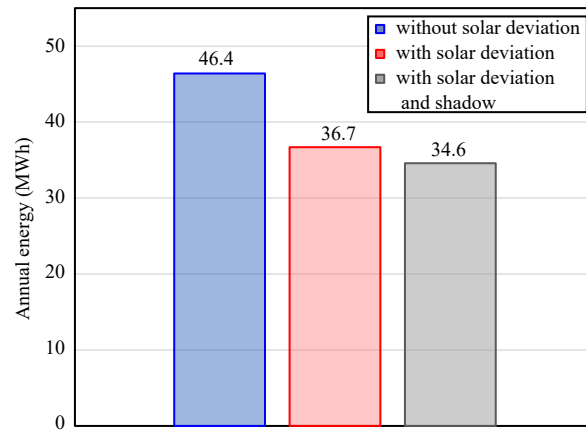

Figure 11: Annual energy received

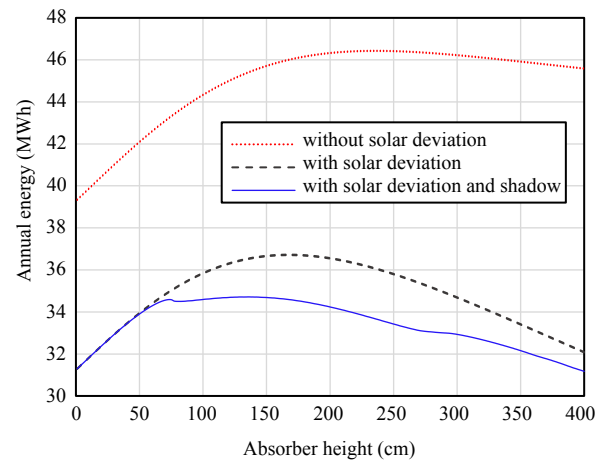

Figure 12: Annual energy received depending on the height of the absorber

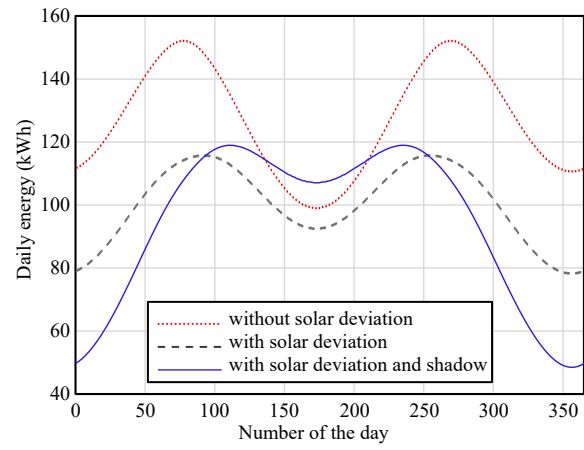

Figure 13: Daily energy

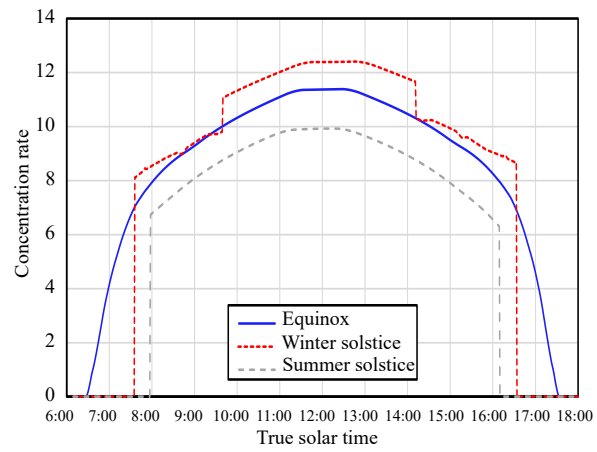

Figure 14: Concentration rate as a function of time

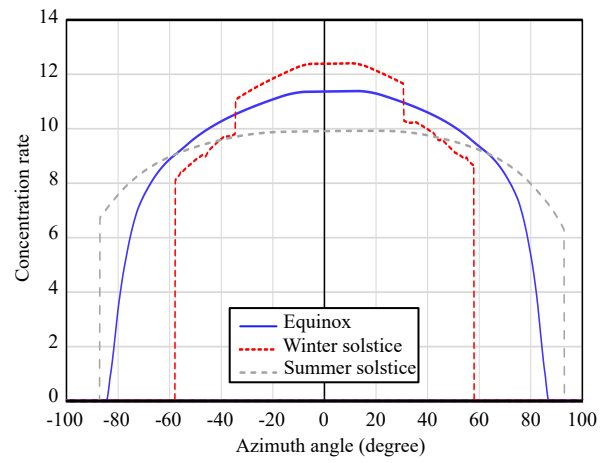

Figure 15: Concentration rate as a function of azimuth angle

479 Appendix A. Geometric parameters of the system

$$K_N = \frac{L \sin(\beta_{1N})}{2} \quad (\text{A.1})$$

$$M_N = \frac{L \cos(\beta_{1N})}{2} \quad (\text{A.2})$$

$$I = \frac{l \sin(\beta_2)}{2} \quad (\text{A.3})$$

$$F = \frac{l \cos(\beta_2)}{2} \quad (\text{A.4})$$

$$I_{1N} = \frac{L_{AN} \sin(\beta_2)}{2} \quad (\text{A.5})$$

$$F_{1N} = \frac{L_{AN} \cos(\beta_2)}{2} \quad (\text{A.6})$$

$$B_{1N} = D_N - I - M_N \quad (\text{A.7})$$

$$B_{2N} = D_N - I_{1N} - M_N \quad (\text{A.8})$$

$$B_{3N} = D_N + I + M_N \quad (\text{A.9})$$

$$B_{4N} = D_N + I_{1N} + M_N \quad (\text{A.10})$$

$$C_{1N} = (H_1 - F) - (H_{2N} - K_N) \quad (\text{A.11})$$

$$C_{2N} = (H_1 - F_{1N}) - (H_{2N} - K_N) \quad (\text{A.12})$$

$$C_{3N} = (H_1 + F) - (H_{2N} + K_N) \quad (\text{A.13})$$

$$C_{4N} = (H_1 + F_{1N}) - (H_{2N} + K_N) \quad (\text{A.14})$$

$$D_{1N} = \sqrt{(B_{1N}^2 + C_{1N}^2)} \quad (\text{A.15})$$

$$D_{2N} = \sqrt{(B_{2N}^2 + C_{2N}^2)} \quad (\text{A.16})$$

$$D_{3N} = \sqrt{(B_{3N}^2 + C_{3N}^2)} \quad (\text{A.17})$$

$$D_{4N} = \sqrt{(B_{4N}^2 + C_{4N}^2)} \quad (\text{A.18})$$

$$\cos(hc_{1N}) = \frac{D_{1N}^2 + D_{2N}^2 - \left(\frac{1}{2} - \frac{L_{AN}}{2}\right)^2}{2 D_{1N} D_{2N}} \quad (\text{A.19})$$

$$\cos(hc_{2N}) = \frac{D_{3N}^2 + D_{4N}^2 - \left(\frac{1}{2} - \frac{L_{AN}}{2}\right)^2}{2 D_{3N} D_{4N}} \quad (\text{A.20})$$

480 **Nomenclature**

481	α_{abs}	Absorbance of the absorber	[]
482	α_{alu}	Absorbance of the aluminum casing	[]
483	α_{glass}	Absorbance of the glass	[]
484	β	Angle of inclination of the structure in relation to the horizontal	[rad]
485	β_{1N}	Angle of inclination of each mirror N with respect to the vertical	[rad]
486	β_2	Angle of inclination of the receivers with respect to the vertical	[rad]
487	δ	Solar declination	[rad]
488	$\eta_{receiver}$	Receiver efficiency	[]
489	η_{SRLO}	Concentration rate	[]
490	γ	Angle of deviation of the south and the normal of the inclined surface	[rad]
491		projected on the ground	
492	ω	Hour angle	[rad]
493	ω_{S_N}	Corrected hour angle of hc_{1_n} ou de hc_{2_n} (which is therefore a function	[rad]
494		of each mirror N)	
495	ϕ	Latitude	[rad]
496	Ψ	Azimuth angle	[rad]
497	Ψ_p	Solar deviation	[rad]
498	τ_{glass}	Transmittance of the glass	[]
499	Θ_{pN}	Angle of incidence projected on the horizontal plane including the	[rad]
500		normal to the mirror N	
501	B_{1N}	Distance projected on the horizontal plane from the lower end of each	[cm]
502		mirror N to the lower end of the receiver	
503	B_{2N}	Distance projected on the horizontal plane from the lower end of each	[cm]
504		mirror N to the lower end of the <i>spot</i>	

505	B_{3N}	Distance projected on the horizontal plane from the upper end of each	
506		mirror N to the upper end of the receiver	[cm]
507	B_{4N}	Ddistance projected on the horizontal plane from the upper end of	
508		each mirror N to the upper end of the <i>spot</i>	[cm]
509	C_{1N}	Difference height between the lower end of each mirror N and the	
510		lower end of the receiver	[cm]
511	C_{2N}	Difference height between the lower end of each mirror N and the	
512		lower end of the <i>spot</i>	[cm]
513	C_{3N}	Difference height between the upper end of each mirror N and the	
514		upper end of the receiver	[cm]
515	C_{4N}	Difference height between the upper end of each mirror N and the	
516		upper end of the <i>spot</i>	[cm]
517	D	Distance projected horizontally between the structure and the re-	
518		ceivers	[cm]
519	D_{1N}	Distance between the lower end of each mirror N and the lower end	
520		of the receiver	[cm]
521	D_{2N}	Distance between the lower end of each mirror N and the lower end	
522		of the <i>spot</i>	[cm]
523	D_{3N}	Distance between the upper end of each mirror N and the upper end	
524		of the receiver	[cm]
525	D_{4N}	Distance between the upper end of each mirror N and the upper end	
526		of the <i>spot</i>	[cm]
527	D_N	Projected distance on the horizontal plane between each mirror N	
528			[cm]
529	F	Projection of the half-width of the receiver on the vertical	[cm]
530	F_{1N}	Projection of the half-width of the <i>spot</i> on the vertical according to	
531		each mirror: N	[cm]
532	h	Angular height of the sun	[rad]

533	H_1	Receiver height	[cm]
534	H_{2N}	Height of each mirror N	[cm]
535	h_{mN}	Difference in angular height between each mirror N and the receivers	[rad]
536			
537	h_p	Angular height of the sun in the north-south plan	[rad]
538	hc_{1N}	Angle scanned by a ray reflected from the top end of each mirror N to	
539		traverse the distance between the top edge of the task and receivers	
540			[cm]
541	hc_{2N}	Angle scanned by a ray reflected from the lower end of each mirror	
542		N to traverse the distance between the bottom edge of the task and	
543		receivers	[cm]
544	I_0	Nominal radiation	[$W.m^{-2}$]
545	I	Projection of the half-width of the receiver on the horizontal	[cm]
546	I_{1N}	Projection of the half-width of the <i>spot</i> on the horizontal according to	
547		each mirror N	[cm]
548	K_N	Projection of the half-width of each N mirror on the horizontal	[cm]
549	L_{1N}	Actual length of the mirror arriving on the absorber	[cm]
550	l_{aN}	Width of the <i>spot</i> on the receiver N	[cm]
551	L_{abs}	Absorber length	[cm]
552	l_{abs}	Absorber width	[cm]
553	L_{glass}	Glass length	[cm]
554	l_{glass}	Glass width	[cm]
555	l_{mirror}	Width of mirrors	[cm]
556	$L_{receiver}$	Receiver length	[cm]
557	$l_{receiver}$	Receiver width	[cm]

558	M_N	Projection of the half-width of each mirror N on the vertical	[cm]
559	N	Number of the mirrors, the lowest mirror corresponds to the number	
560		1 and therefore the highest one corresponds to the number 16	[]
561	P_{1N}	power at a given moment for each mirror N	[W]
562	$S_{abs_{tot}}$	Total area of absorbers	[m^2]
563	S_{abs}	Surface of an absorber	[m^2]
564	$S_{mirror_{tot}}$	Total area of mirrors	[m^2]
565	S_{mirror}	surface of a mirror	[m^2]
566	T_{1N}	Intermediate registration time (third and fourth case with first condi-	
567		tion) according to each mirror N	[s]
568	T_{2N}	Intermediate registration time (third and fourth cases with second	
569		condition) according to each mirror N	[s]
570	T_{N_s}	Resetting time, according to each mirror N	[s]
571	T_N	Exit time, according to each mirror N	[s]
572	X	Distance between each mirror	[cm]

573 **Glossary**

574 **CHP** Combined Heat and Power.

575 **CPVT** Concentrated PhotoVoltaic Thermal.

576 **DER** Distributed Energy Resources.

577 **DG** Distributed Generation.

578 **DHW** Domestic Hot Water.

579 **HEATS** Hybrid Electric And Thermal Solar.

580 **LFR** Linear Fresnel Reflector.

581 **MPPT** Maximum Power Point Tracking.

582 **PVT** PhotoVoltaic-Thermal.

583 **RES** Renewable Energy Sources.

584 **SRLO** Système Réfléchissant à Lames Orientables (Orientable Blades Re-
585 flective System).

586 **References**

- 587 [1] K. Darrow, R. Tidball, J. Wang, A. Hampson, Catalog of CHP Tech-
588 nologies, Tech. rep., U.S. Environmental Protection Agency (Sep. 2017).
- 589 [2] S. S. Joshi, A. S. Dhoble, Photovoltaic -Thermal systems (PVT): Tech-
590 nology review and future trends, *Renewable and Sustainable Energy*
591 *Reviews* 92 (2018) 848–882 (Sep. 2018). doi:10.1016/j.rser.2018.04.067.
- 592 [3] L. A. Weinstein, K. McEnaney, E. Strobach, S. Yang, B. Bhatia, L. Zhao,
593 Y. Huang, J. Loomis, F. Cao, S. V. Boriskina, Z. Ren, E. N. Wang,
594 G. Chen, A Hybrid Electric and Thermal Solar Receiver, *Joule* 2 (5)
595 (2018) 962–975 (May 2018). doi:10.1016/j.joule.2018.02.009.
- 596 [4] M. Li, X. Ji, G. L. Li, Z. M. Yang, S. X. Wei, L. L. Wang, Perfor-
597 mance investigation and optimization of the Trough Concentrating Pho-
598 tovoltaic/Thermal system, *Solar Energy* 85 (5) (2011) 1028–1034 (May
599 2011). doi:10.1016/j.solener.2011.02.020.
- 600 [5] R. Daneshazarian, E. Cuce, P. M. Cuce, F. Sher, Concentrating pho-
601 tovoltaic thermal (CPVT) collectors and systems: Theory, performance
602 assessment and applications, *Renewable and Sustainable Energy Re-*
603 *views* 81 (2018) 473–492 (Jan. 2018).
- 604 [6] G. Peri, R. Masse, J. Tantardini, Solar concentration system medium
605 temperature heliothermal using the concentration of a reflective struc-
606 ture to orientable blades, *Mediterranean Cooperation on Solar Energy*
607 (1980).
- 608 [7] J. Chaves, M. Collares-Pereira, Etendue-matched two-stage concentra-
609 tors with multiple receivers, *Solar Energy* 84 (2) (2010) 196–207 (Feb.
610 2010).
- 611 [8] P. L. Singh, R. M. Sarviya, J. L. Bhagoria, Thermal performance of
612 linear Fresnel reflecting solar concentrator with trapezoidal cavity ab-
613 sorbers, *Applied Energy* 87 (2) (2010) 541–550 (2010).
- 614 [9] D. Beekley, G. Mather, Analysis and experimental tests of a high-
615 performance evacuated tubular collector, Tech. rep. (1975).
- 616 [10] R. Bruno, W. Herman, H. Horster, R. Kersten, F. Mahdjuri, High effi-
617 ciency solar collectors, ISES International Solar Energy Society (1975).

- 618 [11] R. Pasquetti, Numerical determination of point concentration distribu-
619 tion at the focus of faceted concentrators, *Journal of Physics* 19 (6)
620 (1984).
- 621 [12] R. Pasquetti, G. Peri, A. Louche, A new approach for designing a solar
622 concentrating system, *Journal of Physics* (1987).
- 623 [13] J. Canaletti, Study and design of the enslavement of a solar radiation
624 concentration device (1990).