



HAL
open science

Optimization of the cooling capacity of the cryo-magnetic system for EU DEMO at the pre-conceptual design phase

François Bonne, Christine Hoa, Quentin Le Coz, Louis Zani, Benoît Lacroix,
Jean-Marc Poncet

► To cite this version:

François Bonne, Christine Hoa, Quentin Le Coz, Louis Zani, Benoît Lacroix, et al.. Optimization of the cooling capacity of the cryo-magnetic system for EU DEMO at the pre-conceptual design phase. Fusion Engineering and Design, 2019, 146, pp.2504 - 2508. 10.1016/j.fusengdes.2019.04.028 . hal-03487282

HAL Id: hal-03487282

<https://hal.science/hal-03487282>

Submitted on 20 Jul 2022

HAL is a multi-disciplinary open access archive for the deposit and dissemination of scientific research documents, whether they are published or not. The documents may come from teaching and research institutions in France or abroad, or from public or private research centers.

L'archive ouverte pluridisciplinaire **HAL**, est destinée au dépôt et à la diffusion de documents scientifiques de niveau recherche, publiés ou non, émanant des établissements d'enseignement et de recherche français ou étrangers, des laboratoires publics ou privés.



Distributed under a Creative Commons Attribution - NonCommercial 4.0 International License

Optimization of the cooling capacity of the cryo-magnetic system for EU DEMO at the pre-conceptual design phase

François Bonne^a, Christine Hoa^a, Quentin Le Coz^b, Louis Zani^b, Benoît Lacroix^b, Jean-Marc Poncet^a

^aUniv. Grenoble Alpes, CEA INAC-SBT, Grenoble 38000 France

^bCEA IRFM, Saint Paul lez Durance 13018 France

The cryo-magnetic system of the future tokamak EU DEMO includes the superconducting magnets cooled by a forced flow of supercritical helium at about 4.5 K, the cryo-distribution lines and valve boxes, and the cryogenic system with several cold boxes. The DEMO cryogenic system is at the pre-conceptual design phase, with the identification of the heat loads requirements of the main cryogenic users. The analysis will focus on the cooling capacity of the superconducting magnets, with the application on a toroidal field coil conductor based on a CEA design. Simcryogenics, a dynamic modelling tool developed by CEA, has been used to model a supercritical helium loop for cooling one conductor pancake. An algorithm has been developed to optimize the cold source temperature and the supercritical helium mass flow, in order to minimize the refrigeration power. At this pre-conceptual design phase, the interest of such analysis is to contribute to the optimization of both the cryogenic system and the superconducting magnets to minimize the refrigeration power, one of the important investment and operation costs for the future tokamak.

Keywords: DEMONstration fusion reactor (DEMO), fusion, simulation, refrigeration, optimization.

1. Introduction

In the framework of EU DEMO pre-conceptual design phase, different Toroidal Field (TF) coil conductor designs are under study [1]. In the thermal hydraulic analyses [2], the inlet temperature and pressure of the supercritical helium flow are commonly chosen at 4.5 K and 5 bar to simulate the cooling circuits of the conductors, with a maximum pressure drop of 1 bar. These boundary conditions and design parameters rely on previous magnet designs (JT-60SA, ITER) and an arbitrary fixed interface with the cryogenic system. This study aims at investigating these common values and propose an optimization method to calculate the total refrigeration power on a complete model of the supercritical helium loop and a liquid helium bath (cold source) connected to the cold end of the refrigerator (Fig. 1). CEA has developed Simcryogenics [3] to model and perform optimization process calculations.

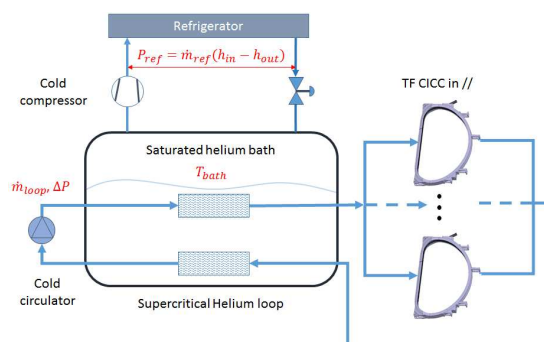

Fig. 1. Optimization model of the refrigeration power of a supercritical helium loop

2.1 Simcryogenics model

The Simcryogenics model (Fig. 2) is composed of a liquid helium bath (PS1) supplied by a Joule-Thomson valve (CV1). The bath pressure is regulated by the cold compressor C1. Two heat exchangers are immersed in the liquid helium bath and extract the thermal loads of the supercritical helium loop driven by the cold circulator C2. The 111.56 kA TF conductor is a CEA design inspired from ITER magnets, with pancake-wound coils, using Nb₃Sn cable in conduit conductor (CICC) [1-2] (Table 1). The CICC is modelled with two 1-D pipes in parallel for simulating the repartition of the flows in the bundle and the central channel. The friction factor and heat transfer coefficient correlations are described in [2]. The heat transfer between the central channel and the bundle has been modeled and the mass transfer has been assumed negligible.

Table 1. CEA Toroidal Field coil conductor characteristics

Conductor current (kA)	111.56
Material	Nb ₃ Sn -Cu
B_{max} (T)	12.3
Central spiral (mm) o.d*i.d	10*8
Bundle D_h (m)	$0.48 \cdot 10^{-3}$
Bundle Wetted perimeter (m)	5.39
Void fraction (%)	29
Friction factor Bundle	Darcy-Forchheimer correlation
Friction factor Central spiral	Smooth tube correlation
Heat transfer coefficient	Dittus Boelter correlation
Hydraulic Length (m)	363.86
Number of double pancakes	8
Number of turns per pancake	8

2. 1D thermal hydraulic model for the conductor

author's email: christine.hoa@cea.fr

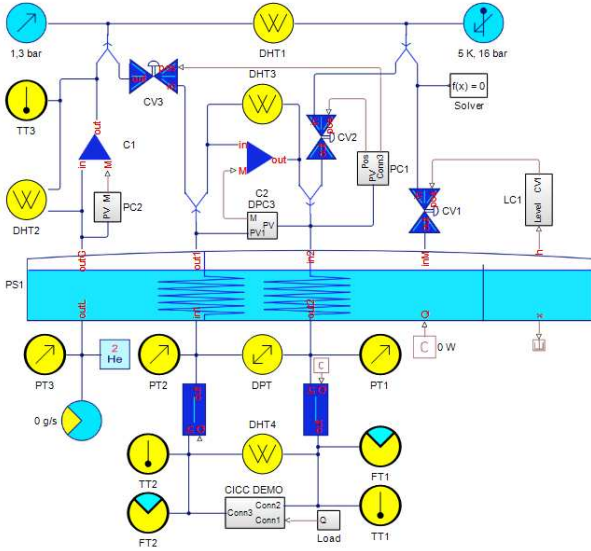

Fig. 2 Simcryogenics model with one TF conductor

2.2 Boundary conditions

The thermal loads on the TF conductor (mostly nuclear heating and a small contribution of conductor losses) is non-uniformly distributed along one pancake length (Fig. 3). The total amount of loads is about 10 Watts. This thermal hydraulic analysis includes the thermal coupling of the inter-turn along the conductor and also the thermal coupling between two adjacent pancakes. One TF coil is composed of eight double pancakes and each pancake has 8 turns featured on Fig.4 although the two last turns are less visible. The current sharing temperature T_{CS} is derived from the magnetic field distribution along the TF conductor (Fig 4). The temperature margin is critical in the first 50 meters of the conductor, where the magnetic field is the highest.

The total refrigeration loads are calculated at the interface of the refrigerator with an enthalpy balance calculation. At the interface with the cold end of the refrigerator, the high pressure flow is fixed at 16 bar and 5 K upstream the Joule Thomson valve, whereas the outlet of the compressor is fixed at 1.3 bar. These boundary conditions are common values in the helium refrigeration process of tokamaks, for example in JT-60SA [7].

The total refrigeration load covers the thermal load along the TF conductor, the static heat losses along the cryogenic lines but includes also the pumping powers of the cold circulator and the cold compressor, which represent a cryo-distribution load depending on the process parameters \dot{m}_{loop} or ΔP and P_{bath} .

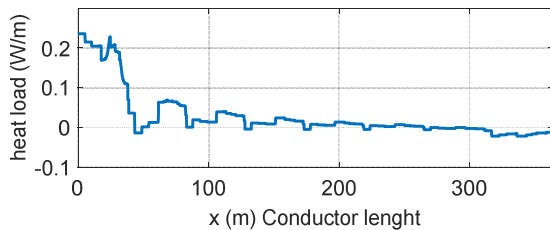

Fig. 3 Heat load profile distribution along the TF conductor

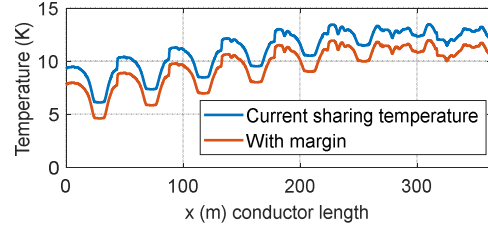

Fig. 4 Current sharing temperature T_{cs} (blue) and the maximum operating temperature of the conductor with 1.5K margin (red)

3. Optimization of the refrigeration power

3.1 Iterative process

Fig. 5 describes the iterative process with the calculation of the thermal hydraulic characteristics ($\Delta P, T_{bath}$) with two thermal hydraulic codes. THEA+Cast3M [4-5] focusses on the 2-D model of a TF coil, taking into account transverse thermal coupling for computing the heat load distribution $Q_{CICC}(x, t)$ [6]. The latter serves as an input for the macroscopic model of the cooling circuit of one central pancake with Simcryogenics. The present study focuses on the central pancake since it is the most critical one regarding the temperature margin because of the highest magnetic field and an increased heat load from the casing. The scale down ratio of 1/16 has been applied to the mass flow through the cryolines and their pressure drops are negligible compared to the contribution of the TF circuits.

3.2 Optimization problem

The optimization problem aims at minimizing the refrigeration power by playing on the pressure drop (or the mass flow) along the supercritical helium loop and the cold source T_{bath} under the constraint that the temperature margin along the conductor, with respect of the current sharing temperature, is higher than $\Delta T_m = 1.5 K$.

$$P_{ref}(\Delta P, T_{bath}) = \begin{cases} \min: P_{ref} \\ \text{s.t.} : T_{cicc}(x) \leq T_{cs}(x) - \Delta T_m \end{cases}$$

The THEA+Cast3M model is run again with the optimized boundary conditions $(\Delta P, T_{bath})_{optim}$ to evaluate an update of the heat load profile. Several iterations are performed to converge towards an optimal set of thermal-hydraulic parameters $(\Delta P, T_{bath})_{optim}$.

4. Optimization results

4.1 Reference conditions

The reference thermal hydraulic boundary conditions based on previous magnet design for JT-60SA and ITER are commonly: $\Delta P=1$ bar (corresponding to a mass flow of 12.5 g/s per conductor) and $T_{bath} = 4.45 K$, which corresponds to 4.5 K at the inlet of the TF coil. The total required refrigeration power is 23.6 watts (Fig. 6). A large contribution is due to pumping power of the cold circulator C2: 13 W (55%).

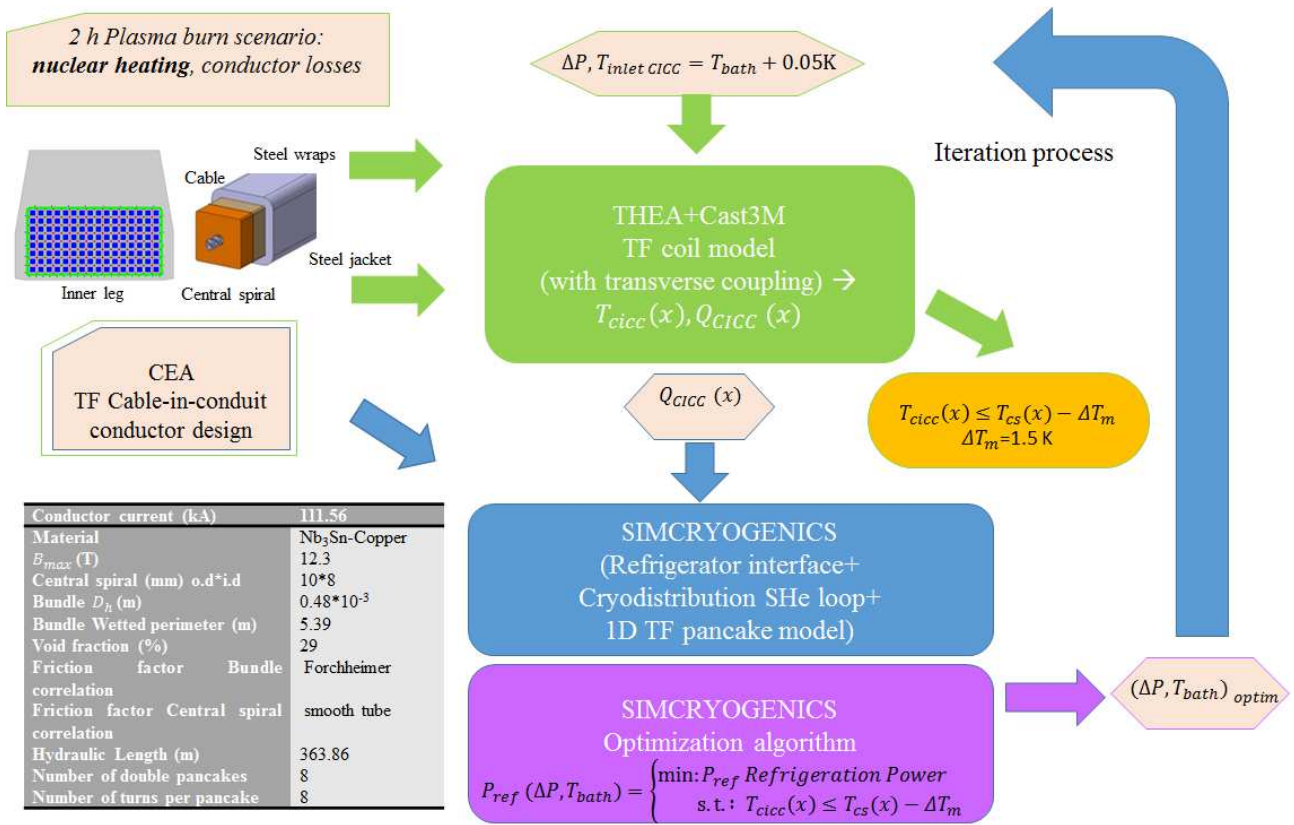

Fig. 5 Iterative process for optimal thermal hydraulic parameters $(\Delta P, T_{bath})_{optim}$.

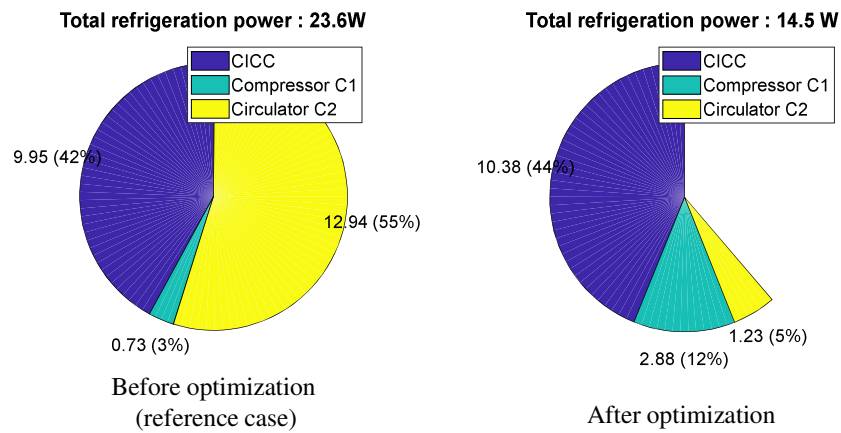

Fig. 6. Optimization results

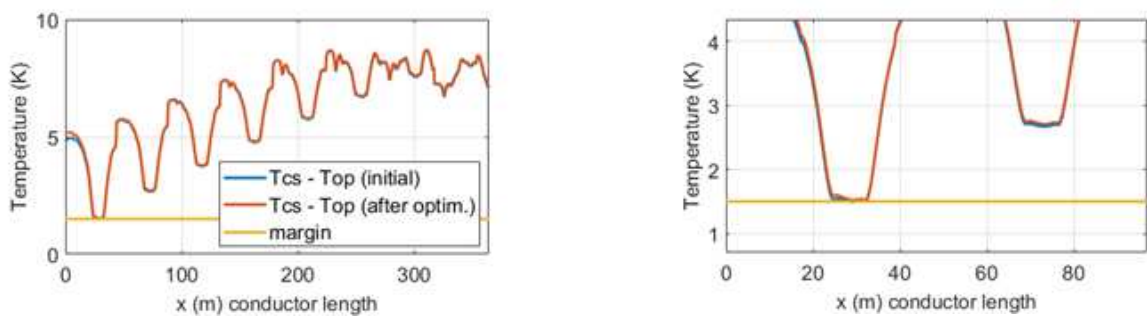

Fig. 7. Tcs-Top profiles along the TF conductor and the 1.5 K temperature margin criteria

4.2 Optimization

The optimization algorithm finds a minimum refrigeration power of 13 W after three iterations with the following thermal hydraulic parameters: $\Delta P_{optim} = 0.23$ bar, corresponding to a mass flow of 5.35 g/s and $T_{bath} = 4.16$ K.

The total refrigeration power has been reduced from 23.6 to 14.5 W (-39%). The algorithm has optimized the cryo-distribution loads with a trade-off between the cold circulator and the cold compressor pumping powers. The energy saving is mainly due to the decrease of the pumping power of the cold circulator C2 from 13 W to 1.2 W. The cold compressor C1 for pumping the liquid helium bath down to the saturated pressure corresponding to 4.16 K, requires 2.9 W instead of 0.8 W (4.45 K). Its contribution has increased from 3% to 12% of the total refrigeration load. The additional cost required to reach 4.16 K in the bath is largely counterbalanced by the decrease of the mass flow and pressure drop of the SHe loop (5.35 g/s and 0.23 bar).

4.3 Exergetic comparison

From an exergetic point of view, the rigorous comparison is performed by calculating the equivalent refrigeration powers at 300 K. With an ideal Carnot factor, the refrigeration powers at 300 K would be 2.9 kW for cooling one conductor pancake with the reference conditions. The optimized case would require at 300 K 1.7 kW (-44%). The real process of large helium refrigerator is known to have efficiency around 25% with respect to Carnot factor, so the expected electrical powers are much higher. The global efficiency depends on the other cooling processes related to the cryogenic users, not only the TF magnets but also the central solenoid and poloidal coils. The thermal shields cooled at about 80 K and the high temperature superconducting current leads cooled at about 50 K also contribute to the total refrigeration power, with specific efficiency related to different temperature levels.

4.4 Conductor temperature profiles

The resulting spatial distribution (after optimization) of the conductor temperature $T_{cicc}(x)$ is described in Fig. 7 and is compared with the distribution with the reference conditions (before optimization). The temperature profile has not much changed, except for the first 50 meters, where the temperature of the conductor is close to the acceptable margin of 1.5 K with respect to the current sharing temperature. For this double pancake design, the driving parameters for the cooling is related to the first 50 meters.

5. Conclusion and perspectives

A Simcryogenics model and an algorithm have been developed to optimize the thermal-hydraulic parameters of the cryo-distribution of one conductor pancake. An optimal configuration has been found which reduces significantly the equivalent refrigeration power at 300 K (-44%). Hence the common values for the boundary

conditions ($\Delta P=1$ bar, $T_{inlet\ cicc} =4.5$ K) of the TF coil can be revised for an optimization of the refrigeration power.

In the case of the CEA design with pancake wound conductor, a lower pressure drop (0.23 bar) and a lower inlet temperature (4.16+0.05K) could benefit from a reduced refrigeration, with an acceptable temperature margin > 1.5 K along the conductor length.

The model and the algorithm will be relevant for comparing different conductor designs (graded layer designs) [1]. This optimization method is well adapted to the pre-conceptual studies on TF conductors and can be included in the iterative conductor design calculations in complement with the thermal hydraulic analyses.

The Simcryogenics model would be also improved to include the inter-turn transverse coupling along one pancake which has been accounted for in the THEA/CAST3M model and which also includes the cooling channels of the structures in the present study. Hence the optimization process could be simplified with a single calculation with Simcryogenics.

Another potential study of the Simcryogenics model is the evaluation of the impact of the temperature margin on the required refrigeration power.

Acknowledgments

This work has been carried out within the framework of the EUROfusion Consortium for the EU-DEMO magnet work package WPMAG. The views and opinions expressed herein do not necessarily reflect those of the European Commission.

References

- [1] V. Corato et al., Progress in the design of the superconducting magnets for the EU DEMO, Fusion Engineering and Design 136 (2018) 1597-1604.
- [2] R. Vallcorba et al., Thermohydraulic analyses on CEA concept on TF and CS coils for EU DEMO, IEEE Trans. Appl. Supercond., 28 (2018), Article no. 4202605.
- [3] F. Bonne, M. Alamir, C. Hoa, P. Bonnay, M. Bon-Mardion, and L. Monteiro, A simulink library of cryogenic components to automatically generate control schemes for large cryorefrigerators, IOP Conference Series: Materials Science and Engineering, 101(1):012171 (2015).
- [4] <http://cryosoftsupport.wixsite.com/cryosoft>.
- [5] <http://www-cast3m.cea.fr>.
- [6] Q. Le Coz, D. Ciazynski, B. Lacroix, S. Nicollet, F. Nunio, A. Torre, R. Vallcorba, L. Zani, Towards a multi-physic platform for fusion magnet design. Application to DEMO TF coil. Fusion Engineering and Design 124 (2017) 104–109.
- [7] C. Hoa et al., Performance of the JT-60SA cryogenic system under pulsed heat loads during acceptance tests, IOP Conference Series: Materials Science and Engineering, Volume 278, conference 1 (2017).