



HAL
open science

Multi-surface plasticity model for concrete with 3D hardening/softening failure modes for tension, compression and shear

Emir Karavelić, Adnan Ibrahimbegovic, Samir Dolarević

► **To cite this version:**

Emir Karavelić, Adnan Ibrahimbegovic, Samir Dolarević. Multi-surface plasticity model for concrete with 3D hardening/softening failure modes for tension, compression and shear. *Computers & Structures*, 2019, 221, pp.74 - 90. <10.1016/j.compstruc.2019.05.009>. <hal-03485833>

HAL Id: hal-03485833

<https://hal.science/hal-03485833v1>

Submitted on 20 Dec 2021

HAL is a multi-disciplinary open access archive for the deposit and dissemination of scientific research documents, whether they are published or not. The documents may come from teaching and research institutions in France or abroad, or from public or private research centers.

L'archive ouverte pluridisciplinaire **HAL**, est destinée au dépôt et à la diffusion de documents scientifiques de niveau recherche, publiés ou non, émanant des établissements d'enseignement et de recherche français ou étrangers, des laboratoires publics ou privés.



Distributed under a Creative Commons CC BY-NC 4.0 - Attribution - Non-commercial use - International License

Multi-surface plasticity model for concrete with 3D hardening/softening failure modes for tension, compression and shear

Emir Karavelić^{a,b}, Adnan Ibrahimbegovic^{a,*}, Samir Dolarević^b

^aUniversité de Technologie de Compiègne/Alliance Sorbonne Université, Laboratoire Roberval de Mécanique, Centre de Recherche Royallieu, 60200 Compiègne, France

^bUniversity of Sarajevo, Faculty of Civil Engineering, 71000 Sarajevo, Bosnia and Herzegovina

Abstract

In this work we develop multi-surface plasticity model which can reproduce the inelastic behavior and failure modes of concrete in tension, compression and shear. The main novelty of the proposed concrete model can also capture all different phases of localized failure for massive structures, where the elastic behavior is followed by the creation of the fracture process zone with a large number of micro-cracks and subsequent final failure mode with micro-cracks coalescence into the macro-crack. The fracture process zone is represented by homogenized plasticity criterion with hardening (in particular the non-associated Drucker-Prager) since the number of micro-cracks is considered sufficiently large and their orientation random. The macro-crack is represented with a surface of displacement discontinuity, which is typical of all localized dissipative mechanisms due to the apparition and development of localization zones. The main novelty of proposed model is to provide the full set of 3D localization modes for tension, for compression and for shear, with each mode using corresponding fracture energy.

Keywords: Concrete localized failure model, Non-associated plasticity, Multi-surface yield criteria ;, principal space formulation, embedded discontinuity

1. Introduction

The intensive investigations made over recent years have led to a much better understanding of the constitutive behavior of concrete under complex loading conditions. A variety of constitutive models have been proposed, and many of them are phenomenological. In order to achieve a more reliable estimate of the limit load and structural design, it is required to provide model which describe not only pre-failure hardening regime but also post-peak softening response. The evolution in the behavior of quasi-brittle materials, especially concrete, submitted to quasi-static external mechanical loads, compression or tension, is initially characterized by a quasi-elastic phase, in which the material can recover its initial state upon unloading. Then, as the load increases, microcracks (the size of which depend on the material components) appear in a regular way

and will coalesce to form a macrocrack. This macrocrack will grow and spread until the final material fractures. The appearance and development of these cracks play an essential role in the failure or collapse of concrete structures. Several proposed approaches, enable us to describe this behavior, range from discrete crack concepts [1, 2], either with or without remeshing, to various types of smeared crack concepts, either with fixed or with rotating fracture planes [3, 4]. The deficiency of discrete crack models is the dependence on mesh alignment, when separation can occur only at elements interfaces. To remedy this, special, computer intensive remeshing techniques are required that attempt to predict the crack propagation direction [5]. The weakness of smeared crack models is their inherent dependency on element size and alignment, arising from the ill-posed nature of the classical continuum when applied for softening materials. This method provides no information over crack direction nor is the necessary length scale (so-called crack bandwidth) mesh objective. The application of gradient [6] and non-local [7, 8, 9] continuum theories has proved successful in overcoming the

*Corresponding author

Email address: adnan.ibrahimbegovic@utc.fr (Adnan Ibrahimbegovic)

deficiency of the classical continuum when analyzing softening materials. All the modifications of this kind requires a fine mesh within the localisation zone in order to capture the high strain gradients or in other words a priori knowledge of where failure will occur. Thus, the potential of such methods for structural scale problems, especially in three-dimensions is limited. For that reason, they are often replaced by a particular modification of the classical continuum that allows for either displacement [10, 11, 12, 13, 14, 15, 16, 17, 18, 23, 24] or strain discontinuities in the formulation [19, 20, 21]. The main advantage of the modified continuum models of this kind is to provide the adequate measure of the total inelastic dissipation of the strain softening component regardless of the chosen finite element mesh. However, the vast majority of previous works are mainly developed by combining elastic response with strain softening and thus completely ignore the possible inelastic deformation in fracture process zone that proceeds the strain-softening. In some previous work based on smeared crack concept the inelastic deformation during hardening is taken into account [22]. Moreover, it is well known by now that the nonlinear volume change during hardening is prominent feature of concrete-like materials. This sort of behavior generally violates the associated flow rule. Therefore a separate plastic potential rather than loading function is needed to define flow rule.

In this work, we develop a model capable of taking into account both the contribution of a strain hardening with non-associative flow rule as well as a strain softening model components. We consider here plasticity model with Drucker-Prager yield criterion, with similar plastic potential function governing hardening behavior and corresponding shear line representing the strain softening behavior. Although the plasticity model is used in present study, one can note that damage model could be used as well. However, as long as we do not go to true cyclic loading applications, either of them can be successfully applied to obtain the adequate value of limit load in quasi-static applications. Such a model can provide a more realistic representation of the limit state of a massive structural system where both kind of inelastic dissipations (both strain-hardening and strain softening) are considered. Another advantage of proposed model is ability to represent nonlinear volume change during hardening obtained by using plastic potential function similar to yield function in order to define flow rule.

The condition which allows to connect pre- and post-localization state, pertains to imposing the equivalence of the corresponding dissipations, which can be cast as

the stress orthogonality with respect to localization induced enhanced strain field. The standard finite element implementation ought to be modified in order to account for this orthogonality condition and addition of corresponding displacement modes representing displacement discontinuity along yield line, which can be carried out in a very similar manner as for the method of incompatible modes [25].

Other multi-surface model ingredients pertains of St. Venant criterion that can handle failure in tension and in compression. Figure 1.a shows a graphic illustration of the proposed criterion in principal axes of stress tensor. One can note that in tension region elastic stage is followed by softening, while in compression not only the ductile part with fracture process zone is larger, but also its contribution to total dissipation for compression failure. Figure 1.b clearly reveals that the only special load case which is not limited, is a three-axial compression that can be produced by hydrostatic pressure.

The outline of the paper is as follows. In the next section we briefly present the theoretical framework capable of accommodating both strain-hardening and strain-softening effects. We first start with hardening for non-associative flow rule written in six-dimensional and in principal stress space followed by softening plasticity model. Considerations of the discrete approximation, based on the finite element method, are given in Section 3. The results for several numerical examples are presented in Section 4. In Section 5 we state some closing remarks.

2. Continuum model formulation

In this section, we present the concrete model built in the view of failure models for massive structures, where the elastic behavior is followed by the creation of the fracture process zone with a large number of micro-cracks and subsequent final failure mode in terms of the macro-cracks. The fracture process zone is represented by the non-associated Drucker-Prager continuum plasticity model since the number of micro-cracks is considered sufficiently large and their orientation random. The macro-crack is represented with a surface of displacement discontinuity, where all localized dissipative mechanisms will led to development of localization zones.

2.1. Thermodynamics framework

To simplify our discussion we consider the Euclidean setting and corresponding tensor [10]. We consider the

displacement vector, \mathbf{u} , as a function of both space position \mathbf{x} and pseudo-time t

$$\mathbf{u}(\mathbf{x}, t) = u_i(\mathbf{x}, t)\mathbf{e}_i; \quad \mathbf{x} = x_i\mathbf{e}_i \quad (1)$$

Standard kinematic considerations define the tensor of total strains, $\boldsymbol{\epsilon}$, as the symmetric part of the displacement gradient tensor

$$\boldsymbol{\epsilon} = \nabla^s \mathbf{u}; \quad \epsilon_{ij}\mathbf{e}_i \otimes \mathbf{e}_j = \frac{1}{2} \left(\frac{\partial u_i}{\partial x_j} + \frac{\partial u_j}{\partial x_i} \right) \mathbf{e}_i \otimes \mathbf{e}_j \quad (2)$$

The hypothesis of small displacement gradient allows us to express the equilibrium equations in terms of Cauchy (or true) stress, $\boldsymbol{\sigma} = \sigma_{ij}\mathbf{e}_i \otimes \mathbf{e}_j$ directly in the initial configuration

$$\text{div}[\boldsymbol{\sigma}] + \mathbf{b} = \mathbf{0} \iff \frac{\partial \sigma_{ij}}{\partial x_j} + b_i = 0 \quad (3)$$

where \mathbf{b} is the body force. In elasticity the constitutive model is governed by Hooke's law which only requires to specify the material parameters that allows to construct corresponding elasticity tensor \mathbf{C}

$$\boldsymbol{\sigma} = \mathbf{C}\boldsymbol{\epsilon}; \quad \sigma_{ijkl} = C_{ijkl}\epsilon_{kl} \quad (4)$$

The elasticity tensor of the simplest case of isotropic material (we refer to [26] where fine scale model confirms that concrete is statistically close to isotropic) can be constructed with two parameters only; by choosing Lamé's parameters, λ and μ , we can write such an elasticity tensor as:

$$\mathbf{C} = \lambda \mathbf{1} \otimes \mathbf{1} + 2\mu \mathbf{I} \quad (5)$$

with \mathbf{I} and $\mathbf{1}$ being, respectively, fourth and second order unit tensors. Alternatively, the elasticity tensor can be expressed in terms of bulk (K) and shear modulus (G)

$$\mathbf{C} = K\mathbf{1} \otimes \mathbf{1} + 2G\left(\mathbf{I} - \frac{1}{3}\mathbf{1} \otimes \mathbf{1}\right) \quad (6)$$

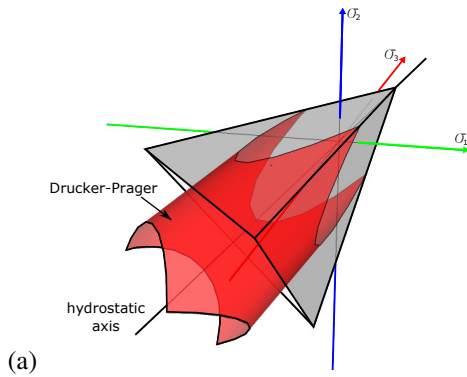

In the presence of plastic deformation, the constitutive relation in (4) is no longer featuring the total but the elastic deformation. Namely, by assuming the independence of the elastic response on plastic flow, the total deformation can be split additively into elastic $\boldsymbol{\epsilon}^e$ and plastic part $\boldsymbol{\epsilon}^p$,

$$\boldsymbol{\epsilon} = \boldsymbol{\epsilon}^e + \boldsymbol{\epsilon}^p \quad (7)$$

By further assuming that the elastic response remains linear, reducing to Hooke's law in (4) in the absence of plastic deformation, we can construct the free energy potential as a quadratic form in terms of deformations

$$\psi(\boldsymbol{\epsilon}, \boldsymbol{\epsilon}^p, \zeta) := \frac{1}{2}(\boldsymbol{\epsilon} - \boldsymbol{\epsilon}^p) \cdot \mathbf{C}(\boldsymbol{\epsilon} - \boldsymbol{\epsilon}^p) + \frac{1}{2}\zeta K \zeta \quad (8)$$

Besides the stress tensor $\boldsymbol{\sigma}$ we define the stress-like internal variable q , which is dual to the strain-like internal state variable ζ . We assume that this dual variable is used to define the yield criterion which corresponds to the classical Drucker-Prager model:

$$\phi_y(\boldsymbol{\sigma}, q) := \|\text{dev}[\boldsymbol{\sigma}]\| + \frac{1}{3}\tan(\varphi)\text{tr}[\boldsymbol{\sigma}] - \sqrt{\frac{2}{3}}(\sigma_y - q) \quad (9)$$

where

$$\text{dev}[\boldsymbol{\sigma}] = \boldsymbol{\sigma} - \frac{1}{3}(\text{tr}[\boldsymbol{\sigma}])\mathbf{1} \quad (10)$$

is the deviatoric part of the stress tensor, $\tan(\varphi)$ is material parameter that can characterize the internal friction and σ_y is uni-axial yield stress identified from a tension test. In (10) the Frobenius norm is used with $\|\boldsymbol{\sigma}\| := \sqrt{\boldsymbol{\sigma} : \boldsymbol{\sigma}}$. Instead to the yield function, plastic flow develops along the normal to the plastic potential function resulting with non-associated Drucker-Prager model. Here, we will use plastic potential function that is different then yield function

$$\phi_p(\boldsymbol{\sigma}, q) := \|\text{dev}[\boldsymbol{\sigma}]\| + \frac{1}{3}\tan(\psi)\text{tr}[\boldsymbol{\sigma}] \quad (11)$$

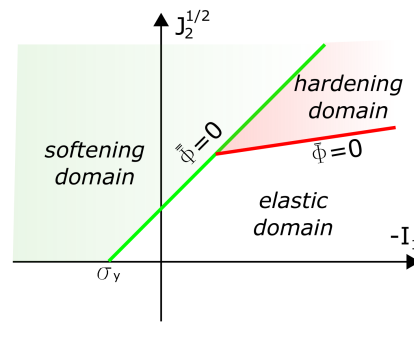

Figure 1: Multisurface criterion (a) in principal stress space (b) in meridian plane

where $\tan(\psi)$ is material parameter describing the angle of dilatancy.

Specifying three fundamental equations in (7), (8) and (9) along with (11), are sufficient to completely define the stress tensor computation as well as the internal variables evolution corresponding to the plasticity model. Namely, we simply use the second principle of thermodynamics and the principle of maximum plastic dissipation. For the isothermal case of dissipation inequality, we have:

$$\begin{aligned} 0 \leq D &:= \boldsymbol{\sigma} \cdot \dot{\boldsymbol{\epsilon}} - \frac{\partial \psi}{\partial t} \\ &= \boldsymbol{\sigma} \cdot \dot{\boldsymbol{\epsilon}} - \frac{\partial \psi}{\partial \boldsymbol{\epsilon}} \cdot \dot{\boldsymbol{\epsilon}} - \frac{\partial \psi}{\partial \boldsymbol{\epsilon}^p} \cdot \dot{\boldsymbol{\epsilon}}^p - \frac{\partial \psi}{\partial \zeta} \cdot \dot{\zeta} \\ &= (\boldsymbol{\sigma} - \frac{\partial \psi}{\partial \boldsymbol{\epsilon}}) \cdot \dot{\boldsymbol{\epsilon}} - \frac{\partial \psi}{\partial \boldsymbol{\epsilon}^p} \cdot \dot{\boldsymbol{\epsilon}}^p - \frac{\partial \psi}{\partial \zeta} \cdot \dot{\zeta} \end{aligned} \quad (12)$$

In the elastic case, where plastic dissipation remains equal to zero with no change of internal variables, $\dot{\boldsymbol{\epsilon}}^p = \mathbf{0}$ and $\dot{\zeta} = 0$, the last result confirms that the stress can be computed as:

$$D = 0; \quad \dot{\boldsymbol{\epsilon}}^p = \mathbf{0}; \quad \dot{\zeta} = 0; \quad \boldsymbol{\sigma} := \frac{\partial \psi}{\partial \boldsymbol{\epsilon}} = \mathbf{C}(\boldsymbol{\epsilon} - \boldsymbol{\epsilon}^p) \quad (13)$$

By assuming that such a stress computation remains valid in the plastic case, and by introducing the thermodynamic fluxes conjugate to internal variables,

$$\boldsymbol{\sigma} := -\frac{\partial \psi}{\partial \boldsymbol{\epsilon}^p} \quad q := -\frac{\partial \psi}{\partial \zeta} \quad (14)$$

we can obtain the final expression for the plastic dissipation according to:

$$0 \leq D^p := \boldsymbol{\sigma} \cdot \dot{\boldsymbol{\epsilon}}^p + q \cdot \dot{\zeta} \quad (15)$$

The principle of maximum plastic dissipation is then invoked stating that among all the admissible stress states (for which $\phi_y(\boldsymbol{\sigma}, q) \leq 0$), we ought to choose those which maximize the plastic dissipation:

$$D^p(\boldsymbol{\sigma}, q) = \max_{\phi_y(\boldsymbol{\sigma}^*, q^*) \leq 0} [D^p(\boldsymbol{\sigma}^*, q^*)]; \quad (16)$$

By the Lagrange multiplier method, this problem of computing the maximum under the corresponding constraint can be transformed into an unconstrained minimization problem:

$$\begin{aligned} L^p(\boldsymbol{\sigma}, q, \dot{\gamma}) &= \max_{\dot{\gamma} \geq 0} \min_{\forall \boldsymbol{\sigma}^*, q^*} [L^p(\boldsymbol{\sigma}^*, q^*, \dot{\gamma}^*)] \\ L^p(\boldsymbol{\sigma}, q, \dot{\gamma}) &:= -D^p(\boldsymbol{\sigma}, q) + \dot{\gamma} \phi_y(\boldsymbol{\sigma}, q) \end{aligned} \quad (17)$$

The associated Kuhn-Tucker optimality conditions will provide the corresponding evolution equation for internal variables:

$$\begin{aligned} 0 &= \frac{\partial L^p(\boldsymbol{\sigma}, q, \dot{\gamma})}{\partial \boldsymbol{\sigma}} = -\dot{\boldsymbol{\epsilon}}^p + \dot{\gamma} \frac{\partial \phi_y(\boldsymbol{\sigma}, q)}{\partial \boldsymbol{\sigma}}; \\ 0 &= \frac{\partial L^p(\boldsymbol{\sigma}, q, \dot{\gamma})}{\partial q} = -\dot{\zeta} + \dot{\gamma} \frac{\partial \phi_y(\boldsymbol{\sigma}, q)}{\partial q}; \\ \dot{\gamma} &\geq 0; \quad \phi_y(\boldsymbol{\sigma}, q) \leq 0; \quad \dot{\gamma} \phi_y(\boldsymbol{\sigma}, q) = 0 \end{aligned} \quad (18)$$

The corresponding value of each Lagrange multiplier $\dot{\gamma}$ for associative plasticity model is obtained from the consistency condition, which assures that in a plastic loading process, subsequent stress and deformation states remains on subsequent yield surface:

$$\begin{aligned} 0 &= \dot{\phi}_y = \frac{\partial \phi_y}{\partial \boldsymbol{\sigma}} \cdot \dot{\boldsymbol{\sigma}} + \frac{\partial \phi_y}{\partial q} \cdot \dot{q} \\ &= \frac{\partial \phi_y}{\partial \boldsymbol{\sigma}} \cdot \mathbf{C} \dot{\boldsymbol{\epsilon}} - G_y \dot{\gamma}; \end{aligned} \quad (19)$$

where

$$G_y = \frac{\partial \phi_y}{\partial \boldsymbol{\sigma}} \cdot \mathbf{C} \frac{\partial \phi_y}{\partial \boldsymbol{\sigma}} + \frac{\partial \phi_y}{\partial q} \cdot K \frac{\partial \phi_y}{\partial q} \quad (20)$$

Since $\dot{\gamma}$ is non-zero only when yield surface is active it follows that

$$0 = \dot{\phi}_y \Rightarrow \dot{\gamma} = G_y^{-1} \left(\frac{\partial \phi_y}{\partial \boldsymbol{\sigma}} \cdot \mathbf{C} \dot{\boldsymbol{\epsilon}} \right) \quad (21)$$

where G_{ij}^{-1} is the inverse of matrix G_{ij} . By using the last result we obtain the rate form of the stress-strain relations in (4)

$$\dot{\boldsymbol{\sigma}} = \mathbf{C}^{ep} \dot{\boldsymbol{\epsilon}} \quad (22)$$

where \mathbf{C}^{ep} are elastoplastic tangent moduli given by the expression

$$\mathbf{C}^{ep} = \begin{cases} \mathbf{C}; & \forall \dot{\gamma}_i = 0; \quad i = 1, 2, \dots, m \\ \mathbf{C} - G_y^{-1} \mathbf{C} \frac{\partial \phi_y}{\partial \boldsymbol{\sigma}} \otimes \mathbf{C} \frac{\partial \phi_y}{\partial \boldsymbol{\sigma}} \end{cases} \quad (23)$$

The consequences of the principle of maximum plastic dissipation characterizing such associative plasticity model is the convexity of the yield surface in stress space and normality of plastic flow with respect to the yield surface. Drucker's stability postulate is also in agreement with this principle. By changing the proposed flow rule with separate potential in (11) we can conclude that proposed model results with Drucker-Prager non-associative plasticity that is not stable in the sense of Drucker. However, stability postulate is sufficient but not a necessary criterion. Since the uniqueness of stress and strain trajectories for a given loading exists, the material can be regarded as locally stable, thus the condition of uniqueness rather than the stability postulate may be regarded as a basic for establishing stress-strain relationship. The non-associative flow rule for the

plastic strain rate tensor, using (11) and strain-like hardening variable, is given by

$$\begin{aligned} 0 &= -\dot{\epsilon}^p + \dot{\gamma} \frac{\partial \phi_p(\boldsymbol{\sigma}, q)}{\partial \boldsymbol{\sigma}} \\ 0 &= -\dot{\zeta} + \dot{\gamma} \frac{\partial \phi_y(\boldsymbol{\sigma}, q)}{\partial q} \end{aligned} \quad (24)$$

The loading/unloading conditions can be expressed in the Kuhn-Tucker form as

$$\dot{\gamma} \geq 0; \quad \phi_y(\boldsymbol{\sigma}, q) \leq 0; \quad \dot{\gamma} \phi_y = 0 \quad (25)$$

The plastic multiplier $\dot{\gamma}$ using the plastic consistency condition $\dot{\phi}_y = 0$ can be expressed in the form

$$\begin{aligned} 0 &= \dot{\phi}_y = \frac{\partial \phi_y}{\partial \boldsymbol{\sigma}} \cdot \dot{\boldsymbol{\sigma}} + \frac{\partial \phi_y}{\partial q} \cdot \dot{q} \\ &= \frac{\partial \phi_y}{\partial \boldsymbol{\sigma}} \cdot \mathbf{C} \dot{\boldsymbol{\epsilon}} - \dot{\gamma} \left(\frac{\partial \phi_y}{\partial \boldsymbol{\sigma}} \cdot \mathbf{C} \frac{\partial \phi_p}{\partial \boldsymbol{\sigma}} + \frac{\partial \phi_y}{\partial q} \cdot K \frac{\partial \phi_y}{\partial q} \right) \\ \Rightarrow \dot{\gamma} &= h^{-1} \frac{\partial \phi_y}{\partial \boldsymbol{\sigma}} \cdot \mathbf{C} \dot{\boldsymbol{\epsilon}} \end{aligned} \quad (26)$$

where we used relation

$$h^{-1} = \frac{\partial \phi_y}{\partial \boldsymbol{\sigma}} \cdot \mathbf{C} \frac{\partial \phi_p}{\partial \boldsymbol{\sigma}} + \frac{\partial \phi_y}{\partial q} \cdot K \frac{\partial \phi_y}{\partial q} \quad (27)$$

We can simplify corresponding results in (26) for proposed model to obtain:

$$\dot{\gamma} = \frac{2G\mathbf{v} : \dot{\boldsymbol{\epsilon}} + 3K\alpha_1 \text{tr}(\dot{\boldsymbol{\epsilon}})}{2G + 9K\alpha_1\alpha_2 + \frac{2}{3}K_h} \quad (28)$$

where

$$\begin{aligned} \mathbf{v} &= \frac{\text{dev}[\boldsymbol{\sigma}]}{\|\text{dev}[\boldsymbol{\sigma}]\|}; \quad \alpha_1 = \frac{1}{3}\tan\varphi; \quad \alpha_2 = \frac{1}{3}\tan\psi; \\ K_h &= \frac{dq(\zeta)}{d\zeta}; \\ q(\zeta) &= -(\sigma_\infty - \sigma_y)[1 - \exp(-\beta\zeta)] + K_{h,lin}\zeta; \end{aligned} \quad (29)$$

In (29) above, σ_y is initial uniaxial yield stress, β is the hardening parameter that governs the rate with which the saturation is achieved, σ_∞ is limit until the stress increase, $K_{h,lin}$ is hardening modulus.

Once the scalar function $\dot{\gamma}$ is determined the plastic strain increment from flow rule can be expressed as

$$\dot{\boldsymbol{\epsilon}}^p = \dot{\gamma} \frac{\partial \phi_p}{\partial \boldsymbol{\sigma}} = h^{-1} \underbrace{\frac{\partial \phi_y}{\partial \boldsymbol{\sigma}} \cdot \mathbf{C}}_{\mathbf{H}} \frac{\partial \phi_p}{\partial \boldsymbol{\sigma}} \dot{\boldsymbol{\epsilon}} \quad (30)$$

and corresponding stress increment can be determined from (4) and (7) combining with last expression

$$\begin{aligned} \dot{\boldsymbol{\sigma}} &= \mathbf{C} \left(\dot{\boldsymbol{\epsilon}} - \dot{\gamma} \frac{\partial \phi_p}{\partial \boldsymbol{\sigma}} \right) \\ &= \left(\mathbf{C} - h^{-1} \mathbf{C} \frac{\partial \phi_y}{\partial \boldsymbol{\sigma}} \otimes \mathbf{C} \frac{\partial \phi_p}{\partial \boldsymbol{\sigma}} \right) \dot{\boldsymbol{\epsilon}} \\ &= \mathbf{C}^{ep} \dot{\boldsymbol{\epsilon}} \end{aligned} \quad (31)$$

Thus the tangent elastoplastic tensor can be written in an additive format

$$\mathbf{C}^{ep} = \mathbf{C} + \mathbf{C}^p \quad (32)$$

with

$$\mathbf{C}^p = -h^{-1} \mathbf{C} \frac{\partial \phi_y}{\partial \boldsymbol{\sigma}} \otimes \mathbf{C} \frac{\partial \phi_p}{\partial \boldsymbol{\sigma}} = -h^{-1} \mathbf{H} \otimes \mathbf{H}^* \quad (33)$$

where \mathbf{C}^p is plastic tangent stiffness tensor and represents the degradation of the stiffness of material due to plastic flow. It can be noted from (33) that tensor \mathbf{C}^p lacks symmetry. The same holds for \mathbf{C}^{ep} with a non-associative flow rule is used as stated for chosen Drucker-Prager model:

$$\mathbf{C}^{ep} = \mathbf{C} - \frac{(2G\mathbf{v}_{n+1} + 3K\alpha_1\mathbf{1}) \otimes (2G\mathbf{v}_{n+1} + 3K\alpha_2\mathbf{1})}{2G + 9K\alpha_1\alpha_2 + \frac{2}{3}K_{h,iso}} \quad (34)$$

2.2. Hardening plasticity model in principal stress space

The stress update and formation of the elastoplastic tangent modulus requires the derivative of the yield function and the plastic potential function. Even for linear criteria, this is a cumbersome task when carried out in the general six-dimensional stress space. It will be shown in the following that computation in principal stress space simplifies procedure, presented in Section 2.1.. First, the dimension of the problem reduces from six to three, and second, in the three-dimensional stress space the stress states can be easily visualized graphically, making it possible to successfully apply geometric arguments. The approach is applicable to general isotropic yield criteria (e.g [27, 28, 29]), but in the following only Drucker-Prager criteria will be considered. As only isotropic material models are considered, the manipulations can be carried out with respect to any set of coordinates. Therefore the predictor stress is transformed into principal stress space, to compute the return to the yield surface. Considering the fact that the stress return preserves the principal directions, the updated stress can then be transformed back into the original Cartesian coordinates. The constitutive matrices are

also first formed in principal stress space and then subsequently transformed to standard coordinates.

The Drucker-Prager model in principal stress space is right-circular cone with its axis equally inclined with respect to each of the coordinate axes, and with its apex in the tension octant. It can be shown that plastic deformation must be accompanied by an increase in volume if $\varphi \neq 0$. This property known as dilatancy is consequences of the dependency of yield surface for associative or plastic potential surface for non-associative flow rule, on hydrostatic pressure. Figure 2 shows Drucker-Prager yield surface open in direction of the negative hydrostatic axis along with plastic potential function. From flow rule the plastic strain increment $d\epsilon_{ij}^p$ is perpendicular to plastic potential surface at the actual yield point M. The vector $d\epsilon_{ij}^p$ can be decomposed into vertical and horizontal component where horizontal components $d\epsilon_{ij}^{pv}$ represents the plastic volume change, which is always positive for $\psi > 0$ so and for associative plasticity. When using a negative dilatancy angle, we find that stress-strain curve gradually approaches a line with a negative slope. In other words, hardening is followed by softening leading to unstable behavior where the material resistance vanishes.

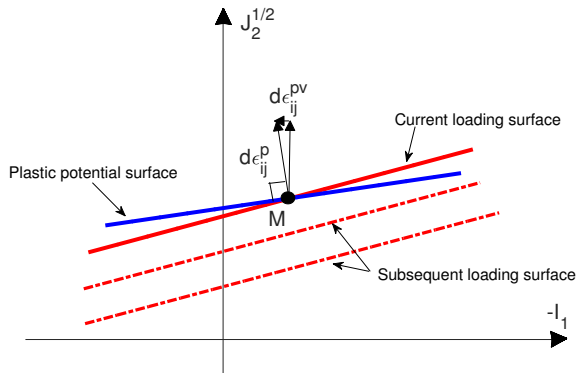

Figure 2: The loading and plastic potential surfaces for the Drucker-Prager material with a non-associated flow rule

Defining three main ingredients sufficient for the constitutive model of plasticity we can provide the stress tensor computation as well as internal variables evolution:

- additive decomposition of total strain into elastic and plastic component
 $\bar{\epsilon} = \bar{\epsilon}^e + \bar{\epsilon}^p$
- the free energy function constructed in terms of deformations
 $\psi(\bar{\epsilon}, \bar{\epsilon}^p, \bar{\zeta}) := \frac{1}{2}(\bar{\epsilon} - \bar{\epsilon}^p) \cdot \hat{C}(\bar{\epsilon} - \bar{\epsilon}^p) + \frac{1}{2}\bar{\zeta} K \bar{\zeta}$

- the yield criterion takes a very simple form in the principal axis representation

$$\phi_{y,s}(\bar{\sigma}, q) := \sqrt{J_2} + \frac{1}{3}\tan(\varphi)I_1 - \sqrt{\frac{2}{3}}(\sigma_y - q)$$

while plastic potential function is defined as

$$\phi_{p,s}(\bar{\sigma}, q) := \sqrt{J_2} + \frac{1}{3}\tan(\psi)I_1$$

where

$$J_2 = 1/6 [(\bar{\sigma}_1 - \bar{\sigma}_2)^2 + (\bar{\sigma}_2 - \bar{\sigma}_3)^2 + (\bar{\sigma}_3 - \bar{\sigma}_1)^2]$$

$$I_1 = \bar{\sigma}_1 + \bar{\sigma}_2 + \bar{\sigma}_3$$

is the second invariant of the deviatoric part of the Cauchy stress and the first invariant of the Cauchy stress, respectively.

The principal stresses and deformations as well as their directions are found by solving the eigenvalue problem

$$\begin{aligned} (\sigma - \bar{\sigma}_i \mathbf{I}) \mathbf{n}_i &= 0 \\ (\epsilon - \bar{\epsilon}_i \mathbf{I}) \mathbf{m}_i &= 0 \end{aligned} \quad (35)$$

where σ, ϵ are stress and deformation tensor, $\bar{\sigma}_i, \bar{\epsilon}_i$ are the eigenvalues, \mathbf{I} is identity matrix and $\mathbf{n}_i, \mathbf{m}_i$ are eigenvectors. The three eigenvectors of deformation tensor form a coordinate transformation tensor $Q_{i,j}$

$$\begin{aligned} Q_{i,j} &= \begin{bmatrix} n_{j,1} & n_{j,2} & n_{j,3} \end{bmatrix} = \\ &= \begin{bmatrix} \cos(x, \bar{x}) & \cos(y, \bar{x}) & \cos(z, \bar{x}) \\ \cos(x, \bar{y}) & \cos(y, \bar{y}) & \cos(z, \bar{y}) \\ \cos(x, \bar{z}) & \cos(y, \bar{z}) & \cos(z, \bar{z}) \end{bmatrix} = \begin{bmatrix} c_{x\bar{x}} & c_{y\bar{x}} & c_{z\bar{x}} \\ c_{x\bar{y}} & c_{y\bar{y}} & c_{z\bar{y}} \\ c_{x\bar{z}} & c_{y\bar{z}} & c_{z\bar{z}} \end{bmatrix} \end{aligned} \quad (36)$$

where the components are direction cosines between the two sets of axes. With the elements of $Q_{i,j}$ the transformation matrix can be written as:

$$T = \begin{bmatrix} c_{x\bar{x}}^2 & c_{y\bar{x}}^2 & c_{z\bar{x}}^2 \\ c_{x\bar{y}}^2 & c_{y\bar{y}}^2 & c_{z\bar{y}}^2 \\ c_{x\bar{z}}^2 & c_{y\bar{z}}^2 & c_{z\bar{z}}^2 \\ c_{x\bar{x}}c_{x\bar{y}} & c_{x\bar{y}}c_{x\bar{z}} & c_{x\bar{x}}c_{x\bar{z}} \\ c_{y\bar{x}}c_{y\bar{y}} & c_{y\bar{y}}c_{y\bar{z}} & c_{y\bar{x}}c_{y\bar{z}} \\ c_{z\bar{x}}c_{z\bar{y}} & c_{z\bar{y}}c_{z\bar{z}} & c_{z\bar{x}}c_{z\bar{z}} \end{bmatrix} \quad (37)$$

All the remaining ingredients of the plasticity model can be obtained from the standard thermodynamics considerations. Namely, the plastic strain rate tensor and strain-like hardening variable in principal direction, is given in same way as given in (24).

Using plastic consistency condition we can obtain plastic multiplier in same way as for computation in local coordinates and then update stress in the principal

stress space. Stress tensor in local coordinates can be obtained by using transformation matrix either using spectral decomposition of the principal stresses

$$\boldsymbol{\sigma} = \sum_{i=1}^3 \bar{\sigma}_i \mathbf{n}_i \otimes \mathbf{n}_i \rightarrow \boldsymbol{\sigma} = \mathbf{T} \bar{\boldsymbol{\sigma}} \quad (38)$$

After this computation, we also have to obtain the elastoplastic tangent modulus which consists of a material and of a geometric part

$$\begin{aligned} \mathbf{C} &= \frac{\partial \boldsymbol{\sigma}}{\partial \boldsymbol{\epsilon}} \\ &= \underbrace{\sum_{i=1}^3 \frac{\partial \bar{\sigma}_i}{\partial \boldsymbol{\epsilon}} \mathbf{n}_i \otimes \mathbf{n}_i}_{\mathbf{C}_{mat}} + \underbrace{\sum_{i=1}^3 \bar{\sigma}_i \frac{\partial}{\partial \boldsymbol{\epsilon}} (\mathbf{n}_i \otimes \mathbf{n}_i)}_{\mathbf{C}_{geo}} \end{aligned} \quad (39)$$

By applying the Gâteaux derivative formalism to the eigenvalue problem in (35) we obtain

$$\frac{\partial \bar{\sigma}_i}{\partial \boldsymbol{\epsilon}} = \mathbf{n}_i \otimes \mathbf{n}_i \quad (40)$$

By exploiting this results we can provide the closed form expression for the material part of elastoplastic tangent modulus in terms of its reduced form in principal axes D_{ij}^{ep} :

$$\begin{aligned} \mathbf{C}_{mat}^{ep} &= \sum_{i=1}^3 \frac{\partial \bar{\sigma}_i}{\partial \boldsymbol{\epsilon}} \mathbf{n}_i \otimes \mathbf{n}_i \\ &= \sum_{i=1}^3 \sum_{j=1}^3 \frac{\partial \bar{\sigma}_i}{\partial \bar{\epsilon}_j} \frac{\partial \bar{\epsilon}_j}{\partial \boldsymbol{\epsilon}} \mathbf{n}_i \otimes \mathbf{n}_i \\ &= \sum_{i=1}^3 \sum_{j=1}^3 D_{ij}^{ep} [\mathbf{n}_i \otimes \mathbf{n}_i] \otimes [\mathbf{n}_j \otimes \mathbf{n}_j] \end{aligned} \quad (41)$$

In particular, for an elastic step the elastoplastic tangent modulus in principal direction is the same as the elasticity tensor D_{ij} , while for a plastic step it is computed as the corresponding modification of elasticity tensor taking into account the final value of stress tensor for plastic step defined in (38):

$$D^{ep} = D - \frac{D \frac{\partial \phi_{y,s}}{\partial \boldsymbol{\sigma}} \otimes D \frac{\partial \phi_{p,s}}{\partial \boldsymbol{\sigma}}}{\frac{\partial \phi_{y,s}}{\partial \boldsymbol{\sigma}} \cdot D \frac{\partial \phi_{p,s}}{\partial \boldsymbol{\sigma}} + \frac{\partial \phi_{y,s}}{\partial q} \cdot K \frac{\partial \phi_{y,s}}{\partial q}} \quad (42)$$

In order to obtain geometric part of the tangent tensor we use fact that $\mathbf{n}_i \otimes \mathbf{n}_i$ can be obtained in closed form in terms of $\boldsymbol{\epsilon}$ which follows from Serrin's representation theorem. If all ϵ_i are distinct, then

$$\mathbf{n}_i \otimes \mathbf{n}_i = \frac{\epsilon_i}{d_i} \left[\boldsymbol{\epsilon} - (i_1 - \epsilon_i) \mathbf{I} + i_3 \epsilon_i^{-1} \boldsymbol{\epsilon}^{-1} \right] \quad (43)$$

if and only if $d_i \neq 0$ where $i_i; i=1,2,3$ are the principal invariants of deformation tensor and

$$d_i = (\epsilon_i - \epsilon_j)(\epsilon_i - \epsilon_k) \quad (44)$$

With this result in hand and using chain rule we can write the geometric part of tangent modulus as:

$$\begin{aligned} \mathbf{C}_{geo} &= \frac{\sigma_i}{d_i} \left[\mathbf{I} - \mathbf{1} \otimes \mathbf{1} - i_3 \epsilon_i^{-1} (\mathbf{I}_{\boldsymbol{\epsilon}^{-1}} - \boldsymbol{\epsilon}^{-1} \otimes \boldsymbol{\epsilon}^{-1}) + \mathbf{1} \otimes \mathbf{n}_i \right. \\ &\quad + \mathbf{n}_i \otimes \mathbf{1} - i_3 \epsilon_i^{-2} \times ((\mathbf{n}_i \otimes \mathbf{n}_i) \otimes \boldsymbol{\epsilon}^{-1} + \boldsymbol{\epsilon}^{-1} \otimes (\mathbf{n}_i \otimes \mathbf{n}_i)) \\ &\quad \left. + 2(i_3 \epsilon_i^{-3} - 1)(\mathbf{n}_i \otimes \mathbf{n}_i) \otimes (\mathbf{n}_i \otimes \mathbf{n}_i) \right] \end{aligned} \quad (45)$$

where

$$\mathbf{I}_{\boldsymbol{\epsilon}^{-1}}^{ABCD} = \frac{1}{2} (\boldsymbol{\epsilon}^{-1AC} \boldsymbol{\epsilon}^{-1BD} + \boldsymbol{\epsilon}^{-1AD} \boldsymbol{\epsilon}^{-1BC}) \quad (46)$$

In the case two or even all three principal deformation are the same, we can obtain similar expression (43) by using numerical perturbation of the identical values.

Finally, we can write the tangent tensor in matrix form using transformation matrix

$$\underbrace{\mathbf{C}^{ep}}_{6 \times 6} = \underbrace{\mathbf{T}}_{6 \times 3} \underbrace{\mathbf{C}_{mat}^{ep}}_{3 \times 3} \underbrace{\mathbf{T}^T}_{3 \times 6} + \underbrace{\mathbf{C}_{geo}}_{6 \times 6} \quad (47)$$

2.3. Softening plasticity in principal stress space

In this section, we present the theoretical formulation of the strong discontinuity approach for modeling the cracking of concrete. While in compression it can be observed three different deformation stages, linear elastic, nonlinear inelastic and localized stage in tension, elastic stage is followed by unstable softening stage. In order to take into account these two types of dissipative mechanisms we build multi-surface model in order to better reproduce the behavior of massive structures: a bulk dissipation characterized by the development of micro-cracks, which is taken into account by the introduction of Drucker-Prager model and a surface dissipation taking place at the level of the localization zones in terms of the macro-cracks triggered with St. Venant plasticity criterion in strain space defined by three surfaces.

$$\begin{aligned} \phi_1(\boldsymbol{\epsilon}^e) &= \epsilon_1^e - (\epsilon_y - q) \leq 0 \\ \phi_2(\boldsymbol{\epsilon}^e) &= \epsilon_2^e - (\epsilon_y - q) \leq 0 \\ \phi_3(\boldsymbol{\epsilon}^e) &= \epsilon_3^e - (\epsilon_y - q) \leq 0 \end{aligned} \quad (48)$$

One can also recover the standard format of the limit criterion in the stress space, which is more efficient in

numerical implementation, according to:

$$\begin{aligned}\phi_1(\boldsymbol{\sigma}) &= \frac{3K+G}{9KG}\sigma_1 - \frac{3K-2G}{18KG}(\sigma_2 + \sigma_3) - (\sigma_y - q) \leq 0 \\ \phi_2(\boldsymbol{\sigma}) &= \frac{3K+G}{9KG}\sigma_2 - \frac{3K-2G}{18KG}(\sigma_1 + \sigma_3) - (\sigma_y - q) \leq 0 \\ \phi_3(\boldsymbol{\sigma}) &= \frac{3K+G}{9KG}\sigma_3 - \frac{3K-2G}{18KG}(\sigma_1 + \sigma_2) - (\sigma_y - q) \leq 0\end{aligned}\quad (49)$$

where we have chosen the reference value of the elasticity limit obtained from hydrostatic tension test.

Figure 3 present the principal axis representation of this three dimensional criterion. The three surfaces are therefore simply represented by planes in 3D or straight lines in 2D case. We should note that $\Phi_1 \geq \Phi_2 \geq \Phi_3$, so that the second and third surface can never be the only one active, for 2D case the second surface is the one which can never be the only one active (see Figure 3.b). In pure tension mode, the limit of the elastic domain is,

$$\phi_1(\sigma_2) = \frac{3K+G}{9KG}\sigma_1 - \sigma_y \leq 0 \quad (50)$$

and, in pure compression:

$$\phi_1(\sigma_1) = \frac{3K-2G}{18KG}\sigma_2 - \sigma_y \leq 0 \quad (51)$$

where we have chosen the reference value of the elasticity limit obtained from hydrostatic tension test.

In order to provide reliable predictive model for concrete taking into account two types of dissipative mechanisms, we combine this multi-surface model in order to represent localized failure. The fracture process zone is still represented with non-associative Drucker-Prager model. Figure 1.a shows a graphic illustration of the proposed criterion in principal axes of stress tensor. One can note that in tension region elastic stage is followed by softening, while in compression not only the ductile part with fracture process zone is larger, but also its

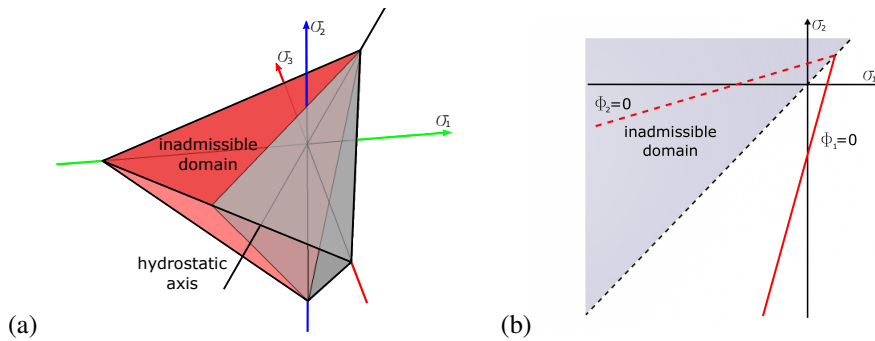

Figure 3: Elastic domain in principal stress space (a) 3D case (b) 2D case for $\sigma_3 = 0$

contribution to total dissipation for compression failure. Figure 1.b clearly reveals that the only special load case which is not limited, is a three-axial compression that can be produced by hydrostatic pressure.

In order to provide the appropriate interpretation of the localized plastic deformation, we consider a domain Ω split into two sub-domains Ω^+ and Ω^- by a surface of discontinuity, denoted as Γ_s , see Figure 4. The total displacement field \mathbf{u} is written as the sum of a smooth regular part $\bar{\mathbf{u}}$ and the displacement discontinuity $\bar{\mathbf{u}}$, centered at the Γ_s . The surface of discontinuity Γ_s is characterized at each point by a unit vector of exterior normal denoted as \mathbf{n} , a tangential vector denoted as \mathbf{m} and binormal vector \mathbf{b} . The discontinuous displacement field can then be written as

$$\begin{aligned}\mathbf{u}(\mathbf{x}, t) &= \bar{\mathbf{u}}(\mathbf{x}, t) + \bar{\mathbf{u}}(\mathbf{x}, t)M_{\Gamma_s}(\mathbf{x}) \\ M_{\Gamma_s}(\mathbf{x}) &= H_{\Gamma_s}(\mathbf{x}) - N_{\bar{\Omega}}(\mathbf{x})\end{aligned}\quad (52)$$

where $H_{\Gamma_s}(\mathbf{x})$ is the Heaviside function being equal to 1 in Ω^+ and to 0 in Ω^- , whereas $N_{\bar{\Omega}}(\mathbf{x})$ is continuous function which can be sketched arbitrary except for satisfying following two conditions:

$$N_{\bar{\Omega}}(\mathbf{x}) = \begin{cases} 1; & \mathbf{x} \in \Omega^+ \\ 0; & \mathbf{x} \in \Omega^- \end{cases}$$

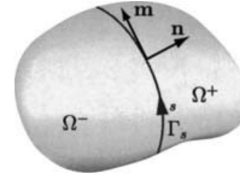

Figure 4: Slip line Γ_s separating domain into Ω^+ and Ω^-

By combining the Newton third law which imposes the continuity of traction across displacement disconti-

nuity line Γ_s and the Cauchy principle, we can write:

$$\mathbf{0} = \dot{\mathbf{t}} = \boldsymbol{\sigma} \dot{\mathbf{n}} + \underbrace{\boldsymbol{\sigma}}_{=0} \dot{\mathbf{n}} \quad (53)$$

where the second term drops out because it is assumed that the direction of the discontinuity remains fixed in time.

Furthermore, by using last results with assumption that the bifurcation phenomena in an elastoplastic response can be interpolated as the difference between two smooth stress fields, defining the corresponding jump in the stress rate, we obtain:

$$\begin{aligned} 0 &= \mathbf{C}^{ep}(\mathbf{m} \otimes \mathbf{n} \dot{\alpha}) \\ &= \mathbf{A}^{ep} \dot{\mathbf{m}} \dot{\alpha}; \quad \mathbf{A}^{ep} = \mathbf{n} \mathbf{C}^{ep} \mathbf{n} \end{aligned} \quad (54)$$

where \mathbf{A}^{ep} is the acoustic tensor. Herein, we assume that the critical mode \mathbf{m} is parallel to a normal vector \mathbf{n} providing mode I as a opening mode in tension.

The corresponding deformation field that is produced by such a displacement field can be written as

$$\begin{aligned} \boldsymbol{\epsilon}(\mathbf{x}, t) &= \underbrace{\nabla^s \bar{\mathbf{u}}(\mathbf{x}, t) + \bar{\mathbf{G}}(\mathbf{x}) \bar{\mathbf{u}}(t)}_{\bar{\boldsymbol{\epsilon}}} + (\bar{\mathbf{u}}(t) \otimes \mathbf{n})^s \delta_{\Gamma}(\mathbf{x}) \\ \bar{\mathbf{G}}(\mathbf{x}) &= -\nabla^s N_{\bar{\Omega}}(\mathbf{x}) \end{aligned} \quad (55)$$

The strain field appears then to be decomposed into a regular part and a singular part, the latter accompanying the Dirac-delta function $\delta_{\Gamma}(\mathbf{x})$. The strain energy in this case can be written:

$$\psi(\boldsymbol{\epsilon}, \bar{\zeta}, \bar{\zeta}) := \underbrace{\psi^e(\boldsymbol{\epsilon}^e)}_{regular} + \bar{\Xi}(\bar{\zeta}) + \bar{\Xi}(\bar{\zeta}) \delta_{\Gamma_s} \quad (56)$$

where the first term is the elastic energy, whereas the second and the third terms are the contributions of hardening and softening mechanisms, respectively. The total plastic dissipation can be expressed as the sum of the dissipation from fracture process zone in $\bar{\Omega}$ and from the discontinuity on Γ_s , which can be written:

$$\begin{aligned} 0 \leq D_{\bar{\Omega}}^p &= \int_{\bar{\Omega}} [\boldsymbol{\sigma} \cdot \dot{\boldsymbol{\epsilon}} - \dot{\psi}(\boldsymbol{\epsilon}, \bar{\zeta}, \bar{\zeta})] dV \\ &= \int_{\bar{\Omega}} [\boldsymbol{\sigma} \cdot \dot{\boldsymbol{\epsilon}} - (\dot{\psi}^e(\boldsymbol{\epsilon}^e) + \dot{\Xi}(\bar{\zeta}))] dV \\ &+ \int_{\Gamma_s} [\mathbf{t} \cdot \mathbf{m}] \dot{\alpha} dA - \int_{\Gamma_s} \dot{\Xi}(\bar{\zeta}) dA \end{aligned} \quad (57)$$

From results above we can then obtain the additive decomposition of the total plastic dissipation into a regular and a singular part:

$$D_{\bar{\Omega}}^p = \int_{\bar{\Omega}} (\boldsymbol{\sigma} \cdot \dot{\boldsymbol{\epsilon}}^p + \dot{q} \dot{\bar{\zeta}}) dV + \int_{\Gamma_s} \dot{q} \dot{\bar{\zeta}} dA \quad (58)$$

For the last result to be valid we assume that the following stress orthogonality condition must be satisfied:

$$\int_{\bar{\Omega}} \boldsymbol{\sigma} \cdot \bar{\mathbf{G}} \mathbf{m} \dot{\alpha} dV + \int_{\Gamma_s} (\mathbf{t} \cdot \mathbf{m}) \dot{\alpha} dA = 0 \quad (59)$$

The yield condition controlling inelastic deformation at discontinuity is set directly in terms of the traction vector component $t_m = \mathbf{t} \cdot \mathbf{m}$ ($\leftarrow \mathbf{m} = \mathbf{n}$):

$$\bar{\Phi}(t_m, \bar{q}) = \underbrace{|\mathbf{t} \cdot \mathbf{m}|}_{t_m} - (\sigma_y - \bar{q}) \quad (60)$$

Here, σ_y is a failure threshold and \bar{q} is the internal plasticity variable for evolution of softening. When the softening constitutive law is chosen to be exponential, the internal variable for plasticity can be written as:

$$\bar{q} = \sigma_y \left(1 - \exp\left(-\bar{\zeta} \frac{\sigma_y}{G_f}\right) \right) \quad (61)$$

where G_f is the corresponding value of fracture energy. Since the compressive and the tension failure mechanisms are reproduced according to the same fracture mode driven by the principal tensile strains, the corresponding amount of fracture energy can be quite different because of the number of cracks created in those two cases. This is illustrated in Figure 5.a representing the crack pattern in simple tension and the one in simple compression test, leading to quite different dissipated energy. Here, we indicate that the fracture energy is supposed to change continuously from a specified value in tension G_t to compression G_c (Figure 5.b) according to:

$$G_f = \frac{G_c + G_t}{2} - \frac{G_c - G_t}{2} \tanh(\beta \text{tr}[\boldsymbol{\epsilon}]) \quad (62)$$

where β is a parameter to be chosen to set a more or less rapid transition.

Assuming further that the plastic multiplier takes the form $\dot{\gamma} = \dot{\gamma} + \dot{\gamma} \delta_{\Gamma_s}$, we can make use of the principle of maximum plastic dissipation with

$$\begin{aligned} \bar{L}^p(\boldsymbol{\sigma}, \bar{q}, \dot{\gamma}) &= \max_{\dot{\gamma} \geq 0} \min_{\forall (t^*, \bar{q}^*)} \left[\bar{L}^p(\boldsymbol{\sigma}^*, \bar{q}^*, \dot{\gamma}^*) \right] \\ &= -D_{\bar{\Omega}}^{loc}(\cdot) + \int_{\bar{\Omega}} \dot{\gamma} \bar{\Phi} dV + \int_{\Gamma_s} \dot{\gamma} \bar{\Phi} dA \end{aligned} \quad (63)$$

The Kuhn-Tucker optimality condition will provide the corresponding evolution equation for internal variables:

$$\begin{aligned} 0 &= \int_{\bar{\Omega}} \left(-\dot{\boldsymbol{\epsilon}}^p + \dot{\gamma} \frac{\partial \bar{\Phi}}{\partial \boldsymbol{\sigma}} \right) dV; \\ 0 &= \int_{\bar{\Omega}} \left(-\dot{\zeta}^p + \dot{\gamma} \frac{\partial \bar{\Phi}}{\partial \bar{q}} \right) dV; \end{aligned} \quad (64)$$

accompanied with

$$0 = \int_{\Gamma_s} \left(-\dot{\zeta} + \dot{\gamma} \frac{\partial \bar{\phi}}{\partial \bar{q}} \right) dA \Rightarrow \int_{\Gamma_s} \dot{\zeta} dA = \int_{\Gamma_s} \dot{\gamma} dA \quad (65)$$

The plastic multiplier can be computed from plastic consistency condition enforcing that $\bar{\Phi} = 0$, which results with:

$$\dot{\gamma} = \frac{1}{\bar{K}} \int_{\Omega} \dot{\sigma} \bar{\mathbf{G}} dV \quad (66)$$

3. Space and time discrete approximation

In this section we will present the main steps in applying the implicit backward Euler scheme to 3D plasticity model for concrete materials.

3.1. Spatial discretization

We first elaborate upon the solution of the initial boundary value problem, posed by the weak form of the equilibrium equations (3) and the evolution equations (24). We use standard semi-discretization procedure to construct the finite-element-based displacement approximation over a single element Ω^e

$$\mathbf{u}(\mathbf{x}, t)|_{\Omega^e} = \sum_{a=1}^{n_{en}} \mathbf{N}_a^e(\mathbf{x}) \mathbf{u}_a(t) \quad (67)$$

where ‘ n_{en} ’ is the total number of element nodes, $\mathbf{N}_a^e(\mathbf{x})$ are the finite element shape functions and $\mathbf{u}_a(t)$ are the nodal displacements. Upon replacing this approximation into the weak form of the equilibrium equations in (3) we can integrate with respect to the space variables \mathbf{x} , thus reducing the current problem to tracing the pseudo-time history of the state variables. In other words, the weak form of equilibrium equations can be written as

$$G = \sum_{e=1}^{n_{el}} \left\{ \int_{\Omega^e} \mathbf{B}_a^{eT}(\mathbf{x}) \boldsymbol{\sigma}(\boldsymbol{\epsilon}(\mathbf{x}, t), \boldsymbol{\epsilon}^p(\mathbf{x}, t), \zeta(\boldsymbol{\xi}, t)) dV - \int_{\Omega^e} \mathbf{N}_a^e(\mathbf{x}) \cdot \mathbf{b}(\mathbf{x}, t) dV - \int_{\Gamma_\sigma} \mathbf{N}_a^e(\mathbf{x}) \cdot \mathbf{t}(\mathbf{x}, t) dA \right\} = \mathbf{0} \quad (68)$$

where $\sum_{e=1}^{n_{el}}$ denotes the standard finite element assembly procedure over the total number of elements n_{el} .

By choosing the Gauss quadrature rule with n_{in} points, with abscissas $\boldsymbol{\xi}_l$ and integration points w_l we can rewrite equilibrium equations as

$$G = \sum_{e=1}^{n_{el}} \left\{ \sum_{l=1}^{n_{in}} (w_l \mathbf{B}_a^{eT}(\boldsymbol{\xi}_l) \boldsymbol{\sigma}(\boldsymbol{\epsilon}(\boldsymbol{\xi}_l, t), \boldsymbol{\epsilon}^p(\boldsymbol{\xi}_l, t), \zeta(\boldsymbol{\xi}_l, t))) j(\boldsymbol{\xi}_l) - w_l \mathbf{N}_a^e(\boldsymbol{\xi}_l) \cdot \mathbf{b}(\boldsymbol{\xi}_l, t) j(\boldsymbol{\xi}_l) - \sum_{l=1}^{n_{in}} w_l \mathbf{N}_a^e(\boldsymbol{\xi}_l) \cdot \mathbf{t}(\boldsymbol{\xi}_l, t) \right\} = \mathbf{0} \quad (69)$$

The numerical integration introduces a crucial simplification concerning the internal state variable computation, in that their values need to be obtained only at the integration points. The computed values of internal variables, obtained for a particular value of pseudo-time, are then stored at each integration point for subsequent use. The corresponding values of the total strains at a numerical integration point $\boldsymbol{\xi}_l$ can be simply recovered from the chosen displacement approximation as

$$\boldsymbol{\epsilon}(\boldsymbol{\xi}_l, t) = \mathbf{B}_a^e(\boldsymbol{\xi}_l) \mathbf{u}^e(t) \quad (70)$$

3.2. Integration of internal state variables for plasticity

As the result of using the semi-discretization procedure, the evolution equations (18) become the ordinary differential equations in time. Integrating those equations in the time interval of interest, $[0; T]$, we can trace the evolution of the internal state variables. This integration is carried out numerically by using the unconditionally stable backward Euler time integration scheme. The solution is thus obtained for the chosen values of pseudo-time in the incremental sequence: $0 < t_1 < t_2 < \dots < t_n < t_{n+1} < \dots < T$. Considering that the backward Euler is one-step integration scheme, it only remains to elaborate upon the solution procedure over a typical time increment. To that end, let

$$\boldsymbol{\epsilon}_n = \boldsymbol{\epsilon}(t_n); \quad \boldsymbol{\epsilon}_n^p = \boldsymbol{\epsilon}^p(t_n); \quad \zeta_n = \zeta(t_n); \quad (71)$$

be given data at time t_n , and $\Delta t = t_{n+1} - t_n$ the given time increment. The problem is to obtain the corresponding values of the state variables at time t_{n+1} ,

$$\boldsymbol{\epsilon}_{n+1}; \quad \boldsymbol{\epsilon}_{n+1}^p; \quad \zeta_{n+1}; \quad (72)$$

which are admissible in the sense that the yield criterion is satisfied.

Tackling this problem in the spirit of the operator split method, we assume to be given the total strain increment $\Delta \boldsymbol{\epsilon}_{n+1}^{(k)}$ which corresponds to the best iterative guess of the displacement value $\mathbf{u}^{(k)}$, with k being the iteration counter. The first part of the computation reduces to a simple additive update of the total deformation field

$$\boldsymbol{\epsilon}_{n+1}^{(k)} = \boldsymbol{\epsilon}_n + \Delta \boldsymbol{\epsilon}_{n+1}^{(k)} \quad (73)$$

The computation of the remaining state variables is carried out by applying the backward Euler method to the evolution equations (24) leading to following sys-

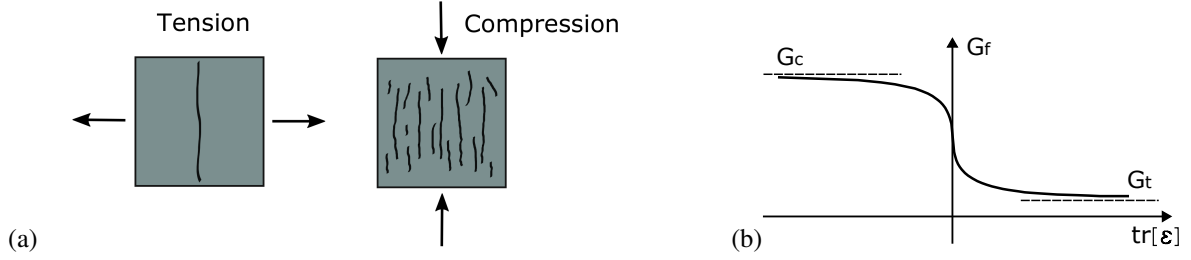

Figure 5: (a) Failure modes in both compression and tension (b) Influence of strain state on fracture energy

tem:

$$\begin{aligned}
\boldsymbol{\epsilon}_{n+1}^p &= \boldsymbol{\epsilon}_n^p + \gamma_{n+1}(\mathbf{v}_{n+1} + \alpha_2 \mathbf{1}) \\
\zeta_{n+1} &= \zeta_n + \gamma_{n+1} \sqrt{\frac{2}{3}} \\
\boldsymbol{\sigma}_{n+1} &= \mathbf{C}(\boldsymbol{\epsilon}_{n+1} - \boldsymbol{\epsilon}_{n+1}^p) \\
q_{n+1} &= -K\zeta_{n+1}
\end{aligned} \tag{74}$$

In addition, the discrete counterpart of Kuhn-Tucker conditions becomes:

$$\begin{aligned}
\phi_y(\boldsymbol{\sigma}_{n+1}, q_{n+1}) &\leq 0 \\
\gamma_{i,n+1} &\geq 0 \\
\gamma_{n+1}\phi_y(\boldsymbol{\sigma}_{n+1}, q_{n+1}) &= 0
\end{aligned} \tag{75}$$

However, since the correct value of plastic multiplier $\hat{\gamma}_{n+1} \geq 0$ is not known a priori, we proceed with the elastic trial test. Namely, we start by assuming that the step remains elastic and setting $\hat{\gamma}_{n+1}^{trial} = 0$, which results with the corresponding trial values of the internal variables

$$\boldsymbol{\epsilon}_{n+1}^{p,trial} = \boldsymbol{\epsilon}_n^p, \quad \zeta_{n+1}^{trial} = \zeta_n; \tag{76}$$

We can thus readily compute the trial values of stress

$$\begin{aligned}
\boldsymbol{\sigma}_{n+1}^{trial} &= \mathbf{C}(\boldsymbol{\epsilon}_{n+1} - \boldsymbol{\epsilon}_n^p); \\
\bar{q}_{n+1}^{trial} &= \bar{q}_n = -K\zeta_n; \\
\phi_{y,n+1}^{trial} &= \phi_y(\boldsymbol{\sigma}_{n+1}^{trial}, \bar{q}_{n+1}^{trial})
\end{aligned} \tag{77}$$

If the trial value of yield functions is indeed not positive, the trial state is accepted for final, and the internal variables will not change their values with respect to the previous step.

$$\begin{aligned}
0 &\geq \phi_{y,n+1}^{trial}(\boldsymbol{\sigma}_{n+1}^{trial}, \bar{q}_{n+1}^{trial}) := \|dev[\boldsymbol{\sigma}_{n+1}^{trial}]\| \\
&+ \frac{1}{3} \tan(\alpha) \text{tr}[\boldsymbol{\sigma}_{n+1}^{trial}] - \sqrt{\frac{2}{3}}(\sigma_y - \bar{q}_{n+1}^{trial}) \\
\boldsymbol{\epsilon}_{n+1}^p &= \boldsymbol{\epsilon}_n^p; \quad \zeta_{n+1} = \zeta_n
\end{aligned} \tag{78}$$

In the opposite case producing a positive trial value of yield function $\phi_{n+1}^{trial} > 0$, we know that the step is plastic

in fact. Thus we have to find the true (positive) value of plastic multiplier $\gamma_{n+1} > 0$, which will reestablish the plastic admissibility of stress with $\phi_{n+1} = 0$. The corresponding value of the plastic multiplier is obtained from the consistency condition taking into account non-associative flow rule to obtain:

$$\gamma_{n+1} = \frac{\phi_{y,n+1}^{trial}}{2G + 9K\alpha_1\alpha_2 + \frac{2}{3}K_{h,lin}} \tag{79}$$

This value of plastic multiplier will also provide the corresponding new values of plastic deformation, hardening variable and the corresponding stress:

$$\boldsymbol{\sigma}_{n+1} = \boldsymbol{\sigma}_{n+1}^{trial} - \gamma_{n+1}\mathbf{C}(\mathbf{v}_{n+1} + \alpha_2 \mathbf{1}) \tag{80}$$

After the convergence of this computation, we also have to obtain the consistent elastoplastic tangent modulus, which can be written:

$$\begin{aligned}
\mathbf{C}^{ep} &= \mathbf{C} - \frac{(2G\mathbf{v}_{n+1} + 3K\alpha_1 \mathbf{1}) \otimes (2G\mathbf{v}_{n+1} + 3K\alpha_2 \mathbf{1})}{2G + 9K\alpha_1\alpha_2 + \frac{2}{3}K_{h,iso}} \\
&- \frac{4G^2}{\|dev[\boldsymbol{\sigma}_{n+1}^{trial}]\|} \left[\mathcal{I} - \mathbf{v}_{n+1} \otimes \mathbf{v}_{n+1} - \frac{1}{3}\mathbf{1} \otimes \mathbf{1} \right]
\end{aligned} \tag{81}$$

We note in passing that the consistent elastoplastic tangent modulus given above is different from the corresponding one valid for the continuum problem in (34). The difference between the consistent and continuum tangent moduli concerns the third term in (81) above, which is due to the change of normal to the yield surface over a time step. Equivalent computations are carried out in strain softening phase, which is started once the localization condition in (54) happens to be verified for one of the quadrature points. One can thus obtain that:

$$\begin{aligned}
\bar{\Phi}(\bar{\gamma}_{n+1}) &= 0; \quad t_{m,n+1} = t_y - \bar{q}(\bar{\zeta}_{n+1}) \\
\bar{K} &= -\frac{d\bar{q}}{d\bar{\zeta}_{n+1}}
\end{aligned} \tag{82}$$

The finite element interpolation is chosen to take into account a displacement discontinuity, by considering the incompatible mode methods. More precisely, we choose the finite element interpolation according to:

$$\mathbf{u}^h(\mathbf{x}, t) = \mathbf{N}(\mathbf{x})\mathbf{u}_a + \boldsymbol{\alpha}(t)\mathbf{M}(\mathbf{x}) \quad (83)$$

where $\mathbf{N}(\mathbf{x})$ is the classical shape function associated to the considered brick element, \mathbf{u}_a denotes the nodal displacement and $\mathbf{M}(\mathbf{x})$ is a discontinuous interpolation function. The discontinuity can be introduced by splitting the 8-node brick in such a way that a pair of nodes is placed at each side of the discontinuity. If Ω^+ denotes the part of the element on one side of the opening surface, we can thus write:

$$\mathbf{M}(\mathbf{x}) = H_{\Gamma_s}(\mathbf{x}) - \sum_{b \in \Omega^+} \mathbf{N}_b(\mathbf{x}) \quad (84)$$

With such an approximation, the finite element interpolation of the strain field can be written as:

$$\boldsymbol{\epsilon}^h(\mathbf{x}, t) = \mathbf{B}(\mathbf{x})\mathbf{u}_a + \boldsymbol{\alpha}(t)\mathbf{G}_r(\mathbf{x}) \quad (85)$$

where $\mathbf{G}_r(\mathbf{x}) = \mathbf{L}\mathbf{M}(\mathbf{x})$ with \mathbf{L} the matrix associated to the operator ∇^s . The finite element interpolation of the virtual strain field can be constructed with the same scheme as

$$\delta\boldsymbol{\epsilon}^h(\mathbf{x}, t) = \mathbf{B}(\mathbf{x})\delta\mathbf{u}_a + \delta\boldsymbol{\alpha}(t)\mathbf{G}_v(\mathbf{x}) \quad (86)$$

where $\delta\mathbf{u}_a$ and $\delta\boldsymbol{\alpha}(t)$ denote, respectively, the virtual displacement field and virtual displacement jump field. $\mathbf{G}_v(\mathbf{x})$ is a modified incompatible mode function constructed from the function $\mathbf{G}_r(\mathbf{x})$ so as to guarantee the satisfaction of the patch-test. We note that in general $\mathbf{G}_v(\mathbf{x})$ is different from the function $\mathbf{G}_r(\mathbf{x})$. It has to be noted that, as $\mathbf{M}(\mathbf{x})$ is a discontinuous function, the functions $\mathbf{G}_r(\mathbf{x})$ and $\mathbf{G}_v(\mathbf{x})$ can be decomposed into a regular and a singular part as

$$\begin{aligned} \mathbf{G}_r(\mathbf{x}) &= \bar{\mathbf{G}}_r(\mathbf{x}) + \bar{\bar{\mathbf{G}}}_r(\mathbf{x})\delta_{\Gamma_s} \\ \mathbf{G}_v(\mathbf{x}) &= \bar{\mathbf{G}}_v(\mathbf{x}) + \bar{\bar{\mathbf{G}}}_v(\mathbf{x})\delta_{\Gamma_s} \end{aligned} \quad (87)$$

With those interpolations for real and virtual strain fields using the incompatible mode, the discretized problem can be written as

$$\begin{aligned} A_{e=1}^{n_{el}} (\mathbf{f}^{int,(e)} - \mathbf{f}^{ext}) &= 0; \quad \mathbf{f}^{int,(e)} = \int_{\Omega^e} \mathbf{B}^T \cdot \boldsymbol{\sigma}_{n+1} dV \\ \mathbf{h}_{n+1}^{(e)} &= \int_{\Omega^e} \bar{\mathbf{G}}_v^T(\mathbf{x}) \cdot \boldsymbol{\sigma}_{n+1} dV + \int_{\Gamma_s} t_{m,n+1} dA; \quad \forall e \in [1, n_{el}] \end{aligned} \quad (88)$$

The weak form of equilibrium is written as a system of two equations. The first one is the set of global equilibrium equations, which is classically written in the finite element method. The second one is a local equilibrium equation written in each localized element. Independently this equation can be interpreted as the weak form of the traction continuity condition along the surface of discontinuity. The consistent linearization of system (89) leads to the set of equilibrium equations, which can be written for time step $n + 1$ and iteration (i):

$$\begin{aligned} A_{e=1}^{n_{el}} [\mathbf{K}_{n+1}^{e,(i)} \Delta \mathbf{u}_{n+1}^{(i)} + \mathbf{F}_{n+1}^{e,(i)} \Delta \boldsymbol{\alpha}_{n+1}^{(i)}] &= A_{e=1}^{n_{el}} [\mathbf{f}_{n+1}^{ext,e} - \mathbf{f}_{n+1}^{int,e,(i)}] \\ \mathbf{h}_{n+1}^{e,(i)} + (\mathbf{F}_{v,n+1}^{e,(i)} + \mathbf{K}_{d,n+1}^{(i)}) \Delta \mathbf{u}_{n+1}^{(i)} &+ \\ (\mathbf{H}_{n+1}^{e,(i)} + \mathbf{K}_{\alpha,n+1}^{(i)}) \Delta \boldsymbol{\alpha}_{n+1}^{(i)} &= 0 \end{aligned} \quad (89)$$

where:

$$\begin{aligned} \mathbf{K}_{n+1}^{e,(i)} &= \int_{\Omega^e} \mathbf{B}^T \mathbf{C}_{n+1}^{ep,(i)} \mathbf{B} dV, \quad \mathbf{F}_{n+1}^{e,(i)} = \int_{\Omega^e} \mathbf{B}^T \mathbf{C}_{n+1}^{ep,(i)} \bar{\mathbf{G}}_m dV \\ \mathbf{F}_{v,n+1}^{e,(i)} &= \int_{\Omega^e} \mathbf{m}^T \bar{\mathbf{G}}^T \mathbf{C}_{n+1}^{ep,(i)} \mathbf{B} dV, \\ \mathbf{H}_{n+1}^{e,(i)} &= \int_{\Omega^e} \mathbf{m}^T \bar{\mathbf{G}}^T \mathbf{C}_{n+1}^{ep,(i)} \bar{\mathbf{G}}_m^T dV \\ \mathbf{K}_{d,n+1}^{e,(i)} &= A_{\Gamma_s^e} \frac{\partial t_m}{\partial u} |_{n+1}^{(i)}, \quad \mathbf{K}_{\alpha,n+1}^{e,(i)} = A_{\Gamma_s^e} \frac{\partial t_m}{\partial \alpha} |_{n+1}^{(i)} \end{aligned} \quad (90)$$

At that stage there are a couple of possibilities to solve the above set of equilibrium equations. The first possibility consists in solving simultaneously at global level the two equations. The second possibility, which is chosen herein, consists in taking advantage of the fact that the second equation is written locally in each localized element. Then, this second equation is solved at the element level for a given value of the displacement field increment $\Delta \mathbf{u}_{n+1}^{(i)}$. This allows determining the value of the displacement jump increment $\Delta \boldsymbol{\alpha}_{n+1}^{(i)}$. Then by static condensation at the element level, the system of equations in (90) is reduced to a single equation which takes the classical form in the finite element method as:

$$\begin{aligned} A_{e=1}^{n_{el}} \widehat{\mathbf{K}}_{n+1}^e \Delta \mathbf{u}_{n+1}^{(i)} &= A_{e=1}^{n_{el}} [\mathbf{f}_{n+1}^{ext,e} - \mathbf{f}_{n+1}^{int,e,(i)}] \quad \text{with} \\ \widehat{\mathbf{K}}_{n+1}^{e,(i)} &= \mathbf{K}_{n+1}^{e,(i)} - \mathbf{F}_{n+1}^{e,(i),T} (\mathbf{H}_{n+1}^{e,(i)} + \mathbf{K}_{\alpha,n+1}^{(i)})^{-1} (\mathbf{F}_{v,n+1}^{e,(i)} + \mathbf{K}_{d,n+1}^{(i)}) \end{aligned} \quad (91)$$

4. Numerical examples

In this section we present the numerical simulations and computed macroscopic responses for a number of different concrete specimens and various loading conditions illustrating the ability of the proposed procedure to describe the behavior till complete failure. The computations are performed by a research version of computer program FEAP, developed by R.L. Taylor at UC Berkeley [30]

4.1. Uniaxial tension test

We consider here the specimen given as a cube with 15 cm side length. The material parameters adopted are shown in Table 1. These computations (and subsequent ones) are made under the displacement control with unrestrained lateral displacements for tension test.

K	15 GPa
G	15 GPa
σ_u	6.5 MPa
$G_{f,t}$	0.5 N/mm

Table 1: Material parameters

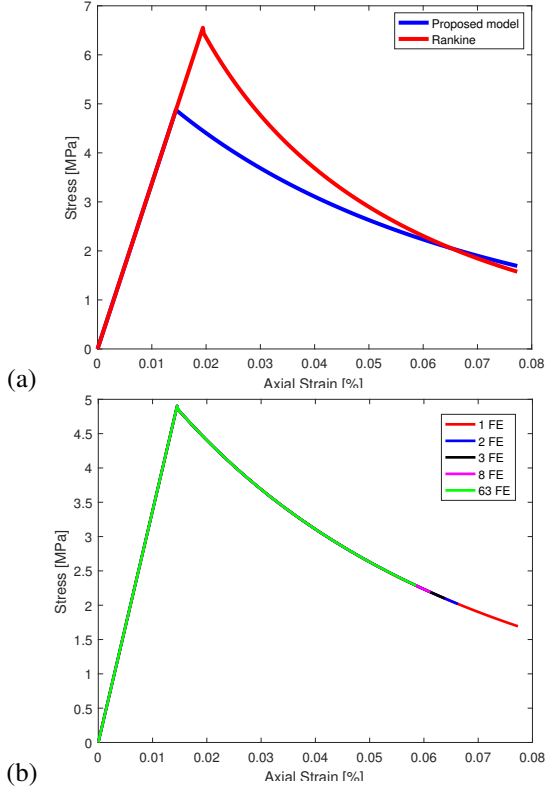

Figure 6: Macroscopic response for uniaxial tension test

In order to avoid the ambiguity of the failure pattern under homogeneous stress field in the solid elements, the slight imperfection is introduced into only one element. This allows to avoid the academic case when the uniform load is applied to a series of homogeneous solid elements resulting in localized failure in different

elements at the same time, or only decided by numerical round-off errors.

Figure 6.a shows macroscopic stress (sum of all reactions in vertical direction divided by cross-section area of the concrete cube) with respect to strain. Limit stress which triggers the global softening obtained with proposed model is lower than the limit stress obtained with Rankine criterion with the same parameters. Namely, the limit stress for proposed model is chosen to correspond to elasticity limit in hydrostatic tension test. Thus, for uniaxial and biaxial loading we can note from (50) that this limit is lower compared to the limit stress obtained with Rankine type of failure (Figure 2). We can note from Figure 6.b that the model gives the mesh independent results when the imperfection is added to one of the solid finite elements and the exponential softening drives the solid to complete failure.

Moreover, we can see from Figure 7 that all displacements plotted at the end of computation are localized in zone where we placed element with slight imperfection and where final failure surface is formed.

4.2. Notched bar in tension

In this example we construct specimen with a notch as presented in Figure 8. The specimen dimensions are given in millimeters. The proposed values of material properties are: $K=17.0$ GPa, $G=15.0$ GPa, $\sigma_u=6.5$ MPa and $G_{f,t}=0.14$ N/mm.

A double-notched specimen is constructed by placing notch on two side of specimen, at the one-third and at two-thirds of the specimen length.

Figure 9 shows localization of displacement in loading direction. It can be noted that for single notched specimen all displacement at the end of computation

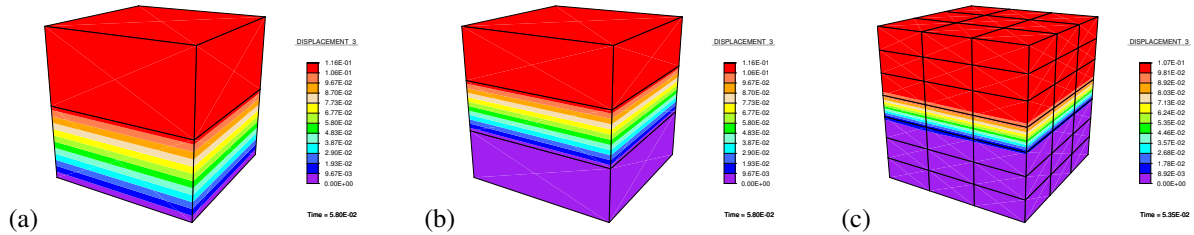

Figure 7: Vertical displacement at the end of uniaxial tension test for three different mesh versions: (a) 2 elements; (b) 3 elements; (c) 63 elements

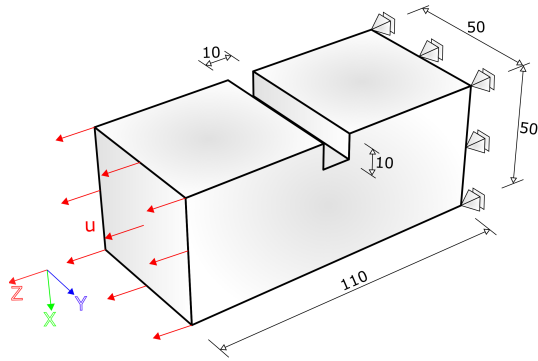

Figure 8: Notched specimen: geometry, boundary conditions and loading

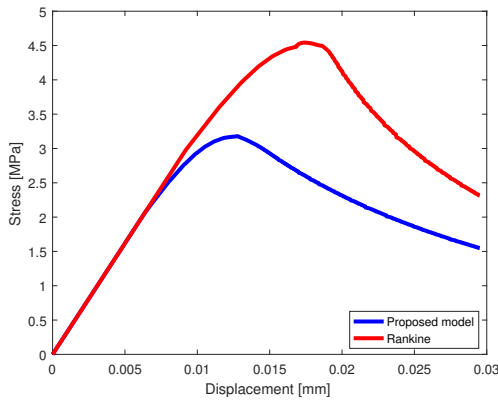

Figure 11: Macroscopic response for notched specimen in tension

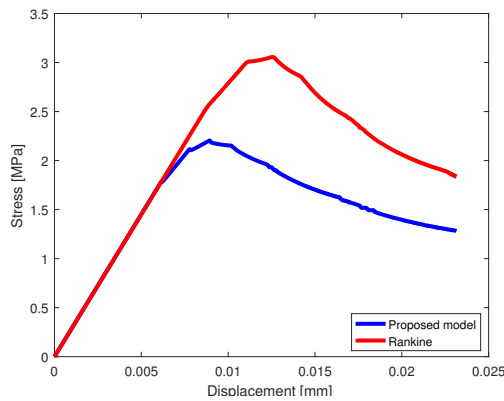

Figure 12: Macroscopic response for double-notched specimen in tension

are localized where we placed notch, while for double-notched specimen this zone connect two notches.

Figure 10 reveals that at the end of computation single notch specimen is split in two parts with flat failure

surface while for double-notched specimen failure surfaces split specimen in two L-shaped parts.

Macroscopic response (stress vs. imposed displacement) is presented in Figure 11 and 12 for both specimen and compared to response obtained with Rankine type of failure. Again, due to definition of elasticity limit stress in proposed model we can observe different limit stress for these two kinds of computed response.

4.3. Three point notched beam

We consider a simply supported concrete beam (Figure 13) of length $l = 2000$ mm, height $h = 200$ mm and thickness $t = 50$ mm. At its half-length it has a notch of dimensions $a = 10$ mm and $b = 100$ mm. The beam is loaded at the middle of the span, on the upper edge, with imposed vertical displacement. The material properties are chosen as in [31]: elastic modulus $E = 30$ GPa, Poisson ratio $\nu = 0.2$, ultimate strength $\sigma_u = 4.5$ MPa and fracture energy $G_{f,i} = 0.120$ N/mm. Figure 13 shows the used finite element mesh with geometry, boundary conditions and loading. Computation is performed under displacement control.

In Figure 14 is presented dependence of the reaction force on the imposed displacement for coarse and fine mesh, with 20 (mesh 1) and 40 (mesh 2) finite element along the height of the beam. We can note that for small number of element in the region where the crack is expected to occur and propagate force-displacement curves exhibit jumps. At jump, the crack propagated through the element much faster for coarse mesh than to the response with refined mesh. Moreover, we can note nice matching of the computed results with the range of experimental data presented in [32]. Upper and lower curve from experiment corresponds to $G_{f,i} = 0.137$ N/mm and $G_{f,i} = 0.115$ N/mm, respectively. The crack propagates along the mesh only in mode I (crack opening mode). This is also evident from Figure 15 where final deformed configuration of the mesh is presented.

4.4. Shear test

The shear-box test is widely used test to determine the shear strength of soils, rock and similar materials. This test has fallen from favor as an instrument of fundamental research because it tends to give non-uniform stresses in the rupture zone [33]. In order to obtain uniform stresses, a so-called simple-shear apparatus was developed [34] in such way (Figure 16.b) that all normal strains can be kept equal to zero, so that we have a so-called isochoric test (with no volume changes). These tests are used for soils and also in some previous research projects for concrete [33]. Thus, we consider

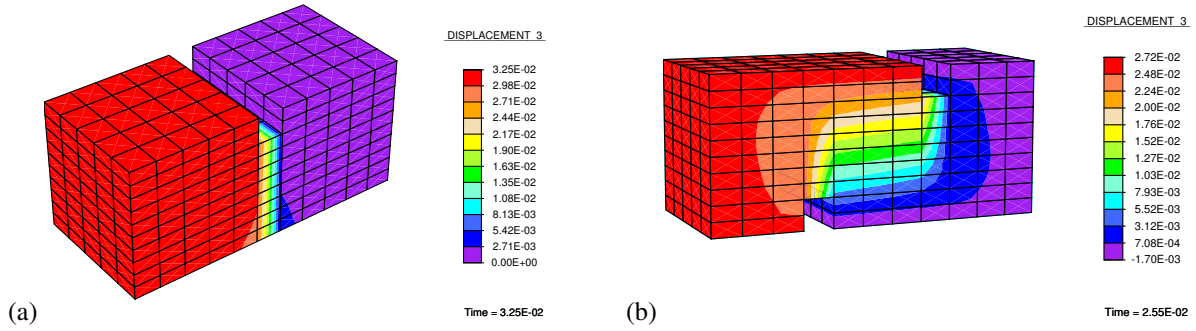

Figure 9: Displacement in loading direction at the end of numerical simulation:(a) Notched specimen ; (b) Double-notched specimen

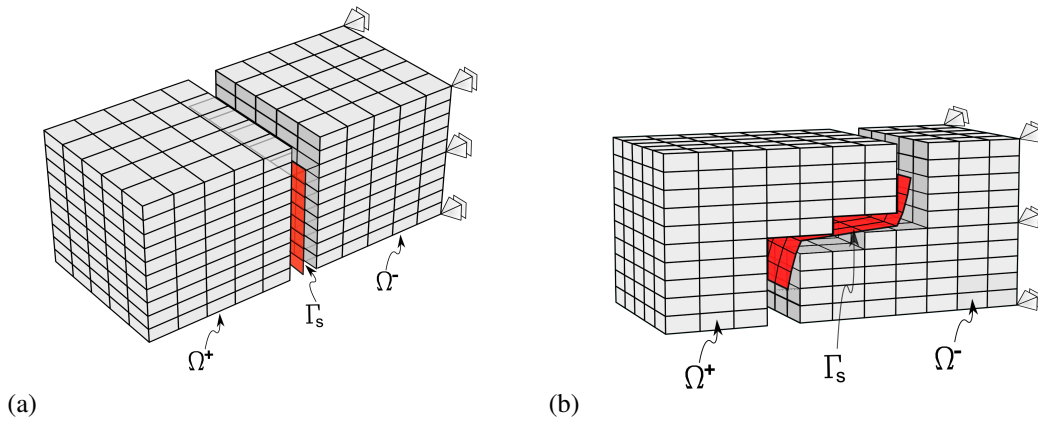

Figure 10: Mesh without fractured elements with discontinuity surface Γ_s ; (a) Notched specimen ; (b) Double-notched specimen

such test for sand in order to verify proposed model, but it can be also used for concrete-like materials. The material properties are: $E=45$ MPa, $\nu=0.2$, $\Phi=43^\circ$ and $\sigma_y=K_{h,lin}=\beta=0$. For the initial stress state in the specimen, we assume $\sigma_{yy} = -100$ kPa, $\sigma_{xx} = \sigma_{zz} = -25$ kPa and $\sigma_{xy} = 0$. During the test all strain rates vanish, with the exception of the shear-strain rate $\dot{\gamma}_{xy}$. Test is performed on cube specimen with 15 cm side length under displacement control.

In Figure 16.a is presented dependency of shear stress on shear strain which fits well with results given in [35]. The upper curve is obtained for a dilatancy angle of 15° . Despite the use of a non-hardening model, this curve shows hardening. Indeed, the slope of the curve gradually decreases to reach a constant, but positive value. So elastic-perfectly plastic models do not necessarily involve limit loads. When using a negative dilatancy angle, we find the lower curve presented in Figure 16.a. This stress-strain curve gradually approaches a line with a negative slope. In other words, hardening is followed by softening and during this unstable behavior the shear resistance vanishes completely. Thus, even if the model

is based on perfect plasticity we find softening behavior which is due to non-associated plasticity.

In order to arrive at a better understanding of this phenomenon, it is helpful to consider the stress path for the isochoric shear test in principal stress space. The stress path begins at the point A with coordinates $A_{\sigma_1} = -100$ kPa and $A_{\sigma_2} = A_{\sigma_3} = -25$ kPa. Then the stresses are more or less controlled by the elastic volume change. In the beginning of the test the strains are entirely elastic, so that the condition of zero volume strain implies that sum of stress rate is also equal to zero. This give a elastic path until we reach the yield surface. From this point on plastic strains develop, including plastic volume change when Ψ is non-zero. Then an elastic volume change is needed to compensate for the plastic volume change. For a negative dilatancy angle, plastic contraction must be balanced by elastic expansion, or $\epsilon_v^e = -\epsilon_v^p$. The elastic expansion gives rise to tensile stress increments, so that the existing compressive stresses will vanish. Then we can note that the plastic strain-rate vector forms an obtuse angle with the stress rate vector. As a consequence the inner product is negative ($\dot{\sigma}^T \dot{\epsilon}^p < 0$),

K	15 GPa
G	15 GPa
σ_y	10.0 MPa
β	7500.0
σ_∞	36.7 MPa
$K_{h,lin}$	10.0 MPa
σ_u	6.5 MPa
$G_{f,c}$	20.0 N/mm
$\tan(\Phi)$	0.3
$\tan(\Psi)$	0.3

Table 2: Material parameters for uniaxial compression test

which is the Drucker definition of unstable material behavior. The negativeness of the above inner product is a necessary but not a sufficient condition for softening behavior. For softening we need to consider the inner product of the stress rate and the total strain rate rather than the plastic strain rate. The total strain rate is always parallel to the line of elastic path, making an obtuse angle to the stress-rate vector. Finally it is noted that softening is not only possible for $\Psi < 0$ but more generally for $\Psi < \Phi$.

4.5. Compression test

The results of numerical simulations and corresponding macroscopic response for specimen under uniaxial (unconfined) compression loading program are given here. Simulations in compression test are conducted with displacement control, while lateral displacements are unrestrained which corresponds to the case with no friction between the load platen and the specimen. Geometry of specimen is the same as for specimen used for uniaxial tension test. Table 2 summarizes the chosen mechanical properties of specimen where σ_y is yield stress defined for a simple tension test, β is the hardening parameter that governs the rate with which the saturation is achieved, σ_∞ is limit stress until the stress increase, $K_{h,lin}$ is hardening modulus, σ_u is ultimate stress which triggers the softening, $G_{f,c}$ is fracture energy in compression, while $\tan(\Phi)$ and $\tan(\Psi)$ are internal friction angle and dilatancy angle defined in meridian plane.

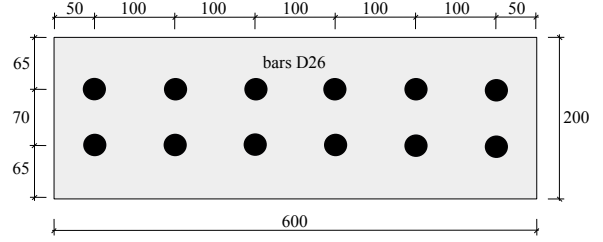

Figure 19: Bending test cross-section

Figure 17.a shows macroscopic stress (sum of all reactions in vertical direction divided by cross-section area of concrete cube) versus strain curves for saturation type of hardening (black line) and linear isotropic hardening (red line). The macroscopic limit stress which triggers the softening changes due to the type of hardening while limit strains remains the same. This is in accordance with the concrete material model, which is defined in terms of limit strains. Also, we can find that for non-associative hardening limit stress is not changed but only the total dissipation energy in small amount.

The difference with respect to uniaxial tension test mechanism concerns the ductile phase of the response during creation of the fracture process zone, which is more pronounced in compression test than in tension test. Thus, not only the ductile part with fracture process zone is larger, but also its contribution to the total dissipation in compression failure.

In order to compare the macroscopic responses corresponding to uniaxial tension and compression, Figure 17.b presents macroscopic curves and reveals that the overall compression-tension ratio is equal to 8.5 which fits well to typical observation made for a concrete [36, 37].

4.6. Bending test on a reinforced concrete beam

We consider here a beam of length $L = 8.89$ m, with a rectangular cross-section: width 60 cm and height 20 cm. Six reinforcement longitudinal bars of diameter 26 mm are placed at the top side, and six with the same diameter at the bottom side of the cross-section (see Figures 18 and 19 for details on the geometry). This test was proposed as a benchmark for different failure modes of reinforced concrete by ETH Institute for Concrete Structures [38], who also provided a detailed description of the chosen test specimens.

Three loading condition are considered. In each case, the beam is subjected to three loads Q applied vertically in the span between the two supports and a load P applied at the free end. The first test, marked as T_0 , is

K	15.482 GPa
G	12.998 GPa
σ_y	10.0 MPa
β	7000.0
σ_∞	36.7 MPa
σ_u	6.1 MPa
$G_{f,c}$	21.5 N/mm
$G_{f,t}$	0.5 N/mm
$\tan(\Phi)$	0.32
$\tan(\Psi)$	0.21

Table 3: Material parameters for bending test

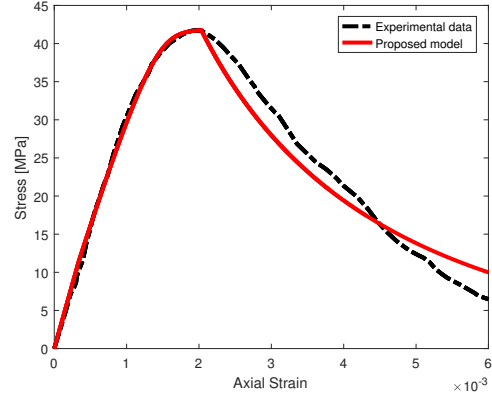

Figure 22: Comparison of results: macroscopic stress-strain response

performed without axial load T , while in test T_1 and T_2 axial load T is limited to 1911 kN and 956 kN, respectively. All tests follow the same procedure: First, the axial load T is increased linearly up to the chosen value and held constant. Second, the transverse loads Q and P are increased linearly with $P = 8.58 \text{ kN} + 1.44Q$ for test T_0 , $P = 15.84 \text{ kN} + 1.90Q$ for test T_1 , $P = 12.21 \text{ kN} + 1.68Q$ for test T_2 .

The material properties of concrete, as summarized in Table 3,, are determined by inverse procedure in order to obtain matching of stress-strain diagram for compression test (Figure 20) with average experimental results performed on a cube and cylinder specimen [38]. For the steel bar we use truss element with Von Mises plasticity model.

Material properties for bars are: Young's modulus of elasticity, $E_s = 215 \text{ GPa}$, Yield strength, $f_{sy} = 498 \text{ MPa}$, Hardening modulus $K_{sh} = 20 \text{ GPa}$. Interface between concrete and steel is represented with perfect bond providing that the dilatations in adjacent steel and concrete remain the same in each step of computation. The computation is carried out using the arc-length method (e.g. [10]). The mesh grading in the horizontal direction is chosen to comply with solid/truss elements of length 0.2 m. In the vertical direction, the finite element mesh along cross-section is built up in order to ensure position of longitudinal steel bars. This results with the mesh with 112 and 224 FE along cross-section (Figure 22).

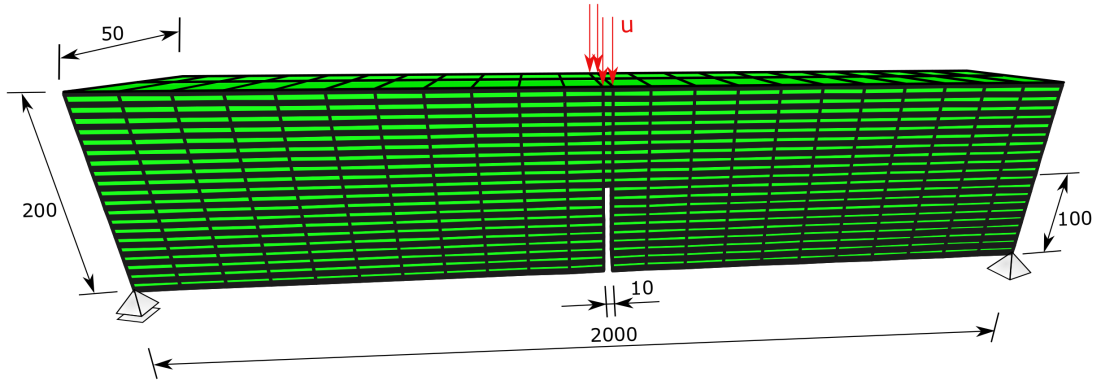

Figure 13: Three point notched beam: geometry, boundary conditions and loading

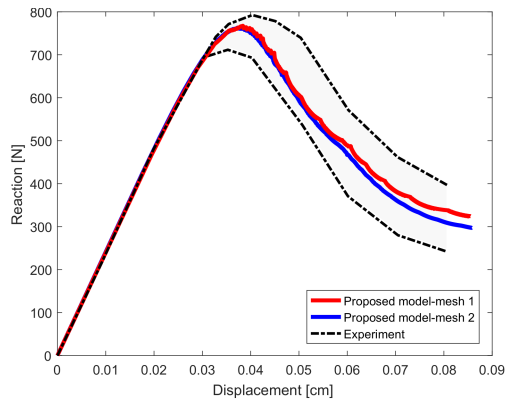

Figure 14: Load-displacement diagram for three point notched beam and comparison with the experimental results

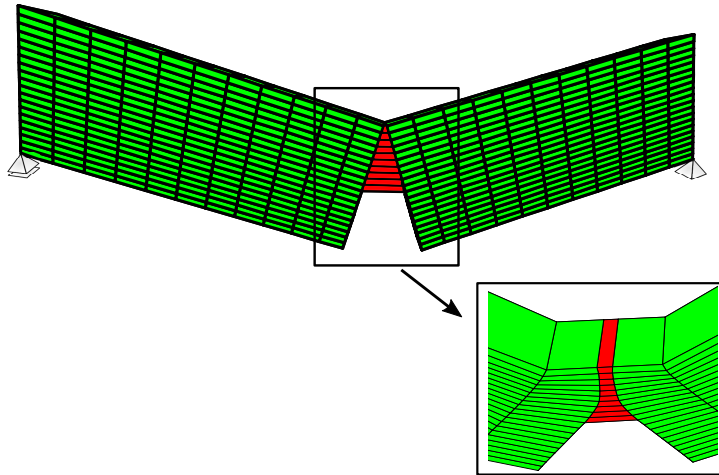

Figure 15: Three point notched beam: deformed mesh

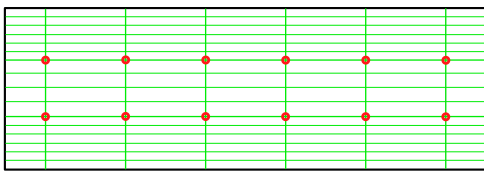

Figure 22: Bending test cross-section finite element mesh (red circles represent position of truss element)

Figure 21 (upper part) shows the state of specimen at the end of computation, where white color represents elements that remain in elastic phase, green color represents hardening in compression and red color represents element in softening phase. A major part of the concrete cross-section starts softening in tension (the bottom part between the supports and the top part above the right support). Concrete gets into the hardening phase

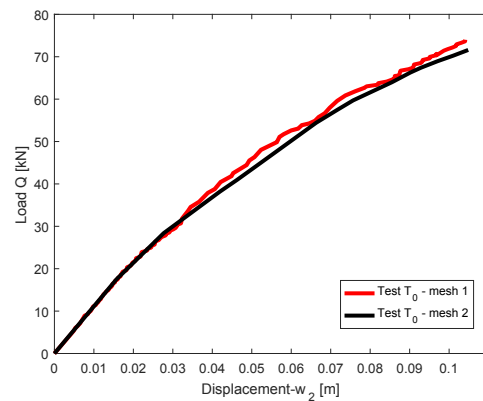

Figure 23: Load Q in terms of the deflection at the mid-point of the inner span

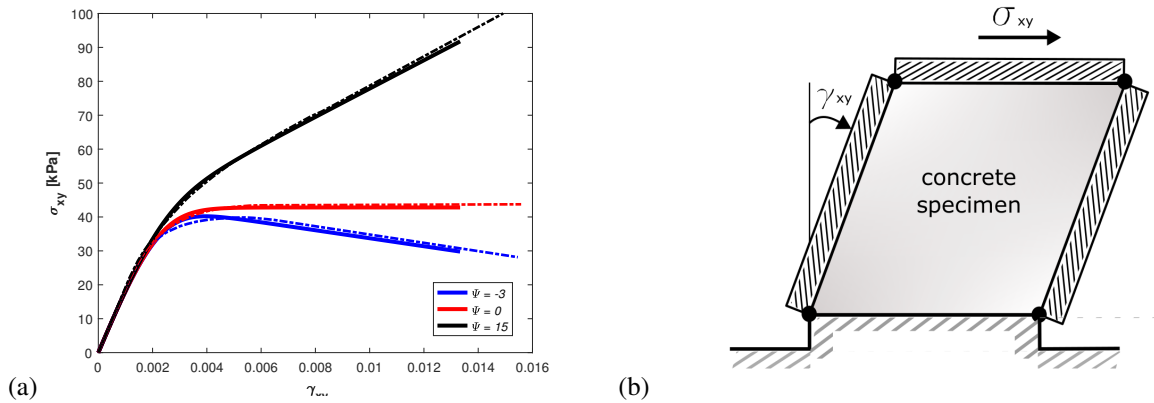

Figure 16: Isochoric shear test: (a) Computed responses (solid line) and results taken from [35] (dash line); (b) boundary conditions and loading

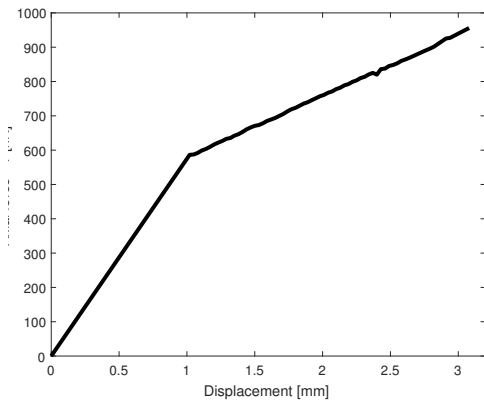

Figure 24: Load T in terms of the resulting displacement for test T_2

of compression in the top layers at the middle of the span and the bottom ones above the right support. A few steps before the end of the analysis, the compressed layers of concrete above the right support also start soft-

ening. Also, the top reinforcement layer above right support starts to yield just before the end of analysis.

Figure 21 (middle) shows that crack propagates mostly due to tension stress, while crack above right support propagates due to compression stress.

The results for test T_0 , for two adopted FE mesh, in terms of load/deflection are given in Fig. 23 (Q in terms of deflection at the mid-point of the inner span). We can note that after major part of beam starts softening global resistance decrease. This computation is limited to predefined load because further load increase can not drive the beam to total failure due to elastoplastic model of steel bar.

For test marked as T_1 and T_2 at the end of first phase, when beam is subjected to axial load, all element reaches elastic limit stress point in tension, thus forming cracks along the beam which are perpendicular to the subjected load (Figure 21- lower). Figure 24 reveals that during first phase, the global stiffness of the beam is decreased and latter transverse loads is transferred only

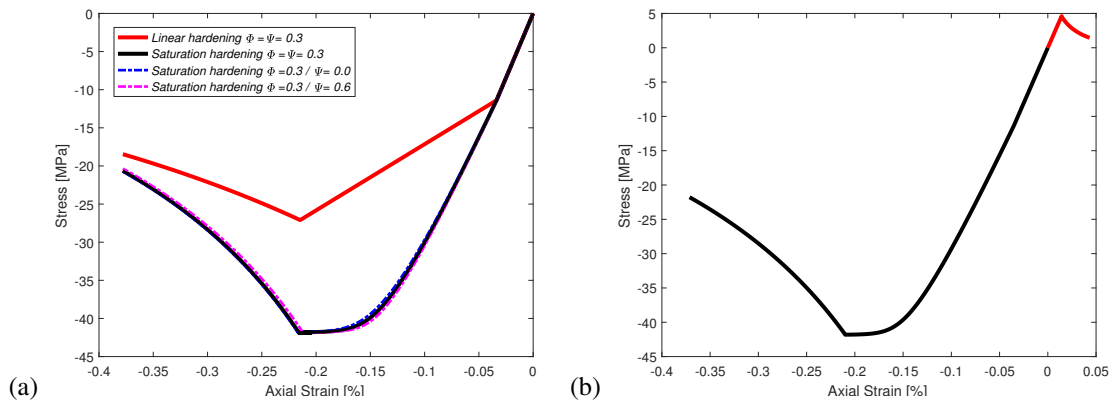

Figure 17: Macroscopic response: (a) uniaxial compression test; (b) complete response

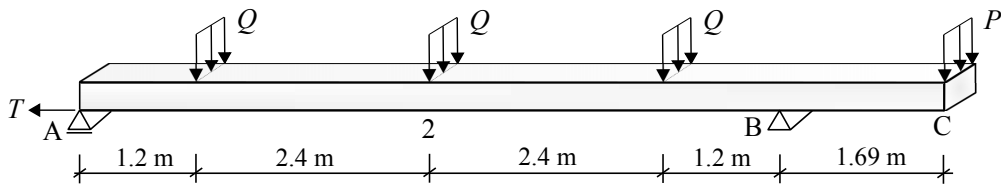

Figure 18: Bending test: loading and geometry

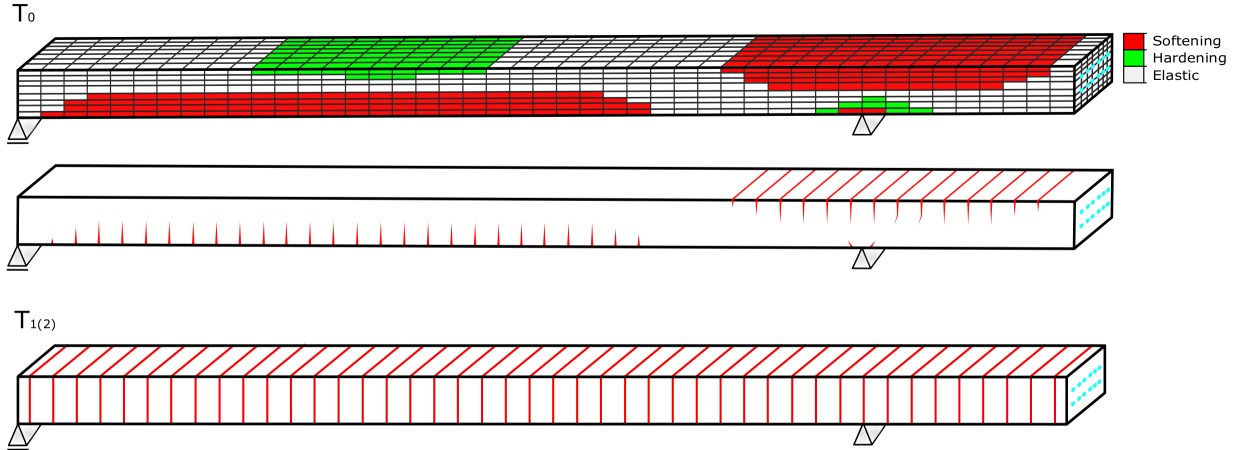

Figure 21: Bending test: state of specimen and crack propagation

through the steel bars until they starts yielding.

To validate the prediction of our model, we compared the obtained results with the stress-resultant reinforced-concrete model for Timoshenko beam that can capture the localized failure in shear, see [39]. We have also compared our results against the experimental results (Figure 25). The prediction result we obtain in terms of crack pattern for concrete fits well with these experimental results.

5. Conclusions

In this work we proposed multisurface plasticity model for concrete that takes into account both the contribution of a strain hardening with non-associative flow rule as well as a strain softening model components for full set of different 3D failure modes. The proposed model is capable of representing the localized failure of massive structures, where final failure mechanism is preceded by significant development of plastic deformations in so-called fracture process zone, which provides an important contribution to total plastic dissipation as the final failure mechanism. The plasticity model is represented with Drucker-Prager yield criterion, with similar plastic potential function governing hardening

behavior while strain softening behavior is represented with St. Venant criterion.

We illustrated here that the model of this kind ensures complete mesh independency of the discrete approximation constructed by the finite element methods. In particular, for representing the failure, a displacement jump is embedded in the element to describe the post-peak behavior. Another feature of the model is ability to represent nonlinear volume change during hardening, which is obtained by using plastic potential function defining the plastic flow rule, which is similar to (but not the same as) the yield function.

The model is validated by presenting several numerical examples where we confirm that the resistance of concrete to tension is much lower than the one in compression. The computed results fits quite well with the corresponding experimental results, pertinent not only to global but also to local results, such as the resulting crack pattern for the bending test on a reinforced concrete beam.

Although the chosen model problem considers plasticity model, the proposed concept of combining the inelastic hardening and inelastic softening to fully explain the failure of a massive structure can easily be adapted to other models of inelastic response, such as damage or

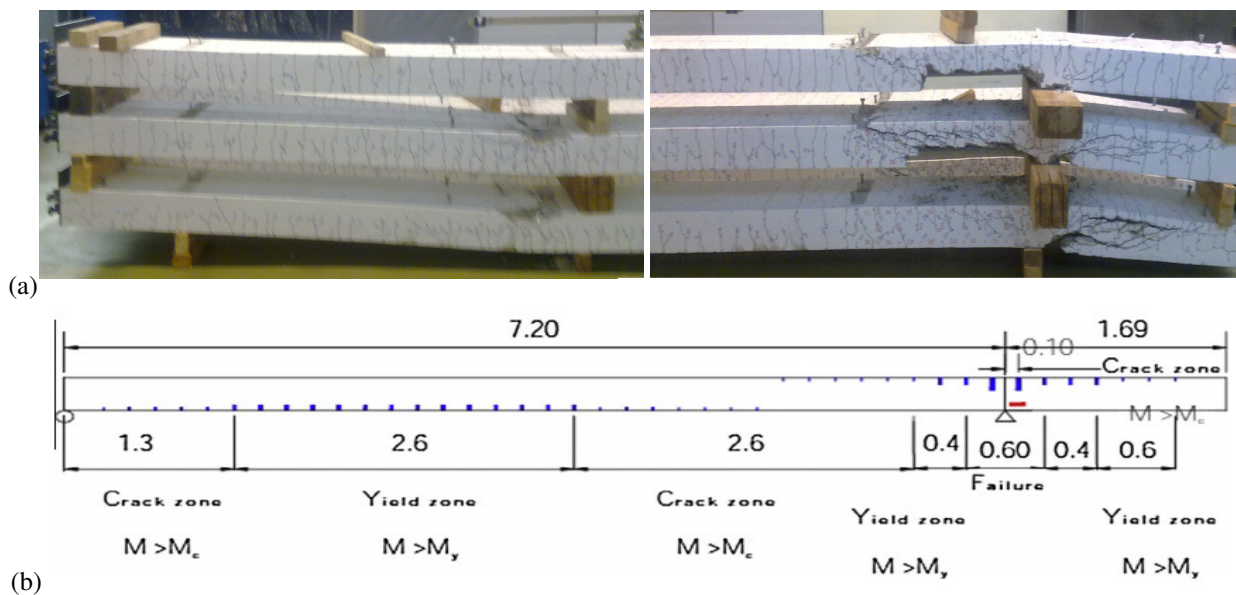

Figure 25: Crack propagation: (a) experimental results for test T_0 -lower beam, T_2 -middle beam, T_1 -upper beam; (b) results taken from [39]

combined damage plasticity.

Acknowledgements

This work was supported jointly by Hauts-de-France Region (CR Picardie) with EU funding (FEDER-120-2015-RDISTRUC-000010) for Chaire-de-Mecanique, IUF-Institute Universitaire de France (Membre Senior), French National Research Agency (ANR SELF-TUM project) and a scholarship by French Embassy in Sarajevo. This support is gratefully acknowledged

References

- [1] Dugdale D., Yielding of steel sheets containing slits, *J. Mech. Phys. Solids* 8 (1960) 100108.
- [2] Barenblatt G., The mathematical theory of equilibrium cracks in brittle fracture, *Adv. Appl. Mech.* 7 (1962) 55129.
- [3] Jirasek M., Zimmermann Th., Analysis of rotating crack model, *J. Eng. Mech. ASCE* 124 (1998) 842-851.
- [4] Jirasek M., Zimmermann Th., Rotating crack model with transition to scalar damage, *J. Eng. Mech. ASCE* 124 (1998) 277-284.
- [5] Bittencourt T.N., Wawrzynek P.A., Ingraffea A.R., Sousa J.L., Quasi-automatic simulation of crack propagation for 2D LEFM problems, *Engineering Fracture Mechanics* 55 (2), 321-334.
- [6] Borst Rüd., Sluys L.J., Mühlhaus H.B., Pamin J., Fundamental issues in finite element analyses of localization and deformation, *Engineering Computations* 1993, 10:99-121.
- [7] Pijaudier-Cabot G., Bazant Z., Nonlocal damage theory, *ASCE Journal of Engineering Mechanics* 1987;113(10):1512-33.
- [8] Bazant Z., Pijaudier-Cabot G., Nonlocal continuum damage, localization instability and convergence, *ASME Journal of Applied Mechanics* 1988;55:287-93
- [9] Grassl P., Jirsek M., Damage-plastic model for concrete failure, *International journal of solids and structures* 43 (22-23), 7166-7196, 2006.
- [10] Ibrahimbegovic A. *Nonlinear Solid Mechanics: Theoretical Formulations and Finite Element Solution Methods*, Springer, London, 2009.
- [11] Ibrahimbegovic A., Brancherie D. Combined hardening and softening constitutive model of plasticity: precursor to shear slip line failure, *Comput Mech* 31 (2003) 88-100
- [12] Simo J.C., Oliver J., Armero F., An analysis of strong discontinuities induced by strain-softening in rate-independent inelastic solids, *Comput Mech* 12 (1993) 277-296
- [13] Oliver J., Continuum modelling of strong discontinuities in solid mechanics using damage models, *Comput. Mech.* 17 (12) (1995) 4961.
- [14] Feist C., Hofstetter G., An embedded strong discontinuity model for cracking of plain concrete, *Computer Methods in Applied Mechanics and Engineering* 195 (52), 7115-7138
- [15] Mosler J., Meschke G., Analysis of mode I failure in brittle materials using the strong discontinuity approach with higher order elements, in: *2nd European Conference on Computational Mechanics*, Cracow, 2001
- [16] Mosler J., Meschke G., 3D modeling of strong discontinuities in elastoplastic solids: fixed and rotating localization formulations, *Internat. J. Numer. Methods Engrg.* 57 (11) (2003) 15531576.
- [17] Jirasek M., Zimmermann T., Embedded crack model: Basic formulation. *Int. J. Numer. Meth. Eng.* 50: 12691290, 2001.
- [18] Armero F., Garikipati K., Recent advances in the analysis and numerical simulation of strain localization in inelastic solids In: Owen E., Onoate DRJ, Hinton E (eds), *Proceedings of Computational Plasticity IV*, pp. 547561 Barcelona, CIMNE, 1995.
- [19] Ortiz M., Leroy Y., Needleman A. A finite element method for localization failure analysis, *Comput Methods Appl Mech Engrg* 61 (1987) 189-214
- [20] Belytschko, T., Fish, J., Engelman, B.E., 1988. A Finite element with embedded localization zones. *Computer Methods in Applied Mechanics and Engineering* 70, 59-89.
- [21] Sluys, L.J., Berends, A.H., 1998. Discontinuous failure analysis

- sis for mode-I and mode-II localization problems. *International Journal of Solids and Structures* 35 (31-32), 4257-4274.
- [22] Kratzig, W. B., Plling, R. (2004), An elastoplastic damage model for reinforced concrete with minimum number of material parameters. *Computers and Structures*, 82(15-16), 12011215.
- [23] Stanic A., Solution methods for failure analysis of massive structural elements., Ph.D. thesis, University of Technology in Compiègne, France, 2017.
- [24] Do, X.N., Ibrahimbegovic, A., and Brancherie, D. (2017). Dynamics framework for 2D anisotropic continuum-discrete damage model for progressive localized failure of massive structures. *Computers and Structures*, 183:14-26
- [25] Ibrahimbegovic A., Wilson E. A modified method of incompatible modes, *Commun Appl Numer Method* 7 (1991) 187-194
- [26] Karavelic E, Nikolic M, Ibrahimbegovic A (2017) Concrete meso-scale model with full set of 3D failure modes with random distribution of aggregate and cement phase. Part I: Formulation and numerical implementation. *Comput. Methods Appl. Mech. Engrg.*, doi:10.1016/j.cma.2017.09.013
- [27] Chen, A.C., Chen, W.F., Constitutive relations for concrete. *Journal of Engineering Mechanics Division, ASCE* 101, 465481, 1975.
- [28] Willam, K. J. and Warnke, E. P., Constitutive models for the triaxial behavior of concrete. *Proceedings of the International Assoc. for Bridge and Structural Engineering* , vol 19, pp. 1-30,1975.
- [29] Ulm, F-J., Coussy, O., Bazant, Z., The "Chunnel" Fire. I: Chemoplastic softening in rapidly heated concrete. *ASCE Journal of Engineering Mechanics*, vol. 125, no. 3, pp. 272-282, 1999.
- [30] R.L. Taylor, FEAP Finite element Analysis Program. University of California, Berkeley, <http://www.ce.berkeley.edu.rlt>
- [31] Linder, C., Armero, F. 2007. Finite elements with embedded strong discontinuities for the modeling of failure in solids. *International Journal for Numerical Methods in Engineering* 72: 1391-1433.
- [32] Petersson, P. E. 1981. Crack growth and development of fracture zones in plain concrete and similar materials. Report No. TVBM-1006, Division of Building Materials, University of Lund, Lund, Sweden, 1981.
- [33] Christensen, J. and K. Willam, Finite element analysis of concrete in shear, *Proc. Symp. on the Interaction of Non-nuclear Munitions with Structures*, U.S. Air Force Academy, Colorado, 101-106,1983
- [34] Roscoe, K. H., An apparatus for the application of simple shear to soil samples, *Proc. 3rd Int. Conf. Soil Mech., Zurich, Vol. 1*, 129-170,1953.
- [35] Vermeer P. A.,de Borst R., *Non-associated plasticity for soils, concrete and rock*,Heron, 1984.
- [36] Kupfer H., Hilsdorf H.K. Behavior of concrete under biaxial stress, *ACI J Proc* 66 (1969) 656-666
- [37] Carpinteri A., Ingrassia AR.,*Fracture mechanics of concrete*, Martinus Nijhoff editor, The Netherlands, 1984
- [38] ETH Zurich, IBK, RC Tie Beam Prediction Competition; 2013. <http://www.ibk.ethz.ch/ma/competition>.
- [39] Bui N.N., Ngo M.,Nikolic M., Brancherie D., Ibrahimbegovic A., Enriched Timoshenko beam finite element for modeling bending and shear failure of reinforced concrete frames, *Comput Struct*, 143 (2014) 918.