



**HAL**  
open science

# Optimal cement paste yield stress for the production of stable cement foams

Blandine Feneuil, Nicolas Roussel, Olivier Pitois

## ► To cite this version:

Blandine Feneuil, Nicolas Roussel, Olivier Pitois. Optimal cement paste yield stress for the production of stable cement foams. *Cement and Concrete Research*, 2019, 120, pp.142 - 151. 10.1016/j.cemconres.2019.03.002 . hal-03484798

**HAL Id: hal-03484798**

**<https://hal.science/hal-03484798v1>**

Submitted on 20 Dec 2021

**HAL** is a multi-disciplinary open access archive for the deposit and dissemination of scientific research documents, whether they are published or not. The documents may come from teaching and research institutions in France or abroad, or from public or private research centers.

L'archive ouverte pluridisciplinaire **HAL**, est destinée au dépôt et à la diffusion de documents scientifiques de niveau recherche, publiés ou non, émanant des établissements d'enseignement et de recherche français ou étrangers, des laboratoires publics ou privés.



Distributed under a Creative Commons Attribution - NonCommercial 4.0 International License

1 Optimal cement paste yield stress for the production of  
2 stable cement foams

3 Blandine Feneuil<sup>a</sup>, Nicolas Roussel<sup>a</sup>, Olivier Pitois<sup>a,\*</sup>

4 <sup>a</sup>Laboratoire Navier, UMR 8205, École des Ponts ParisTech, IFSTTAR, CNRS, UPE,  
5 Champs-sur-Marne, France

---

6 **Abstract**

7 Production of morphology-controlled cement foams remains challenging, mainly  
8 due to bubble stability issues during cement setting. The use of cement paste  
9 with high yield stress is expected to promote stability by damping intrinsic  
10 bubble kinetics. Here we show however that for given W/C ratio, fresh foam  
11 stability can be achieved instead by decreasing the yield stress of the cement  
12 paste. Indeed, in this low apparent yield stress regime, van der Waals attrac-  
13 tion between cement grains is reduced and grains are allowed to be efficiently  
14 packed by bubbles, providing enhanced mechanical properties. This result is  
15 obtained for two distinct additives used at controlled concentrations and with-  
16 out resorting to set accelerators, which highlights the general significance of the  
17 underlying stability mechanism. It offers a promising solution to produce stable  
18 cement foams at high air content.

19 *Keywords:*

20 foam, rheology (A), cement paste (D)

---

\*Corresponding author

*Email address:* [olivier.pitois@ifsttar.fr](mailto:olivier.pitois@ifsttar.fr) (Olivier Pitois)

21 **Notations**

$R$	Initial bubble radius in a foam
$\gamma$	Air-liquid surface tension
$\rho_{liq}$	Liquid density (1.0 g/cm <sup>3</sup> )
$\rho_c$	Cement density (3.2 g/cm <sup>3</sup> )
$\Phi$	Air volume content
$\Delta P$	Pressure applied on cement paste during water extraction measurements
$\tau_{y,0}$	Yield stress of reference cement paste, i.e. the unfoamed cement paste with the same water and additives content as the cement foam. This value is measured by spread test.
$\rho$	Cement paste density
$W/C_i$	Water to cement ratio in cement paste before mixing with precursor aqueous foam.
$W/C_f$	Water to cement ratio in reference cement paste
22 $\tau_{y,0}^*$	Critical value of reference cement paste yield stress above which cement foams are unstable
$\tau_{y,0}^{**}$	Critical value of reference cement paste yield stress below which cement foams are unstable
$\tau_{y,foam}$	Cement foam yield stress measured by start-of-flow experiment
$\tau_{y,aq}(\Phi)$	Yield stress of aqueous foam calculated at air volume content $\Phi$ .
$\tau_{y,int}$	Yield stress of interstitial cement paste calculated from the cement foam yield stress $\tau_{y,foam}$ .
$G_{foam}$	Measured cement foam elastic modulus
$G_{aq}(\Phi)$	Elastic modulus of aqueous foam calculated at air volume content $\Phi$ .
$G_{int}$	Elastic modulus of interstitial cement paste calculated from the cement foam elastic modulus $G'_{foam}$ .
$\Phi_c$	Maximal volume fraction of spheres, we take $\Phi_c = 0.64$

## 23 1. Introduction

24 Cement foams are highly porous materials, which offer interesting thermal  
25 insulation properties. When cement foam density decreases, thermal resistance  
26 is improved but mechanical strength decreases [1]. The control of the pore  
27 morphology is a crucial issue to optimize all macroscopic properties at a given  
28 density. For example, pore size and pore connections are control parameters for  
29 acoustic absorption [2] and flow permeability [3].

30 Several foam production methods have been reported in literature, including  
31 chemical foaming, air entrainment and mixing with aqueous precursor foam. In  
32 the precursor foam method, cement slurry and aqueous foam are prepared sep-  
33 arately before being mixed together. The resulting cement foam morphology  
34 depends on (1) the precursor foam morphology, (2) the capacity of the mix-  
35 ing process to preserve the precursor foam bubble sizes and (3) the bubble size  
36 evolution in the sample at rest until cement setting. The third point is chal-  
37 lenging. As long as the interstitial material is not solid, foam destabilization  
38 occurs through three mechanisms [4]: drainage is caused by density difference  
39 between air bubbles and cement paste, ripening is a gas transfer from smaller  
40 bubbles to bigger bubbles, and coalescence refers to thin film breakage between  
41 two neighbor bubbles. Both drainage and ripening are affected by the consis-  
42 tency of the suspending fluid, so a promising method to stop or slow them down  
43 is to increase the yield stress of the interstitial material [5, 6, 7].

44 In the case of cement foams, yield stress of the interstitial paste results from  
45 attractive interactions between cement grains. It depends on both the inten-  
46 sity of these interparticle forces and particle volume content [8]. The latter is  
47 related to the water-to-cement ratio whereas interparticle forces can be tuned  
48 by additives [9]. For instance, superplasticizers adsorb on cement grains, which  
49 causes steric repulsion between cement grains and, at the macroscopic scale, the

50 decrease of the yield stress [10]. In a cement foam made from precursor aque-  
 51 ous foam, surfactants are needed to ensure the stability of the films separating  
 52 the bubbles. Some of them, mainly anionic surfactants, have been shown to  
 53 have a strong affinity towards cement grains and change the yield stress of the  
 54 constitutive paste [11]. When they are added in small amount in cement paste,  
 55 adsorbed molecules form an hydrophobic layer on cement grains and promote  
 56 hydrophobic attraction, which leads to an increase of the macroscopic yield  
 57 stress. On the other hand, when large amount of anionic surfactant is added to  
 58 cement paste, surfactant molecules agglomerate into micelles or double layers  
 59 on cement grains surface and leads to steric repulsion and a strong decrease of  
 60 the yield stress [11].

61 In this paper, we investigate the effect of cement paste yield stress on the  
 62 stability of cement foams. The yield stress is controlled by using additives, ei-  
 63 ther superplasticizer or appropriate amount of anionic surfactant. Additionally,  
 64 in order to indirectly assess the rheological behavior of the cement paste as con-  
 65 fined between the bubbles, we perform rheological measurements on the cement  
 66 foams.

## 67 2. Materials and methods

### 68 2.1. Materials

69 Cement is a CEM I from Lafarge, from Lagerdorf factory. Specific surface  
 70 provided by the manufacturer is  $0.433 \text{ m}^2/\text{g}$ . Chemical composition is given in  
 71 table 1.

C <sub>3</sub> S	C <sub>2</sub> S	C <sub>3</sub> A	C <sub>4</sub> AF	CaO/SiO <sub>2</sub>	MgO	Na <sub>2</sub> O +0.658 K <sub>2</sub> O	SO <sub>3</sub>	Gypsum
60%	13%	2%	13%	3	0.8%	0.5 %	2.5%	4%

Table 1: Chemical composition of CEM I cement from Lafarge, Lagerdorf

72 Two different surfactants are used. Steol<sup>®</sup> 270 CIT is an anionic surfactant  
 73 provided by Stepan. Its molar mass indicated by the manufacturer is 382 g/mol  
 74 and the active content is 68-72%. Steol Critical Micelle Concentration (CMC)  
 75 is 1.5 g/L in water and 0.3 g/L in cement pore solution [11]. Triton<sup>™</sup> X-100  
 76 (laboratory grade) is a non-ionic surfactant provided by Sigma-Aldrich; molar  
 77 mass is 625 g/mol and CMC is 0.2 g/L in water and 0.15 g/L in cement pore  
 78 solution [11].

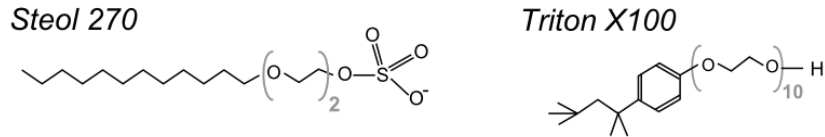

Figure 1: Chemical formula of the surfactants used in this study: Steol is anionic and Triton is non-ionic

79 When added into cement paste, Steol 270 has a strong affinity with cement  
 80 grains surface [11] and can either increase the cement paste yield stress at low  
 81 concentration or act as a deflocculant at high concentration. On the contrary,  
 82 non-ionic Triton has very low affinity with cement grains [12, 11] and does not  
 83 change the yield stress of the cement paste.

84 SIKA Tempo 12 superplasticizer has been used to modify cement paste yield  
 85 stress in cement foam samples containing non-ionic surfactant. It has been  
 86 checked that Tempo 12 does not alter the stability of aqueous foam made with  
 87 Triton: we have compared the foam volume obtained by shaking tubes contain-  
 88 ing a Triton solution with and without superplasticizer. Results are not shown  
 89 here, but details about the experimental method can be found in [11].

90 2.2. Methods

91 2.2.1. Protocol

92 In order to remove any influence of cement paste age on results, all cement  
93 foams are prepared following the same time schedule, from initial water and  
94 cement mixing to sample casting or rheometry measurement.

95 Water is mixed with cement paste at initial water-to-cement ratio  $W/C_i$   
96 = 0.35 or 0.32 and the resulting paste is left at rest for 20 minutes to allow  
97 for the formation of sulfo-aluminate phases. Then, a deflocculant is added.  
98 Deflocculant is either Steol surfactant added in large quantity or SIKA Tempo  
99 12 superplasticizer. The resulting cement paste is then mixed with precursor  
100 aqueous foam. Final water-to-cement ratio after addition of additive and foam  
101 is noted  $W/C_f$ . This procedure is schematized in Fig. 2.

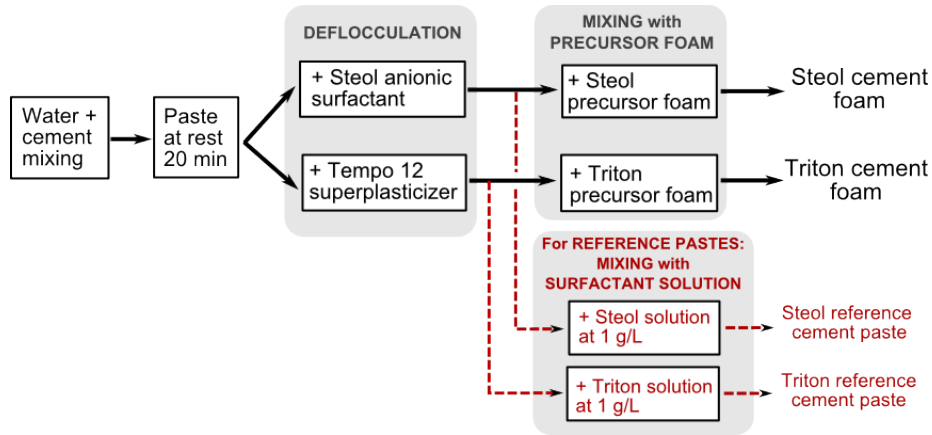

Figure 2: Preparation protocol of cement foams and reference cement pastes made with Steol anionic surfactant and Triton non-ionic surfactant.

102 In addition, reference cement pastes are prepared following the same protocol  
103 as cement foams, but only surfactant solution is added instead of aqueous foam  
104 (see Fig. 2). Reference cement pastes are then mixed slowly by hand to avoid  
105 any air entrainment.

106 *2.2.2. Precursor foam*

107 The generator used to produce the precursor aqueous foam is schematized in  
108 Fig. 3. Nitrogen and surfactant solution (concentration 1 g/L for both surfac-  
109 tants) flow in a T-junction of characteristic length  $l_T = 100 \mu\text{m}$ . The capillary  
110 pressure  $P_C$  depends on the gas-liquid surface tension  $\gamma \sim 10 \text{ mN/m}$  and is  
111  $P_C \sim \gamma/l_T \sim 10^2 \text{ Pa}$ . The hydrostatic pressure  $P_H$  depends on the liquid den-  
112 sity  $\rho_{liq} \sim 1000 \text{ kg/m}^3$ :  $P_H = \rho_{liq}gl_T \sim 1 \text{ Pa}$ . Therefore, as  $P_C \gg P_H$ , which  
113 means that capillary effects dominate over gravity effects, so liquid and gas pass  
114 alternately through the T-junction, which leads to the formation of bubbles.  
115 Bubble diameter depends on the flow rates of surfactant solution and nitrogen  
116 respectively.

117 The resulting bubbles are then collected in a vertical column. Imbibition  
118 flow at the foam top compensates liquid loss due to drainage and is used to  
119 tune the precursor foam liquid fraction. Note that, with such an approach, the  
120 vertical liquid fraction profile is uniform over the foam column. The precursor  
121 foam is mixed with cement paste about 40 minutes after the beginning of the  
122 generation, when ripening has not started to occur in the column.

123 Bubble radius for all precursor foams is  $R = 390 \pm 20 \mu\text{m}$  and the liquid  
124 fraction is equal to  $1.4 \pm 0.1\%$ .

125 *2.2.3. Mixing*

126 To mix the precursor foam with the cement paste, we use a convergent  
127 mixing device schematized in Fig. 3. Cement paste flows in a conic tube, the  
128 length of which is 4 cm. Then, mixing of paste and precursor foam takes place  
129 thanks to a 1.5 mm diameter constriction. Input flow rates are chosen so that  
130 the final air content is  $\Phi = 83\% \pm 1\%$ . Note that this mixing method involves  
131 the flow of the precursor cement paste in small tubes, which requires moderate  
132 cement paste yield stress (below about 40 Pa).



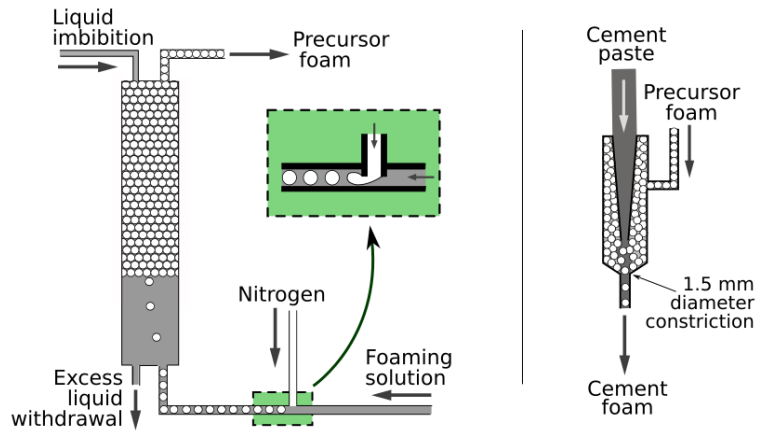

Figure 3: Schema of precursor foam generation (left) and mixing device (right)

133 For each cement foam sample, we fill both the rheometer cup for yield stress  
 134 or elasticity measurement and a mold for stability assessment.

#### 135 2.2.4. Final stability

136 Samples are casted in 6 cm high 2.6 cm-diameter air-tight plastic cylinders.  
 137 We checked that foams do no break when they are in contact with the mold  
 138 walls. Samples are demolded 7 days after casting. Cement foam stability is  
 139 assessed visually and samples are classified within the five categories illustrated  
 140 in Fig. 4:

- 141 • 3: fully stable sample
- 142 • 2: large stable area
- 143 • 1: small stable area(s)
- 144 • 0: no stable area
- 145 • -1: sample collapse

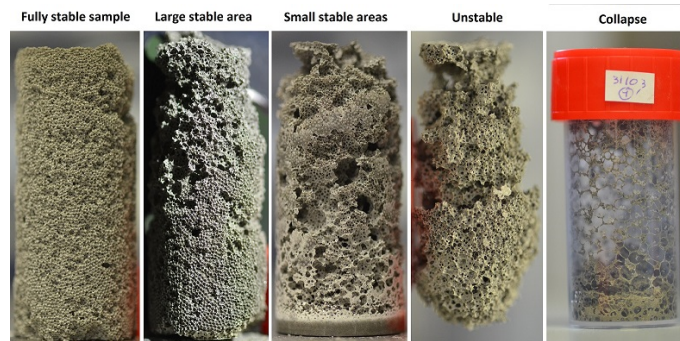

Figure 4: Example of samples illustrating each stability class. Sample height is 6 cm.

146 It can be noted that the final stability is the result of many competing  
 147 phenomena including the intrinsic stability of the foam and the time during  
 148 which the foam is exposed to destabilisation. This time relates to the setting  
 149 time of the system.

#### 150 2.2.5. Rheometry

151 We use a stress controlled rheometer Malvern Kinexus Ultra+ with a Vane  
 152 geometry in a striated (to avoid wall-slip) cylindrical cup of diameter 37 mm.  
 153 The six-blade Vane tool is 5 cm high and 25 mm large. Each measurement  
 154 sequence starts with stress relaxation during 30 s. Then, either yield stress  
 155 is measured with a start-of-flow curve at a shear rate of  $0.01 \text{ s}^{-1}$ , or elastic  
 156 modulus is monitored with  $10^{-5}$  oscillations at 1 Hz.

157 This strain value is well below both critical strains related to flocculation  
 158 and formation of CSH bridges between cement grains [13]. Therefore, we expect  
 159 that elasticity measurement does not affect thixotropic behavior of the cement  
 160 paste and is, as such, a non-destructive measurement.

#### 161 2.2.6. Water suction out of the cement pastes

162 We measure the ability of the reference cement paste to release water by  
 163 using the experimental device schematized in Fig. 5. A 1.6-cm thick layer of

164 reference cement paste containing Steol surfactant is placed on one side of a  
 165 U-shaped tube filled with water. A filter ( $0.45\ \mu\text{m}$ ) separates the cement paste  
 166 and the tube. It can be crossed by the water but not by the cement grains.  
 167 The surface of water in the other branch of the tube is free to move. When  
 168 the cement paste is raised above the free water surface at height  $h$ , a pressure  
 169 difference  $\Delta P = \rho_{liq}gh$  is created at the bottom of the cement paste. The  
 170 volume of extracted water can then be deduced from the displacement of the  
 171 free water surface in the tube. Note that  $h$  decreases during the time of the  
 172 experiment because water extraction makes the free water surface rise. For each  
 173 experiment, the initial pressure is  $\Delta P = 440\ \text{Pa}$  and it decreases down to a value  
 174 comprised between 400 and 375 Pa after 10 minutes. The value chosen for  $\Delta P$   
 175 accounts for the hydrostatic pressure in the continuous phase in the 6-cm high  
 176 foam samples described in paragraph 2.2.4 (where the pressure varies between  
 177 0 and 600 Pa).

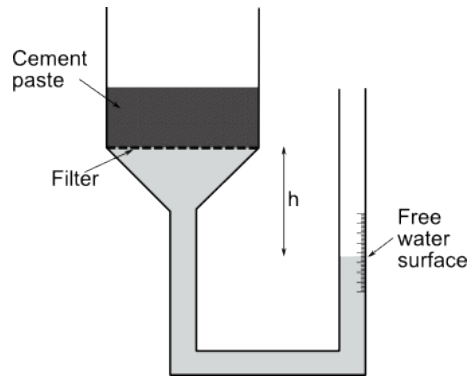

Figure 5: Experimental device used to measure the water volume extracted from the reference cement pastes at  $\Delta P \simeq 440\ \text{Pa}$ .

### 178 2.3. Cement paste yield stress

179 To measure the reference cement paste yield stresses, noted  $\tau_{y,0}$ , a volume  
 180  $\Omega$  (30 mL on average) of each paste is poured on a flat surface and the resulting

181 average radius  $R_{spread}$  is measured.  $\tau_{y,0}$  is then obtained from the paste density  
 182  $\rho$  and the poured volume  $\Omega$  with the following formula [14]:

$$\tau_{y,0} = \frac{225\rho g\Omega^2}{128\pi^2 R_{spread}^5} \quad (1)$$

183 Equation 1 is valid at intermediate yield stress values. On the one hand, it  
 184 must be high compared to capillary forces and, on the other hand, the sample  
 185 thickness must be small compared to its radius. As already discussed in [11],  
 186 capillary forces can be neglected when yield stress is above 1 Pa. We choose to  
 187 set all the values measured below 1 Pa to  $\tau_{y,0} = 1$  Pa. Regarding the second  
 188 condition, the maximal measured value is  $\tau_{y,0} \simeq 100$  Pa: in this case, the ratio  
 189 of the spread radius on the spread height is 3.

190 Measured values for the reference cement paste yield stresses  $\tau_{y,0}$  are given  
 191 in Fig. 6. Two water-to-cement ratios  $W/C_f = 0.38$  and  $0.41$  have been studied  
 192 in the case of Steol surfactant, whereas only  $W/C_f = 0.36$  has been considered  
 193 in the case of Tempo 12 and Triton mixes.

194 For the sake of simplicity, we choose here to interpolate our results with an  
 195 exponential function as this mathematical form seems to fit our data over the  
 196 range of our experiments. Therefore, in the following, we will use the following  
 197 equations to estimate, when required, the reference cement paste yield stress  
 198  $\tau_{y,0}$  from the Steol or Tempo 12 concentrations  $C_{Steol}$  or  $C_{Tempo\ 12}$  (with yield  
 199 stresses in Pa and concentrations in g/L):

- 200 •  $\tau_{y,0} = 6.87 \cdot 10^9 e^{-1.89 C_{Steol}}$  with Steol and  $W/C_f=0.41$ ,
- 201 •  $\tau_{y,0} = 8.30 \cdot 10^{12} e^{-1.97 C_{Steol}}$  with Steol and  $W/C_f=0.38$ ,
- 202 •  $\tau_{y,0} = 137 e^{-0.191 C_{Tempo\ 12}}$  with Tempo 12 and Triton.

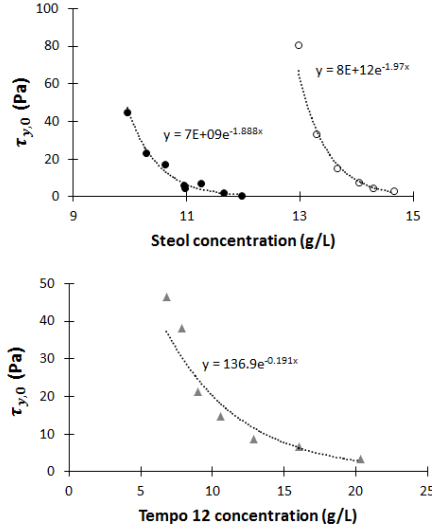

Figure 6: Yield stresses of reference cement pastes prepared following the same protocol as cement foam. Top: pastes containing Steol anionic surfactant with  $W/C_f=0.38$  (empty dots) and  $W/C_f=0.41$  (full dots). Bottom: superplasticizer and Triton non-ionic surfactant with  $W/C_f=0.36$ .

### 203 3. Results

#### 204 3.1. Stability

205 Fig. 7 illustrates a typical time evolution of an unstable foam. Pictures are  
 206 taken through the transparent mold, thus, note that we can see only the mor-  
 207 phology of the side of the sample against the mold walls, where the movement  
 208 of the bubbles deposits a cement layer. Therefore, the morphology of the foam,  
 209 as seen at the wall after destabilization, may not be representative of the bulk  
 210 morphology. However, we can neatly see that major change of the foam struc-  
 211 ture takes place before 30 min after sample preparation. This is true for all  
 212 unstable samples, where destabilization always starts to occur before 30 min.

213 The stability of cement foams samples containing either anionic or non-ionic  
 214 surfactant is plotted in figure 8 as a function of the reference cement paste yield  
 215 stress  $\tau_{y,0}$ .

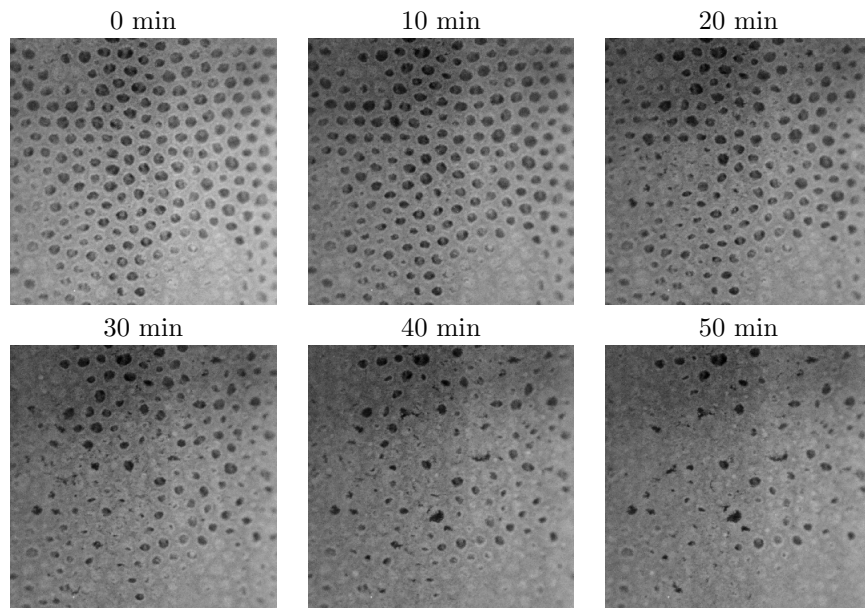

Figure 7: Typical time evolution of an unstable cement foam ( $W/C_f = 0.41$ ,  $10.2 \text{ g/L}$  of Steol,  $\tau_{y,0} = 18 \text{ Pa}$ ). Foam on the pictures is seen through the transparent mold ; note that the movement of the bubbles deposits a cement layer on the mold walls and that apparent morphology after foam destabilization may not be representative of the bulk morphology of the foam. Cement paste is in light grey and bubbles are black. Picture width is 1 cm.

216 In all cases, best foam stability is obtained at moderately low reference ce-  
 217 ment paste yield stress. On the one hand, foams are unstable at high  $\tau_{y,0}$ , i.e.  
 218 above a critical value  $\tau_{y,0}^* \simeq 10 \text{ Pa}$ . The increase of  $\tau_{y,0}$  above  $\tau_{y,0}^*$  leads con-  
 219 sistently to unstable foams. This behavior is particularly noticeable in Tempo  
 220 12 - Triton foams, where foam collapse was observed for reference cement paste  
 221 yield stress close to 25 Pa. On the other hand, very low reference cement paste  
 222 yield stress values, below  $\tau_{y,0}^{**} \simeq 2 \text{ Pa}$ , also lead to unstable foams. In this very  
 223 low reference cement paste yield stress regime, reproductibility of the results is  
 224 poor. Foams with the same formulation can sometimes have different stability  
 225 behaviors.

226 These stability results are unexpected, because, as mentioned in the intro-  
 227 duction, high interstitial yield stress is expected to stop drainage and ripening.

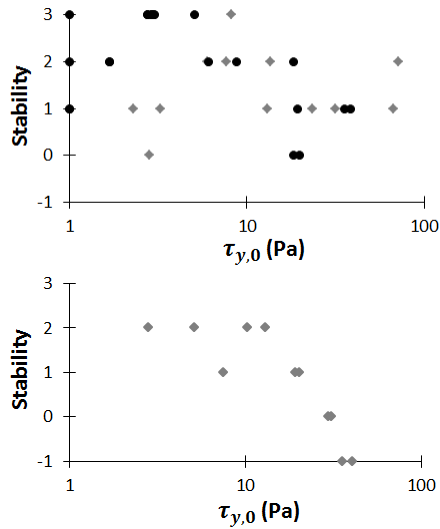

Figure 8: Top: Stability of cement foams containing Steol anionic surfactant. Grey diamonds correspond to foams made with initial  $W/C_f=0.38$  and black dots to foams with  $W/C_f=0.41$ . Bottom: Stability of cement foams containing superplasticizer and Triton.

228 These puzzling results can be due to several effects including:

- 229
- 230 • The cement paste inside the foam structure may have a different behavior than the unfoamed reference cement paste.
  - 231 • Time related effects, i.e. thixotropy and hydration kinetics, may play a
  - 232 significant role.

233 In the next paragraph, rheological investigation is used to elucidate these

234 points. Foam yield stress measurement at early age is used to assess the behavior

235 of the interstitial cement paste. Then, as a non-destructive measurement, elastic

236 modulus is monitored to evaluate the time evolution of the paste rheological

237 properties. Besides, segregation of water and cement grains are measured by

238 the water suction experiment.

239 *3.2. Rheological measurements*

240 *3.2.1. Foam yield stress*

241 We notice that two types of start-of-flow curve shape were obtained for fresh  
242 cement foams. Examples for both curve shapes are shown in figure 9. For some  
243 samples, the stress increases up to a plateau value. For other samples, plateau  
244 value is lower than the stress at the peak and the curve exhibits an overshoot.  
245 In both cases, yield stress  $\tau_{y,foam}$  is obtained for shear strains between 40 and  
246 75%.

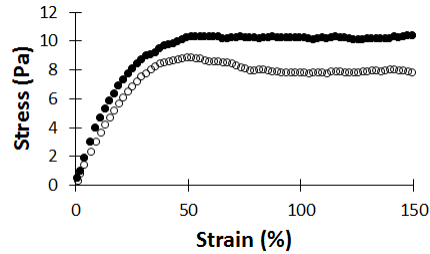

Figure 9: Examples of the two types of start-of-flow curves. Both curves were obtained for samples with  $W/C_f=0.41$ , for two different Steel concentrations. Curve with overshoot (empty circles) is obtained with 11.4 g/L of Steel and  $\tau_{y,0} = 3$  Pa, and curve without overshoot (black dots), with 10.4 g/L of Steel and  $\tau_{y,0} = 18$  Pa.

247 Foam yield stress,  $\tau_{y,foam}$ , for all the samples is plotted as a function of the  
248 reference cement paste yield stress  $\tau_{y,0}$  in Fig. 10. The presence of an overshoot  
249 is indicated by empty dots and diamonds.

250 For the three sets of results,  $\tau_{y,foam}$  increases with  $\tau_{y,0}$  but the foam yield  
251 stress variation is limited: while  $\tau_{y,0}$  ranges from about 1 to 100 Pa, the foam  
252 yield stress varies from 6 Pa to 14 Pa. Besides, overshoot occurs when  $\tau_{y,0} \leq \tau_{y,0}^*$ .

253 *3.2.2. Elasticity*

254 Two different types of elastic modulus evolution are shown in figure 11.  
255 Curve slope can either be constant during 50 min or decrease with time.



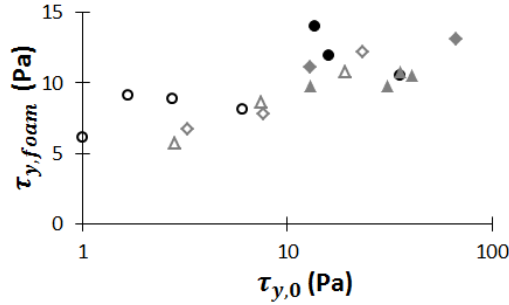

Figure 10: Macroscopic yield stress of fresh cement foam. Black dots refer to cement pastes containing anionic surfactant at  $W/C_f = 0.41$  and grey diamonds at  $W/C_f = 0.38$ . Grey triangles refer to samples with superplasticizer and non-ionic surfactant. Empty symbols refer to curves where an overshoot was observed.

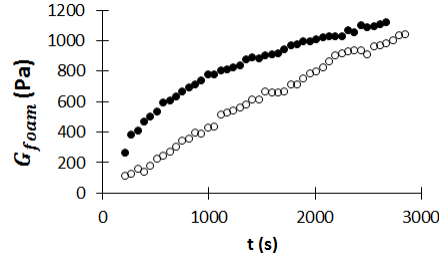

Figure 11: Examples of the two possible shapes of elastic modulus curves. Both curves were obtained for samples containing Steol surfactant with  $W/C_f=0.41$ . Linear curve (empty circles) is obtained with 11.4 g/L of Steol and  $\tau_{y,0} = 3$  Pa, and non-linear curve (black dots), with 10.4 g/L of Steol and  $\tau_{y,0} = 18$  Pa.

256 Values for the elastic modulus at  $t=0$  and  $t=40$  min are plotted as a function  
 257 of  $\tau_{y,0}$  in Fig. 12. As expected, the higher  $\tau_{y,0}$ , the higher the initial elastic  
 258 modulus. When reference cement paste yield stress increases by two decades,  
 259 the foam elastic modulus is increased by a factor 4. However, 40 minutes after  
 260 the start of the oscillation test, the foam elastic modulus hardly increases with  
 261 reference cement paste yield stress anymore.

262 From Fig. 12, we note that only samples with low  $\tau_{y,0}$  correspond to samples  
 263 characterized by a linear increase of the foam elastic modulus as a function time.

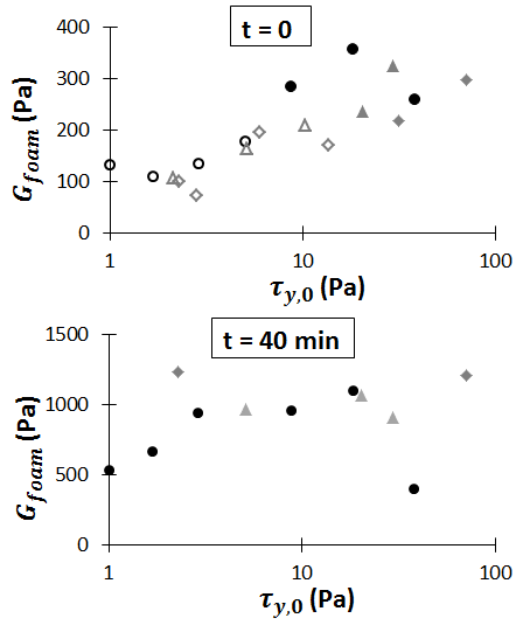

Figure 12: Elastic modulus of fresh cement foam at  $t=0$  and  $t=40$  min. Black dots refer to cement pastes containing anionic surfactant at  $W/C_f = 0.41$  and grey diamonds at  $W/C_f = 0.38$ . Grey triangles refer to samples with superplasticizer and non-ionic surfactant. In first graph, empty symbols refer to linear elastic modulus curves.

### 264 3.3. Water suction

265 Fig. 13 shows the percentage of water extracted from the reference cement  
 266 pastes containing Steel at  $W/C_f = 0.41$ . We note that the amount of extracted  
 267 water decreases when  $\tau_{y,0}$  increases, mainly when  $\tau_{y,0} > \tau_{y,0}^*$ . Below  $\tau_{y,0}^*$ , the  
 268 volume ratio between the extracted water and the initial water is of the order  
 269 of 15%.

## 270 4. Discussion

### 271 4.1. Comparison with simple aqueous foams

272 Aqueous foams are known to behave like an elastic solid at small defor-  
 273 mations and to exhibit a yield stress at higher deformation. Their rheological

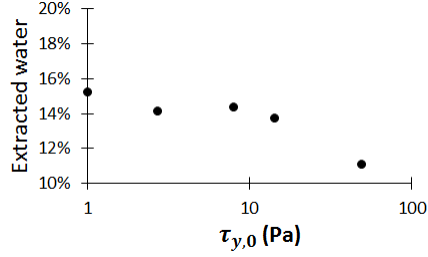

Figure 13: Ratio of extracted water (i.e the volume of extracted water to the initial water volume) from reference cement pastes at  $W/C_f = 0.41$  containing Steol surfactant after 10 minutes at  $\Delta P \simeq 400$  Pa

274 properties depend on the bubble radius  $R$ , the surface tension  $\gamma$  and the gas  
 275 volume content  $\Phi$ . Their yield stress is given by equation 2 [15, 16] and their  
 276 elastic modulus by equation 3 [4].

$$\tau_{y,aq}(\Phi) = 0.6 \frac{\gamma}{R} (\Phi - \Phi_c)^2 \quad (2)$$

$$G_{aq}(\Phi) = 1.4 \frac{\gamma}{R} \Phi (\Phi - \Phi_c) \quad (3)$$

277 where  $\Phi_c$  is the critical packing volume fraction above which there are films  
 278 between the bubbles and equals 0.64 in the case of disordered monodisperse  
 279 foam.

280 To estimate both  $\tau_{y,aq}$  and  $G_{aq}$  the surface tension of bubbles  $\gamma$  must be  
 281 known. By considering the results published in [11] for the surface tension of  
 282 cement pore solutions, we use  $\gamma = 35$  mN/m for both Steol or Triton foams.

283 Therefore, using equations 2 and 3, the aqueous foam yield stress for both  
 284 surfactants is  $\tau_{y,aq}(83\%) \simeq 2$  Pa and the elastic modulus is  $G_{aq}(83\%) \simeq 20$  Pa.  
 285 Both are significantly below the values measured with the cement foams samples  
 286 for all  $\tau_{y,0}$ . This means that the interstitial cement paste strongly enhances the  
 287 foam rheological properties, even when the reference cement paste yield stress

288  $\tau_{y,0}$  is very low.

#### 289 4.2. Early age rheological properties

290 Let us first discuss the presence of the overshoot when  $\tau_{y,0} < \tau_{y,0}^*$ . This over-  
291 shoot is not expected to result directly from thixotropy effects [13] in the cement  
292 paste, as they appear only for low reference cement paste yield stress, that is  
293 to say, for the highest concentrations of anionic surfactant or superplasticizer.  
294 Indeed, apparent thixotropy in cement paste arises from two effects: creation  
295 of a percolated network of colloidal cement grains during the first seconds af-  
296 ter high shear mixing, then nucleation and growth of CSH bond between the  
297 grains [13]. Our yield stress measurements are carried out only a few minutes af-  
298 ter the foam production, so the major contribution to the measured yield stress  
299 is the colloidal percolation network. As attraction forces between cement grains  
300 are reduced in the presence of high amount of Steol [11] or superplasticizer [10]  
301 due to steric repulsion, the colloidal network is not expected to be stronger or  
302 to form faster in the case of deflocculated pastes.

303 We stress here that the start-of-flow curve of granular material exhibits an  
304 overshoot when grains are densely packed [17, 18]. Moreover, *Gorlier et al.* [19]  
305 studied start-of-flow curves of complex fluid foams. They showed that there  
306 is no overshoot when the interstitial fluid is a simple yield stress fluid (i.e.  
307 concentrated emulsion for example), whereas overshoot appears when aqueous  
308 foam is mixed with small beads suspension. The authors analyzed the stresses  
309 at stake in the granular foam and concluded that small particles packed in the  
310 foam structure behave as dense granular matter.

311 The yield stress of foams made with a yield stress fluid (characterized by a  
312 yield stress value  $\tau_{y,int}$ ) has been shown to be described by equation 4, provided  
313 that  $\tau_{y,int}R/\gamma < 0.5$  [19].

$$\frac{\tau_{y,foam}(\Phi)}{\tau_{y,aq}(\Phi)} = 1 + c(1 - \Phi)^{4/3} \left( \frac{\tau_{y,int} R}{\gamma} \right)^{2/3} \quad (4)$$

314 where  $c = 110$  is a fitting parameter. Using equation 4, we deduce the yield  
 315 stress of the interstitial cement paste  $\tau_{y,int}$  from the measured foam macro-  
 316 scopic yield stress  $\tau_{y,foam}(\Phi)$  (plotted in Fig. 10).  $\tau_{y,int}$  is plotted in Fig. 14  
 317 against the reference cement paste yield stress  $\tau_{y,0}$ . This graph shows that,  
 318 when the cement paste yield stress is high, i.e. above 20 Pa, the interstitial  
 319 yield stress is equal to the reference cement paste yield stress. On the other  
 320 hand, when the reference cement paste yield stress is lower,  $\tau_{y,int}$  is strongly  
 321 enhanced, up to a factor 10.

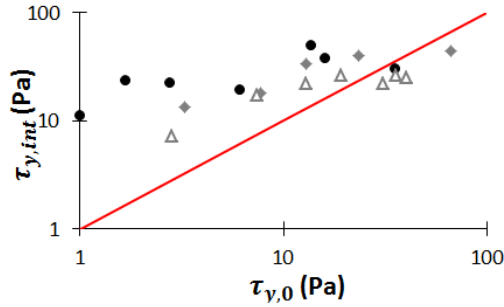

Figure 14: Comparison of yield stress of identical cement pastes when they are confined in the foam  $\tau_{y,int}$  and with no foam  $\tau_{y,0}$ . Black dots refer to cement pastes containing anionic surfactant at  $W/C_f = 0.41$  and grey diamonds at  $W/C_f = 0.38$ . Grey triangles refer to samples with superplasticizer and non-ionic surfactant.

322 To summarize, the start-of-flow curve shape (Fig. 9) and interstitial yield  
 323 stress curves (Fig. 14) allow us to identify two rheological behaviors of the  
 324 cement paste in the foam:

- 325 • When  $\tau_{y,0} > \tau_{y,0}^*$ , the cement paste acts as a classical yield stress fluid, i.e.  
 326 the measured value for the interstitial yield stress is close the yield stress  
 327 of the reference cement paste. In this regime, that we call *yield stress*  
 328 *regime*, cement foams are unstable within our experimental conditions.

329 • When  $\tau_{y,0} < \tau_{y,0}^*$ , the cement paste behaves as a confined granular mate-  
 330 rial. An overshoot appears on the start-of-flow curve of the cement foam  
 331 and the interstitial yield stress is significantly increased with respect to  
 332 the reference cement paste yield stress. This regime, that we call *granular*  
 333 *regime*, because it is reminiscent of the behavior of confined granular pack-  
 334 ing, allows for significant foam stability. The stability loss at the lower  
 335 reference cement paste yield stresses will be discussed in part 4.4.

336 For the *granular regime* to appear, the cement grains packing must become  
 337 denser, i.e. excess water must be removed. Estimation of the ability of cement  
 338 paste to loose this excess water due to gravity effect is assessed by the water  
 339 extraction curve. In Fig. 15, we observe that, for a reference cement paste  
 340 characterized by a water-to-cement ratio  $W/C_f=0.41$ ,  $W/C$  reaches 0.35 when  
 341  $\tau_{y,0} < \tau_{y,0}^*$ . On the other hand, in the *yield stress regime*,  $W/C$  remains above  
 342 0.36. This observation tends to confirm that, thanks to grains rearrangement, a  
 343 denser granular network can be set up more easily when  $\tau_{y,0} < \tau_{y,0}^*$  than when  
 344  $\tau_{y,0} > \tau_{y,0}^*$ . In cement foams, removal of water from the interstitial cement paste  
 345 by drainage leads to an increase of its solid volume content  $\Phi_p$ . We recall that  
 346 the yield stress of a solid suspensions is related to the interaction between the  
 347 solid particles and the solid volume content [8]. At given interaction intensity,  
 348 the yield stress increases when the solid volume content increases. Therefore,  
 349 water extraction due to drainage can account for the increase of  $\tau_{y,int}$ .

350 Let us estimate the amount of water which must drain from the cement foams  
 351 when water-to-cement ratio of the interstitial cement paste decreases from 0.41  
 352 to 0.35. Corresponding solid volume content in the cement paste is given by  
 353  $\Phi_p = (1 + \rho_c/\rho_{liq}W/C)^{-1}$ ; that is to say that  $\Phi_p$  increases from 0.43 to 0.47.  
 354 Water loss is therefore  $(0.47 - 0.43)/0.47 = 8.5\%$  of the paste volume, i.e. 2%  
 355 of the foam volume, which cannot be visually observed with our samples.

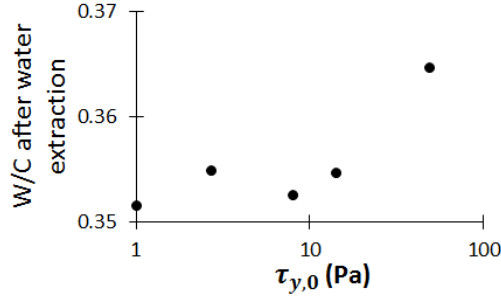

Figure 15: Ratio of extracted water from reference cement pastes at  $W/C_f = 0.41$  containing Steol surfactant after 10 minutes at  $\Delta P \simeq 400$  Pa

356 When  $\tau_{y,0} < \tau_{y,0}^*$ , granular effect can account for the increase of the yield  
 357 stress of the interstitial cement paste due to the confinement provided by the  
 358 bubble interface. However, interstitial yield stress is still smaller in the *granular*  
 359 *regime* than in the *yield stress regime*, so other effects are involved in the re-  
 360 markable stability observed in the *granular regime*. One hypothesis to explain  
 361 this stability is that the time evolution of the interstitial cement paste rheo-  
 362 logical properties plays a role on foam stability. This issue is discussed in the  
 363 following paragraph.

#### 364 4.3. Time evolution of rheological properties

365 Similarly to what we have done for  $\tau_{y,int}$ , we can estimate the interstitial elas-  
 366 tic modulus  $G_{int}$  from the measured value of the foam elastic modulus  $G_{foam}$ .  
 367 The equation and the results are given and discussed in Appendix A. However,  
 368 the interstitial elastic modulus, up to 40 min after foam preparation, cannot  
 369 explain the remarkable stability of the foams in the *granular regime*.

370 Therefore, to further investigate the effect of foam aging, we measure the  
 371 evolution of the interstitial yield stress with time. Whereas the elastic modulus  
 372 is measured at low deformation, below 0.1%, the yield stress is obtained at high  
 373 shear strain. Consequently, elasticity and yield stress measured in cement paste

374 have different origins [13]: the elasticity is caused only by the hydrates bonds  
375 between cement grains, whereas the yield stress results from both colloidal inter-  
376 action and hydrate bonds. Second consequence of the high sample deformation  
377 during start-of-flow experiment is that this measurement is destructive: yield  
378 stress for each age must be measured with a different sample. Each sample is  
379 prepared following the same protocol as described in 2.2.1 and placed in the  
380 rheometer geometry. Then a resting time between 0 and 45 min is chosen be-  
381 fore the start of the yield stress measurement. Measured values for  $\tau_{y,int}$  are  
382 shown in Fig. 16. The curve shape in *yield stress regime* is typical for cement  
383 paste [13] and exhibits a two-regime behavior with two different slopes: in the  
384 first regime, the yield stress growth is governed by the colloidal interactions  
385 between the cement grains, and, in the second regime, formation of hydrates  
386 bonds become predominant.

387 For the stable foam in the *granular regime*, a very fast increase occurs during  
388 the first minutes of rest. 15 minutes after the start of the experiment,  $\tau_{y,int}$  is two  
389 times larger than the value obtained in the *yield stress regime* and it appears to  
390 be able to prevent the foam destabilization. The curve shows that the drainage  
391 of the water from the interstitial cement paste, which is expected to induce the  
392 observed increase of  $\tau_{y,int}$  within the granular regime, has not fully occurred  
393 when the initial rheological properties of the foams are measured (at  $t=0$ ), but  
394 it seems completed after 15 min. After 15 minutes, both interstitial yield stress  
395 curves have the same slope, which shows that there is no major difference of  
396 chemical activity, and hence of hydrates nucleation, between the two types of  
397 samples.

398 When drainage is completed, i.e. after about 15 min, the value of  $\tau_{y,int}$   
399 obtained in the *granular regime* is about 100 Pa. Note that this value is of the  
400 same order of magnitude as the interstitial yield stress obtained for foams made



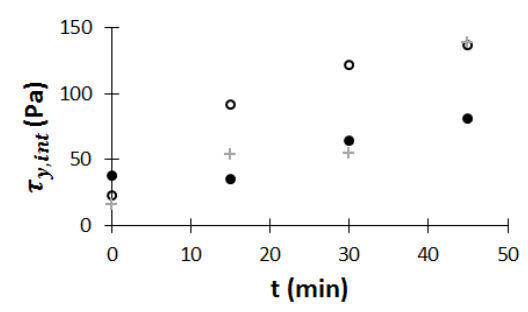

Figure 16: Increase of interstitial yield stress with time for cement foams  $W/C_i = 0.35$  containing Steol. Full dots to foams in the colloidal regime (Steol concentration 10.4 g/L,  $\tau_{y,0} = 18$  Pa), empty dots refer to very stable foams in the granular regime (Steol concentration 11.4 g/L,  $\tau_{y,0} = 3$  Pa) and grey crosses to less stable foams in the granular regime (Steol concentration 12.3 g/L,  $\tau_{y,0} < 1$  Pa)

401 with non-colloidal monodisperse spherical particles (diameter 10 or 20  $\mu\text{m}$ ) [19],  
 402 i.e. 120 Pa. This confirms that the interstitial cement paste in the *granular*  
 403 *regime* behaves in a similar manner as a suspension of particles with very low  
 404 attractive interactions.

#### 405 4.4. Stability loss at very high surfactant content

406 The last point that remains to be discussed is the stability loss observed for  
 407 Steol foams when  $\tau_{y,0} < \tau_{y,0}^{**}$ . The evolution of  $\tau_{y,int}$  for a foam where  $\tau_{y,0} <$   
 408 1 Pa is plotted in Fig. 16. The increase of  $\tau_{y,int}$  before 15 min is smaller than  
 409 in the stable foam, but higher than in the case  $\tau_{y,0} > \tau_{y,0}^*$ .

410 A first hypothesis to explain this stability loss is a delay of hydration. Indeed,  
 411 some authors [20] have observed that some surfactants, at high concentrations,  
 412 delay hydration. This is confirmed for Steol in Fig. 17. However, as mentioned  
 413 in the previous paragraph, the influence of hydration kinetics on cement foam  
 414 stability appears to be minor compared to the early age structuration of the  
 415 cement paste into a dense granular packing or colloidal network.

416 Therefore, the most probable explanation for the observed unstability when  
 417  $\tau_{y,int} < \tau_{y,int}^{**}$  is that drainage of the cement paste can occur between the bub-

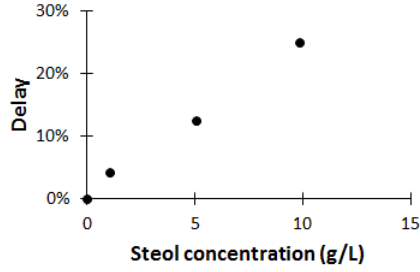

Figure 17: Delay of hydration of cement pastes containing Steol. The paste are prepared following the same protocol as described in [11], i.e. water-to-cement ratio is 0.5 and cement is a CEM I cement from St Vigor factory, Lafarge. We measure the evolution of temperature in the cement paste after water and cement mixing and the delay of hydration  $\Delta$  is calculated from the time  $t_{peak}$  when the maximum temperature is measured, with the formula:  $\Delta = (t_{peak} - t_{peak,ref})/t_{peak,ref}$ .  $t_{peak,ref} = 12 h$  is the reference time in sample containing no surfactant.

418 bles. Indeed, a layer of cement can often be seen at the bottom of the highly  
 419 deflocculated cement foam sample. The flow of a yield stress fluid in the foam  
 420 channels, called Plateau borders, and nodes can be compared to the flow of a  
 421 fluid in a porous medium. In such a case, the gravity-induced flow is expected  
 422 to occur if the yield stress is below a critical value  $\tau_{c,d}$  with depends on the pore  
 423 radius  $a$  [21]:

$$\tau_{c,d} \simeq \rho g a \quad (5)$$

424 In the case of a foam, we can assume that the equivalent pore size is repre-  
 425 sented by the size of the bigger spheres which can pass in the plateau borders.  
 426 The corresponding radius is given by [22]:

$$r_{PB} = R \frac{0.27\sqrt{1-\Phi} + 3.17(1-\Phi)^{2.75}}{1 + 0.57(1-\Phi)^{0.27}} \quad (6)$$

427 When  $R=390 \mu\text{m}$  and  $\Phi = 83\%$ , equation 6 gives  $r_{PB} = 40 \mu\text{m}$ . Therefore,  
 428 equation 5 gives  $\tau_{c,d} \sim 1 Pa$ , which is in agreement with our observation that  
 429 the drainage occurs when  $\tau_{y,0} < \tau_{y,0}^{**} = 1 Pa$ .

430 Note that drainage in the Plateau borders and nodes may induce a segrega-  
431 tion of the cement grains in the very deflocculated cement pastes. The diameter  
432 of the biggest sphere that can pass in the Plateau borders is  $2r_{PB}=80 \mu\text{m}$ ,  
433 which is close to the size of the bigger cement grains. Therefore, while big  
434 cement grains are potentially retained by the foam nodes and channels, small  
435 grains can escape the structure and settle at the sample bottom. This leads to  
436 a less dense granular packing and a decreased interstitial yield stress.

## 437 5. Conclusion

438 We have studied the capacity of cement pastes for producing morphology-  
439 controlled cement foams. By using two distinct additives, our experimental  
440 approach allowed us to tune finely the reference cement paste yield stress (i.e.  
441 the yield stress of the unfoamed cement paste with the same water and additives  
442 content as the cement foam), while keeping constant several control parameters,  
443 namely the W/C ratio, the bubble size and the gas volume fraction. Our results  
444 reveal an unexpected effect of the reference cement paste yield stress on cement  
445 foam stability.

446 When the reference cement paste yield stress value is high, i.e. above 10 Pa,  
447 cement foams were found to evolve significantly before setting, leading to un-  
448 controlled final morphology. In such a case we have shown that the interstitial  
449 cement paste behaves as a “classical” yield stress material with effective yield  
450 stress value equal to the yield stress of the reference cement paste. Note that  
451 within our experimental conditions, all studied reference cement paste yield  
452 stress values were below 100 Pa. We anticipate that larger values should allow  
453 for a control of the final morphology.

454 For lower reference cement paste yield stress values, remarkable morpholog-  
455 ical control can be achieved. This result is attributed to the additives-induced

456 reduction of attractive van der Waals interactions: weak attractive forces allow  
457 for the densification of the cement grains within the foam network as well as the  
458 simultaneous drainage of the excess interstitial pore solution. The combination  
459 of these effects has been proved to enhance drastically the effective yield stress  
460 property of the interstitial cement paste, resulting in efficient immobilization of  
461 fresh foams, without resorting to set accelerators. Such a mechanical behavior  
462 is reminiscent of aqueous foams made with granular matter, i.e. grains without  
463 any other interaction than contacts, as studied recently by *Gorlier et al.* [19].  
464 This result shows that, in practice, stable cement foams can be produced when  
465 cement paste yield stress is low. We anticipate that the drainage of the excess  
466 interstitial pore solution could be critical if the drained volume is large, i.e. for  
467 large W/C ratios or important foam heights.

468 Finally, we show that, when the reference cement paste yield stress is very  
469 low, poor control of the foam morphology is achieved. This result is attributed  
470 to the deflocculated state of cement colloidal particles in this regime: defloc-  
471 culated small cement particles exit the foam skeleton along with the draining  
472 pore solution so the above-described densification mechanism is prevented from  
473 occurring.

474 All these results are obtained with a constant bubble radius ( $390 \mu\text{m}$ ). A  
475 decrease of the bubble radius (i.e. a decrease of Plateau border size) is expected  
476 to better prevent the loss of cement grains from the interstitial cement paste.  
477 This would benefit to stability at very low reference cement paste yield stress.  
478 However, it would also increase ripening velocity [4]. Therefore, to understand  
479 the effect of bubble size on cement foam stability, the destabilization mechanisms  
480 at stake must be identified. This issue will be addressed in a further study.

481 **Acknowledgments**

482 The authors wish to thank David Hautemayou and Cédric Mézières for tech-  
 483 nical support. This work has benefited from two French government Grants  
 484 managed by the Agence Nationale de la Recherche [Grants number ANR-11-  
 485 LABX-022-01 and ANR-13-RMNP-0003-01].

486 **Appendix A: Interstitial elastic modulus at 40 min.**

487 The foam elastic modulus  $G_{foam}$  can be considered as the sum of the con-  
 488 tribution of the aqueous foam  $G_{aq}$ , and a contribution which depends on the  
 489 interstitial elastic modulus  $G_{int}$  [23, 24]:

$$G_{foam} = G_{aq} + G_{int}(1 - \Phi)^2 \left( 1 + 15(2\Phi - 1) \left( \frac{\gamma}{RG_{int}} \right)^{2/3} \right) \quad (7)$$

490 Equations 3 and 7 allow us to assess  $G_{int}$  at several times, as shown in  
 491 Fig. 18 for  $t=40$  min.

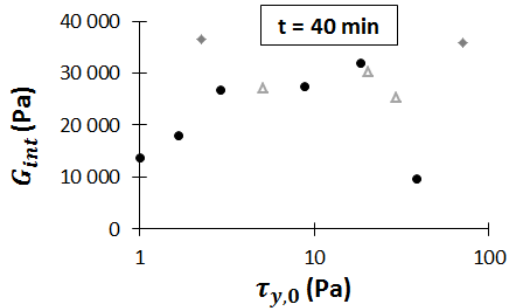

Figure 18: Interstitial elastic modulus at time  $t=40$  min. Black dots refer to cement pastes containing anionic surfactant at  $W/C_f = 0.41$  and grey diamonds at  $W/C_f = 0.38$ . Grey triangles refer to samples with superplasticizer and non-ionic surfactant.

492 We see that the increase of  $G_{int}$  is faster in the *granular regime* than in  
 493 the *yield stress regime*. Though, the elastic modulus remains higher in most of  
 494 the *yield stress*-type foams than in the *granular regime* until 40 minutes. At

495 this time, as shown in Fig. 7, ripening has already started to occur in unstable  
496 foams. Therefore, the values of  $G_{int}$  up to 40 minutes after foam production  
497 cannot account for the better stability observed in the *granular regime*.

498 Regarding the shape of the curves of the elastic modulus as a function of  
499 time, we note that for foams in the *granular regime*, the slope of foam elastic  
500 modulus curve is constant. This linear increase at low amplitude oscillations is  
501 a typical evolution for cement pastes and it is known to result from the constant  
502 volume formation rate of hydrates between the cement grains [13]. In the *yield*  
503 *stress regime*, however, elastic modulus slope becomes smaller with time. We  
504 can assume that this is a consequence of the foam destabilisation: the slow  
505 shearing induced by the bubbles deformation during destabilization leads to a  
506 partial rejuvenation of the cement paste and partially compensates the increase  
507 of elasticity caused by thixotropy [13].

## 508 References

- 509 [1] G. Samson, A. Phelipot-Mardelé, C. Lanos, Thermal and mechanical prop-  
510 erties of gypsum-cement foam concrete: effects of surfactant, Journal of  
511 Environmental and Civil Engineering 21 (12) (2016) 1502–1521.
- 512 [2] M. T. Hoang, C. Perrot, Solid films and transports in cellular foams, Jour-  
513 nal of Applied Physics 112 (2012) 054911.
- 514 [3] V. Langlois, V. H. Trinh, C. Lusso, C. Perrot, X. Chateau, Y. Khidas,  
515 O. Pitois, Permeability of solid foam: Effect of pore connections, Physical  
516 Review E 97 (2018) 053111.
- 517 [4] I. Cantat, S. Cohen-Addad, F. Elias, F. Graner, R. Höhler, O. Pitois,  
518 F. Rouyer, A. Saint-Jalmes, Foams - Structure and dynamics, Oxford Uni-  
519 versity Press, 2013.

- 520 [5] S. Guignot, S. Faure, M. Vignes-Adler, O. Pitois, Liquid and particles  
521 retention in foamed suspensions, *Chemical Engineering Science* 65 (2010)  
522 2579–2585.
- 523 [6] I. Lesov, S. Tcholakova, N. Denkov, Factors controlling the formation and  
524 stability of foams used as precursors of porous materials, *Journal of Colloid  
525 and Interface Science* 426 (2014) 9–21.
- 526 [7] I. Lesov, S. Tcholakova, N. Denkov, Drying of particle-loaded foams for  
527 production of porous materials: mechanism and theoretical modeling, *RSC  
528 Advances* 4 (2014) 811–823.
- 529 [8] R. J. Flatt, P. Bowen, Yodel: a yield stress model for suspensions, *Journal  
530 of the American Ceramic Society* 89 (4) (2006) 1244–1256.
- 531 [9] G. Gelardi, R. J. Flatt, Working mechanisms of water reducers and super-  
532 plasticizers, in: P.-C. Aïtcin, R. J. Flatt (Eds.), *Science and technology of  
533 concrete admixtures*, Woodhead publishing, 2016, pp. 257–278.
- 534 [10] R. J. Flatt, I. Schober, Superplasticizer and the rheology of concrete, in:  
535 N. Roussel (Ed.), *Understanding the rheology of concrete*, Woodhead pub-  
536 lishing, 2012, pp. 144–208.
- 537 [11] B. Feneuil, O. Pitois, N. Roussel, Effect of surfactants on the yield stress  
538 of cement paste, *Cement and Concrete Research* 100 (2017) 32–39.
- 539 [12] T. Zhang, S. Shang, F. Yin, A. Aishah, A. Salmiah, T. Ooi, Adsorptive be-  
540 havior of surfactants on surface of Portland cement, *Cement and Concrete  
541 Research* 31 (2001) 1009–1015.
- 542 [13] N. Roussel, G. Ovarlez, S. Garrault, C. Brumaud, The origins of thixotropy  
543 in fresh cement pastes, *Cement and Concrete Research* 42 (2012) 148–157.

- 544 [14] N. Roussel, P. Coussot, Fifty-cent rheometer for yield stress measurements:  
545 From slump to spreading flow, *Journal of Rheology* 49 (3) (2005) 705–718.
- 546 [15] T. G. Mason, J. Bibette, D. A. Weitz, Yielding and flow of monodisperse  
547 emulsions, *Journal of Colloid and Interface Science* 179 (1996) 439–448.
- 548 [16] A. Saint-Jalmes, J. Durian, Vanishing elasticity for wet foams: Equivalence  
549 with emulsions and role of polydispersity, *Journal of Rheology* 43 (1999)  
550 1411.
- 551 [17] M. D. Bolton, The strength and dilatancy of sands, *Géotechnique* 36 (1)  
552 (1986) 65–78.
- 553 [18] A. Fall, G. Ovarlez, D. Hautemayou, C. Mézière, J.-N. Roux, F. Chevoir,  
554 Dry granular flows: Rheological measurements of the  $\mu(i)$ -rheology, *Journal*  
555 *of rheology* 59 (4) (2015) 1065–1080.
- 556 [19] F. Gorlier, Y. Khidas, O. Pitois, Yielding of complex liquid foams, *Journal*  
557 *of Rheology* 61 (2017) 919–930.
- 558 [20] S. Wei, Z. Yunsheng, M. Jones, Using the ultrasonic wave transmission  
559 method to study the setting behavior of foamed concrete, *Construction*  
560 *and Building Materials* 51 (2014) 62–74.
- 561 [21] V. Chaplain, P. Mills, G. Guiffant, P. Cerasi, Model for the flow of a yield  
562 fluid through a porous medium, *Journal de Physique II* 2 (1992) 2145–2158.
- 563 [22] N. Louvet, R. Höhler, O. Pitois, Capture of particles in soft porous media,  
564 *Physical Review E* 82 (2010) 041405.
- 565 [23] L. Gibson, M. Ashby (Eds.), *Cellular Solids: Structure and Properties*,  
566 Cambridge University Press, Cambridge, 1997.



- <sup>567</sup> [24] F. Gorlier, Y. Khidas, O. Pitois, Coupled elasticity in soft solid foams,  
<sup>568</sup> Journal of Colloid and Interface Science 501 (2017) 103–111.