



**HAL**  
open science

## In situ DC electrical resistivity mapping performed in a reinforced concrete wharf using embedded sensors

Johann Priou, Yann Lecieux, Mathilde Chevreuil, Virginie Gaillard, Cyril Lupi, Dominique Leduc, Emmanuel Rozière, Romain Guyard, Franck Schoefs

### ► To cite this version:

Johann Priou, Yann Lecieux, Mathilde Chevreuil, Virginie Gaillard, Cyril Lupi, et al.. In situ DC electrical resistivity mapping performed in a reinforced concrete wharf using embedded sensors. Construction and Building Materials, 2019, 211, pp.244 - 260. 10.1016/j.conbuildmat.2019.03.152 . hal-03484514

**HAL Id: hal-03484514**

**<https://hal.science/hal-03484514>**

Submitted on 20 Dec 2021

**HAL** is a multi-disciplinary open access archive for the deposit and dissemination of scientific research documents, whether they are published or not. The documents may come from teaching and research institutions in France or abroad, or from public or private research centers.

L'archive ouverte pluridisciplinaire **HAL**, est destinée au dépôt et à la diffusion de documents scientifiques de niveau recherche, publiés ou non, émanant des établissements d'enseignement et de recherche français ou étrangers, des laboratoires publics ou privés.



Distributed under a Creative Commons Attribution - NonCommercial 4.0 International License

1 *In situ DC electrical resistivity mapping performed in a reinforced*  
2 *concrete wharf using embedded sensors.*

3 Johann Priou<sup>a</sup> and Yann Lecieux<sup>a\*</sup> and Mathilde Chevreuil<sup>a</sup> and Virginie Gaillard<sup>b</sup> and Cyril  
4 Lupi<sup>a</sup> and Dominique Leduc<sup>a</sup> and Emmanuel Rozière<sup>c</sup> and Romain Guyard<sup>a</sup> and Franck  
5 Schoefs<sup>a</sup>

6 <sup>a</sup>Laboratoire GeM (UMR 6183), Université de Nantes, CNRS, Centrale Nantes, 2, rue de la  
7 Houssinière, 44322 Nantes Cedex 3, France

8 <sup>b</sup>Laboratoire GeM (UMR 6183), ICAM, Département Génie Electrique, 35 Avenue du champ  
9 de Manceuvres, 44470 Carquefou, France

10 <sup>c</sup>Laboratoire GeM (UMR 6183), Centrale Nantes, CNRS, Université de Nantes, 1 Rue de la  
11 Noë, 44321 Nantes Cedex 3, France\*

---

12 **Abstract**

13 Installation, calibration protocol and data analysis of multi-electrode sensors embedded in  
14 concrete are proposed in this study. Measurements of resistivity are performed in a port wharf and  
15 analyzed in parallel with measurements of humidity, temperature, and evolution of the mechani-  
16 cal strength of concrete. The correlation between the evolution of the compressive strength and  
17 the resistivity, allows to validate the measurement protocol proposed. To visualize the distribu-  
18 tion of resistivities in the studied volume, pseudo-sections of apparent resistivity were displayed.  
19 A methodology to plot and use them as an indicator of corrosion adapted to civil engineering  
20 structures is proposed.

21 *Keywords:* Electrical DC resistivity, SHM, Embedded sensors, Coastal structures, Concrete

---

22 **1. Introduction**

23 The electrical resistivity quantifies the ability of a material to oppose the flow of electric  
24 current. This physical characteristic is related to the nature of the medium, its porosity and its  
25 electrolyte content. Direct Current (DC) electrical resistivity measurements have thus naturally  
26 been used for many years in geophysics to obtain subsoil images by tomography [1, 2] and esti-  
27 mate its constitution (type of rock, presence of water, trace of pollutant, etc.). In rocks the electric

---

\*Corresponding author. Email: [yann.lecieux@univ-nantes.fr](mailto:yann.lecieux@univ-nantes.fr)  
*Preprint submitted to Elsevier*

March 1, 2019

28 current propagates essentially through the open porosity by the intermediate of the interstitial flu-  
29 ids, generally water [3]. The electrolytic resistivity of rock is given by Archie's empirical law  
30 [4, 5]. The conduction via the pore solution of concrete can also be described by the Archie's law  
31 [6, 7]. Resistivity measurements are therefore also used in civil engineering for various appli-  
32 cations. These include crack detection [8], porosity or mechanical strength monitoring [9], and  
33 concrete moisture content assessment [10, 11, 12]. Corrosion monitoring, the issue of interest in  
34 this study, is also an important field of application for resistivity measurement [13, 14, 15, 16].  
35 The resistivity value is used as an indicator of the probability of corrosion. In the case of pit-  
36 ting corrosion induced by chlorides, it is possible, by calibrating the resistivity measurement, to  
37 assess the level of free chloride in a given concrete [10, 17, 18, 19, 20].

38 One hundred works and applications covering the field of resistivity measurement in concrete  
39 were identified in the reviews [21, 22]. Most of the experiments listed in [21] were carried out in  
40 the laboratory on test specimens without reinforcement bars.

41 Many measurement devices exist such as: discs, devices with 4 electrodes arranged in squares  
42 or aligned and most often interrogated with a Wenner protocol. There are also multi-electrode  
43 devices that allow, as in Geophysics, to display a resistivity section of the medium [23, 18, 24].  
44 For on-site applications the most commonly used devices are portable Wenner probes for punc-  
45 tual measurement. Although simple to use and relatively inexpensive, they have two significant  
46 drawbacks. On the one hand, this system is suitable for punctual measurements as part of inspec-  
47 tion campaigns. It is not designed to be integrated into a SHM (Structural Health Monitoring)  
48 measurement chain. On the other hand, the repeatability and reproducibility performances of  
49 these probes are lower than those observed with embedded devices. Coefficients of variations  
50 between 10% and 25% have been reported for variability measurements performed in specimens  
51 of the same batches and exposed identically [13, 25, 26, 18]. This dispersion has several origins,  
52 including the variability of the material and the variability of the contact resistance between the  
53 concrete surface and the measuring electrodes [27]. This observation shows the importance of  
54 the quality to bring to the electrical contact to ensure the reproducibility of the measurement. For  
55 this purpose it is more interesting to opt for an embedded sensor in order to improve the perfor-  
56 mances of the measuring system. It also offer the possibility to perform several measurements  
57 in the same location to avoid any bias due to material spatial variability of physical properties of  
58 concrete. This local variability is shown to have significant influence on resistivity measurement

59 due to the change of the path of current lines [27]. Spatial variability of chloride content [28] is  
60 also an issue.

61 To take full advantage of all the possibilities offered by electrical DC resistivity measurement  
62 [21, 22], current works must now focus on *in situ* installation of devices integrated into SHM  
63 measurement chain. These sensors should have the following characteristics:

- 64 • be embedded in concrete during the construction of the structure, to improve the repeata-  
65 bility of measurements, to get data in areas that are difficult to access and to follow the  
66 evolution from concreting to operation time;
- 67 • take into account the presence of reinforcement bars, either through a correction of the  
68 measurement [13, 29], or through a specific installation protocol [30];
- 69 • take temperature variations into account [31, 32, 24];
- 70 • give a large number of measurement points to decrease the amount of false alarm or bad  
71 detections [24, 33, 23, 18];
- 72 • obtain a mapping of resistivity in the concrete cover area [33, 23, 18] and better asses  
73 spatial variability.

74 The objective of this study is to propose a complete methodology for the installation and  
75 use of an on-site resistivity measurement device for the continuous monitoring of a reinforced  
76 concrete structure located in the splash zone of a marine environment, from its construction to  
77 its dismantling. The methodology **addresses** the following points:

- 78 • the *in situ* installation;
- 79 • the calibration protocol;
- 80 • the data analysis.

81 The section 2 is dedicated to the presentation of the sensors and their installation in a port  
82 wharf located at the mouth of the Loire river (on the west coast of France). **Resistivity sen-**  
83 **sors (based on the technology used in the study [18])** were installed on two beams during the  
84 construction of the wharf together with temperature and humidity sensors. **The sensors were**  
85 **installed within the framework of the project iMARECO2 (french acronym for Monitoring for**

86 Maintenance, Reassessment and Optimal Design) managed by Keops Automation, with partners  
87 Université de Nantes, Nantes – Saint Nazaire Port and Bouygues Construction. It relies on the  
88 monitoring of a wharf during its construction, commissioned by Nantes – Saint Nazaire Port  
89 (Nantes – Saint Nazaire harbor, France). This section also describes concrete characterizations  
90 performed in laboratory. The principle of resistivity measurements with our sensors and their  
91 experimental validation are presented in section 3. The section 4 is the core of the analysis. It  
92 presents original developments on the adaptation of conventional methods used on geophysics  
93 to civil engineering structures, which allow the display and exploitation of apparent resistivity  
94 measurements. The last section, “results and discussion”, is dedicated to the presentation of all  
95 the measurements (resistivity, humidity, temperature, compressive strength) and the correlations  
96 between the different measurements. The evolution of concrete at early age and then during the  
97 first year of the structure is monitored. The observation of phenomena related to concrete setting  
98 made it possible to validate measurement protocols and analysis methods, as well as to assess  
99 the *in situ* performances of the resistivity sensor and the measurement method proposed.

## 100 **2. Material and Methods**

### 101 *2.1. Studied structure and measurement system*

#### 102 *2.1.1. The wharf*

103 The instrumented structure is a 350 meter long, 50 meter wide on pile wharf with a platform  
104 (slab and beams) in concrete. The structure is made of partly precast reinforced concrete elements  
105 (see Figure 1a). Precast elements are supported by 579 steel piles distributed over 10 longitudinal  
106 rows and 56 transverse rows (see Figure 1b). The precast elements are first laid down on the heads  
107 of steel piles. The junctions between these elements are reinforced with steel bars and then filled  
108 with concrete for ensuring the embedded connection. The concrete elements act as formwork for  
109 the structural parts of the wharf called “beams”. Two beams at the end of the wharf are equipped  
110 with sensors. They are marked in Figure 1b.

#### 111 *2.1.2. Structural Health Monitoring (SHM) system for resistivity measurement*

112 The wharf has been equipped with a multi-sensor system for the monitoring of concrete  
113 ageing. The measurement chain is designed to detect the long term penetration of chloride ions  
114 before it reaches the reinforcement and pitting corrosion begins. We are therefore particularly  
115 interested in the monitoring of concrete cover (see Figure 2a). The studied concrete elements are

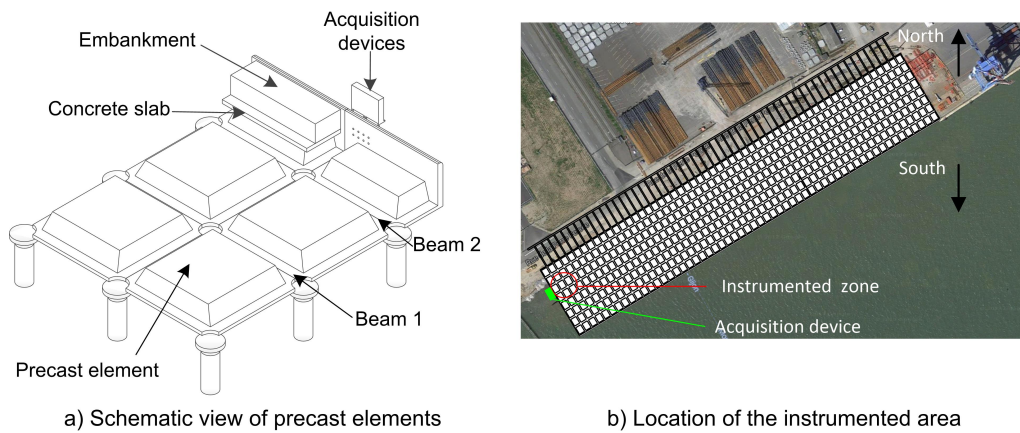

Figure 1: The wharf: building system and sensors location.

116 in the splash zone. Humidity, temperature and resistivity sensors were embedded in the concrete  
 117 during the construction of the structure. They are located in each beams as shown in Figure 2.

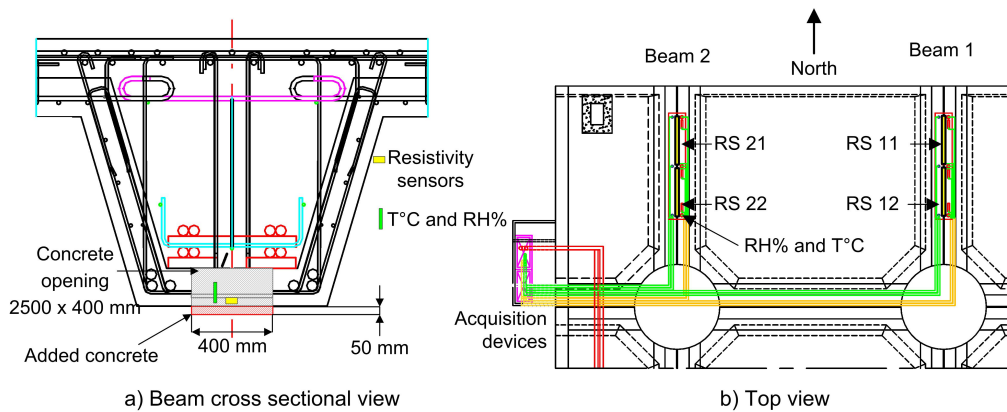

Figure 2: Location of resistivity sensors (referenced RS).

118 The lower part of each instrumented beam is equipped with:

- 119 • 2 resistivity sensors designed on the technology described in section 2.2;
- 120 • 3 combined humidity and temperature probes (ROTRONIC);
- 121 • 2 temperature probes Pt100.

122 Pt100 temperature sensors and humidity probes are positioned near resistivity sensors. Tem-  
 123 perature sensors are used for the compensation of thermal effects on resistivity measurements.

124 They have also been used to determine the mechanical strength of *in situ* concrete using the  
 125 maturity method. Position of these sensors are presented in Figure 3.

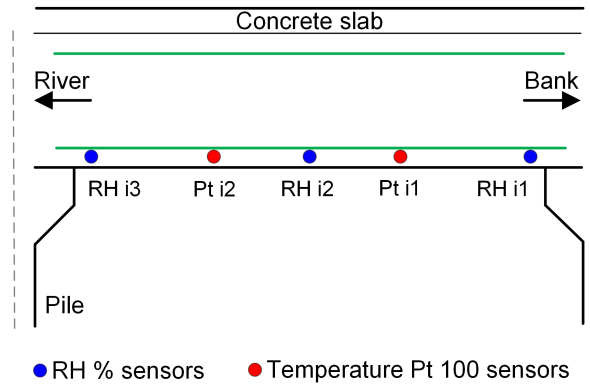

Figure 3: Schematic view of the longitudinal cross section of the beam: location of temperature and humidity sensors. The label  $i = 1$  or  $2$  is the beam number.

126 Data acquisition for temperature and humidity sensors is carried out with a NI cDAQ-9133  
 127 acquisition unit. The whole installation (batteries, electronics, central unit, wires for resistivity  
 128 measurement) allowing data acquisition has been integrated into waterproof boxes to protect it  
 129 from external aggressions (wind, rain, tide, etc.). The boxes are positioned at the downstream  
 130 end of the platform as shown in Figure 1.

### 131 2.2. The resistivity sensor and its acquisition device

132 The sensor embedded in the concrete structure consists of 32 electrodes in stainless steel  
 133 spaced of  $a = 35$  mm screwed into a 1.135 m long PVC bar. The exact dimensions of the sensors  
 134 are visible in the Figure 4.

135 The resistivity measurements are performed punctually with a resistivimeter ABEM terram-  
 136 eter LS used by geophysicists which can also be used for civil engineering applications [18, 23].  
 137 The device injects current and measures potential differences on a line containing 4 to 32 elec-  
 138 trodes in a user-defined sequence. Parameters such as the intensity of the current injected and  
 139 the injection time are adjustable. The optimization of these parameters has been the subject of  
 140 preliminary studies [18].

### 141 2.3. Proposed *in situ* installation of the resistivity sensor

142 The sensor installation has to meet the following operational constraints:

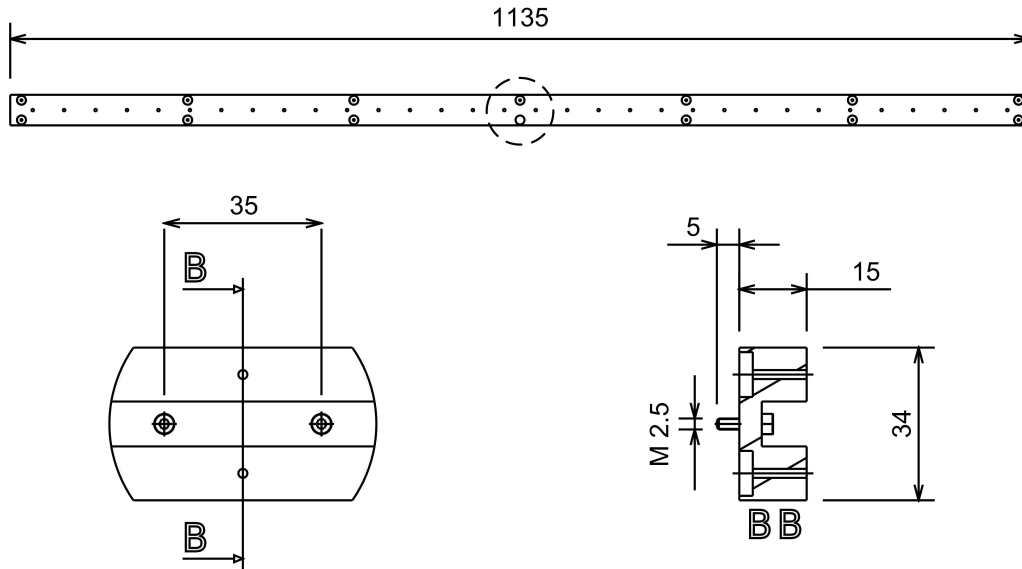

Figure 4: Sketch of the 32 electrode sensor. Dimensions are given in millimeters.

- 143 • First, the sensors must be placed in the center of the beams. This location required an
- 144 opening on two prefabricated elements positioned side by side (see Figure 5a and 5b). The
- 145 state of the structure before installation of the sensors is thus described in these figures 5a
- 146 and 5b. The opening must then be filled with concrete poured into a formwork added to
- 147 the structure after installation of the sensors (area drawn in red in Figure 5c);
- 148 • No electrical wires should run from the concrete bottom surface to the reinforcement to
- 149 avoid creating a preferential path for seawater;
- 150 • The installation must be fast so as not to slow down the construction process;
- 151 • The sensor must probe the most relevant area. The concentration of chlorides is the highest
- 152 in the zone located between 0 and 5 centimeters under the external concrete surface [10].
- 153 Cover concrete is then the zone where monitoring is the most interesting for early detection
- 154 of chloride ion penetration in concrete and therefore detection of corrosion risk;
- 155 • The sensor must be insensitive to reinforcement bars. Indeed, the data analysis is based
- 156 on a finite element (FE) simulation. If the sensor were sensitive to reinforcement bars, it
- 157 would be necessary to accurately modelized these bars in order to take into account their



158 influences on the resistivity measurement. However, on site, the actual positioning of the  
 159 reinforcement bars is never exactly the same as planned. It would therefore be necessary  
 160 to perform an accurate position report of the actual reinforcement bars. Moreover, as the  
 161 reinforcement bars used are different according to the location within the beam, it would  
 162 be necessary to carry out a different FE model of the volume studied for each sensor.  
 163 Last, FE models representing reinforcements are complex and cannot be simplified. The  
 164 simulations would therefore be expensive in terms of calculation time.

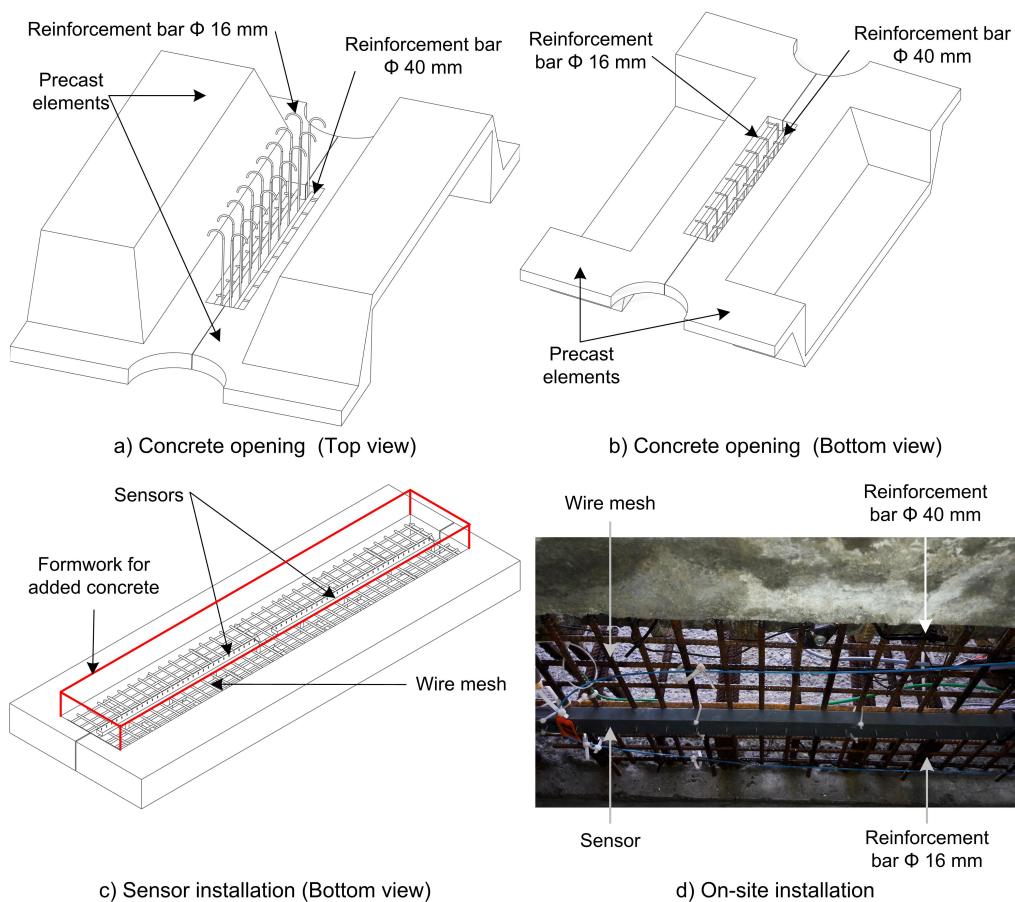

Figure 5: View of precasted concrete elements before (a and b) and after (c and d) the sensors are installed.

165 The technical solution chosen for the installation of the sensors, in agreement with all the  
 166 criteria listed above, consists in installing the two sensors on a welded wire mesh of the size of  
 167 the opening in the concrete (see Figure 5c). It was fixed on the 16 mm diameter reinforcements

168 visible on Figure 5d. The wire mesh is connected to the ground of the measuring instrument via  
169 an electrical wire.

170 A welded wire mesh with a sufficiently fine mesh can be considered as a conductive plate.  
171 Adding a conductive element between the reinforcement and the sensors confines the electrical  
172 currents within the volume delimited by the concrete surface on the bottom side and the welded  
173 mesh on the top side. The interest of the system is twofold. First, the resistivity measurement is  
174 thus rendered insensitive to the presence of conductive elements (the reinforcement) located on  
175 the other side of the conductive plate. Secondly, the volume surveyed using resistivity measure-  
176 ments is simple to modelize, since it is a rectangular volume without reinforcements except the  
177 welded mesh (see volume in red in Figure 5c).

178 On site, however, it is not possible to install a metal plate or very dense mesh. The meshes  
179 must be wide enough to allow the aggregates and the needle to vibrate the concrete to pass  
180 through. A 35 mm mesh could be installed on site. A numerical sensitivity analysis performed  
181 with a model of the welded mesh and presented in the section 4 demonstrates that the mesh  
182 size used here is acceptable to avoid that the reinforcement bars influence the measurements of  
183 resistivity in cover concrete.

#### 184 2.4. *Materials and mixture used on-site*

185 The composition of cast-in-place concrete is given in Table 1. The strength class was C40/50  
186 and the mixture complied with the requirements of French Standard NF EN 206-1 for XA2  
187 exposure class; i.e. minimum binder content of 350 kg/m<sup>3</sup> and maximum Effective water to  
188 Binder (Weff/Beq) ratio of 0.50. Portland cement CEM I 52.5 N SR3 was used to provide sulfate  
resistance. The actual Weff/Beq ratio was 0.45.

	Content (kg/m <sup>3</sup> )
Gravel 11/22	740
Gravel 2/10	300
Sand 0/4	810
Cement CEM I 52.5 N SR3 (C)	360
Plasticizer	3.8
Water effective	161

Table 1: Composition of concrete mix

189

190 2.5. Characterization of concrete performed in laboratory environment

191 In addition to the measurements carried out on site, laboratory tests were performed in order  
192 to get key properties of the concrete. The day when the beams were casted, 40 cylindrical samples  
193 of 110 mm diameter and 220 mm height were made with the same concrete and at the same time.  
194 After one day, they were stored in water at 3 different temperatures, 10 °C, 20 °C and 40 °C. The  
195 aim of the characterization tests was to obtain:

- 196 • the porosity accessible to water;
- 197 • the compressive strength;
- 198 • the equivalent age.

199 Permeability is an indicator of concrete durability since it controls the rate at which aggres-  
200 sive agents such as ions in sea water can penetrate into concrete. Number of scientific studies  
201 underline the strong correlation between the porosity of a concrete and its permeability [34, 35].  
202 When porosity is reduced, permeability also decreases. Porosity is thus an essential character-  
203 istic of reinforced concrete [36]. In this study, water porosity was assessed after 90-day wet  
204 curing on three concrete discs by the vacuum water saturation method, according to French stan-  
205 dard NF P18-459. An interesting feature of the resistivity comes from its link to porosity since  
206 porosity evolves with hydration [37]. Porosity decreases during the first 90 days leading to an  
207 increase in resistivity. At the same time, the mechanical strength of concrete is influenced by  
208 porosity. Resistivity measurement can thus be considered as an interesting indicator of durability  
209 [38] and material hardening. Thus, in section 5, resistivity measurements are compared with  
210 porosity measurements. Then, the evolution of the *in situ* mechanical strength is computed at an  
211 equivalent age.

212 Compressive strength characterization was also carried out in laboratory. The compressive  
213 strength was measured at 1, 2, 7 and 28 days on the specimens stored in water at 10°C, 20°C and  
214 40 °C. 30 specimens were tested, i.e. 3 specimens on day 1 and 3 specimens for each temperature  
215 range on days 2, 7 and 28. The objective of these tests was to assess the compressive strength  
216 of the concrete of the *in situ* structure. For this purpose, the maturometry technique was used. It  
217 aims at the computation of the age of an on-site concrete equivalent to a concrete stored in the  
218 laboratory at a reference temperature  $T_{\text{ref}} = 20$  °C. This calculation requires knowledge of the  
219 thermal history of the structure (measured with PT100 probes) [39, 40]. Maturometry is firstly

220 based on the fact that the compressive strength of concrete depends only on its temperature. For  
 221 a constant temperature, the mechanical strength of concrete can be described by the following  
 222 expression [41]:

$$f_c(\tau; T, T_{\text{ref}}) = f_{c28d}(T_{\text{ref}}) e^{s(T_{\text{ref}}) \left(1 - \sqrt{\frac{28}{\tau(T, T_{\text{ref}})}}\right)} \quad (1)$$

223 where  $\tau$  is the age of the concrete in days for the reference temperature  $T_{\text{ref}}$  or the equivalent  
 224 age for a temperature  $T \neq T_{\text{ref}}$ ,  $s$  the adjustable parameter and  $f_{c28d}$  the compressive strength  
 225 assessed at 28 days and at the reference temperature, here chosen  $T_{\text{ref}} = 20^\circ\text{C}$ .

226 Secondly, the sensitivity of concrete hardening to temperature is given by Arrhenius law,  
 227 whose unique parameter  $E_a$  called apparent activation energy [J/mol] characterizes the curing of  
 228 a concrete. The activation energy is related to the equivalent age of the concrete and its thermal  
 229 history by the following relationship (2) [42]:

$$\tau(t; T, T_{\text{ref}}) = \int_0^t e^{-\frac{E_a}{R} \left[ \frac{1}{T(\theta)} - \frac{1}{T_{\text{ref}}} \right]} d\theta \quad (2)$$

230 where  $t$  is the considered time period (days),  $R$  is the gas constant 8.314 J/mol.K and  $T$  (K) is the  
 231 average absolute temperature of concrete.

232 It is thus possible to calculate the apparent activation energy of a concrete from the mechan-  
 233 ical strength of the material stored at different temperatures following these steps:

- 234 • First, parameter  $s$  in equation (1) is determined from the mechanical strength curve of the  
 235 samples stored at  $T_{\text{ref}} = 20^\circ\text{C}$ ;
- 236 • In a second step, the parameter  $E_a$  is calculated in such a way as to minimize the difference  
 237 between the compressive strength measurement at  $10^\circ\text{C}$  and  $40^\circ\text{C}$  considering equivalent  
 238 age computed with equation (2) and the model of the equation (1);
- 239 • Once  $E_a$  has been determined, the equivalent age of the actual structure can be determined  
 240 at any point on the structure equipped with a temperature probe;
- 241 • Then, it is possible to calculate the mechanical strength of the real concrete at a given time  
 242 with equation (2) using experimental data collected in laboratory and on-site temperature  
 243 measurement.

244 **3. Resistivity measurement: protocol and performance assessment within the framework**  
 245 **of the *in situ* installation**

246 *3.1. Principle and protocol*

247 The resistivity measurement technique used in this study is the direct current electrical to-  
 248 mography method. It is commonly used in the field of geophysics [1]. This measurement tech-  
 249 nique consists in successively using several sets of four surface electrodes to obtain one resistiv-  
 250 ity measurement. Two electrodes are used to inject an electric current into the studied volume.  
 251 These two electrodes are respectively labelled A (injected current I) and B (injected current -  
 252 I) (see Figure 6). The other two electrodes labelled M and N are used to measure a potential  
 253 difference  $\Delta V$ .

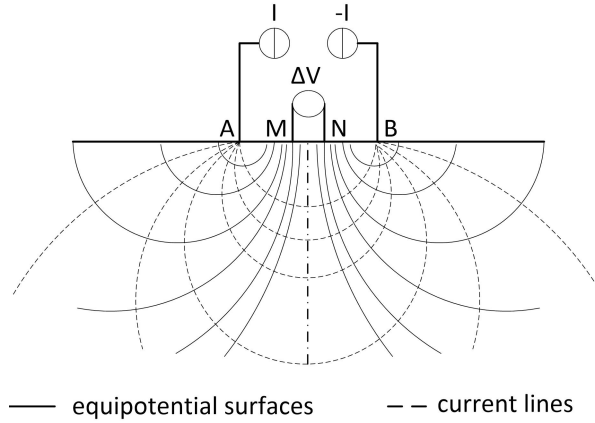

Figure 6: Principle of the resistivity measurement with a four electrode device. The equipotential surfaces drawn on the Figure correspond to a semi-infinite homogeneous medium.

254 For a homogeneous medium of resistivity  $\rho$  ( $\Omega\text{m}$ ), the relationship between the imposed  
 255 current I, the potential difference  $\Delta V$  and the resistivity is given by equation (3):

$$\rho_{app} = G \frac{\Delta V}{I} \quad (3)$$

256 where  $G$  (1/m) is the geometric factor. This geometric factor is only function of the interrogation  
 257 protocol (Wenner alpha, beta, gamma, Schlumberger, Dipole-Dipole) and of the geometry of  
 258 the studied volume. In geophysics, the medium is assumed to be semi infinite. In this case,  $G$   
 259 depends only on the distance between the electrodes of the considered quadripole. For a Wenner  
 260 alpha protocol,  $AM = MN = NB = a$ , thus  $G = 2\pi a$ . The factor  $2\pi a$  is also the one used for the  
 261 analysis of potential measurement performed with a portable resistivity probe. However, if the

262 medium is not semi-infinite, (for instance in in civil engineering in beams or slabs),  $G$  depends  
 263 also on the specimen geometry. In such a case, the  $G$  factor has to be evaluated numerically or  
 264 experimentally.

265 Finally, when the medium is not homogeneous, the resistivity, calculated from equation (3)  
 266 is called apparent resistivity. The 32 electrodes of the sensor allow  $m = 129$  measurements with  
 the Wenner alpha protocol. The corresponding sequence is given on Figure 7.

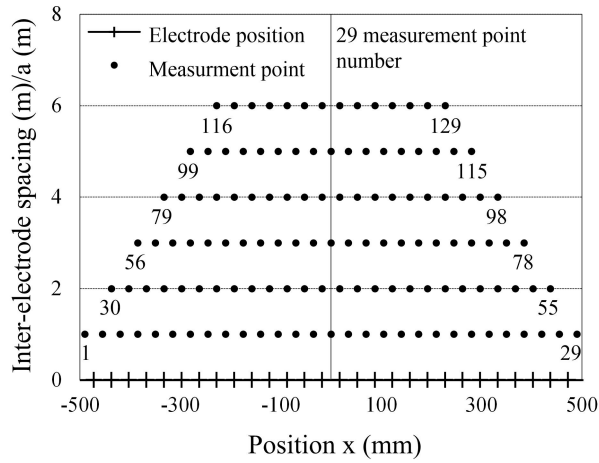

Figure 7: Graphical representation of the Wenner alpha protocol measurement points with respect to the positions of the 32 electrodes.

267

268 From the  $m$  experimental or numerical measurements we deduce the geometric factors  $G^j =$   
 269  $\rho \frac{I}{\Delta V^j}$ , for  $j = 1, \dots, m$ . These are used to define the measured apparent resistivities  $\rho_{app}^j = G^j \frac{\Delta V^j}{I}$   
 270 linked to the  $j^{\text{th}}$  measurement.

271 Resistivity measurements were performed during 18 months, several times a week during the  
 272 first weeks in order to observe the evolution of concrete at early age. Further measurements are  
 273 planned during next years but on a half-yearly basis. From all these measurements a resistiv-  
 274 ity mapping is obtained. It represents the apparent resistivity of the volume located under the  
 275 measuring electrodes and it is called pseudo-section of apparent resistivity.

### 276 3.2. Assesment of measurement repeatability and trueness in laboratory and in situ

277 The quantification of measurement uncertainties is necessary, especially in civil engineering  
 278 since concrete is a heterogeneous medium. Thus, the repeatability of the resistivity measure-  
 279 ments was evaluated on site within concrete and in a homogeneous environment of constant

280 resistivity but including the same welded mesh as for the on-site installation. A model of the  
 281 volume of concrete studied on site was reproduced for laboratory tests (volume in red in Figure  
 282 5c). A wooden mould was equipped with a welded mesh and a resistivity sensor identical to  
 283 those embedded on site in the concrete beams. The volume was filled with water maintained at a  
 284 constant temperature of 20° C. The resistivity of water was obtained using a conductivity probe  
 285 considered as the reference. Five repeatability tests have been performed for each of the  $m = 129$   
 286 measurement points  $\{M^j\}_{j=1}^m$  (Figure 7). The repeatability error is computed as the coefficient of  
 287 variation of the sample  $\tilde{\rho}^j = \{\rho_{app,k}(M^j)\}_{k=1}^5$  containing the 5 values of the repeatability test:

$$\text{CoV}(\tilde{\rho}^j) = \frac{\sqrt{\text{Var}(\tilde{\rho}^j)}}{\bar{\rho}^j}, \quad j \in \{1, \dots, m\} \quad (4)$$

288 where  $\bar{\rho}^j$  and  $\text{Var}(\tilde{\rho}^j)$  are the mean value and the variance of the sample  $\tilde{\rho}^j$ . Repeatability tests  
 289 were performed in water of variable resistivity. The resistivity values [23, 92 Ωm] are chosen to  
 290 match with the values expected to be measured on site. The value of about 20 Ωm is expected  
 291 for a concrete at early age while 100 Ωm could be the resistivity value of a concrete with a high  
 292 water saturation after few weeks. The results are plotted on Figure 8 with respect to the sequence  
 293 of measurement points presented in Figure 7.

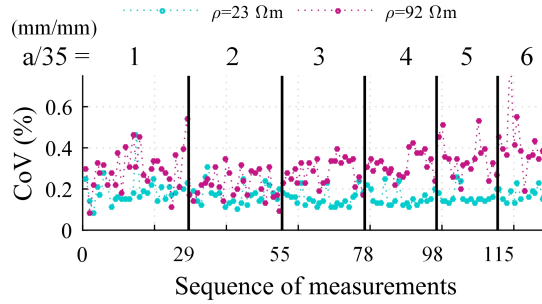

Figure 8: Coefficients of variation  $\text{CoV}(\tilde{\rho}^j)$  of the  $m = 129$  measurements for tests performed in water using 10 mA current injection.

294 The coefficients of variation are very low in both cases since they are less than 0.55 % (except  
 295 the value of 0.87 for one measurement) and close to those found in [25]. It should be noted that  
 296 after one year, the average value of the resistivity measured on site was less than 100 Ωm and  
 297 consequently, the input parameters of the device (injected current, time of injection, protocol, etc.)  
 298 are adapted. Similarly, repeatability tests conducted on the wharf made it possible to evaluate the  
 299 performance of the *in situ* device as shown in Figure 9.

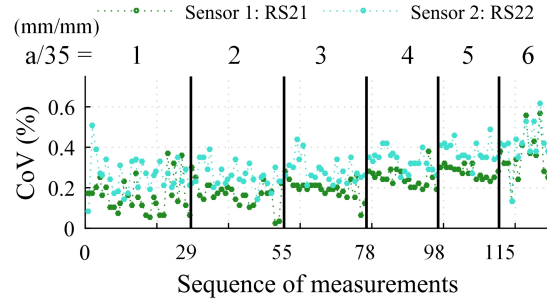

Figure 9: Coefficient of variation  $\text{CoV}(\bar{\rho}^j)$  of the  $m = 129$  measurements for tests performed *in situ* using 10 mA current injection.

300 The value of the coefficient of variation recorded on site is slightly higher than that observed  
 301 in the laboratory, but remains very low (less than 0.6 %). The difference is explained by the  
 302 presence of more sources of uncertainties *in situ*, including variations in contact resistance or  
 303 poor compensation for thermal effects. It is also possible to assess the accuracy error but only  
 304 for measurement performed in water and using the geometric factor computed numerically. For  
 305 a set of 5 repeatability tests, a reference value is given by the conductivity probe  $\hat{\rho}$ . The bias is  
 306 computed using the equation (5):

$$b^j = |\hat{\rho} - \bar{\rho}^j|. \quad (5)$$

307 The bias also represents the trueness error in this case. It represents in particular the error on  
 308 the modelling performed using the direct finite element model since the bias is related to an  
 309 approximate numerical evaluation of the geometric coefficient  $G$ . The results obtained confirm  
 310 the global relevance of our finite element model (see section 4) since the relative bias is low (in  
 311 average 0.7  $\Omega\text{m}$  for the medium of 23  $\Omega\text{m}$  and 2.4  $\Omega\text{m}$  for the medium of 92  $\Omega\text{m}$ ) except for 12  
 312 measurement points (see Figure 10). The latter are those made with the electrodes at the ends of  
 313 the sensor. This means that FE modelling does not correctly predict the propagation of current  
 314 near the lateral edges of the sensor with this geometric configuration. Consequently, in the rest  
 315 of the study, in order to avoid misinterpretations this measures were removed from the database.  
 316 Finally 117 measurement will be kept (129 minus 12 measurements, *i.e.* two measurements at  
 317 each end of the sensor for a given spacing, considering 6 different spacings).



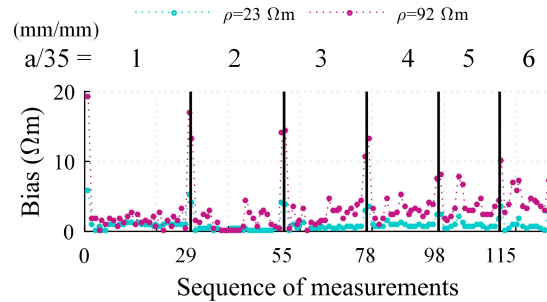

Figure 10: Relative bias  $b^j$  of the  $m = 129$  measured apparent resistivities for tests performed in water using 10 mA current injection.

#### 318 4. Mapping of resistivity measurements

319 The set of  $m=117$  resistivity measurements obtained for a given time period allow three levels  
 320 of analysis to be performed:

- 321 • The average apparent resistivity representative of the material is estimated from a large  
 322 number of measurements performed in a small volume. The dispersion of the measure-  
 323 ments reflects the heterogeneity of the concrete. The average value is useful information  
 324 for the monitoring of hardening concrete (see section 5). By testing a material containing  
 325 a given chloride content [20, 18] it is also possible to estimate a probability of detection  
 326 of an average free chloride content in the survey area by knowing both average apparent  
 327 resistivity value and dispersion of the measurements;
- 328 • The measurements can be displayed directly through a pseudo section of apparent resis-  
 329 tivity. It does not require numerical inversion and thus allows an instant display of the  
 330 measurement results. It is then possible to visualize areas for which the resistivity varies  
 331 between two measurement campaigns as well as gradient effects due to chloride and hu-  
 332 midity. Apparent resistivity is also useful for calculating the true resistivity obtained by  
 333 reverse analysis. Indeed, in all algorithms currently in use, the initial value of true resis-  
 334 tivity is the apparent resistivity.
- 335 • The true resistivity obtained by inversion allows the exact location of areas of variable re-  
 336 sistivity. However, there is currently no algorithm available to quickly and reliably reverse  
 337 apparent resistivity measurements for *in situ* use applied to civil engineering structures  
 338 [43]. This point has not been addressed in the context of this paper, whose subject is

339 the development of tools usable *in situ* or in a supervision program (i.e. without reverse  
340 analysis).

341 The objective of this section is to propose a method for obtaining pseudo-sections of apparent  
342 resistivity in the context of a measurement carried out on a reinforced concrete structure. The  
343 methodology used is strongly inspired by the techniques used in the field of geophysics. The  
344 methods applied in this context are briefly described and the necessary adaptations to the field of  
345 civil engineering highlighted.

#### 346 *4.1. Apparent resistivity in geophysics: practice and limits*

347 In geophysics, the measurements of the electric potential differences are displayed through  
348 the apparent resistivity defined with equation (3) where the geometric factor  $G$  is determined so  
349 that the apparent resistivity is equal to the true resistivity when the medium is homogeneous.  
350 In the case of the semi-infinite medium as it is encountered in geophysics, the geometric factor  
351 can be defined analytically (see section 3.1). When the studied space is not homogeneous, the  
352 apparent resistivity gives only an approximate representation of the true resistivity [3, 2].

353 The apparent resistivity is displayed in the 2D space at data points with cartesian coordinates  
354  $(x, z)$ . The  $x$ -coordinate is obtained with the  $x$  positions of the electrodes, for instance for a  
355 Wenner device,  $x$  is the middle of the 4 electrodes. The  $z$ -coordinate is defined with a sensitivity  
356 analysis based on the Frechet derivatives. The sensitivity is studied as a function of the depth.  
357 By convention, the  $z$ -coordinate value corresponds to the depth (or distance to the sensor) where  
358 half of the Frechet derivative integral is obtained.

359 In the present study, the medium is not semi-infinite and consequently, first we have to assess  
360 the geometric factor, and second we cannot compute the Frechet derivatives. We thus propose  
361 to assess the geometric factor by considering the geometry of the monitored domain and the  
362 presence of the wire mesh and the sensor (see section 4.3.1) and we propose an approach, that  
363 mimics the analytical approach where the apparent resistivity coefficients result from a sensitivity  
364 analysis using an approximation of the solution of the resistivity problem (section 4.2).

#### 365 *4.2. Proposed methodology for displaying the apparent resistivity for any geometry*

##### 366 *4.2.1. Parametrization*

367 In this section, we propose a methodology to display the apparent resistivity for any elec-  
368 trostatic problem. It is based on a sensitivity analysis of the electric potential differences with

369 respect to the resistivity where the resistivity is simply modeled with constant coefficients by  
370 blocks. Let  $\rho_i$  with  $i \in I = (1, \dots, d)$  be the resistivity coefficients allocated to the  $d$  disjointed  
371 blocks of the medium and let  $\Delta V^j$ ,  $j = 1, \dots, m$ , the electric potential differences that solve the  
372 electrostatic problem using this parametrization. By considering a finite range of possible values  
373 for each resistivity coefficient, we introduce sensitivity indices that quantify the part of the vari-  
374 ance of  $\Delta V^j$  due to the variability of  $\rho_i$  and that are derived from the Sobol indices  $\frac{\text{Var}(\mathbb{E}(\Delta V^j|\rho_i))}{\text{Var}(\Delta V^j)}$ .  
375 In this expression, the conditional expectation  $\mathbb{E}(\Delta V^j|\rho_i)$  represents the function of  $\rho_i$  only which  
376 best approximates  $\Delta V^j$ , its variance  $\text{Var}(\mathbb{E}(\Delta V^j|\rho_i))$  thus measures the fluctuation of  $\Delta V^j$  as if it  
377 were a function of  $\rho_i$  only, and it is normalized by the total fluctuation of  $\Delta V$  [44]. Here we rather  
378 use indices normalized with the maximal variance of the potential differences to better consider  
379 the most influenced measures:

$$S_i^j = \frac{\text{Var}(\mathbb{E}(\Delta V^j|\rho_i))}{\max_{l=1, \dots, m}(\text{Var}(\Delta V^l))}. \quad (6)$$

380 The sensitivity indices can be computed using Monte Carlo simulation methods [45] or using  
381 approximations of  $\Delta V^j$  on functional bases [46].

382 The blocks are sized so to have an equivalent influence over the measurements, *i.e.* such that  
383  $S_i = \sum_{j=1}^m S_i^j$  are of the same order for all of the blocks  $i \in I$ .

#### 384 4.2.2. Calculation and display of the resistivity

We finally define the apparent resistivity  $\rho_{app,i}$  displayed in block  $i$  as a weighted sum of the  
measured apparent resistivities with respect to the sensitivity indices:

$$\rho_{app,i} = \frac{\sum_{j=1}^m S_i^j \rho_{app}^j}{\sum_{j=1}^m S_i^j} \quad (7)$$

385 with  $\rho_{app}^j$  the measured apparent resistivity related to the measured electricity potentials  $\Delta V^j$   
386 with the relation (3) in which the geometric factor  $G$  is determined *a priori* for the studied case.

### 387 4.3. Towards the application on the concrete structure: preprocessed parameters for the display 388 of the apparent resistivity

#### 389 4.3.1. Determination of the geometric factor

390 As mentioned above, the geometric factor  $G$  first needs to be determined according to equa-  
391 tion (3). For the case of the concrete structure studied in the present paper, the geometric factor  
392 has been estimated using the geometry and boundary conditions of the surveyed part of the con-  
393 crete structure, that includes the added concrete marked out in red on Figures 2 and 5 and the

394 layer of concrete containing the wire mesh and the sensor. A finite element model reproducing  
 395 these conditions was used to assess the geometric factor.

Let denote  $\Omega$  the domain occupied by the medium. Its boundary is composed of the outer boundary of the parallelepipedic domain and of the boundaries in contact with the wire mesh and the sensor the geometries of which are modeled faithfully. The electric potential is the solution of problem (8):

$$\begin{aligned}
 & \nabla \cdot \left( -\frac{1}{\rho} \vec{\nabla} V \right) + \delta_A I - \delta_B I = 0 \quad \text{in the medium,} \\
 & -\frac{1}{\rho} \vec{\nabla} V \cdot \vec{n} = 0 \quad \text{on the outer boundary of the domain,} \\
 & -\frac{1}{\rho} \vec{\nabla} V \cdot \vec{n} = 0 \quad \text{on the boundary of the sensor,} \\
 & V = 0 \quad \text{on the boundary of the wire mesh,}
 \end{aligned} \tag{8}$$

397 where  $\rho$  is the resistivity and  $\delta_A I$  and  $\delta_B I$  are punctual sources of electric current  $I$  and  $-I$  imposed  
 398 by the electrodes at points A and B.

399 For the determination of the geometric factors, we consider a homogeneous medium of  
 400 known resistivity  $\rho$  and impose a current intensity  $I = 1$  A. We then compute the electric po-  
 401 tential differences  $\{\Delta V^j\}_{j=1}^m$  for the  $m = 117$  positions of the electrodes with the Wenner device  
 402 from which we deduce the geometric factors  $\{G^j\}_{j=1}^m$ .

#### 403 4.3.2. Parametrization of the numerical model

404 We consider the *in situ* concrete structure. Problem (8) is solved using the finite element  
 405 method. The resistivity is now considered non homogeneous and modeled with a piecewise  
 406 constant resistivity as presented in section 4.2.1 where the blocks are chosen so that the measure-  
 407 ments are equally sensitive to each block. Figure 11 shows an example of the distribution of the  
 408 blocks for modeling the resistivity. The further the layers are from the sensor, the less influent  
 409 they are on the potential differential and thus the larger are the blocks. For the purpose of the  
 410 study which concerns the detection of a chloride front, we assume a uniform resistivity with re-  
 411 spect to the  $y$ -axis. A single block along the  $y$ -axis to which we affect the resistivity identified  
 412 underneath the sensor (the surveyed area) is sufficient to model the medium.

413 The parameters of the problem used in the following sections are the resistivities of the  
 414 blocks.

415 To illustrate the importance of considering the true geometry for defining the  $z$ -coordinate to  
 416 display the apparent resistivity, we compare the sensitivities of the electric potential differences

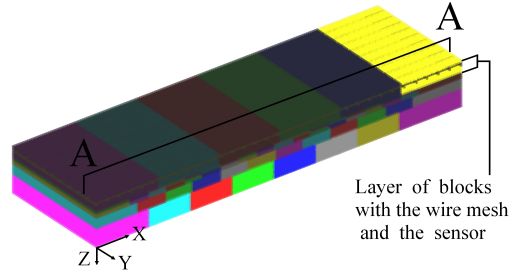
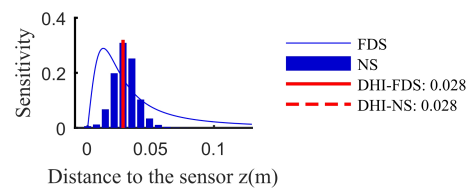

Figure 11: Model of the monitored concrete structure: example of distribution of the blocks for the modeling of the resistivity with equivalent influence on the measurements.

417 obtained in both cases: analytically with the Frechet derivatives on the semi-infinite medium  
 418 and numerically on the more realistic geometry of the surveyed part of the concrete structure  
 419 presented above. Figure 12 shows the sensitivities for three different distances of the electrodes:  
 420 35 mm (top Figure), 70 mm (middle Figure) and 105 mm (bottom Figure). The depth at which  
 421 the apparent resistivity is displayed using the Frechet Derivatives Sensitivities (FDS) of the semi-  
 422 infinite case, that is half of the integral of the sensitivity curve, is represented with a solid red line.  
 423 The one obtained numerically by considering the more realistic geometry is represented with a  
 424 dashed red line. For close distances of 35 mm both sensitivities are in good agreements whereas  
 425 the electrodes are distant, the numerical sensitivity has a bimodal distribution contrary to the  
 426 semi-infinite case. This shows that we do not probe the medium only far away from the sensor  
 427 but also the medium close to the sensor. This is due to the actual conditions of the surveyed area  
 428 especially that of the underside of the concrete.

429 Since the part of the structure containing the steel reinforcement above the wire mesh is not  
 430 part of the structure we want to study, the numerical model is also used to make sure the sensor is  
 431 not sensitive to that upper part (and so not sensitive to the steel reinforcement), or in other words  
 432 to make sure that the 35 mm wire mesh is well designed to prevent current from flowing to the  
 433 other side of the wire mesh. To that aim, we have considered an enlarged domain of concrete by  
 434 adding a layer of concrete above the wire mesh in the numerical model and we have analyzed  
 435 its effects on the electric potential differences. Figure 13 shows the modeling with the layer of  
 436 concrete above the wire mesh. The electric potential differences is sensitive to the lower part  
 437 of the domain with a sensitivity index  $S_{lower} \approx 1$  and to the upper part of the domain with a  
 438 sensitivity index  $S_{upper} \approx 2.10^{-8}$  assessed numerically. The experimental setup thus fulfills the



a) Sensitivity for a 35 mm distance between electrodes

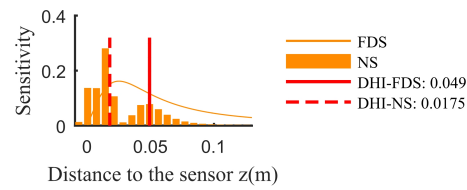

b) Sensitivity for a 70 mm distance between electrodes

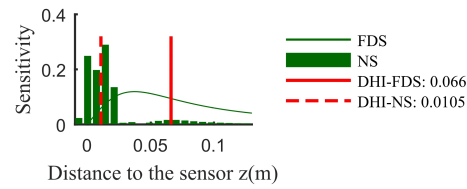

c) Sensitivity for a 108 mm distance between electrodes

Figure 12: Sensitivity of the measurement with respect to the depth obtained analytically on the semi-infinite medium (FDS: Frechet Derivatives Sensitivity) and numerically on the more realistic geometry (NS: Numerical sensitivity). The red lines locate the half of the integral of the sensitivity (DHI).

439 requirements.

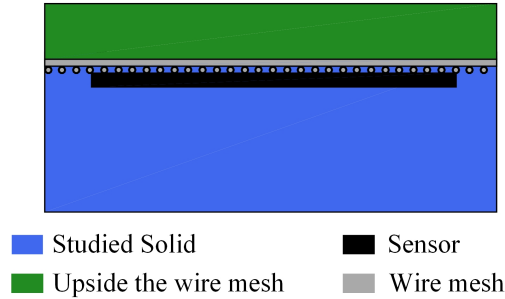

Figure 13: Section A-A of the model used to study the influence of the part above the wire mesh.

#### 440 4.4. Validation of the method for displaying of the apparent resistivity

441 The method is validated on experimental and numerical cases for which the resistivity field is  
442 known *a priori*. The displayed apparent resistivity obtained with the proposed method is viewed  
443 to verify the similarity between the imposed and the displayed apparent resistivities first in a  
444 homogeneous medium and then in non homogeneous ones. In the following, the resistivity is  
445 displayed in the 2D section A-A drawn in Figure 11. The ordinate axis will correspond to the  
446 distance to the underside of the monitored concrete part and is equal to  $h - z$ , with  $z$  the distance  
447 to the sensor (as in section 4.1) and  $h = 0.12$  m the distance of the sensor to the underside.

##### 448 4.4.1. Tests on homogeneous medium

449 Let first consider the numerical model governed by equations (8) with constant resistivity  
450  $\rho = 80 \Omega\text{m}$  in the whole domain. The apparent resistivity coefficients  $\rho_{app,i}$  (Figure 14b) obtained  
451 with equation (7) for 62 blocks and using the geometric factors assessed numerically is compared  
452 to the imposed homogeneous resistivity (Figure 14a). As expected, looking at the displayed  
453 apparent resistivity  $\rho_{app,i}$  in the homogeneous case, the uniform resistivity is recovered to the  
454 machine precision.

455 On Figure 14a, the dashed line defines the domain, joined underneath the sensor, the resistiv-  
456 ity of which is the most influent on the measurements of electrical potential differences. As the  
457 outer part is not influent on the measurements, it is removed from the plots in the following.

458 Same comparison is performed on two experimental cases with supposed homogeneous  
459 source water of resistivity  $23 \Omega\text{m}$  and mixture of source and distilled water of resistivity  $92$   
460  $\Omega\text{m}$ . Figure 15 displays the apparent resistivities  $\rho_{app,i}$  obtained with equation (7) for 46 blocks

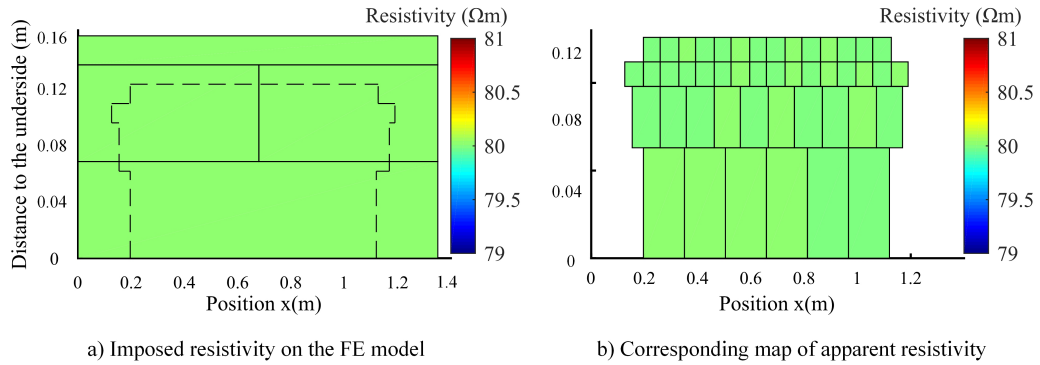

Figure 14: (a) Original resistivity imposed on the finite element model. (b) Pseudo section of apparent resistivity display by the method.

461 in the influent domain. Figures 15a and b plot the results for the medium of resistivity 23  $\Omega\text{m}$  and  
 462 92  $\Omega\text{m}$  respectively. Again in both cases the apparent resistivity is similar to the homogeneous  
 463 resistivity of the water.

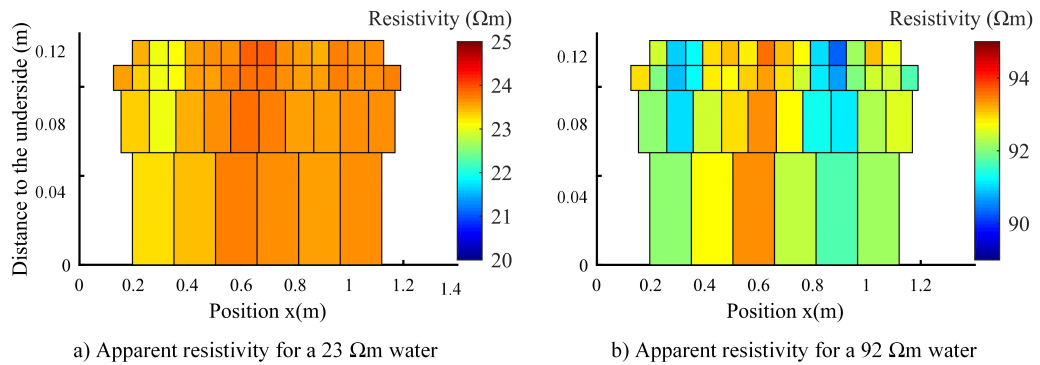

Figure 15: Pseudo section of resistivity for homogeneous mixtures of water. (a) source water with resistivity 23  $\Omega\text{m}$  and (b) mixture of source and distilled water with resistivity 92  $\Omega\text{m}$ .

#### 464 4.4.2. Heterogeneous medium

465 Additional tests have been carried out on the numerical model with known imposed non  
 466 homogeneous resistivity field. Figures 16 and 17 present results of the display method on two  
 467 cases where the imposed resistivities have vertical and horizontal gradients respectively (left  
 468 Figures). The corresponding displayed apparent resistivity  $\rho_{app,i}$  (right Figures) for 46 blocks  
 469 in the influential domain are plotted in the right Figures. Although the values of the original  
 470 resistivities are not exactly recovered because of the heterogeneity of the resistivity field, the



471 display method is able to catch the trends of the original resistivity. The proposed display method  
 472 is found efficient as these results are consistent with those obtained in geophysics in semi-infinite  
 473 media and using Frechet Derivatives.

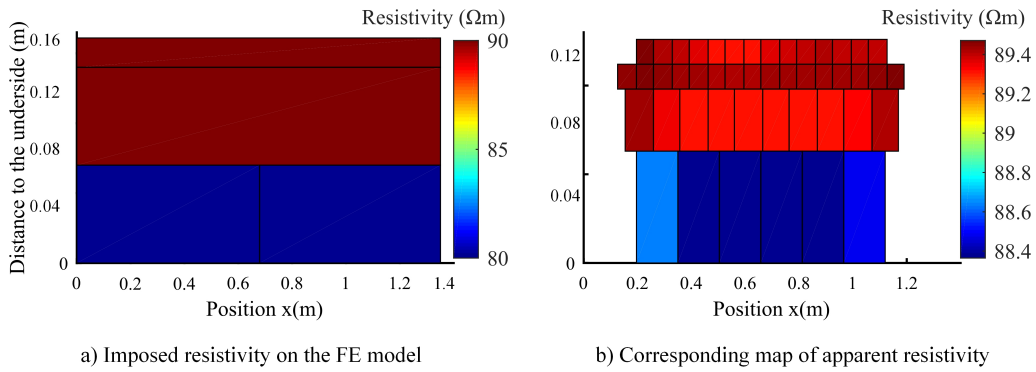

Figure 16: Original resistivity with vertical gradient imposed on the finite element model (a) and corresponding map of apparent resistivity displayed by the proposed method (b).

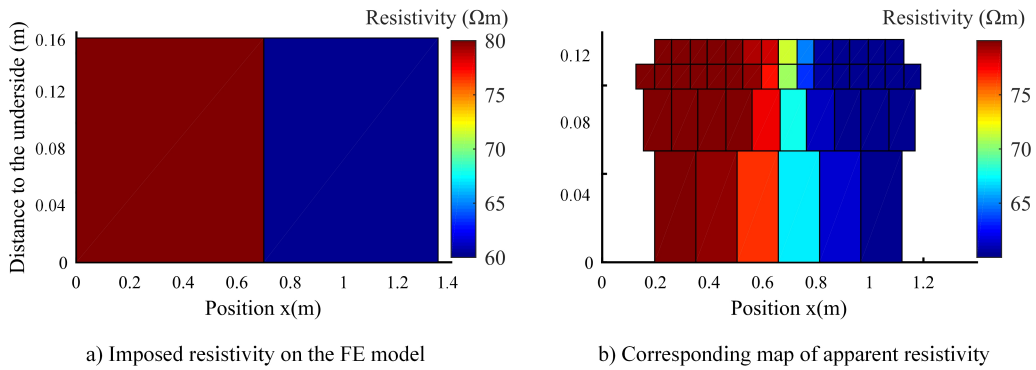

Figure 17: Original resistivity with horizontal gradient imposed on the finite element model (a) and corresponding map of apparent resistivity displayed by the proposed method (b).

474 The mapping for displaying the apparent resistivity could also be adapted to other parametriza-  
 475 tion methods. For instance one can refine the block distribution of the apparent resistivity but the  
 476 computation cost becomes quickly unaffordable when the number of parameters increases.

## 477 5. Results and discussion

### 478 5.1. In situ Monitoring of temperature and humidity

479 The on-site temperature measurement is a crucial data needed for the correction of the re-  
 480 sistivity measurements [31, 32, 24] and an input for the maturity method. Figure 19 gives the

481 evolution of the temperature during the whole duration of the study. The measurements of the  
 482 3 sensors Pt11, Pt12 and Pt13 are very close showing a homogeneous distribution of the tem-  
 483 perature along the beam. Daily variations (day-night cycles) and seasonal variations are visible  
 484 respectively on Figures 18 and 19. On the same beam, the relative humidity measured in concrete  
 485 in the lower zone is shown in Figure 18 and Figure 19.

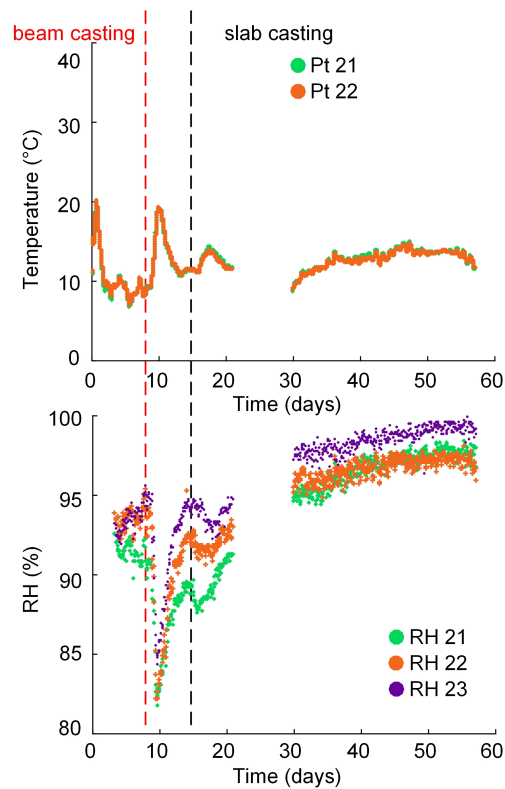

Figure 18: Monitoring of temperature and relative humidity (RH) in beam 2 with time (0 to 60 days).

486 The structure was cast in three steps. The part containing the sensors was filled on day 0 and  
 487 a first temperature peak appears about 12 hours later (see Figure 18). The central part of the beam  
 488 was cast 9 days later. This operation is visible in Figure 18 where a second temperature peak  
 489 reaches 20°C. Finally, a few days later, the slab is cast, which has the effect of slightly modifying  
 490 the temperature in the lower part of the beam.

491 Relative humidity records begin 48 hours after concrete casting in the lower part of the beam.  
 492 The humidity probes are positioned in concrete openings recapped immediately after insertion

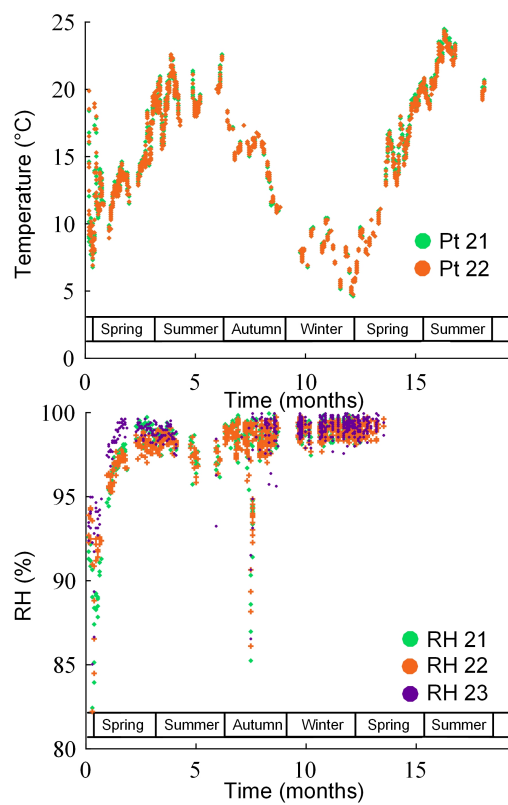

Figure 19: Monitoring of temperature and relative humidity (RH) within beam 2 with time (0 to 18 months).

493 of the sensors. It is therefore a measure of the relative humidity inside a cavity of a few cubic  
494 centimeters (about  $10 \text{ cm}^3$ ) in the concrete, but not a direct measure of water content in the poros-  
495 ity. The main information is that despite of temporary decreases, linked to the occasional rise  
496 in temperature (during chemical reaction of the cement paste), the relative humidity increases in  
497 the cavity to stabilize around 98% on day 50 (see Figure 18) then remains between 95 and 100%  
498 (Figure 19). The water content of concrete is high as the underside elements of the structure  
499 are regularly submerged or splashed during tidal cycles. A decrease of this relative humidity to  
500 95% occurred during the first summer (see Figure 19). This is an important indication that should  
501 be taken into account when analyzing resistivity measurements. Indeed, a concrete with a high  
502 water content naturally has a low resistivity.

## 503 5.2. Material parameters

### 504 5.2.1. Porosity

505 The porosity of the concrete used *in situ* has been estimated at 12% according to the French  
506 standard NF P18-459 as mentioned in section 2.5. This porosity value is relatively low [36].  
507 Porosity is one of main general durability indicators that can be used to estimate the durability  
508 of concrete structures exposed to chlorides. The determination of porosity is actually necessary  
509 to deduce the water saturation of concrete and its chloride content.

### 510 5.2.2. Compressive strength

511 To determine the activation energy, following equation (1), data are analyzed at the end of the  
512 first day, since during 24 hours all specimens have been stored at the same temperature. Figure 20  
513 shows the influence of the curing temperature on the compressive strength and Figure 21 shows  
514 the time-temperature transformation based on the calculation of equivalent age. The bars on the  
515 graph represent the standard deviation of three experimental measurements.

516 The value of activation energy  $E_a$  deduced from the superposition method was 24.4 kJ/mol.  
517 This value was used to assess equivalent time  $\tau(t; T, T_{ref})$  with  $T_{ref} = 20 \text{ }^\circ\text{C}$  for the specimens  
518 cured at  $T = 10 \text{ }^\circ\text{C}$  and  $T = 45 \text{ }^\circ\text{C}$  and then the equivalent age  $\tau(t; T, T_{ref})$  of the *in situ* concrete  
519 as well as the value of *in situ* concrete strength  $f_c(t; T, T_{ref})$  (see Figure 21). We clearly see  
520 the logarithmic model trend of the compressive strength with the equivalent time whatever the  
521 temperature. The calculation is possible for all regions equipped with a temperature sensor. [47].

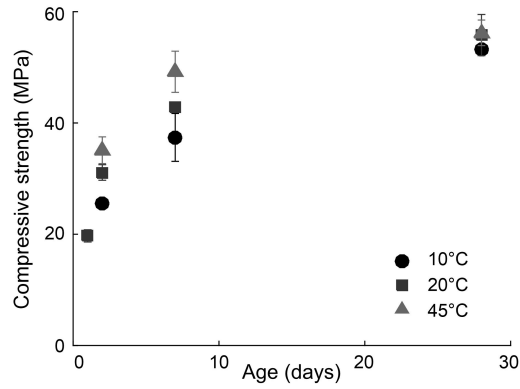

Figure 20: Compressive strength of concrete specimens as a function of the time  $t$  for three different curing temperatures  $T = 10\text{ }^{\circ}\text{C}$ ,  $20\text{ }^{\circ}\text{C}$  ( $T_{ref}$ ) and  $45\text{ }^{\circ}\text{C}$ .

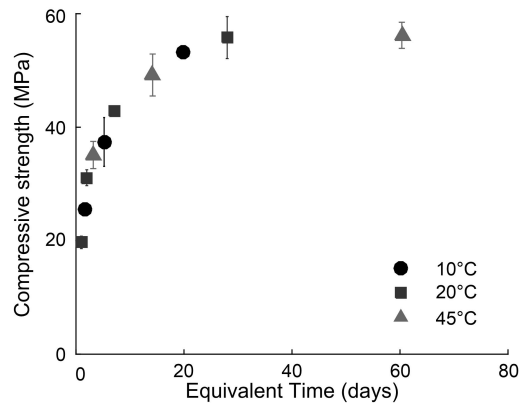

Figure 21: Compressive strength  $f_c(t; T, T_{ref})$  of concrete specimens as a function of the equivalent time  $\tau(t; T, T_{ref})$  for three different curing temperatures  $T = 10\text{ }^{\circ}\text{C}$ ,  $20\text{ }^{\circ}\text{C}$  ( $T_{ref}$ ) and  $45\text{ }^{\circ}\text{C}$ .

522 5.3. Evolution of average resistivity

523 First, we analyze the evolution of the average apparent resistivity measured in the volume  
 524 below a resistivity sensor. The apparent resistivity measurements in beam 1, under the RS21 and  
 525 RS22 sensors, has thus been plotted over time in Figure 22. The average of the 117 measurements  
 526 made with a sensor is calculated to obtain the constituent points of this curve. The error bar  
 527 symbolizes the standard deviation of all the resistivity measurements yielded by the considered  
 528 sensor.

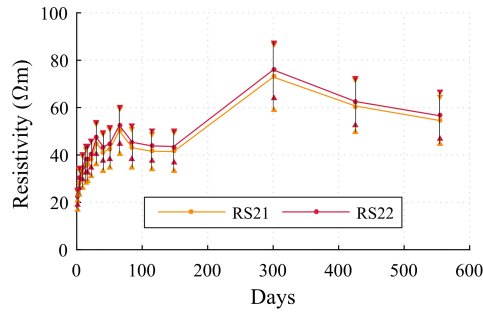

Figure 22: Measured resistivity *in situ*  $\rho_T$ .

529 These data cannot be used directly. The signal is noisy due to thermal effects. It should  
 530 therefore be corrected. One technique is to calculate the average apparent resistivity at a reference  
 531 temperature  $T_{\text{ref}}$  (here 20 °C), according to equation (9):

$$\rho_T = \frac{\rho_{T_{\text{ref}}}}{1 + \alpha (T - T_{\text{ref}})} \quad (9)$$

532 where  $\rho_T$  is the apparent resistivity measured at the temperature  $T$  and  $\rho_{T_{\text{ref}}}$  is the apparent resis-  
 533 tivity computed for the temperature  $T_{\text{ref}}$ . The coefficient  $\alpha$  is a correction factor of temperature  
 534 effects which is set here at 0.022 °C<sup>-1</sup> as proposed by Whittington and al.[6].

535 We chose 20 °C for the reference temperature since it is the temperature commonly used in  
 536 the literature for resistivity correction and also because it is the temperature used for the equiv-  
 537 alent time calculation for material hardening. The corrected curves are plotted on Figure 23.  
 538 After the thermal correction, the resistivity evolutions are similar to those described by the au-  
 539 thors who performed resistivity measurement in laboratory on concrete specimens [13, 11]. This  
 540 result contributes to validate the relevance of the measurements obtained with the *in situ* device  
 541 and the need for temperature measurement. It can also be noted that the two sensors embedded  
 542 in the same beam about 20 cm far from each other, give very similar apparent resistivities.

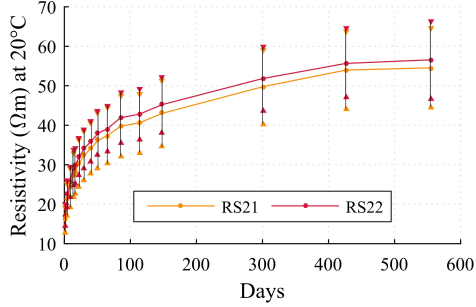

Figure 23: Resistivity  $\rho_{T_{ref}}$  computed at 20 °C.

543 An interesting property of the resistivity comes from its link to porosity. The porosity evolves  
 544 with hydration [37] thus modifying the resistivity value. Since, the mechanical strength of con-  
 545 crete is influenced by porosity, the resistivity measurement can be considered as an indicator  
 546 of material hardening. This appears clearly on Figure 24 on which the mechanical strength is  
 547 plotted as a function of the average electrical resistivity. The relationship between these two  
 548 quantities is a linear relationship with a correlation coefficient very close to 1.

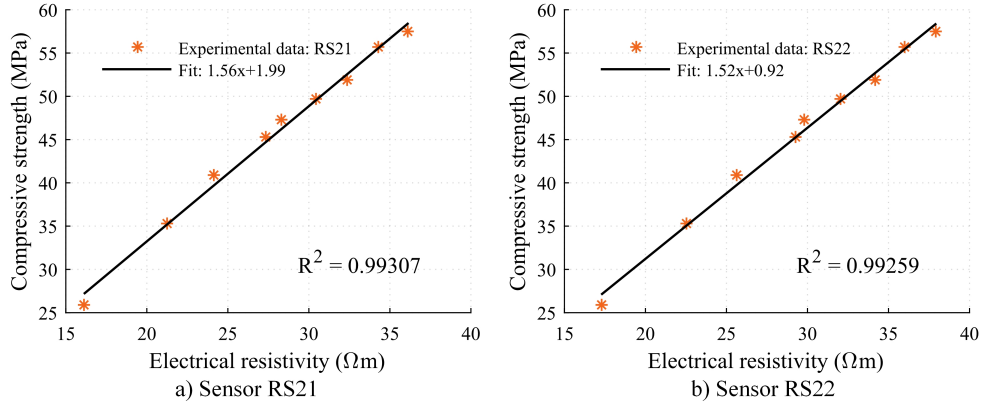

Figure 24: Evolution of compressive strength  $f_c(t; T, T_{ref})$  as a fonction of electrical resistivity  $\rho_{T_{ref}}$  for  $T_{ref} = 20$  °C.

549 According to Archie [4], the electrolytic resistivity of the material is given by the following  
 550 empirical law:

$$\rho = a\rho_w\Phi^{-m}S_r^{-n} \quad (10)$$

551 with  $\rho$  the electrolytic resistivity of concrete (in  $\Omega.m$ ),  $\rho_w$  the resistivity of the interstitial

552 solution (temperature dependent),  $\Phi$  the porosity of the material,  $S_r$  the degree of saturation, and  
553 where  $a$ ,  $m$  and  $n$  are material parameters.

554 In this study it is assumed that the concrete is saturated with water. This assumption seems  
555 reasonable considering the environment of the structure and the relative humidity measurements  
556 made in the concrete beams. Indeed, the relative humidity variations are low and RH% remains  
557 very high over time. So  $S_r$  is considered equal to 1 in equation 10.

558 The electrical resistivity of a water-saturated concrete is then a function of the following  
559 parameters: pore volume, porous connectivity, cement type (here the same for the two beams),  
560 degree of hydration and chemical composition of the pore solution (parameter  $\rho_w$ ).

561 In a healthy concrete, in the absence of chlorides, the influence of the chemical composition  
562 of the pore solution remains small if the solution remains alkaline [36] and thus  $\rho_w$  does not  
563 vary. The electrical current propagates mainly through the saturated porous network. The most  
564 influent parameter on resistivity measurement is therefore the connectivity of the pore network  
565 (since the influence of temperature has been previously corrected). The measurement of elec-  
566 trical resistivity is therefore a simple way to characterize indirectly the connectivity of a porous  
567 saturated medium  $\Phi^{-m}$ . For a given cement paste, the reduction of porosity due to the hydration  
568 of cement results in the same time in a decrease in pore connectivity, and an increase in strength.  
569 The morphology of cement paste depends on cement type and concrete composition, thus there  
570 is not a general correlation between resistivity and strength (see [48]). Here the same concrete  
571 was used for both measurements. This explains the excellent correlation between the mechanical  
572 strength measurement and the resistivity measurement observed in Figure 24.

573 On Figure 25, the compressive strength  $f_c(t; T, T_{ref})$  is drawn together with the resistivity  $\rho_{T_{ref}}$   
574 as a function of equivalent time  $\tau$ . Both curves exhibit a similar evolution. They have especially  
575 similar inflection. As a consequence, when the resistivity has reached its asymptotical value, it  
576 can be said that the concrete has almost reached its maximum compressive strength.

577 Simultaneous monitoring of the evolutions of the mechanical properties of concrete and of the  
578 resistivity shows that resistivity sensors could be used as part of a strategy to optimize the phasing  
579 of the construction process. Obtaining such a result *in situ*, already known and documented in  
580 laboratory tests, is particularly interesting because it reinforces the interest of using an embedded  
581 resistivity measurement device at early age and not only for chloride assessment. Indeed, both the  
582 constructor of the structure, within the framework of the monitoring of manufacturing processes,



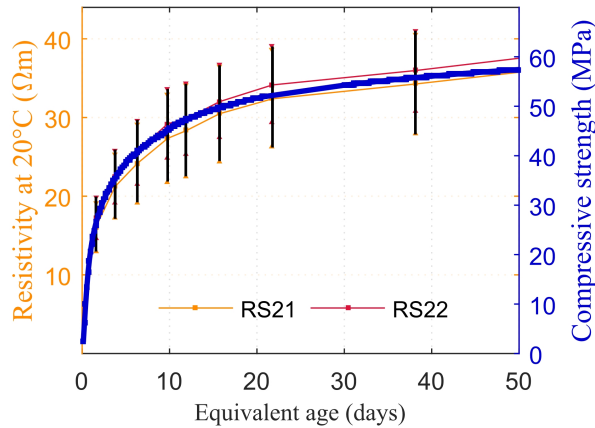

Figure 25: Evolutions of compressive strength  $f_c(t; T, T_{ref})$  and of electrical resistivity  $\rho_{T_{ref}}$  as functions of equivalent age  $\tau$  for  $T_{ref} = 20^\circ\text{C}$ .

583 and the owner of the structure, within the framework of the ageing structure survey, could find  
 584 an advantage in using this measuring system which reinforces the interest of *in situ* installation  
 585 of DC measurement devices.

#### 586 5.4. Displaying the pseudo-sections of apparent resistivities

587 The pseudo-sections of apparent resistivities displayed following the procedure described  
 588 in section 4.2 are presented in Figure 26 for days 2, 30 and 426 after concrete casting. The  
 589 appearance of the pseudo resistivity sections displayed with a given sensor is very similar from  
 590 one day to another in terms of gradients.

591 It can also be noted that the dispersion of the resistivity measurements around the mean value  
 592 is much higher than that observed in the water and also much higher than the repeatability error  
 593 measured *in situ* in concrete (see section 3.2). The variability of apparent resistivities cannot  
 594 therefore be explained solely by measurement errors. This variability in resistivity is related  
 595 to the heterogeneity of the material; the most likely explanation is the variability of porosity.  
 596 This would explain why the facies of the resistivity maps change only slightly over time once  
 597 the main chemical reactions have occurred during the very first days of concrete setting and  
 598 hardening. Conversely, as shown in the previous section, the average resistivity value increases  
 599 with time which is also consistent with the porosity evolution.

600 Furthermore, it can be noted that the values of apparent resistivity are very low. Although it is  
 601 not possible to state that concrete is saturated with water only on the basis of a relative humidity

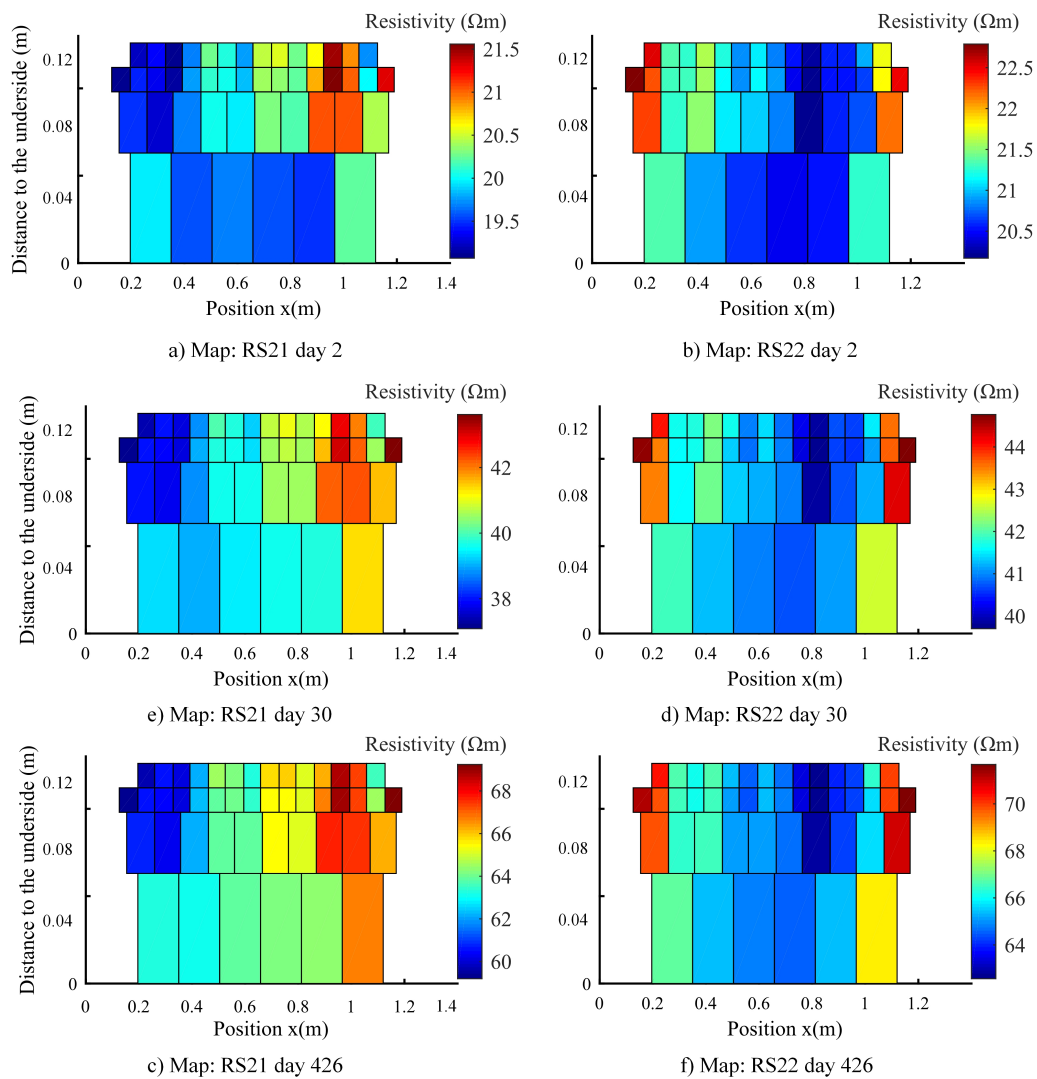

Figure 26: Pseudo sections of resistivity. From left to right: RS21 and RS22 sensors. From top to bottom: days 2, 30 and 426.

602 measurement in a cavity, the water content of concrete is likely to be very high. This assumption  
 603 is consistent with the low resistivity values measured on site while the porosity of the concrete  
 604 measured in laboratory is low (see section 5.2). The values of the resistivities found here are also  
 605 consistent with the observations of previous work on the topic[13, 49].

606 An indicator of corrosion probability based solely on the evolution of the average resistivity  
 607 value does not seem to be the most appropriate choice for application to a port or offshore struc-  
 608 ture if one refers to the observations made on the wharf (porosity, resistance, relative humidity,  
 609 temperature and resistivity measurement). Since a pseudo section of apparent resistivity appears  
 610 to be a characteristic of the material properties in a given area, it is proposed to study the differ-  
 611 ence between the pseudo sections at two different times. This difference is shown on the Figure  
 612 27 on which the resistivity difference obtained for the two sensors RS21 and RS22 on days 114  
 613 and 148 is displayed (difference and relative difference).

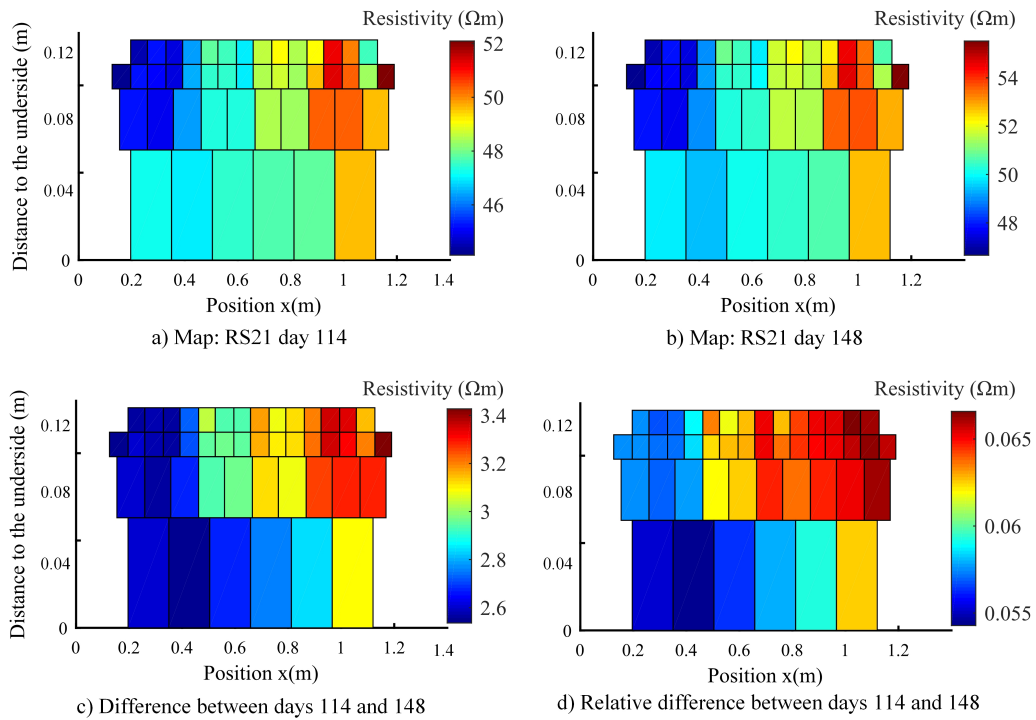

Figure 27: Pseudo section of difference of resistivity. Left: difference of the resistivity of the RS21 sensor between the days 114 and 148. Right: relative difference of the resistivity of the RS21 sensor between the days 114 and 148.

614 The difference between the apparent resistivities measured on days 114 and 148 is positive

615 at any point of the pseudo section of apparent resistivity. This is an expected result and this  
616 result was found for all ages and sensors. Over time, the water content of concrete is expected  
617 to decrease rapidly after the dormant period and then to decrease more and more slowly as the  
618 hydration of cement consumes water. A local decrease in resistivity between two time periods  
619 (excluding artifacts related to poor temperature compensation) would mean that the concrete  
620 has become wetter or that its chemical composition has changed (for example, due to chloride  
621 ion penetration). The sign of the difference between two pseudo sections of apparent resistivity  
622 appears to be a good indicator of early detection of corrosion. It should be noted, however,  
623 that with a pseudo section of apparent resistivity, it would not be possible to accurately define  
624 the size of the affected area and its precise distance from the surface. However, this is a good  
625 indicator to state almost instantly, - within the framework of a sensor integrated into an SHM  
626 chain - and with great certainty that concrete is evolving and that monitoring in the area must  
627 be strengthened. Further actions could then be done. In some cases coring concrete specimens  
628 could be necessary.

## 629 **6. Conclusion and outlook**

630 Electrical resistivity measurements are currently used in the field of inspection of civil en-  
631 gineering structure, mainly as part of a one-time measurement campaign using portable Wenner  
632 probes. The performance of these devices is limited by the difficulty of obtaining repeatable  
633 contact between the electrode and the concrete surface on the one hand and by the presence of  
634 reinforcement on the other hand. The intrinsic heterogeneity of concrete also complicates the  
635 analysis of measurements, making it difficult to interpret localized measurements.

636 Embedded sensors in concrete structures during casting solves the problem of poor repeata-  
637 bility measurement induced by resistance contact between concrete and electrode. However, the  
638 problem of taking into account the influence of the presence of reinforcements on the measure-  
639 ment remains. This topic is the subject of current work with variable solutions depending on the  
640 nature and geometry of the measuring device used [13, 50, 30]. The first objective of this paper  
641 was to propose an installation methodology of a multi-electrode sensor embedded in concrete to  
642 avoid the influence of reinforcements on measurements. To that aim, the resistivity sensor was  
643 attached to a wire mesh that confines the electric current in the concrete cover area. In this study,  
644 we chose to use a multi-electrode sensor about one meter long interrogated with a Wenner alpha

645 protocol to obtain a hundred resistivity measurements in the monitoring area. All the measures  
646 available thus allow the intrinsic heterogeneities of the concrete studied to be taken into account.  
647 The evolution of the average resistivity value over time was compared with the evolution of the  
648 mechanical strength of *in situ* concrete estimated using the maturometry method. This *in situ* re-  
649 sult tends to prove the relevance of the proposed method of sensor installation and calibration and  
650 also opens the perspective to use resistivity measurement, not only within the framework of age-  
651 ing survey but also within the framework of concrete hardening monitoring for the optimization  
652 of the construction process.

653 Then, the second goal of this article was to propose a method for analyzing and displaying  
654 resistivity measurements in the form of a pseudo section of apparent resistivity. It is based on the  
655 numerical evaluation of the sensitivity of potential measurements to resistivity variations in pre-  
656 defined volume blocks according to their influence on the measurements. The methodology has  
657 been validated and applied to the analysis of resistivity measurements performed on a new port  
658 wharf for 18 months. The heterogeneous and random nature of the resistivity was attributed to the  
659 heterogeneity of the porosity of the concrete. It was thus considered that these maps presented  
660 information intrinsic to each studied zone and proposed an indicator of corrosion probability  
661 based on the study of the difference between two pseudo-sections of apparent resistivity. Since it  
662 allows instant visualization of results, the display of apparent resistivity maps can be integrated  
663 into an *in situ* measurement system or into a structure supervision system. If an anomaly is de-  
664 tected by comparing the apparent resistivity sections between two days, several actions can be  
665 taken, including coring or computation of the true resistivity for a more accurate location of the  
666 anomaly. In this case, the apparent resistivity can be used for initialization in the optimization  
667 algorithms for the identification of the true resistivity. With the methodology proposed here, it  
668 is possible to provide a set of initial parameters close to the final solution, which contributes to  
669 improving the efficiency of inversion algorithms.

670 Resistivity is an indirect indicator of corrosion. When the resistivity value is below a thresh-  
671 old value, the probability of corrosion initiation is considered high. The use of on-site resistivity  
672 is in most cases limited to the detection of risk areas. To obtain reliable information on the  
673 corrosion of the reinforcement and the position of the chloride front, destructive tests (chloride  
674 titration) are traditionally carried out.

675 It is possible to further exploit the information provided by the resistivity measurement in

676 order to characterize the degree of corrosion, through the relationships between:

677

- 678 • the resistivity value and the chloride content [51];
- 679 • the resistivity value and the value of the diffusion coefficient of chloride ions in concrete  
680 [38, 14] ;
- 681 • the resistivity value and the current corrosion value [52].

682 Associated together, the value of the chloride rate in a given area and the diffusion coefficient  
683 of chloride in concrete make it possible to obtain predictions over structure life duration by  
684 calculation [52].

685 The measurement of the corrosion current is a direct indicator. It will be interesting during the  
686 service life of the structure to compare the resistivity measurements and the predicted advance  
687 of the chloride front with measurements of reinforcement electric potential. This study will be  
688 the continuation of this work.

## 689 **Acknowledgment**

690 The authors would like to thank all the partners of iMAREO2 project: Keops Automation  
691 (D. Follut, D. Olivier), Université de Nantes (M. Roche), Nantes – Saint Nazaire Port (P. Lijour,  
692 M. Labégorre) and Bouygues Construction (the teams of Bouygues Travaux Publics Régions  
693 France). The authors would like to thank the Pays de la Loire region for its financial support.

## 694 **References**

- 695 [1] Harsh K. Gupta, editor. *Encyclopedia of Solid Earth Geophysics*. Encyclopedia of Earth Sciences Series. Springer  
696 Netherlands, 2011.
- 697 [2] M.H. Loke. Electrical imaging surveys for environmental and engineering studies A practical guide to 2-D and 3-D  
698 surveys. Technical report, 2000.
- 699 [3] W.M. Telford, P.L. Geldart, and R.E. Sheriff. *Applied geophysics 2nd edition | Solid earth geophysics*. Cambridge  
700 University Press, 1991.
- 701 [4] G. E. Archie. The Electrical Resistivity Log as an Aid in Determining Some Reservoir Characteristics. *Transactions*  
702 *of the AIME*, 146(01):54–62, December 1942.
- 703 [5] G. E. Archie. Classification of Carbonate Reservoir Rocks and Petrophysical Considerations. *AAPG Bulletin*,  
704 36(2):278–298, 1952.
- 705 [6] H. W. Whittington, J. McCarter, and M. C. Forde. The conduction of electricity through concrete. *Magazine of*  
706 *Concrete Research*, 33(114):48–60, March 1981.
- 707 [7] Samuel Naar. *Evaluation non destructive du beton par mesures de resistivite électrique et thermographie infrarouge*  
708 *passive*. thesis, Bordeaux 1, January 2006.
- 709 [8] J.F. Lataste, C. Sirieix, D. Breyse, and M. Frappa. Electrical resistivity measurement applied to cracking assess-  
710 ment on reinforced concrete structures in civil engineering. *NDT & E International*, 36(6):383–394, September  
711 2003.

- 712 [9] Zhiyong Liu, Yunsheng Zhang, and Qian Jiang. Continuous tracking of the relationship between resistivity and  
713 pore structure of cement pastes. *Construction and Building Materials*, 53:26–31, February 2014.
- 714 [10] M. Saleem, M. Shameem, S. E. Hussain, and M. Maslehuiddin. Effect of moisture, chloride and sulphate contamina-  
715 tion on the electrical resistivity of Portland cement concrete. *Construction and Building Materials*, 10(3):209–214,  
716 April 1996.
- 717 [11] Wolfgang Brameshuber, Christoph Dauberschmidt, Petra Schroder, and Michael Raupach. Non-destructive de-  
718 termination of the water content in the concrete cover using the multi-ring-electrode. Technical Report RWTH-  
719 CONV-006116, DGZfP, 2003.
- 720 [12] Effect of moisture content on concrete resistivity measurement. *Journal of the Chinese Institute of Engineers*,  
721 25:117–122, January 2002.
- 722 [13] Rob B Polder. Test methods for on site measurement of resistivity of concrete a rilem tc-154 technical recommen-  
723 dation. *Construction and Building Materials*, 15(2):125–131, March 2001.
- 724 [14] Rob B Polder and Willy H. A Peelen. Characterisation of chloride transport and reinforcement corrosion in concrete  
725 under cyclic wetting and drying by electrical resistivity. *Cement and Concrete Composites*, 24(5):427–435, October  
726 2002.
- 727 [15] W Morris, A Vico, M Vazquez, and S. R de Sanchez. Corrosion of reinforcing steel evaluated by means of concrete  
728 resistivity measurements. *Corrosion Science*, 44(1):81–99, January 2002.
- 729 [16] Jean-François Lataste. *Évaluation non destructive de l'état d'endommagement des ouvrages en béton armé par*  
730 *mesures de résistivité électrique*. Bordeaux 1, January 2002.
- 731 [17] C Andrade, M Castellote, and R d'Andrea. Chloride aging factor of concrete measured by means of resistivity.  
732 Porto Portugal, April 2011.
- 733 [18] Yann Lecieux, Franck Schoefs, Stéphanie Bonnet, Trystan Lecieux, and Sergio Palma Lopes. Quantification and  
734 uncertainty analysis of a structural monitoring device: detection of chloride in concrete using DC electrical resis-  
735 tivity measurement. *Nondestructive Testing and Evaluation*, 30(3):216–232, July 2015.
- 736 [19] Yanbo Liu, Francisco Presuel-Moreno, and Mario Paredes. Determination of Chloride Diffusion Coefficients in  
737 Concrete by Electrical Resistivity Method. *ACI Materials Journal*, 112(5), October 2015.
- 738 [20] Milia Fares, Géraldine Villain, Stéphanie Bonnet, Sergio Palma Lopes, Benoit Thauvin, and Mickael Thiery. Deter-  
739 mining chloride content profiles in concrete using an electrical resistivity tomography device. *Cement and Concrete*  
740 *Composites*, 94:315–326, November 2018.
- 741 [21] Pejman Azarsa and Rishi Gupta. Electrical Resistivity of Concrete for Durability Evaluation: A Review. *Advances*  
742 *in Materials Science and Engineering*, 2017:1–30, 2017.
- 743 [22] Jean-François Lataste, Géraldine Villain, and Jean-Paul Balaýssac. Electrical Methods. In *Non-Destructive Testing*  
744 *and Evaluation of Civil Engineering Structures*, pages 139–172. Elsevier, 2018.
- 745 [23] R. du Plooy, S. Palma Lopes, G. Villain, and X. Dérobert. Development of a multi-ring resistivity cell and multi-  
746 electrode resistivity probe for investigation of cover concrete condition. *NDT & E International*, 54(Supplement  
747 C):27–36, March 2013.
- 748 [24] W. J. McCarter, T. M. Chrisp, G. Starrs, P. A. M. Basheer, and J. Blewett. Field monitoring of electrical conductivity  
749 of cover-zone concrete. *Cement and Concrete Composites*, 27(7):809–817, August 2005.
- 750 [25] J.F. Lataste, T. De Larrard, F. Benboudjema, and J. Semenadisse. Study of electrical resistivity: variability assess-  
751 ment on two concretes: protocol study in laboratory and assessment on site. *European Journal of Environmental*  
752 *and Civil Engineering*, 16(3-4):298–310, April 2012.
- 753 [26] J-F. Lataste and D. Breyse. A Study on the Variability of Electrical Resistivity of Concrete. In Gunes Oguz and  
754 Yillmaz Akkaya, editors, *Nondestructive Testing of Materials and Structures*, pages 255–261. Springer Nether-  
755 lands, Dordrecht, 2013.
- 756 [27] Lucas Bourreau. *Diagnostic de corrosion sur ouvrage : fiabilité et aide à la décision*. Nantes, December 2017.
- 757 [28] Ueli M. Angst and Rob Polder. Spatial variability of chloride in concrete within homogeneously exposed areas.  
758 *Cement and Concrete Research*, 56:40–51, February 2014.
- 759 [29] S G Millard and WENNER. REINFORCED CONCRETE RESISTIVITY MEASUREMENT TECHNIQUES.  
760 *Proceedings of the Institution of Civil Engineers*, 91(1):71–88, March 1991.
- 761 [30] Gabriel Samson, Fabrice Deby, Jean-Luc Garciaz, and Jean-Louis Perrin. A new methodology for concrete resis-  
762 tivity assessment using the instantaneous polarization response of its metal reinforcement framework. *Construction*  
763 *and Building Materials*, 187:531–544, October 2018.
- 764 [31] T. M. Chrisp, G. Starrs, W. J. McCarter, E. Rouchotas, and J. Blewett. Temperature-conductivity relationships for  
765 concrete: An activation energy approach. *Journal of Materials Science Letters*, 20(12):1085–1087, 2001.
- 766 [32] Marta Castellote, Carmen Andrade, and Mari Cruz Alonso. Standardization, to a Reference of 25 C, of Electrical  
767 Resistivity for Mortars and Concretes in Saturated or Isolated Conditions. *Materials Journal*, 99(2):119–128,  
768 March 2002.
- 769 [33] N. Wiwattanachang and P.H. Giao. Monitoring crack development in fiber concrete beam by using electrical  
770 resistivity imaging. *Journal of Applied Geophysics*, 75(2):294–304, October 2011.

- 771 [34] P. K. Mehta. CONCRETE. STRUCTURE, PROPERTIES AND MATERIALS. 1986.
- 772 [35] RILEM Technical Committee 108. *Interfacial transition zone in concrete: state-of-the-art report*. E & FN Spon,  
773 London New York, 1996.
- 774 [36] Véronique Baroghel-Bouny. Conception des bétons pour une durée de vie donnée des ouvrages. Technical report,  
775 Association Française de Génie Civil, 2004.
- 776 [37] Nicolas Burlion, Frédéric Bourgeois, and Jian-Fu Shao. Effects of desiccation on mechanical behaviour of concrete.  
777 *Cement and Concrete Composites*, 27(3):367–379, March 2005.
- 778 [38] Ozkan Sengul. Use of electrical resistivity as an indicator for durability. *Construction and Building Materials*,  
779 73:434–441, December 2014.
- 780 [39] Laboratoire central des ponts et chaussées. *Resistance du beton dans l'ouvrage: la maturometrie*. LCPC, Paris,  
781 2003. OCLC: 54835566.
- 782 [40] A. G. A. Saul. Principles underlying the steam curing of concrete at atmospheric pressure. *Magazine of Concrete*  
783 *Research*, 2(6):127–140, March 1951.
- 784 [41] European Committee for Standardisation. Eurocode 2: Design of concrete structures - Part 1-1: General rules and  
785 rules for buildings, 2004.
- 786 [42] P Freiesleben Hansen and E.J. Pedersen. Maleinstrument til Kontrol af betons haerdning. *Nordisk betong*, 1:21–25,  
787 1977.
- 788 [43] Jean Paul Balayssac and Vincent Garnier. *Non-destructive Testing and Evaluation of Civil Engineering Structures*  
789 *- 1st Edition*. ISTE Press - Elsevier, 2017.
- 790 [44] I.M Sobol. Global sensitivity indices for nonlinear mathematical models and their monte carlo estimates. *Mathe-*  
791 *matics and Computers in Simulation*, 55(1-3):271–280, 2001.
- 792 [45] A. Saltelli, P. Annoni, I. Azzini, F. Campolongo, M. Ratto M., and S. Tarantola. Variance based sensitivity analysis  
793 of model output. design and estimator for the total sensitivity index. *Computer Physics Communications*, 181:259–  
794 270, 2010.
- 795 [46] Bruno Sudret. Global sensitivity analysis using polynomial chaos expansions. *Reliability Engineering & System*  
796 *Safety*, 93(7):964 – 979, 2008. Bayesian Networks in Dependability.
- 797 [47] Tahsin Alper Yikici and Hung-Liang (Roger) Chen. Use of maturity method to estimate compressive strength of  
798 mass concrete. *Construction and Building Materials*, 95(Supplement C):802–812, October 2015.
- 799 [48] Ali Akbar Ramezaniapour, Amirreza Pilvar, Mahdi Mahdikhani, and Faramarz Moodi. Practical evaluation of  
800 relationship between concrete resistivity, water penetration, rapid chloride penetration and compressive strength.  
801 *Construction and Building Materials*, 25(5):2472–2479, May 2011.
- 802 [49] A. Lubeck, A.L.G. Gastaldini, D.S. Barin, and H.C. Siqueira. Compressive strength and electrical properties of  
803 concrete with white Portland cement and blast-furnace slag. *Cement and Concrete Composites*, 34(3):392–399,  
804 March 2012.
- 805 [50] Mustafa Salehi, Pouria Ghods, and O. Burkan Isgor. Numerical investigation of the role of embedded reinforce-  
806 ment mesh on electrical resistivity measurements of concrete using the Wenner probe technique. *Materials and*  
807 *Structures*, 49(1-2):301–316, January 2016.
- 808 [51] W Morris, A Vico, and M Vazquez. Chloride induced corrosion of reinforcing steel evaluated by concrete resistivity  
809 measurements. *Electrochimica Acta*, 49(25):4447–4453, October 2004.
- 810 [52] Michael D. A. Thomas and Phil B. Bamforth. Modelling chloride diffusion in concrete: Effect of fly ash and slag.  
811 *Cement and Concrete Research*, 29(4):487–495, April 1999.