



**HAL**  
open science

## Corrosion behaviour of biomedical $\beta$ -titanium alloys with the surface-modified by chemical etching and electrochemical methods

Cesar Adolfo Escobar Claros, Leonardo Contri Campanelli, Alberto Moreira Jorge, Jean-Claude Leprêtre, Claudemiro Bolfarini, Virginie Roche

### ► To cite this version:

Cesar Adolfo Escobar Claros, Leonardo Contri Campanelli, Alberto Moreira Jorge, Jean-Claude Leprêtre, Claudemiro Bolfarini, et al.. Corrosion behaviour of biomedical  $\beta$ -titanium alloys with the surface-modified by chemical etching and electrochemical methods. *Corrosion Science*, 2021, 188, pp.109544. 10.1016/j.corsci.2021.109544 . hal-03482636

**HAL Id: hal-03482636**

**<https://hal.science/hal-03482636v1>**

Submitted on 24 May 2023

**HAL** is a multi-disciplinary open access archive for the deposit and dissemination of scientific research documents, whether they are published or not. The documents may come from teaching and research institutions in France or abroad, or from public or private research centers.

L'archive ouverte pluridisciplinaire **HAL**, est destinée au dépôt et à la diffusion de documents scientifiques de niveau recherche, publiés ou non, émanant des établissements d'enseignement et de recherche français ou étrangers, des laboratoires publics ou privés.



Distributed under a Creative Commons Attribution - NonCommercial 4.0 International License

1 **Corrosion behaviour of biomedical  $\beta$ -titanium alloys with the surface-modified**  
2 **by chemical etching and electrochemical methods**

3

4 Cesar Adolfo Escobar Claros <sup>a, b, \*\*</sup>, Leonardo Contri Campanelli <sup>b, c</sup>, Alberto Moreira  
5 Jorge Junior <sup>a, b</sup>, Jean-Claude Leprêtre <sup>a</sup>, Claudemiro Bolfarini <sup>b</sup>, Virginie Roche <sup>a</sup>

6

7 <sup>a</sup> Univ. Grenoble Alpes, Univ. Savoie Mont Blanc, CNRS, Grenoble INP\*, LEPMI,  
8 38000 Grenoble, France

9 \*Institute of Engineering and Management Univ. Grenoble Alpes

10 <sup>b</sup> Federal University of Sao Carlos, Graduate Program in Materials Science and  
11 Engineering, 13565-905 São Carlos-SP, Brazil

12 <sup>c</sup> Federal University of São Paulo, Institute of Science and Technology, 12231-280  
13 São José dos Campos-SP, Brazil

14

15 **\*\*Corresponding author:** [cesar-adolfo.escobar-claros1@grenoble-inp.fr](mailto:cesar-adolfo.escobar-claros1@grenoble-inp.fr)

16

17

18

19

20

## 1 **Abstract**

2 This work studied the corrosion behaviour of Ti-12Mo-6Zr-2Fe alloy with  
3 different surface conditions: untreated and chemically treated (CST), anodised  
4 nanotubes (Nt) and nanopores (NP). These samples were immersed in simulated  
5 body fluid (SBF) for 1, 7, and 14 days. Samples with Nt and NP displayed higher  
6 corrosion resistance and lower passivation current ( $i_{pass}$ ) than untreated and CST  
7 samples after 14 days resting in SBF. Furthermore, traditional equivalent circuits and  
8 a new two-channel transmission line model were employed to efficiently simulate the  
9 electrochemical impedance spectroscopy (EIS) data of the different surface  
10 conditions.

11 **Keywords:** A. Titanium; B. Polarization; B. EIS; C. Anodic films; C. Passive film.

12

## 13 **1. Introduction**

14 Metallic biomaterials for bone replacement must have four essential  
15 characteristics: a) absence of toxic elements thus leading to adequate  
16 biocompatibility; b) low stress-shielding effect; c) excellent fatigue performance for  
17 cyclically stressed implants, and d) elevated resistance to corrosion [1].

18 Pure titanium and titanium alloys exhibit desirable characteristics, such as  
19 attractive biocompatibility, and adequate corrosion resistance, making them suitable  
20 for use in orthopaedic and dental implants. Traditionally, Ti-6Al-4V-ELI (ELI for  
21 Extra Low Interstitial content) is used to replace commercially pure titanium in  
22 biomedical applications [2]; however, this alloy can fail indirectly due to stress

1 shielding and present toxic reaction with the human body [3,4].In this context, new  
2 alloys with non-toxic elements and lower elastic modulus have been developed, such  
3 as the commercial  $\beta$  Ti-12Mo-6Zr-2Fe alloy (TMZF) with high mechanical strength  
4 and moderate-low elastic modulus [5].

5 Despite the metallurgical and mechanical features, surface treatments are  
6 essential to enhance the osteointegration process of titanium alloys. Previous  
7 studies have demonstrated that HCl etching plus NaOH treatment can be an  
8 effective way to develop nanometric topographies on the Ti-6Al-4V surface,  
9 keeping its static and cyclic mechanical properties [6]. An alternative to CST is the  
10 anodisation process. Anodisation is widely used on pure titanium to create TiO<sub>2</sub>  
11 nanotube layers with nanometric topography that maximises the surface area, thus  
12 leading to better bioactivity [7–10].

13 Corrosion of metallic prosthesis is known to modify their structural integrity and  
14 cause alterations of the surrounding environment, such as changes in pH and  
15 decrease of dissolved oxygen. Furthermore, the metal ions released may cause an  
16 allergic response and be harmful to the patient [11–13]. For these reasons, the study  
17 of corrosion properties is critical and necessary for metallic biomaterials.

18 In recent years, the Electrochemical Impedance Spectroscopy (EIS) has been  
19 successfully applied to polarization resistance measurement and determination of  
20 corrosion mechanisms in different systems [14,15]. Through EIS, it is possible to  
21 obtain information concerning to electrochemical properties of electrolyte and  
22 electrode. Additionally, this technique can discriminate several reactions on the  
23 electrode surface.[16,17].

1       Oxide and porous passive layers show complex impedance responses, and  
2 the understanding of their impedance behaviour is not straightforward. Recently,  
3 different titanium electrodes were studied through impedance using non-traditional  
4 models termed transmission line models (TLM), showing excellent consistency  
5 between experimental and modelled results, and obtained parameters with excellent  
6 reliability [18–20].

7       Therefore, this work aimed at a throughout corrosion study of TMZF surfaces  
8 treated by CST, Nt, and NP and compared to untreated ones. Such a study was  
9 performed in samples immersed by different periods in SBF, which were analysed  
10 by potentiodynamic polarization and electrochemical impedance measurements.

## 11 **2. Materials and methods**

12       The commercial  $\beta$  TMZF alloy produced by ERCATA GmbH was used in this  
13 study. TMZF bars were cut into disks of 10 mm diameter and 1 mm thick, heat-  
14 treated at 800 °C for two hours, and then water quenched to obtain a fully  
15 recrystallised beta phase structure [5].

### 16 *2.1 Surface modification processes*

17       Four different surface conditions were developed on TMZF samples: untreated  
18 surface, surface treated with HCl etching and alkaline NaOH solution (CST), and two  
19 anodised condition – nanotubes (Nt) and nanopores (NP).

20       Before surface modifications, TMZF disks were sequentially ground by SiC  
21 emery papers using the grades P240, P320, P600, P1200, and P2400. After which,  
22 they were conventionally polished using 3 and 1  $\mu\text{m}$  alumina. Deionised water

1 (Milli-Q®), ethanol, and acetone were used to clean the finished surfaces. Such  
2 surface condition was named untreated surface.

3 For the CST, the grounded samples were immersed into an HCl (37 wt.%)  
4 solution heated at 60 °C for 30 min. Samples were individually alkali-treated in 45 ml  
5 NaOH 10 mol•L<sup>-1</sup> contained in polyethylene receptacles. The alkaline solution was  
6 maintained at 60 °C for 24 h. The disks were soaked into deionised water and  
7 sonicated for 10 min, followed by 10 min in acetone.

8 The anodisation processes were carried out in an electrochemical cell with a  
9 conventional two-electrode arrangement. The counter electrode (cathode) was a  
10 cylindrical platinum grid placed ~3 cm away from the polished disks, which were  
11 used as the working electrode (anode). The anodisation processes were performed  
12 at 25 °C in an organic electrolyte consisting of glycerol, containing 25 vol% of water  
13 and 0.25 M of NH<sub>4</sub>F. The DC constant potential applied to produce Nt and NP were  
14 10 V during 2 h, and 20 V during 1 h, respectively. Amorphous as-anodised surfaces  
15 were heat-treated in the air at 550 °C for 2 h, thus crystallising the amorphous TiO<sub>2</sub>  
16 nanostructured surfaces into a rutile/anatase phase mixture [18].

17 The surfaces were inspected in a Zeiss Ultra-55 FEG scanning electron  
18 microscope (SEM). InLens detectors were used to acquire high spatial resolution  
19 images. For such, beam energy of 10 keV and a work distance of ~6 mm was  
20 employed. Additionally, chemical analyses of the different surface treatments were  
21 performed by an X-ray photoelectron spectroscopy (XPS). A Vacuum Generator  
22 XR3E2 apparatus with an Mg-K $\alpha$  X-ray source (characteristic energy  $h\nu = 1273.6$  V)  
23 at 15 kV and 20 mA operating conditions was used to perform the XPS

1 measurement. The binding energies were also calibrated by the C1s hydrocarbon  
2 peak at about 285 eV through the Advantage software package, and the peaks were  
3 fitted using smart baseline subtraction.

#### 4 *2.2 Electrochemical characterisation*

5 The electrochemical characterisation was carried out in a potentiostat (Gamry  
6 Instruments, Reference 600+), employing 250 ml of SBF solution at 37 °C and pH  
7 7.40. This solution was prepared according to the ISO 23317 specification and  
8 employing analytical grade reagents NaCl (8.035 g.L<sup>-1</sup>), NaHCO<sub>3</sub> (0.355 g.L<sup>-1</sup>), KCl  
9 (0.225 g.L<sup>-1</sup>), K<sub>2</sub>HPO<sub>4</sub>.3H<sub>2</sub>O (0.231 g.L<sup>-1</sup>), MgCl<sub>2</sub>.6H<sub>2</sub>O (0.311 g.L<sup>-1</sup>), CaCl<sub>2</sub> (0.292  
10 g.L<sup>-1</sup>), Na<sub>2</sub>SO<sub>4</sub> (0.072 g.L<sup>-1</sup>) and deionised water. A standard three-electrode cell was  
11 utilised, where the working electrode was the surface of TMZF samples, where an  
12 area of 0.283 cm<sup>2</sup> was exposed. A flat platinum mesh and a Saturated Calomel  
13 Electrode (SCE, 0.242 V vs SHE, at 25 °C) were, respectively, the counter and  
14 reference electrodes. A distance of ~3 cm was invariably held between the counter  
15 and working electrodes. The SCE electrode, which was positioned near the working  
16 surface, was electrically associated in parallel to a platinum wire connected to a  
17 capacitor of 1 µF to avoid capacitive and inductive artefacts that may happen during  
18 high-frequency impedance measurements [21].

19 The experimental assembly was placed inside a Faraday box cage connected  
20 to the ground. It reduces current noise picked up by the working electrode and  
21 voltage noise caught by the reference electrode. Additionally, the electrochemical  
22 characterisations were executed in a dark environment, thus reproducing  
23 physiological conditions [22].

1 Firstly, the characterisation sequence consisted of recording the Open Circuit  
2 Potential (OCP) evolution during 1 hour of soaking into the SBF until reaching the  
3 stable state. Subsequently, electrochemical impedance spectroscopy (EIS) was  
4 performed at the OCP. The system was perturbed by a sine-wave whose amplitude  
5 was 10 mV<sub>rms</sub> vs OCP within the range of frequencies of 10<sup>-2</sup> to 10<sup>4</sup> Hz. The  
6 amplitude was large enough for both the easiness measurement of the output signal  
7 and satisfying the linearity criterion. Finally, the resistance to corrosion was  
8 assessed through potentiodynamic polarization curves recorded over the potential  
9 range of -0.03 V/SCE to +1.2 V/SCE relative to the OCP, with a scan rate of 0.3  
10 mVs<sup>-1</sup>. These corrosion tests were performed over untreated samples, CST, Nt, and  
11 NP in four different immersion periods inside the SBF solution: 0, 1, 7, and 14 days.  
12 Three samples were evaluated per condition and soaking time (different samples  
13 each time, but with the same surface treatment).

14 The program used to adjustment and simulate impedance parameters was the  
15 SIMAD® software. It was developed at the Laboratoire Interfaces et Systèmes  
16 Electrochimiques (LISE) at Pierre et Marie Curie University (UPMC) [23].

### 17 **3. Results and discussion**

18 Fig. 1 shows high-resolution SEM images of the four different surface  
19 conditions studied. Fig. 1a shows the as-polished untreated TMZF sample surface,  
20 which will be used as the reference state during the different electrochemical tests.  
21 Fig. 1b presents the sample surface after CST treatment where one may observe  
22 the etching effect on changing the initial smooth morphology to a microporous  
23 surface or coral-like structure in the submicrometric and nanometric scale. Fig. 1c



1 shows the anodised Nt samples exhibiting a network of vertically self-organised  
2 nanotubes uniformly distributed over the entire TMZF surface, and Fig. 1d shows the  
3 anodised NP surface, characterised by a nanometric and disordered worm-like  
4 structure.

5 The surface characterisation technique XPS was applied to evaluate the detail  
6 chemical bonds formed over the untreated and treated TMZF sample before the  
7 immersion periods and the electrochemical tests. High-resolution spectra were  
8 shown in Fig. 2 a–d. The standard binding energies were determined according to  
9 the standard elements from the NIST XPS database [24]. The untreated sample  
10 displayed strong Ti-2p, Mo-3d, Zr-3d, and O-1s peaks. The Ti-2p spectrum (Fig. 2a)  
11 can be fitted into  $Ti^{4+}$  (458.48 eV and 464.28 eV),  $Ti^{3+}$  (458.08 eV and 463.28 eV),  
12 and  $Ti^0$  (454.22 eV and 460.62 eV), which corresponded to  $TiO_2$ ,  $Ti_2O_3$  and metallic  
13 titanium, respectively. Similarly, the Mo-3d spectrum was fitted into  $Mo^{+4}$  (229.57 eV  
14 and 232.90 eV) and  $Mo^{+6}$  (231.93 eV and 235.27 eV) corresponding to  $MoO_2$  and  
15  $MoO_3$ , respectively. The O-1s spectrum can be divided into three peaks,  $O^{2-}$   
16 (529.90 eV), the peak relates to -OH (530.57 eV), and the oxygen bound in the  
17 absorbed  $H_2O$  (532.23 eV). The Zr-3d spectrum was fitted into  $Zr^{4+}$  (182.13 eV and  
18 184.51 eV), referring to  $ZrO_2$ . Similar analyses were conducted over CST samples  
19 (Fig. 2b); in this surface condition was not observed the  $Ti^0$  peaks, due to the  
20 formation of the sodium titanate layer on the sample surface, as observed in Fig. 1b.  
21 As shown in the Na-1s spectrum from Fig. 2b, the binding energy at 1071.53 eV is  
22 characteristic for Na-1s and assigned to the Na–O bond of sodium titanates [25].  
23 Distinctive peaks from molybdenum oxides were not observed in the CST samples,

1 and the peaks related to zirconium oxides showed low intensity. Both anodised  
2 conditions, Nt, and NP show similar spectra (Fig. 2c and 2d, respectively); here, the  
3 high-resolution spectra of Ti-2p show as expected only the contribution of the Ti-  
4 2p<sub>3/2</sub> and Ti-2p<sub>1/2</sub>, characteristic for Ti<sup>4+</sup> state of TiO<sub>2</sub> [26]. The Mo-3d spectra from  
5 Fig 2c and 2d show the presence of the MoO<sub>3</sub> and a non-stoichiometric oxide MoO<sub>x</sub>  
6 [27], indicating that the anodisation process promotes the transformation of the  
7 naturally formed MoO<sub>2</sub> to the MoO<sub>3</sub> and MoO<sub>x</sub> [28].

8 The XPS spectra (Fig. 2) show the chemical differences among the different  
9 surface condition. On the untreated samples was detected the presence of TiO<sub>2</sub>,  
10 Ti<sub>2</sub>O<sub>3</sub> and metallic titanium. As expected, the CST surface is mainly composed of  
11 sodium titanate. Furthermore, the anodisation process and the subsequent thermal  
12 treatment favoured the surface transformation to more stable titanium oxide (TiO<sub>2</sub>).  
13 We calculated the Ti/Mo oxides ratio and observed an increase from the value of the  
14 untreated condition (0.07) to 0.39 for Nt and 0.32 for NP. These surface  
15 characteristics help to create a more corrosion resistant surface [29], as observed in  
16 Fig. 9.

17 Fig. 3 compares the typical potentiodynamic polarization curves of a  
18 representative sample for each surface condition and immersion time. From these  
19 curves, it was calculated the corrosion potential ( $E_{corr}$ ) corresponding to the position  
20 where the net current is zero and is indicated as the "peak" directed downwards on  
21 the polarization curves.

22 The inherent features of the polarization curves indicated a stable passive  
23 behaviour for all surface conditions and immersion periods. However, after 0 days,

1 samples covered by nanotubes produced curves with fluctuations in the passive  
2 domain because of the creation of a localised aggressive environment that breaks  
3 the passivation layer [11]. These kinds of oscillations can be attributed to the  
4 competition between the passive-film establishment and dissolution. Remained  
5 fluoride ions trapped into the tubes from the anodisation process could enhance this  
6 phenomenon [30].

7 The values of  $E_{corr}$  for the four different surface treatments are summarised in  
8 Fig. 4. Such open circuit potential values are comparable to those obtained for each  
9 condition after immersion for one hour. Initially, untreated samples show a low  
10 corrosion potential close to  $-0.370 V_{SCE}$ . However, this value increases considerably  
11 after one day of immersion and remains almost constant at  $-0.050 V_{SCE}$  until 14 days  
12 in the SBF solution.

13 Furthermore, CST, Nt, and NP samples showed a nobler behaviour ( $-0.190$ ,  $-$   
14  $0.072$ , and  $-0.115 V_{SCE}$ , respectively) compared to untreated samples without  
15 previous immersion (0D). This behaviour was less pronounced for samples treated  
16 with HCl plus NaOH, indicating a lower corrosion resistance than samples after  
17 anodisation (Fig. 4). After soaking in SBF for one day, all of them tended to higher  
18 potential values close to  $-0.050 V_{SCE}$ .

19 As part of this study, rather than corrosion current density ( $i_{corr}$ ), the current  
20 density of the passivation plateau ( $i_{pass}$ ) was chosen to establish a better comparison  
21 between the different surfaces obtained, which are likely to passivation. However, in  
22 some passivated materials exposed to physiological environments, the current  
23 density is not independent of the potential in the passive state. One reason is the

1 dynamic character of the test, i.e., the changes of the passive film with the applied  
2 potential are prolonged to remain stable with the scan. Another possibility may be  
3 that changes in the passive layer are uncompensated for the increased oxidative  
4 driving force during the measurement [11].

5 In practice, the shapes of branches anodic are not identical for all the samples  
6 (Fig. 3), and the determination of  $i_{pass}$  may not be straightforward. Thus, the sample  
7  $i_{pass}$  was obtained from the average of current densities measured in the potential  
8 range of +0.4 V<sub>SCE</sub> and +1 V<sub>SCE</sub> relative to the OCP [7].

9 Fig. 5 presents values of  $i_{pass}$  and the category of the resistance to corrosion of  
10 the different surface treatments in different immersion times. Untreated specimens  
11 show moderate-to-low and long-lasting results with  $i_{pass}$  closer to 2.0  $\mu\text{A}\cdot\text{cm}^{-2}$  during  
12 the different periods analysed, because of the existence of a homogenous and thin  
13 passive layer on the alloy surface.

14 From an electrochemical standpoint, samples with CST showed the lower  
15 corrosion resistance among the four systems for the various immersion times,  
16 showing  $i_{pass}$  values higher than 12  $\mu\text{A}\cdot\text{cm}^{-2}$  for 0, 1, and 7 days soaking in SBF.  
17 However, after 14 days, it was possible to see a reduction in its  $i_{pass}$  value ( $\sim 8.0$   
18  $\mu\text{A}\cdot\text{cm}^{-2}$ ). This chemical treatment produces micro, submicron, and nanometre  
19 features on the titanium sample. These fine network structures are favourable to  
20 accelerate hydroxyapatite nucleation because of the development of a sponge-like  
21 structure. However, this structure facilitates the diffusion and charge transfer amid  
22 electrolyte and the TMZF substrate [31].

1 Initially, for 0 and 1 day of immersion, Nt samples showed high  $i_{pass}$  values of  
2 around  $5.0 \mu\text{A}\cdot\text{cm}^{-2}$ . Nonetheless, after 7 and 14 days, the  $i_{pass}$  values were lower  
3 than  $0.8 \mu\text{A}\cdot\text{cm}^{-2}$ . In the beginning, ordered nanotubes offered free paths for ion  
4 diffusion between the electrode and the bulk electrolyte. After a few immersion days,  
5 these channels began to close by the deposition of calcium phosphate on the outer  
6 and bottom nanotubes parts, with additional growth of the inner passive film [32],  
7 which could have hindered the transfer of ions through such channels.

8 NP samples exhibited good electrochemical behaviour with low and stable  $i_{pass}$   
9 values during all immersion periods, exhibiting  $i_{pass}$  values smaller than  $0.3 \mu\text{A}\cdot\text{cm}^{-2}$   
10 after 14 days soaked in SBF. This performance was correlated with the  
11 homogeneous passive layer formed on the TMZF surface, which is thicker than the  
12 passive layer of the untreated samples.

13 Additional electrochemical information is obtained from EIS measurements and  
14 respective data elucidation. Fig. 6 presents the evolution of Nyquist plots and Bode  
15 diagrams with immersion times in SBF of untreated TMZF samples (polished  
16 surfaces); replicate specimens showed similar results but were not plotted for better  
17 visualization of the diagrams (reproducibility was checked). Bode representations  
18 were rectified for the ohmic resistance (resistance of the electrolyte ( $R_e$ )), roughly  
19 calculated between  $20\text{-}30 \Omega\cdot\text{cm}^2$ , which was deduced from the frequency of  
20  $f = 10^4$  Hz (high-frequency limit).

21 Fig. 6a presents the Nyquist diagram for untreated samples, which reflects the  
22 typical response of a capacitive-resistive or pseudocapacitive system independent  
23 on the immersion time. It signifies that the charge transfer, and therefore the

1 reactions are limited because of the protective behaviour of the passive oxide layer  
2 [22,33].

3 The continuous increase of the impedance modulus  $|Z|$  throughout the  
4 immersion time suggests that the first two weeks in SBF enhances the resistance to  
5 corrosion of untreated samples (Fig. 6d). This observation is consistent with the  $E_{corr}$   
6 measurements (Fig. 4), which shows a significant increase from the first day of  
7 immersion and remains almost constant until 14 days.

8 Bode plot has been useful in recognising the number of time constants of a  
9 system checking the validity of an Electrical equivalent circuit (EEC). These curves  
10 are more sensitive to modelling parameters than other traditional impedance plots.  
11 Nevertheless, the presence of the ohmic resistance (electrolyte resistance) covers  
12 up the real behaviour at high frequencies. For this reason, modified Bode curves  
13 corrected from ohmic resistance are used as a reliable option when the solution  
14 resistance is not negligible [34]. Therefore, all Bode diagrams in this work were  
15 corrected from the resistance of the electrolyte using Eqs. 1 and 2.

16 The impedance modulus was corrected according to:

17 
$$|Z|_{corrected} = \sqrt{(Z_r - R_e)^2 + Z_i^2} \quad (1)$$

18 The phase angle can be obtained from:

19 
$$\Phi_{corrected} = \tan^{-1}\left(\frac{Z_i}{Z_r - R_e}\right) \quad (2)$$

20 where  $|Z|$  is the impedance modulus,  $\Phi$  the phase angle, and  $Z_r$  and  $Z_i$  the  
21 impedance real and imaginary parts, respectively.

1 Over the untreated TMZF samples, it is expected the formation of a passive bi-  
2 layer, which has been observed in similar titanium alloys containing zirconium and  
3 molybdenum [35]. This passive bi-layer would be composed of an external porous  
4 layer and an inner barrier layer; thus, it is expected to find two relaxation processes  
5 or time constants from the impedance results.

6 The main disadvantage of the corrected Bode phase plot is the need for a  
7 precise assessment of the electrolyte resistance. Inaccurate estimations could  
8 provide the wrong idea of an additional time constant at high frequencies. Besides  
9 that, the corrected curves are very susceptible to data noise at high frequencies [36].  
10 For these reasons, a complementary curve for the corrected Bode plots is the  
11 graphical description of the effective CPE exponent ( $\alpha_{\text{eff}}$ ), extracted from the  
12 impedance imaginary part ( $Z_i$ ) according to [36]:

$$\alpha_{\text{eff}}(f) = \left| \frac{d \log |Z_i(f)|}{d \log f} \right| \quad (3)$$

13  
14 Traditionally, in the curve of  $\alpha_{\text{eff}}$ , the constant phase elements (CPE) are  
15 correlated with plateaus extended during various levels of frequencies. However,  
16 these regions can decrease to form bumps or smooth peaks because of the  
17 interaction of events with close relaxation processes [36]. Therefore, Figs. 5b and c  
18 clearly show two-time constants for all samples, and thus modelled by two CPE, one  
19 of them ranging from  $10^{-2}$  Hz to  $10^2$  Hz and the second one in high frequency (around  
20  $10^4$  Hz). Thus, using the corrected-Bode phase plot and the graphical illustration of  
21 the  $\alpha_{\text{eff}}$ , it was proposed an EEC for modelling the impedance results obtained from  
22 the untreated samples (Fig. 6a).

1           In the electrical circuit of Fig. 6a,  $R_e$  denotes the SBF solution resistance. The  
2           suffix B and OP are correlated with the elements that represent the inner barrier  
3           layer and the outer porous oxide layer, respectively. Here, instead of using a pure  
4           capacitor, CPE was used because of the assumption of heterogeneous charge  
5           distribution on samples surfaces [35,37].

6           A phase element impedance is defined as  $Z_{CPE} = [Q(j\omega)^\alpha]^{-1}$ . The  $\alpha$  value is  
7           associated with the heterogeneous distribution of current as a result of the non-  
8           uniform surface. The capacitance is  $Q$ , while  $j$  and  $\omega$  are the current and frequency,  
9           respectively. The values of resistance, capacitance, and  $\alpha$  for porous and barrier  
10          layers, obtained by adjusting the experimental data using the EEC, are given in  
11          Table 1. The  $\alpha$  values close to 0.9 suggest that the behaviour of such passive layer  
12          approaches that of an ideal capacitor, immersion time-independent [37].

13          The similarity between experimental and simulated results denote that the  
14          proposed equivalent circuit fits well the experimental data. Error-values ( $X$ ) lower  
15          than 1% were found during the EIS data treatments, indicating a satisfactory fitting  
16          level (Table 1) [18].

17          The resistance values,  $R_B$ , related to inner barrier layers, increase with the  
18          immersion days and are significantly larger than the values related to outer porous  
19          layers,  $R_{OP}$ , which remain nearly constant, as Table 1 shows. These results show  
20          that the protection provided by the passive layer is predominantly because of the  
21          inner barrier layer, as also observed in other titanium alloys [35,38,39].



1 From the values of CPE (Q and  $\alpha$ ),  $R_e$ , and  $R_{OP}$ ,  $R_B$  and using the Brug equation  
2 (Eq. 4), one may obtain the effective capacitance for the passive layer, considering  
3 the titanium surface composed of an outer porous layer and a compact inner layer.

$$4 \quad C_{eff} = Q^{1/\alpha} (R_e^{-1} + R_{OP,B}^{-1})^{(\alpha-1)/\alpha} \quad (4)$$

5 The  $C_{eff}$  calculated from the values listed in Table 1 for the diverse immersion  
6 periods ranged from 18 to 9  $\mu\text{F}\cdot\text{cm}^{-2}$  for the porous layer and 12 to 3  $\mu\text{F}\cdot\text{cm}^{-2}$  for the  
7 compact inner layer, values similar to the ones observed for AISI 316L stainless steel  
8 immersed in physiological solutions [40,41]. This capacitance reduction is related to  
9 a passive layer thickness increase [18,42]. Traditionally, low capacitance values are  
10 linked with nobler electrochemical behaviour [39,42].

11 The calculation of the thickness of the compact inner layer passive film can be  
12 made using Eq. 5, which is valid for the parallel-plate capacitor model of a  
13 homogeneous oxide layer, associating the overall effective capacitance to the  
14 protective oxide layer:

$$15 \quad d_{ox} = \frac{\epsilon_r \epsilon_0}{C_{ox}} \quad (5)$$

16 Where  $\epsilon_0$  is the vacuum permittivity ( $8.85 \times 10^{-14} \text{ F}\cdot\text{cm}^{-1}$ ), and  $\epsilon_r$  is the material  
17 relative dielectric constant (taken as  $\epsilon_r = 100$ , the dielectric constant of  $\text{TiO}_2$  [18]). By  
18 using this information, it was possible to obtain an approximation of the passive layer  
19 thickness for the diverse immersion days. The passive layer grew with the increase  
20 of the immersion days, initially, with 7 nm for non-immersed samples, to 27 nm after  
21 14 days (Fig. 7).

1 Fig. 8 presents the impedance curves for the acid and alkali-treated samples.  
2 The impedance results in the Nyquist plots displays semicircles arc flattened at low  
3 frequencies. The radius of these arcs decreases with the increase of immersion time  
4 (Fig. 8a).

5 Figs. 8b and d show the Bode curves of CST samples soaked in SBF for  
6 different immersion times. Samples without previous immersion exhibit a  
7 progressive increase of the phase angle from high to middle frequencies, with a  
8 variation of the phase angle from  $-54^\circ$  to  $-27^\circ$ . After that, the phase achieved a  
9 minimum value of  $-74^\circ$  in the frequencies between  $10^0$  Hz –  $10^1$  Hz and remained  
10 approximately constant. This behaviour could be related to the sodium titanate layer  
11 formed on the substrate during the CST (see Table S1 in the supplementary  
12 material); this layer is considered low capacitive because of its porous nature.

13 A uniform variation in the phase angle curves is observed with the increase of  
14 immersion periods. At intermediate frequencies, a slight reduction in the phase angle  
15 was observed in samples immersed for 1 and 7 days compared to samples without  
16 previous immersion. This behaviour was related to the precipitation and growth of  
17 the first nucleus of calcium phosphate on the sample surface (Fig. 9a and Fig. S1 of  
18 the supplementary material). In the same region, after 14 days of immersion, the  
19 plateau appeared in a higher phase angle (around  $-62^\circ$ ) because of the presence of  
20 a highly dense calcium phosphate layer (Fig. 9b).

21 As it was shown in Fig. 6d, untreated samples exhibited a performance similar  
22 to a blocking electrode characterised by a slope value of -1 at all frequencies.  
23 However, irrespective of the immersion period, the CST samples behave differently

1 and show plots with slopes below one at the lower frequency region (Fig. 8d),  
2 indicating a typical behaviour of a more reactive electrode [37].

3 The effective CPE exponent ( $\alpha_{\text{eff}}$ ) plot is used to characterise better the  
4 relaxation process occurring over the surface of chemically treated samples. Fig. 8c  
5 shows similar behaviour at high and intermediated frequencies to the corrected-  
6 phase plot. Nevertheless, this plot shows an additional bump at low frequencies  
7 ( $10^{-2}$  Hz to  $10^{-1}$  Hz). This exciting behaviour was ascribed to an extra relaxation  
8 process.

9 Over the CST three relaxation processes are expected to act during the  
10 impedance test, one above the two found in the untreated samples, which is related  
11 to the external sodium titanate layer created during the chemical treatment with HCl  
12 and NaOH. Fig. 8a presents the EEC, which provides a good representation for  
13 systems with a compact inner layer, an intermediate porous oxide layer, and an outer  
14 gel sodium titanate layer.

15 In the EEC (Fig. 8a),  $R_e$  represents the resistance of the electrolyte,  $R_{OP}$  and  
16  $CPE_{OP}$  represent the resistances and the capacitances of the outer porous layer,  
17 related with the dissolution of the gel sodium titanate layer and the HAp growth (see  
18 Table S1 in the supplementary information file).  $R_{IP}$  and  $R_B$  are the resistances of  
19 the intermediate porous oxide layer and the inner barrier layers, and the  $CPE_{IP}$  and  
20  $CPE_B$  are used to designate the capacitances of the outer porous layer and the  
21 compact inner layer, respectively.

22 The Nyquist plots of the EIS data of CST samples were modelled through the  
23 EEC shown in Fig. 8a. The errors measured ( $X$ ) for the experimental and simulated

1 data were lower than 1% independently of the immersion period, indicating a  
2 satisfactory fitting level. The parameters of the electrochemical impedance such as  
3 resistance, capacitance, and  $\alpha$  values, regarding the porous and barrier layers  
4 obtained from the equivalent circuit, are presented in Table 2.

5 With the increase from 0 to 7 immersion days, the  $Q_{OP}$  values decreased,  
6 showing a dissolution process of the gel sodium titanate layer. This behaviour might  
7 be related to the interaction between ions present in the physiological solution and  
8 ions in the titanate layer [32]. Between 7 and 14 days in the SBF, a mature HAp layer  
9 arose from the complete dissolution of the sodium titanate layer as can be seen in  
10 Fig. S1 of the supplemental material, which acts as a diffusion barrier corroborated  
11 by the higher  $\alpha_{OP}$  value at 14 days. This behaviour is confirmed in the Nyquist  
12 spectrum at 14 days of immersion (Fig. 8a), where it is possible to see a semicircle  
13 arc smoothed at low frequencies [32].

14 The resistance  $R_B$  decreased continuously, and concomitantly, the  $R_{OP}$   
15 increased with the immersion days, attaining a constant value between 7 and 14  
16 days. This behaviour can be linked with the continuous dissolution and formation  
17 processes of the barrier layer and the HAp layer, respectively [32].

18 Previous investigations employing Auger emission spectroscopy confirmed the  
19 presence of an oxide film between the sodium titanate layer and the titanium surface  
20 [43,44]. Through the impedance results and employing the Eq. 5 and the fitted  
21 results  $C_{effB}$  from Table 2, it is possible to calculate an approximate value of the  
22 titanium oxide inner layer thickness, whose values are summarised in Fig. 7b.

1 CST samples without immersion in SBF showed a thinner compact layer  
2 compared with the untreated samples in the same condition. During acid etching  
3 with HCl, the thin passive titanium oxide layer dissolves to form  $TiH_2$ ; immediately  
4 after, in contact with air moisture, a new titanium oxide film is developed. However,  
5 this layer is thinner than the initial one [45–47]. Similar to the untreated samples, the  
6 passive layer on the CST samples grew with the increase of the immersion days  
7 (Fig. 7b).

8 The Nyquist diagrams observation reveals that regardless of the immersion  
9 time studied, the nature of the CST impedance spectra (arcs) is typical of a reactive  
10 system. In contrast, in Fig. 10a the samples with Nt are apparently rather purely  
11 capacitive (straight line), or leastwise pseudocapacitive (inclined straight line),  
12 indicating that the faradaic reactions are very limited [37].

13 The corrected Bode phase angle plots of TMZF samples with Nt immersed in  
14 SBF are presented in Fig. 10b. At low and middle frequencies ( $10^{-2}$  Hz to  $10^1$  Hz),  
15 the phase angle remains almost constant with values approaching  $-90^\circ$ , which is the  
16 typical capacitive behaviour of a compact oxide film. The protective character of this  
17 film seemed to be enhanced with increased immersion, indicating a more protective  
18 behaviour after 14 days.

19 Fig. 11 presents Nyquist plots and the Bode diagrams evolutions with the  
20 immersion time in the SBF solution, for the TMZF samples with NP. Similarly, to Nt,  
21 NP specimens show a capacitive or pseudocapacitive behaviour, which was  
22 observed in the Nyquist diagram independently of the immersion time studied  
23 (Fig. 11a).

1           The plots of impedance modulus of TMZF samples anodised with NP showed  
2 a stable behaviour, characterised by two distinct zones (Fig. 11d). Between low and  
3 middle-frequency ( $10^{-2}$  Hz –  $10^1$  Hz), the curves exhibited a constant linear slope  
4 close -1, less inclined than the slope at higher-frequencies, around to -0.5. Similar  
5 behaviour was observed in Nt samples in Fig. 10d, which is characteristic of  
6 capacitive surfaces [30].

7           Given the information obtained through the Bode phase and the  $\alpha_{\text{eff}}$  plots  
8 (Fig. 10c and Fig. 11c), initially, both anodised conditions, Nt, and NP were fitted  
9 considering a similar electrical circuit as the one used for untreated samples (two-  
10 times constant). However, the fitting results for both anodised conditions were not  
11 satisfactory, as already mentioned in other works [18]; the adjustment errors are  
12 large, and the values of the parameters obtained are outliers.

13           An alternative model was proposed by R. De Levie and then by Bisquert to  
14 interpret the physical and chemical phenomena in porous electrodes, denominated  
15 Transmission Line Model (TLM) [48,49]. Recently titanium electrodes have been  
16 studied through impedance using TLM. These studies have shown excellent  
17 compatibility between experimental and modelling results, consistency in the  
18 parameters obtained, and a more precise interpretation of the impedance results  
19 obtained through EIS tests [19,20,22]. Thereby, a TLM was employed to simulate  
20 the impedance response of Nt and NP samples in SBF.

21           Fig.12 shows the TLM proposed in this work; employing it for modelling various  
22 microstructures and geometries regarding different hypotheses. Additionally, it is  
23 essential to stress that this model involves the volume processes distributed over

1 the whole electrode surface. Channel 1 is represented as a distributed resistance  
2 ( $R_1$ ), and the transport behaviour in channel 2 by a parallel arrangement of a  
3 resistance ( $R_2$ ) and a CPE element ( $Q_2$ ). The interfacial pseudocapacitance is  
4 represented by  $Q_3$  and the endpoints parameters by the resistance and capacitance,  
5  $R_A$ , and  $Q_B$ , respectively.

6 The TLM is composed of ten parameters that satisfactorily describe the  
7 interface behaviour (these parameters are explained in detail in the supplementary  
8 material and elsewhere [18,49,50]). The error between the experimental points and  
9 the simulation was lower than 1.0 %, independent of anodised morphology and  
10 immersion time. Only the nanotube condition after 14 days showed a higher value  
11 (1.7%), which is quite reasonable.

12 Traditionally, during the EIS measurements, the crossover frequency ( $\omega_c$ ) is  
13 higher than the highest frequency level analysed, and for this reason, the material  
14 generally behaves like a purely resistive component. However, low conductive  
15 materials show low  $\omega_c$  values [50], and thus, is then expected that in this study the  
16  $\omega_c$  be lower than the range of frequencies employed during the impedance test.  
17 Therefore, the oxide channel will display anomalous transport behaviour.

18 Table 3 shows the electrochemical impedance parameters obtained by  
19 adjusting the experimental results of Nt samples for the diverse immersion days.  
20 Additionally, the  $\omega_c$  values representing the transport mechanism through the  
21 channel 2 ( $X_2$ ) were calculated using Eq. 6.

22 
$$\omega_c = \frac{1}{r_2 q_2 (i\omega)^{1/\beta}} \quad (6)$$

1           The pseudocapacitance values  $Q_3$  varies as the immersion time increases; this  
2 could indicate the processes of formation and dissolution of small nuclei of calcium  
3 phosphates on the nanotubes' walls. Between days 7 and 14, the nucleation process  
4 is favoured, showing an evident decrease in the interface impedance. Besides, the  
5 coefficient  $b$  is close to 1, showing homogeneity and stability of the pore walls,  
6 independently of the immersion time.

7           Fig. 13 presents the behaviour of the endpoints  $Z_A$  and  $Z_B$  during the immersion  
8 days, represented by resistance and capacitance of  $R_A$  and  $Q_B$ , respectively.

9           During the immersion time in SBF, the resistance  $R_A$  gradually increases, and  
10 the  $Q_B$  decreases. This behaviour could be related to the development and growth  
11 of calcium phosphate nuclei (Initial step to the apatite formation) on the outer part of  
12 the nanotube and the bottom part of the channel. This behaviour is observed in  
13 Fig. 14 (red circles). Additionally, the  $Q_B$  decrease could be related to the growth of  
14 the inner passive film [32].

15           Table 4 shows the electrochemical impedance parameters obtained by  
16 adjusting the experimental results of NP samples for the diverse immersion days.  
17 For the Nt and NP fitting analysis, the average channel length ( $L$ ) was  $2 \times 10^{-5}$  cm.

18           For NP samples, the pseudocapacitance  $Q_3$  values are lower compared to Nt  
19 and remain almost constant regardless of the immersion time, because of the stable  
20 behaviour of the interfacial impedance ( $\zeta$ ), even in the first immersion days. Besides,  
21 the coefficient  $b$  is close to one showing homogeneity and stability of the pore walls.



1 Fig. 15 presents the endpoints parameters represented by the resistance and  
2 capacitance,  $R_A$ , and  $Q_B$ , respectively. These values were graphed to understand  
3 the behaviour of the transmission line endpoints ( $Z_A$  and  $Z_B$ ) during the immersion  
4 days of the NP samples. The values of  $R_A$  and  $Q_B$  were obtained from Table 4.

5 During the immersion time in SBF, the resistance  $R_A$  gradually increases. This  
6 behaviour could be ascribed to possible nucleation and growth of hydrated silica gel  
7 and amorphous calcium phosphate on the outer and inner parts of the nanopores,  
8 both predecessors for the apatite formation [51] (see Fig. S1, supplemental  
9 material). This behaviour could be observed in Fig. 1 (red circles). Moreover, the  $Q_B$   
10 values were low and constant, indicating a stable and protective behaviour of the  
11 inner passive film during the entire time analysed.

12 As it was indicated, the transport behaviour in channel 2 ( $X_2$ ) is defined by a  
13 different model termed as "anomalous transport model" (a CPE,  $Q_2$ , and a  
14 resistance,  $R_2$ , parallelly connected), because the charge carrier transport  
15 mechanism is frequency-dependent (Eq. S3). For both anodising conditions, Nt, and  
16 NP,  $\omega_c$  was between 0.003 to 0.035 Hz (Eq. 6). These low values indicated a low  
17 charge transfer through the channel 2 in the frequency regime studied in this work  
18 ( $10^{-2}$  -  $10^4$  Hz).

19 Fig. 17 summarises the corrosion response after 14 days of soaking in SBF of  
20 the diverse surface conditions studied in this work; comparing the barrier resistance  
21 values ( $R_B$  for untreated and CST samples or  $R_A$  for the anodised samples) related  
22 with the resistance to corrosion obtained from the impedance data, and the  $i_{pass}$   
23 obtained from the polarization curve.

1 Untreated samples showed a good corrosion response indicated by a high  
2 resistance value and acceptable  $i_{pass}$ , lower than  $2 \mu\text{A}\cdot\text{cm}^{-2}$ . Samples treated with  
3 HCl and NaOH, contrary to untreated samples, showed a low corrosion resistance  
4 proved by the lowest  $R_B$  and the highest  $i_{pass}$  values. Finally, the anodised samples  
5 showed the best corrosion resistance corroborated by the highest and lowest values  
6 of  $R_A$  and  $i_{pass}$ , respectively.

#### 7 **4. Conclusion**

8 The electrochemical behaviour of the four different treated surface samples has  
9 been successfully studied, and the conclusions are summarised in the following  
10 paragraphs:

- 11 •  $E_{corr}$  values revealed that Nt and NP surfaces showed a nobler behaviour than  
12 the untreated and CST ones, indicating a more protective surface. Moreover,  
13 although these anodised surfaces showed moderate  $i_{pass}$  values in the early  
14 stages of immersion (0 and 1 day), after 14 days immersed in SBF, they  
15 showed the lowest values, close to  $0.2 \mu\text{A}\cdot\text{cm}^{-2}$ .
- 16 • Nyquist and Bode plots for the untreated TMZF samples showed a  
17 pseudocapacitive behaviour due to their very protective passive layer. The  
18 continuous increase of the impedance modulus in these samples suggested  
19 that the resistance to corrosion enhances with the immersion time.
- 20 • Through the Nyquist and Bode curves, the CST samples showed a more  
21 reactive behaviour compared with the untreated samples, independently of the  
22 immersion time in SBF. In these samples, after 14 days of immersion, it was

1 possible to observe variation in the impedance curve, which was associated  
2 with the formation of the HAp layer over the surface.

- 3 • Together with the objective of forming a thicker and denser oxide layer by the  
4 anodizing process, the increased presence of TiO<sub>2</sub> and molybdenum oxides  
5 helped create a more protective surface against corrosion.
- 6 • Impedance curves of the anodised samples in SBF revealed a capacitive or at  
7 least pseudocapacitive behaviour, corroborating the protective response of  
8 these surface conditions. Additionally, it was observed a particular behaviour  
9 that could not be modelled by the traditional equivalent circuits. Thus, it was  
10 proposed a two-channel transmission line model for analysing the impedance  
11 results successfully.

## 12 **Acknowledgements**

13 The authors are grateful to the French Committee for the Evaluation of  
14 Academic and Scientific Cooperation with Brazil (COFECUB) and the Brazilian  
15 Coordenação de Aperfeiçoamento de Pessoal de Nível Superior - Brazil (CAPES)  
16 for funding the bilateral cooperation under the grant #88887.137755/2017-00. This  
17 study was financed in part by the Coordenação de Aperfeiçoamento de Pessoal de  
18 Nível Superior – Brasil (CAPES) – Finance Code 001. CAEC and LCC thanks CNPq  
19 (Brazil) under the grant #141952/2019-9 and #150782/2019-5. The authors  
20 acknowledge CNPq (Brazil) under the grants universal project #403955/2016-5 and  
21 409847/2016-0. AMJJ would like to acknowledge the CNPq (Brazil) under grant  
22 #301429/2017-0.

23

## 1 **Data availability**

2 The raw/processed data that required to reproduce these findings cannot be shared  
3 at this time due to technical or time limitations.

## 4 **References**

- 5 [1] S. Minagar, C.C. Berndt, J. Wang, E. Ivanova, C. Wen, A review of the  
6 application of anodization for the fabrication of nanotubes on metal implant  
7 surfaces, *Acta Biomater.* 8 (2012) 2875–2888.  
8 <https://doi.org/10.1016/j.actbio.2012.04.005>.
- 9 [2] C.N. Elias, J.H.C. Lima, R. Valiev, M.A. Meyers, Biomedical applications of  
10 titanium and its alloys, *J. Miner. Met. Mater. Soc.* 60 (2008) 46–49.  
11 <https://doi.org/10.1007/s11837-008-0031-1>.
- 12 [3] Australian Orthopaedic Association National Joint Replacement Registry  
13 (AOANJRR). Hip, knee & shoulder arthroplasty - Annual Report 2018,  
14 Adelaide AOA, 2018. (2018) 1–444. [www.aoa.org.au](http://www.aoa.org.au).
- 15 [4] A. Ito, Y. Okazaki, T. Tateishi, Y. Ito, In vitro biocompatibility, mechanical  
16 properties, and corrosion resistance of Ti-Zr-Nb-Ta-Pd and Ti-Sn-Nb-Ta-Pd  
17 alloys, *J. Biomed. Mater. Res.* 29 (1995) 893–900.
- 18 [5] ASTM F1813-13, Standard Specification for Wrought Titanium-  
19 12Molybdenum-6Zirconium-2Iron Alloy for Surgical Implant, ASTM Int. (2013)  
20 1–5. <https://doi.org/10.1520/F1813-13.2>.
- 21 [6] C.A.E. Claros, D.P. de Oliveira, Fatigue behavior of Ti–6Al–4V alloy in saline  
22 solution with the surface modified at a micro- and nanoscale by chemical

- 1 treatment, *Mater. Sci. Eng. C.* 67 (2016) 425–432.  
2 <https://doi.org/10.1016/j.msec.2016.04.099>.
- 3 [7] F. Hilario, V. Roche, R.P. Nogueira, A.M.J. Junior, Influence of morphology  
4 and crystalline structure of TiO<sub>2</sub> nanotubes on their electrochemical properties  
5 and apatite-forming ability, *Electrochim. Acta.* 245 (2017) 337–349.  
6 <https://doi.org/10.1016/j.electacta.2017.05.160>.
- 7 [8] Y. Wang, C. Wen, P. Hodgson, Y. Li, Biocompatibility of TiO<sub>2</sub> nanotubes with  
8 different topographies, *J. Biomed. Mater. Res. - Part A.* 102 (2014) 743–751.  
9 <https://doi.org/10.1002/jbm.a.34738>.
- 10 [9] S. Minagar, C.C. Berndt, J. Wang, E. Ivanova, C. Wen, A review of the  
11 application of anodization for the fabrication of nanotubes on metal implant  
12 surfaces, *Acta Biomater.* 8 (2012) 2875–2888.  
13 <https://doi.org/10.1016/j.actbio.2012.04.005>.
- 14 [10] N.K. Awad, S.L. Edwards, Y.S. Morsi, A review of TiO<sub>2</sub> NTs on Ti metal:  
15 Electrochemical synthesis, functionalization and potential use as bone  
16 implants, *Mater. Sci. Eng. C.* 76 (2017) 1401–1412.  
17 <https://doi.org/10.1016/j.msec.2017.02.150>.
- 18 [11] R.J. Narayan, *ASM Handbook, Volume 23 Materials for Medical Devices*, 1 st,  
19 2012.
- 20 [12] S. Noubissi, A. Scarano, S. Gupta, A literature review study on atomic ions  
21 dissolution of titanium and its alloys in implant dentistry, *Materials (Basel)*. 12  
22 (2019) 1–15. <https://doi.org/10.3390/ma12030368>.

- 1 [13] D.M. Gordin, R. Ion, C. Vasilescu, S.I. Drob, A. Cimpean, T. Gloriant,  
2 Potentiality of the “gum Metal” titanium-based alloy for biomedical  
3 applications, *Mater. Sci. Eng. C.* 44 (2014) 362–370.  
4 <https://doi.org/10.1016/j.msec.2014.08.003>.
- 5 [14] M.F. Ijaz, C. Vasilescu, S.I. Drob, P. Osiceanu, M. Marcu, H.Y. Kim, S.  
6 Miyazaki, D.M. Gordin, T. Gloriant, Electrochemical characterization of the  
7 superelastic (Ti-Zr)-Mo-Sn biomedical alloy displaying a large recovery strain,  
8 *Mater. Corros.* 68 (2017) 1220–1227.  
9 <https://doi.org/10.1002/maco.201709484>.
- 10 [15] E. Vasilescu, P. Drob, D. Raducanu, I. Cinca, D. Mareci, J.M. Calderon  
11 Moreno, M. Popa, C. Vasilescu, J.C. Mirza Rosca, Effect of thermo-  
12 mechanical processing on the corrosion resistance of Ti6Al4V alloys in  
13 biofluids, *Corros. Sci.* 51 (2009) 2885–2896.  
14 <https://doi.org/10.1016/j.corsci.2009.08.014>.
- 15 [16] M.L.D.C.R.D.A. Carvalho, Corrosion of copper alloys in natural seawater –  
16 Effects of hydrodynamics and pH, Université Pierre et Marie Curie, 2014.
- 17 [17] M. Itagaki, S. Suzuki, I. Shitanda, K. Watanabe, H. Nakazawa, Impedance  
18 analysis on electric double layer capacitor with transmission line model, *J.*  
19 *Power Sources.* 164 (2007) 415–424.  
20 <https://doi.org/10.1016/j.jpowsour.2006.09.077>.
- 21 [18] F. Hilario, V. Roche, A.M. Jorge, R.P. Nogueira, Application of the  
22 transmission line model for porous electrodes to analyse the impedance

- 1 response of TiO<sub>2</sub> nanotubes in physiological environment, *Electrochim. Acta.*  
2 253 (2017) 599–608. <https://doi.org/10.1016/j.electacta.2017.09.045>.
- 3 [19] C. Martínez, C. Guerra, D. Silva, M. Cubillos, F. Briones, L. Muñoz, M.A. Páez,  
4 C. Aguilar, M. Sancy, Effect of porosity on mechanical and electrochemical  
5 properties of Ti–6Al–4V alloy, *Electrochim. Acta.* 338 (2020) 2–11.  
6 <https://doi.org/10.1016/j.electacta.2020.135858>.
- 7 [20] C. Guerra, M. Sancy, M. Walczak, D. Silva, C. Martínez, B. Tribollet, C.  
8 Aguilar, Evolution of oxide film on the internal porosity of Ti-30Nb-13Ta-2Mn  
9 alloy foam, *Electrochim. Acta.* 283 (2018) 676–682.  
10 <https://doi.org/10.1016/j.electacta.2018.05.010>.
- 11 [21] S. Fletcher\*, The two-terminal equivalent network of a three-terminal  
12 electrochemical cell, *Electrochim. Acta.* 55 (2010) 1907–1911.  
13 <https://doi.org/10.1016/j.electacta.2009.11.008>.
- 14 [22] F. HILARIO, Synthèse et caractérisations de nanotubes de TiO<sub>2</sub> pour  
15 applications biomédicales : propriétés électrochimiques et bioactivité,  
16 Université Grenoble Alpes, 2018.
- 17 [23] B.E. Torres Bautista, M.L. Carvalho, A. Seyeux, S. Zanna, P. Cristiani, B.  
18 Tribollet, P. Marcus, I. Frateur, Effect of protein adsorption on the corrosion  
19 behavior of 70Cu-30Ni alloy in artificial seawater, *Bioelectrochemistry.* 97  
20 (2014) 34–42. <https://doi.org/10.1016/j.bioelechem.2013.10.004>.
- 21 [24] NIST X-ray Photoelectron Spectroscopy Database, NIST Standard Reference  
22 Database Number 20, National Institute of Standards and Technology,

- 1 Gaithersburg MD, 20899 (2000), (n.d.). <https://doi.org/10.18434/T4T88K>.
- 2 [25] L.L. Marciniuk, P. Hammer, H.O. Pastore, U. Schuchardt, D. Cardoso, Sodium  
3 titanate as basic catalyst in transesterification reactions, *Fuel*. 118 (2014) 48–  
4 54. <https://doi.org/10.1016/j.fuel.2013.10.036>.
- 5 [26] J.E. Berger, A.M. Jorge Jr, G.H. Asato, V. Roche, Formation of self-ordered  
6 oxide nanotubes layer on the equiatomic TiNbZrHfTa high entropy alloy and  
7 bioactivation procedure, *J. Alloys Compd.* 865 (2021) 158837.  
8 <https://doi.org/10.1016/j.jallcom.2003.09.093>.
- 9 [27] B.R. Anwar M., Hogarth C.A., se ( ICSD ) SRD 3 . For more information visit  
10 <https://ic>, *J. Mater. Sci.* 24 (1989) 3087.
- 11 [28] J.L. Xu, S.C. Tao, L.Z. Bao, J.M. Luo, Y.F. Zheng, Effects of Mo contents on  
12 the microstructure, properties and cytocompatibility of the microwave sintered  
13 porous Ti-Mo alloys, *Mater. Sci. Eng. C.* 97 (2019) 156–165.  
14 <https://doi.org/10.1016/j.msec.2018.12.028>.
- 15 [29] Y.L. Zhou, D.M. Luo, Corrosion behavior of Ti-Mo alloys cold rolled and heat  
16 treated, *J. Alloys Compd.* 509 (2011) 6267–6272.  
17 <https://doi.org/10.1016/j.jallcom.2011.03.045>.
- 18 [30] A.K. Shukla, R. Balasubramaniam, S. Bhargava, Properties of passive film  
19 formed on CP titanium, Ti-6Al-4V and Ti-13.4Al-29Nb alloys in simulated  
20 human body conditions, *Intermetallics.* 13 (2005) 631–637.  
21 <https://doi.org/10.1016/j.intermet.2004.10.001>.
- 22 [31] S.Y. Kim, Y.K. Kim, Y.S. Jang, I.S. Park, S.J. Lee, J.G. Jeon, M.H. Lee,



- 1 Bioactive effect of alkali-heat treated TiO<sub>2</sub> nanotubes by water or acid  
2 treatment, Surf. Coatings Technol. 303 (2016) 256–267.  
3 <https://doi.org/10.1016/j.surfcoat.2016.03.074>.
- 4 [32] S. Tamilselvi, V. Raman, N. Rajendran, Surface modification of titanium by  
5 chemical and thermal methods - Electrochemical impedance spectroscopic  
6 studies, Corros. Eng. Sci. Technol. 46 (2011) 585–591.  
7 <https://doi.org/10.1179/147842209X12590591256936>.
- 8 [33] V. Augustyn, P. Simon, B. Dunn, Pseudocapacitive oxide materials for high-  
9 rate electrochemical energy storage, Energy Environ. Sci. 7 (2014) 1597–  
10 1614. <https://doi.org/10.1039/c3ee44164d>.
- 11 [34] M.E. Orazem, N. Pábre, B. Tribollet, Enhanced graphical representation of  
12 electrochemical impedance data, J. Electrochem. Soc. 153 (2006) 129–136.  
13 <https://doi.org/10.1149/1.2168377>.
- 14 [35] H. Liu, J. Yang, X. Zhao, Y. Sheng, W. Li, C.L. Chang, Q. Zhang, Z. Yu, X.  
15 Wang, Microstructure, mechanical properties and corrosion behaviors of  
16 biomedical Ti-Zr-Mo-xMn alloys for dental application, Corros. Sci. 161 (2019)  
17 2–15. <https://doi.org/10.1016/j.corsci.2019.108195>.
- 18 [36] P. Córdoba-Torres, N.T.C. Oliveira, C. Bolfarini, V. Roche, R.P. Nogueira,  
19 Electrochemical impedance analysis of TiO<sub>2</sub> nanotube porous layers based on  
20 an alternative representation of impedance data, J. Electroanal. Chem. 737  
21 (2015) 54–64. <https://doi.org/10.1016/j.jelechem.2014.06.034>.
- 22 [37] Mark E. Orazem, B. Tribollett, Electrochemical Impedance Spectroscopy, in:

- 1 Agric. Food Electroanal., Second edi, 2015: pp. 381–419.  
2 <https://doi.org/10.1002/9781118684030.ch14>.
- 3 [38] S.L. De Assis, S. Wolyneć, I. Costa, Corrosion characterization of titanium  
4 alloys by electrochemical techniques, *Electrochim. Acta.* 51 (2006) 1815–  
5 1819. <https://doi.org/10.1016/j.electacta.2005.02.121>.
- 6 [39] D.Q. Martins, W.R. Osório, M.E.P. Souza, R. Caram, A. Garcia, Effects of Zr  
7 content on microstructure and corrosion resistance of Ti-30Nb-Zr casting  
8 alloys for biomedical applications, *Electrochim. Acta.* 53 (2008) 2809–2817.  
9 <https://doi.org/10.1016/j.electacta.2007.10.060>.
- 10 [40] A. Kocijan, D.K. Merl, M. Jenko, The corrosion behaviour of austenitic and  
11 duplex stainless steels in artificial saliva with the addition of fluoride, *Corros.*  
12 *Sci.* 53 (2011) 776–783. <https://doi.org/10.1016/j.corsci.2010.11.010>.
- 13 [41] K.B. Devi, K. Singh, N. Rajendran, Synthesis and characterization of  
14 nanoporous sodium-substituted hydrophilic titania ceramics coated on 316L  
15 SS for biomedical applications, *J. Coatings Technol. Res.* 8 (2011) 595–604.  
16 <https://doi.org/10.1007/s11998-011-9344-z>.
- 17 [42] S. Gudi, J. Radoševi, M. Kliški, Study of passivation of Al and Al-Sn alloys in  
18 borate buffer solutions using electrochemical impedance spectroscopy,  
19 *Electrochim. Acta.* 47 (2002) 3009–3016. [https://doi.org/10.1016/S0013-](https://doi.org/10.1016/S0013-4686(02)00246-3)  
20 [4686\(02\)00246-3](https://doi.org/10.1016/S0013-4686(02)00246-3).
- 21 [43] T. Kokubo, F. Miyaji, H.-M. Kim, T. Nakamura, Spontaneous Formation of  
22 Bonelike Apatite Layer on Chemically Treated Titanium Metals, *J. Am. Ceram.*

- 1 Soc. 79 (1996) 1127–1129. <https://doi.org/10.1111/j.1151->  
2 2916.1996.tb08561.x.
- 3 [44] H.M. Kim, F. Miyaji, T. Kokubo, T. Nakamura, Preparation of bioactive Ti and  
4 its alloys via simple chemical surface treatment., *J. Biomed. Mater. Res.* 32  
5 (1996) 409–417. [https://doi.org/10.1002/\(SICI\)1097-](https://doi.org/10.1002/(SICI)1097-)  
6 4636(199611)32:3<409::AID-JBM14>3.0.CO;2-B.
- 7 [45] L. Jonášová, F. a Müller, A. Helebrant, J. Strnad, P. Greil, Hydroxyapatite  
8 formation on alkali-treated titanium with different content of Na<sup>+</sup> in the surface  
9 layer., *Biomaterials.* 23 (2002) 3095–101.  
10 <http://www.ncbi.nlm.nih.gov/pubmed/12102180>.
- 11 [46] L. Jonášová, F. a Müller, A. Helebrant, J. Strnad, P. Greil, Biomimetic apatite  
12 formation on chemically treated titanium, *Biomaterials.* 25 (2004) 1187–1194.  
13 <https://doi.org/10.1016/j.biomaterials.2003.08.009>.
- 14 [47] S. Ban, Y. Iwaya, H. Kono, H. Sato, Surface modification of titanium by etching  
15 in concentrated sulfuric acid, *Dent. Mater.* 22 (2006) 1115–1120.  
16 <https://doi.org/10.1016/j.dental.2005.09.007>.
- 17 [48] R. de Levie, On porous electrodes in electrolyte solutions\*, *Electrochim. Acta.*  
18 9 (1964) 1231–1245. [https://doi.org/10.1016/0013-4686\(64\)85015-5](https://doi.org/10.1016/0013-4686(64)85015-5).
- 19 [49] J. Bisquert, Influence of the boundaries in the impedance of porous film  
20 electrodes, *Phys. Chem. Chem. Phys.* 2 (2000) 4185–4192.  
21 <https://doi.org/10.1039/b001708f>.
- 22 [50] G. Garcia-Belmonte, J. Bisquert, E.C. Pereira, F. Fabregat-Santiago,

1 Switching behaviour in lightly doped polymeric porous film electrodes.  
2 Improving distributed impedance models for mixed conduction conditions, J.  
3 Electroanal. Chem. 508 (2001) 48–58. <https://doi.org/10.1016/S0022->  
4 0728(01)00504-6.

5 [51] C. Shuai, H. Sun, P. Wu, C. Gao, Y. Yang, W. Guo, D. Yang, F. Xu, P. Feng,  
6 S. Peng, Biosilicate scaffolds for bone regeneration: Influence of introducing  
7 SrO, RSC Adv. 7 (2017) 21749–21757. <https://doi.org/10.1039/c7ra01606a>.

8

9

10

1

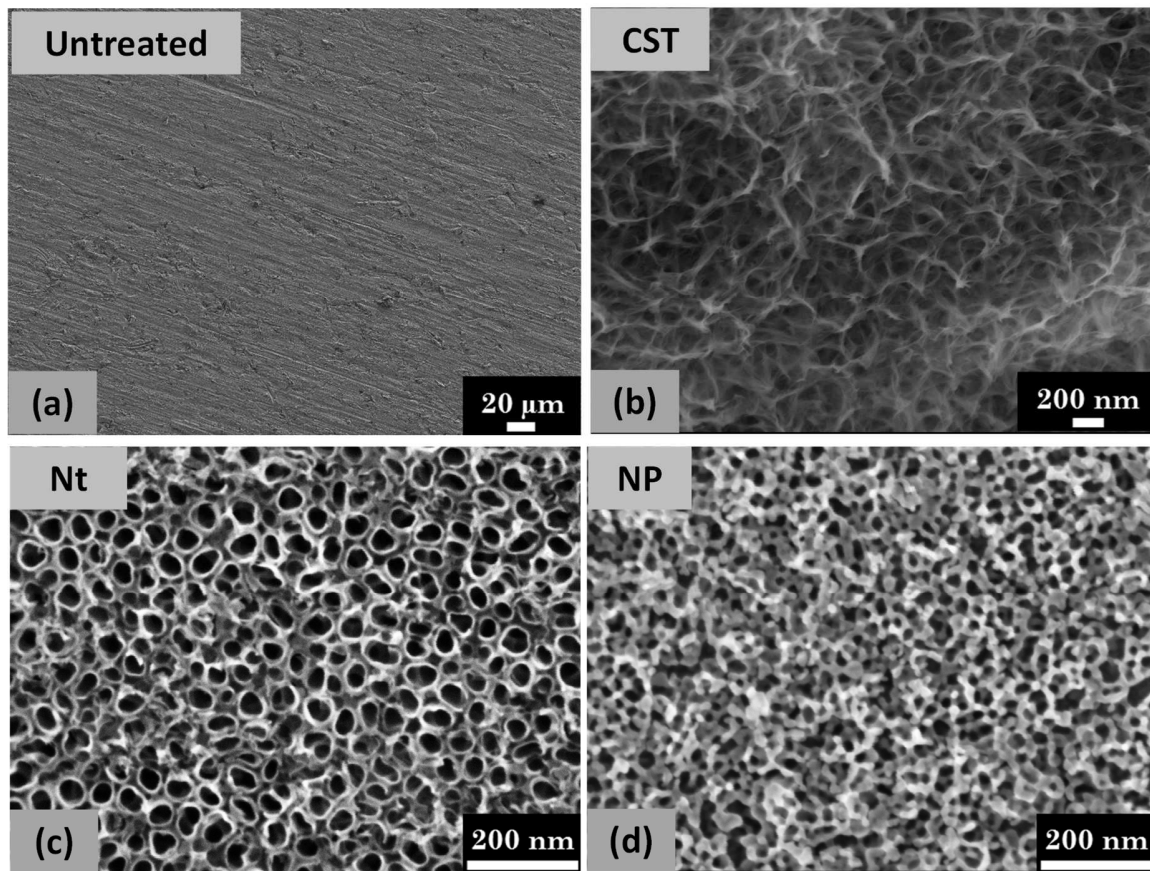

2

3 Fig. 1. SEM image of TMZF alloy: a) Untreated after polishing and grinding, b)  
4 chemically treated by HCl 37% at 60 °C and NaOH 10 mol·L<sup>-1</sup> at 60 °C for 24 h, c)  
5 and d) anodised with Nt and NP, respectively.

6

7

8

9

10

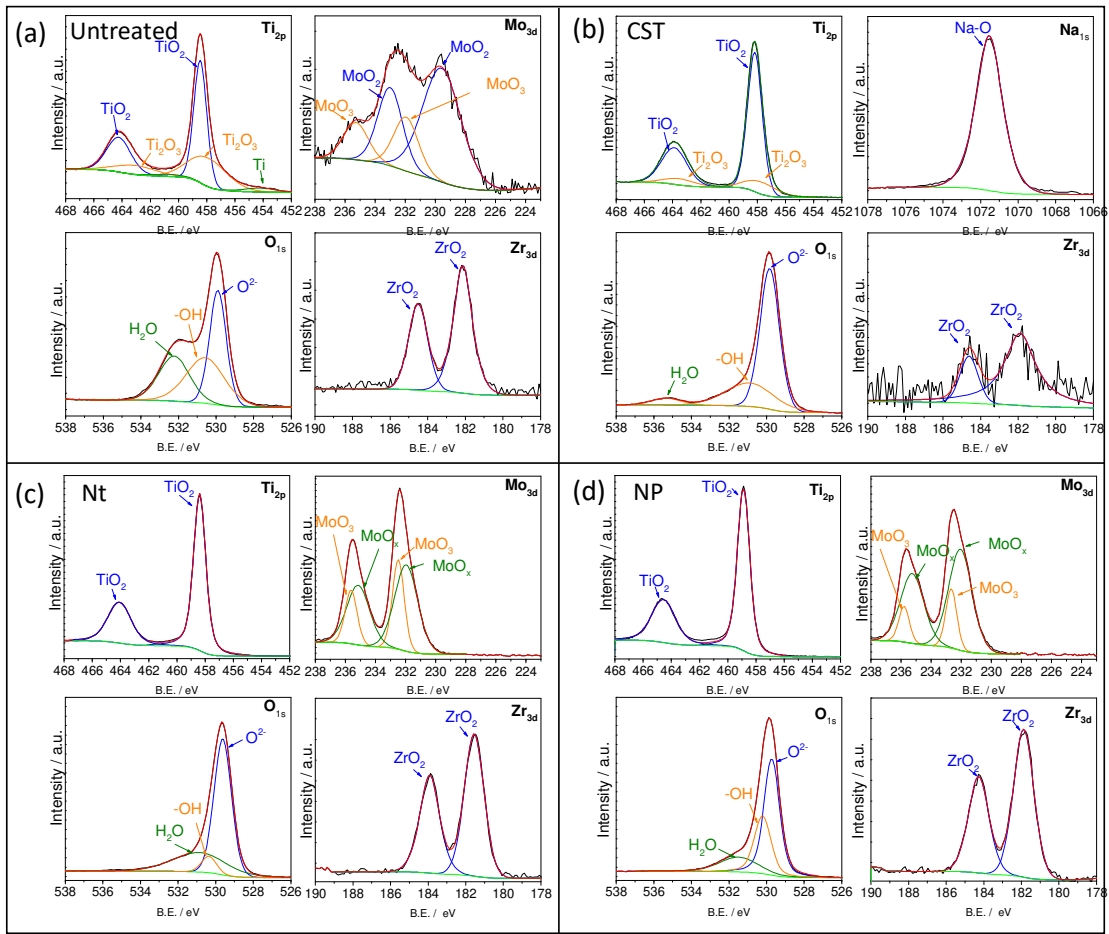

1

2 Fig. 2 High-resolution XPS spectra of Ti2p, Mo3d, O1s, Zr3d, and Na 1s obtained  
 3 for the different surface condition: a) Untreated; b) CST; c) Nt and d) NP.

4

5

6

7

8

9

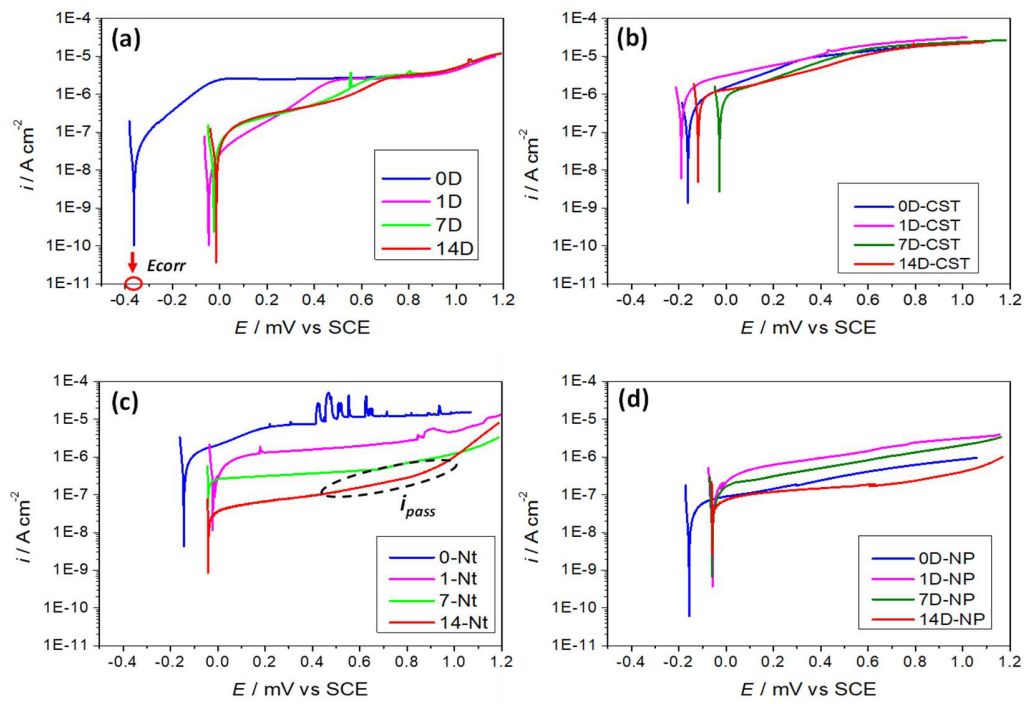

1

2 Fig. 3. Anodic polarization curves for the TMZF alloy in SBF electrolyte at 37 °C:

3 a) Untreated; b) CST; c) Nt and d) NP.

4

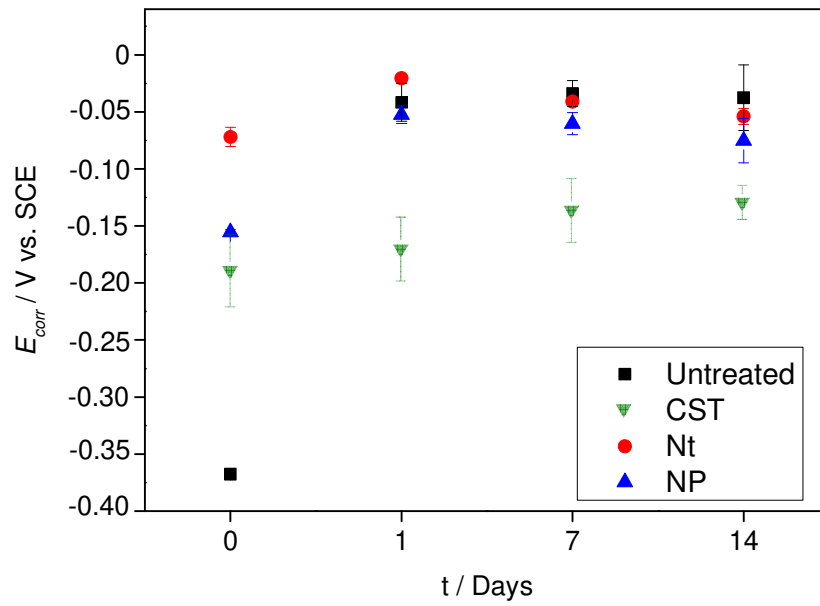

1

2 Fig. 4. Electrochemical measurements of corrosion potential ( $E_{corr}$ ) of TMZF alloy  
 3 untreated and treated with Nt, NP, and CST for different immersion times in SBF at  
 4 37°C (the error bars were obtained from the standard deviation results of three  
 5 samples per condition and soaking time).

6



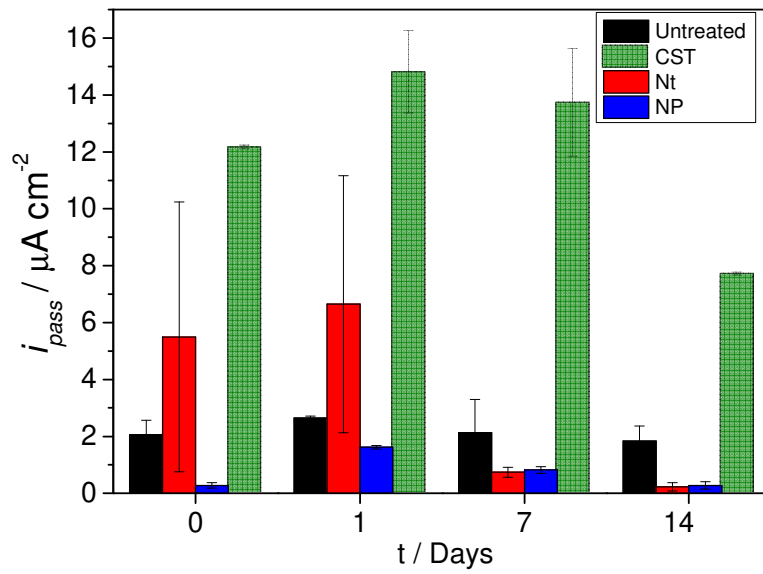

1

2 Fig 5. Electrochemical measurements of passivation current density ( $i_{pass}$ ) of TMZF  
 3 alloy untreated and treated with Nt, NP, and CST in different immersion times in SBF  
 4 at 37°C (the error bars were obtained from the standard deviation results of three  
 5 tested samples per condition and soaking time).

6

7

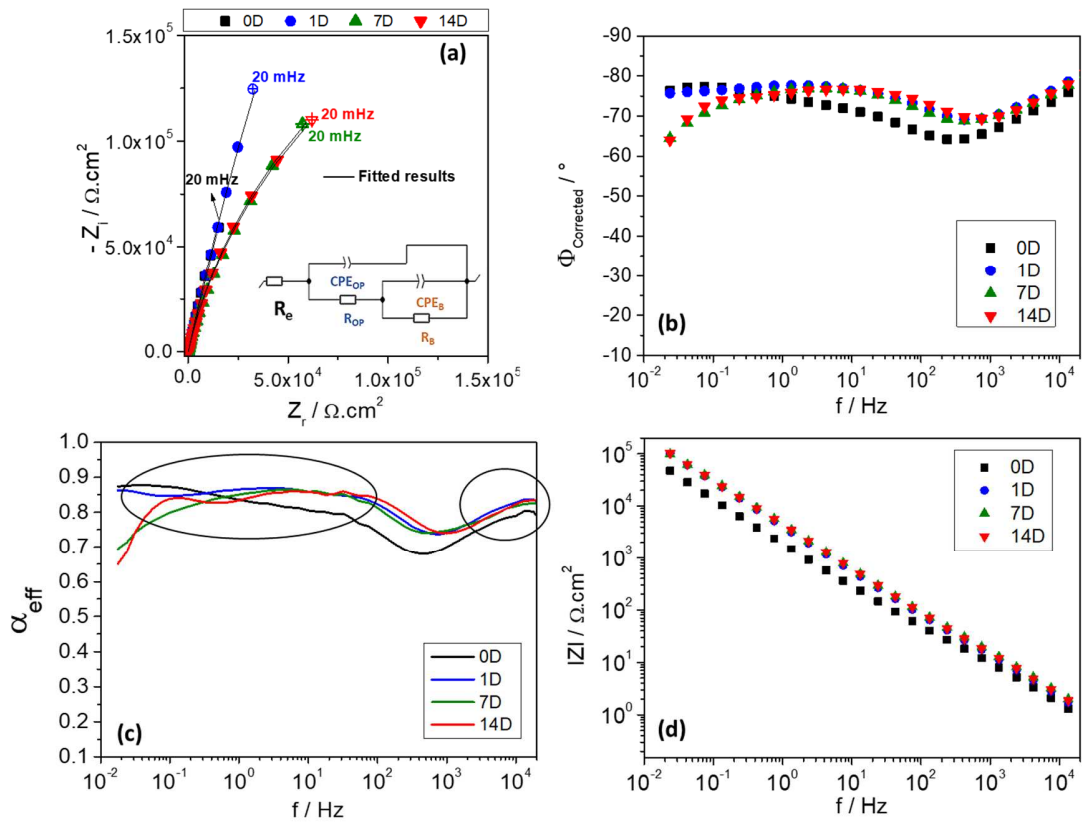

1

2 Fig. 6. Impedance results for untreated samples immersed in SBF at 37 °C for the  
 3 different immersion time (0, 1, 7, and 14 days denoted as 0D, 1D, 7D, and 14D  
 4 respectively): a) Nyquist plots of experimental and simulated results obtained using  
 5 SIMAD software and the electrical equivalent circuit employed; b) Corrected-phase  
 6 angle; c) Evolution of  $\alpha_{\text{eff}}$  versus frequency and d) Corrected-Modulus of the  
 7 impedance.

8

9

10

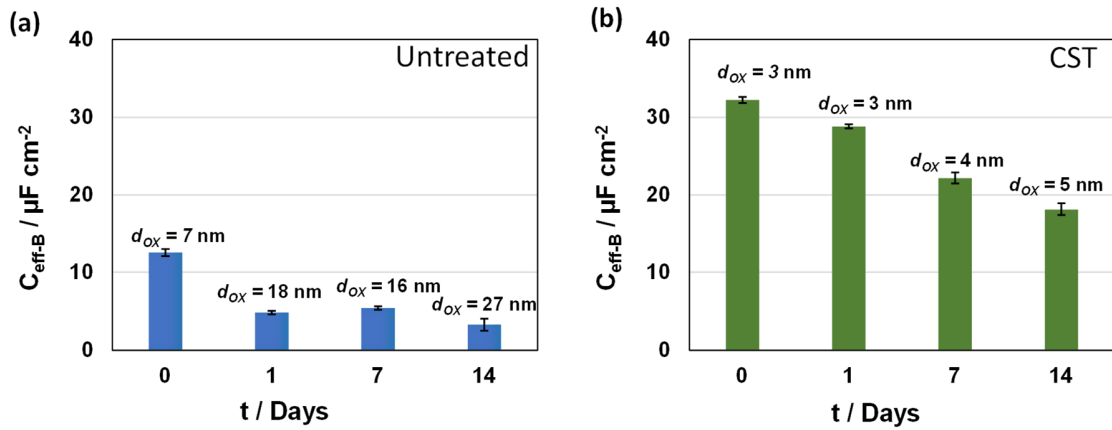

1

2 Fig. 7. Effective capacitances and thickness evolution of the passive inner layer

3 during different immersion days in SBF solution at 37 °C: a) Untreated and b) CST.

4 (these values were calculated from Tables 1 and 2).

5

6

7

8

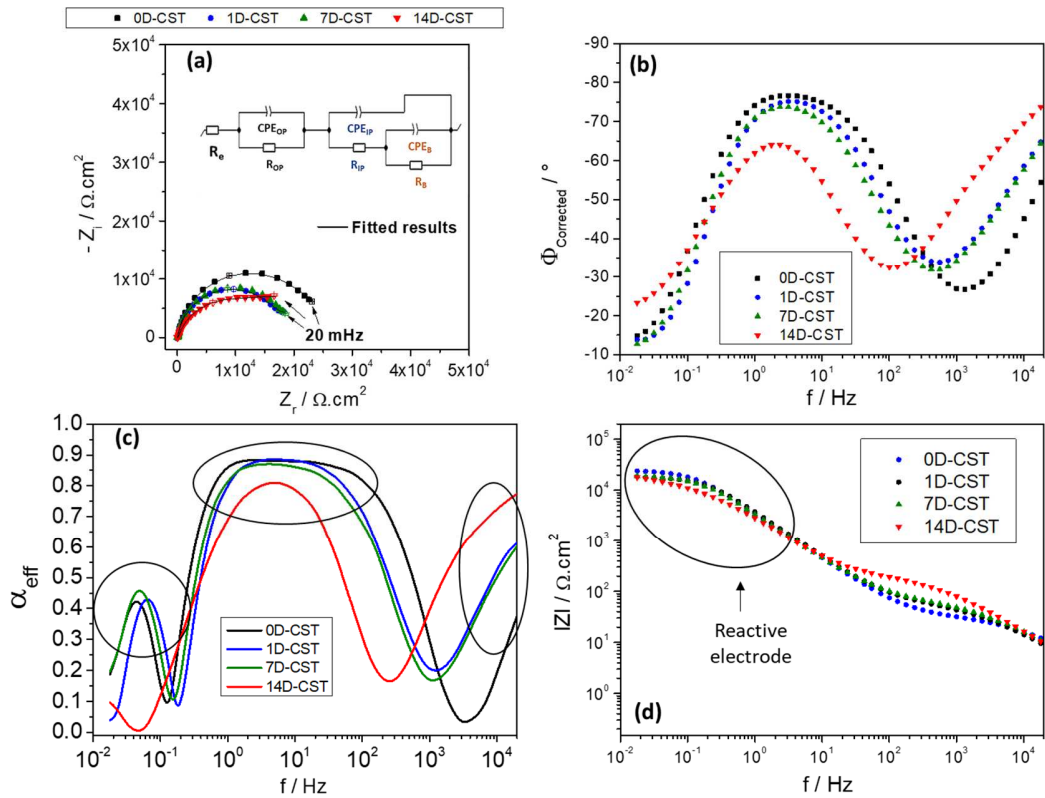

1

2 Fig. 8. Impedance results for CST samples immersed in SBF at 37 °C for the different  
 3 immersion times (0, 1, 7, and 14 days denoted as 0D, 1D, 7D, and 14D respectively):

4 a) Nyquist plots of experimental and simulated results obtained through the SIMAD  
 5 software and the electrical equivalent circuit employed; b) Corrected-phase angle;

6 c) Evolution of  $\alpha_{\text{eff}}$  versus frequency and d) Corrected-Modulus of the impedance.

7

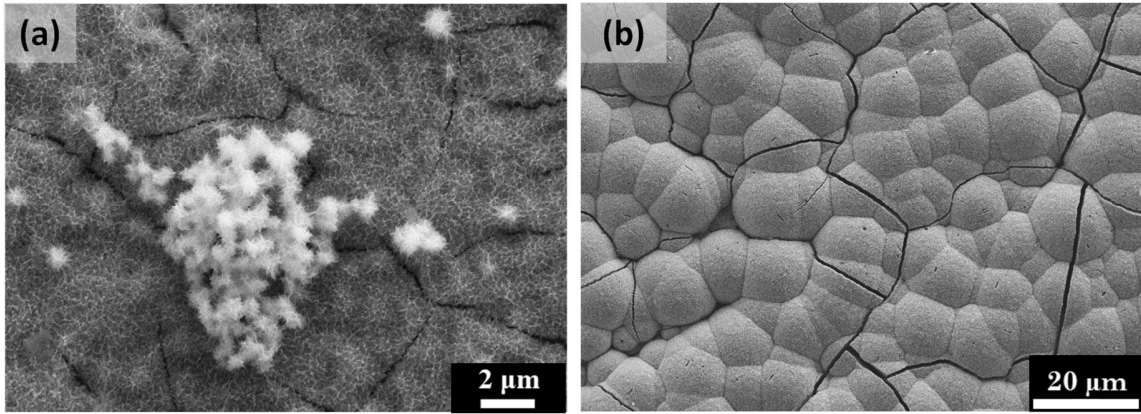

1

2 Fig. 9. SEM images for CST samples after different immersion periods in SBF:

3 a) 7 days, showing some nucleus of calcium phosphate on the sample surface, and

4 b) 14 days.

5

6

7

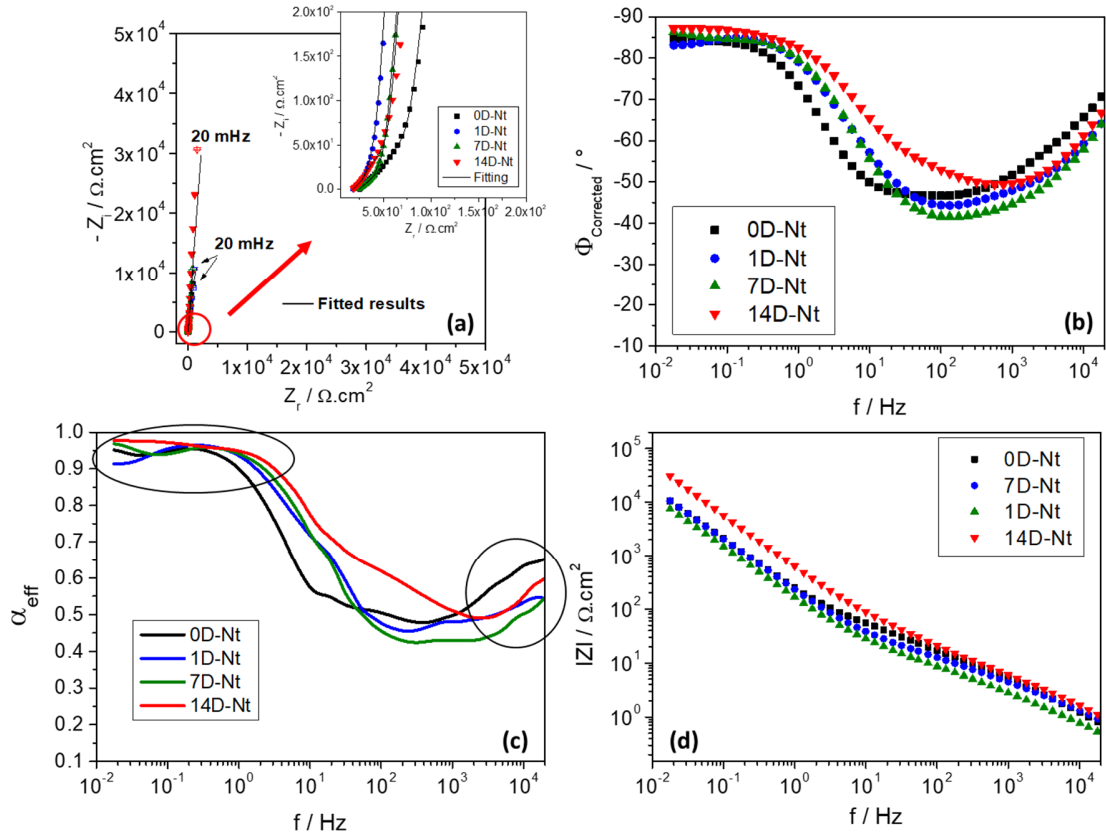

1

2 Fig. 10. Impedance results for Nt samples immersed in SBF at 37 °C for the different  
 3 immersion time (0, 1, 7, and 14 days denoted as 0D, 1D, 7D, and 14D respectively):

4 a) Nyquist plots of experimental and simulated results obtained using SIMAD  
 5 software and the electrical equivalent circuit employed; b) Corrected-phase angle;  
 6 c) Evolution of  $\alpha_{\text{eff}}$  versus frequency and d) Corrected-Modulus of the impedance.

7

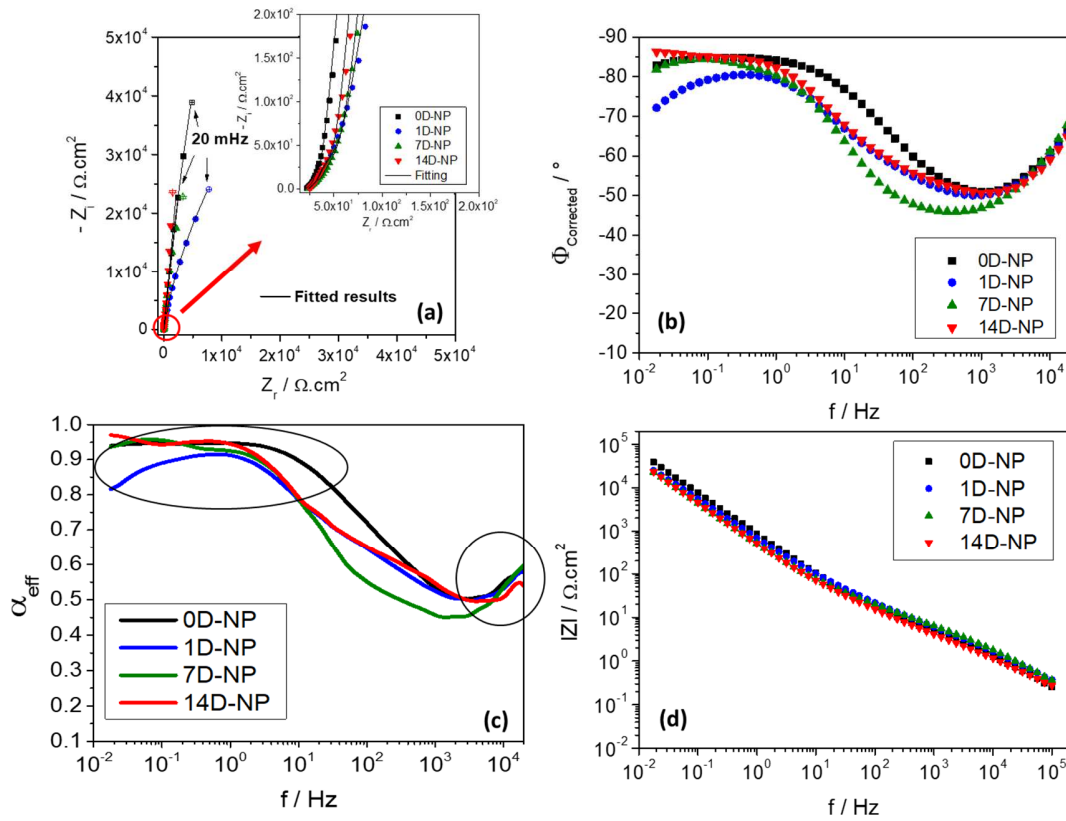

1

2 Fig. 11. Impedance results for NP samples immersed in SBF at 37 °C for the different  
 3 immersion time (0, 1, 7, and 14 days denoted as 0D, 1D, 7D, and 14D respectively):  
 4 a) Nyquist plots of experimental and simulated results obtained using SIMAD  
 5 software and the electrical equivalent circuit employed; b) Corrected-phase angle;  
 6 c) Evolution of  $\alpha_{\text{eff}}$  versus frequency and d) Corrected-Modulus of the impedance.

7

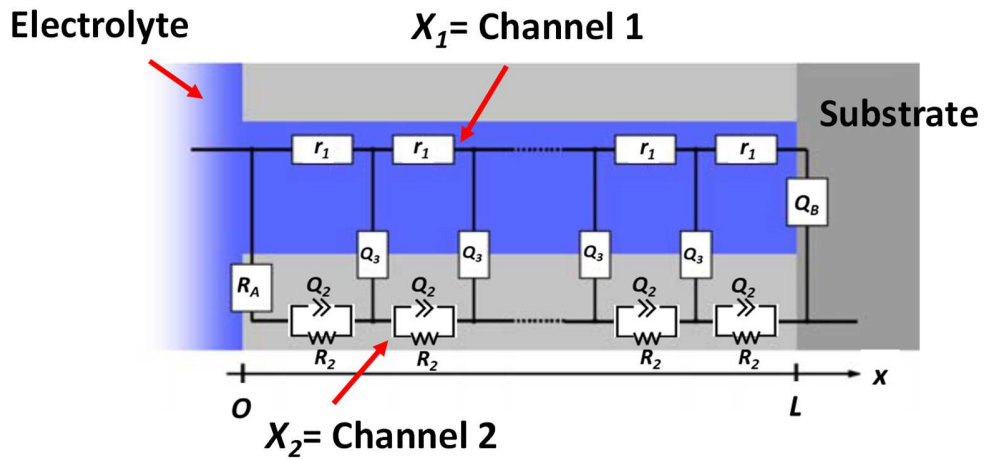

1

2 Fig. 12. The transmission line model proposed to describe the impedance response  
 3 of the anodised TMZF samples immersed in SBF at 37 °C during the different  
 4 periods evaluated.

5

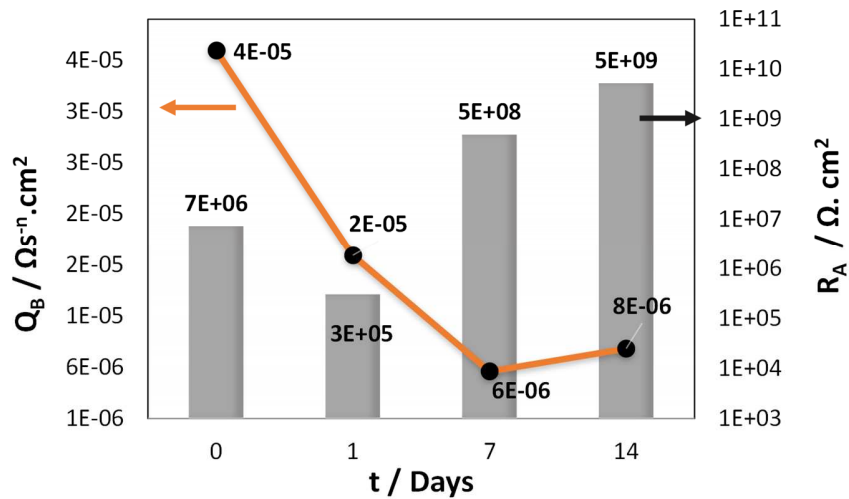

6

7 Fig. 13. Endpoints parameters,  $R_A$  and  $Q_B$ , were obtained from the transmission line  
 8 model used in nanotubes samples after different immersion periods in SBF.

9



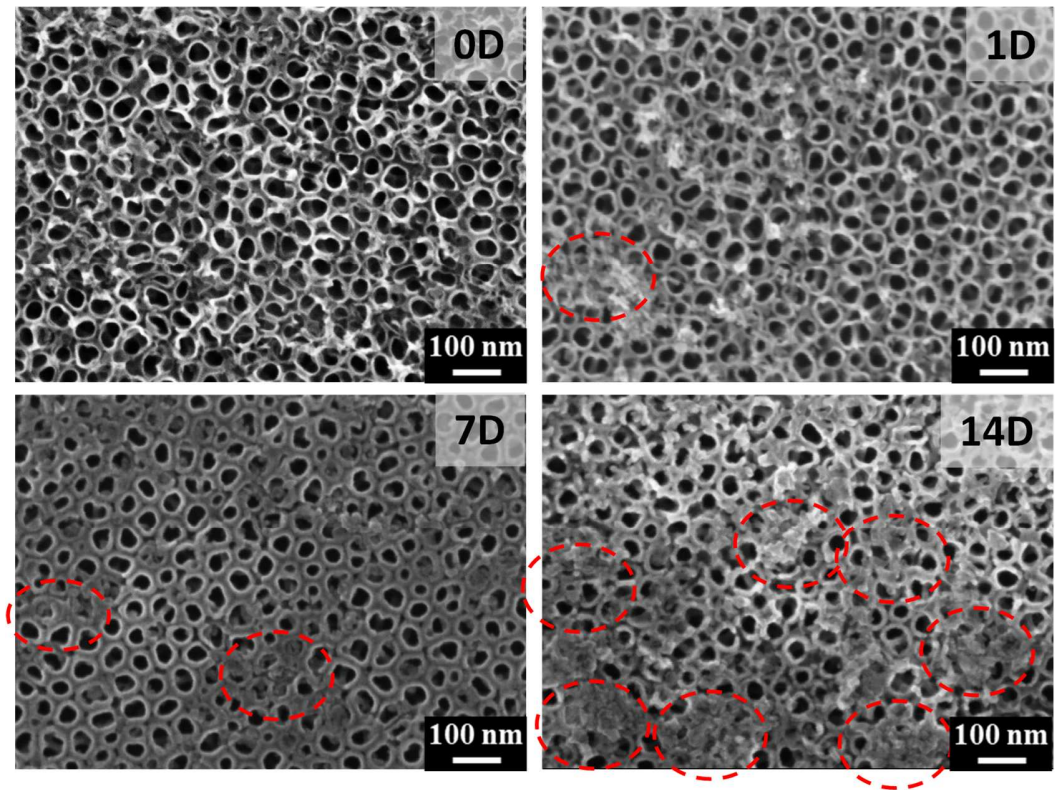

1

2 Fig. 14. Apatite formation over Nt samples after different immersion periods in SBF  
3 (0, 1, 7, and 14 days).

4

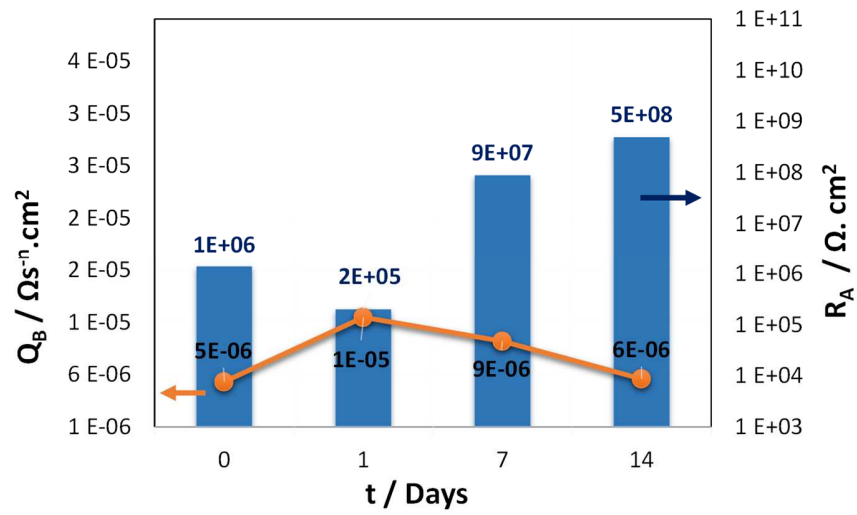

1

2 Fig. 15. Endpoints parameters,  $R_A$  and  $Q_B$ , obtained from the transmission line model  
 3 used in NP samples after different immersion periods in SBF.

4

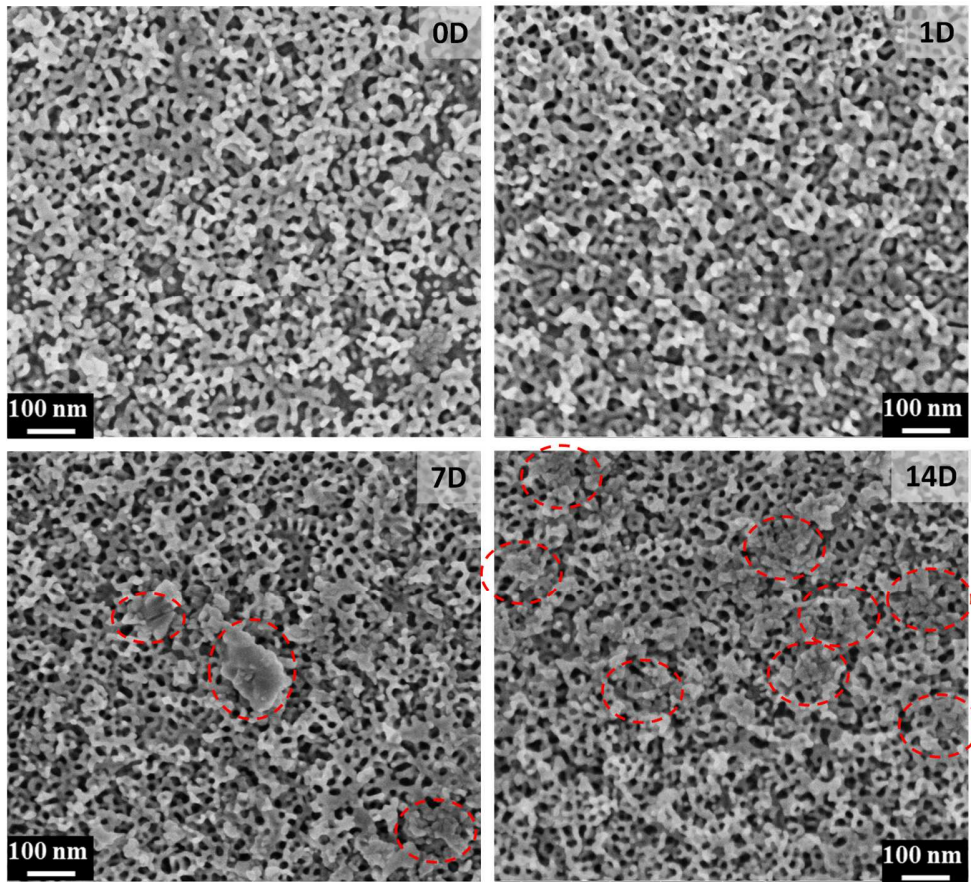

1

2 Fig. 16. Apatite formation over NP samples after different immersion periods in SBF  
3 (0, 1, 7, and 14 days).

4

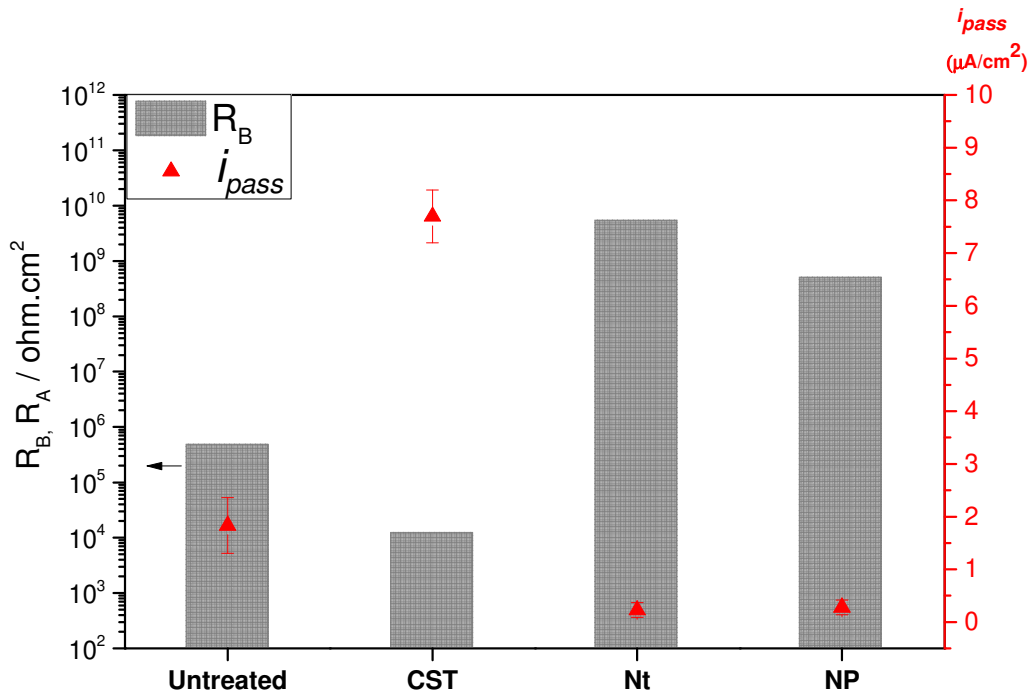

1

2 Fig. 17. Corrosion response of untreated CST, Nt, and NP samples after 14 days of  
 3 immersion in SBF at 37 °C. Barrier resistance ( $R_B$  or  $R_A$  for the anodised samples)  
 4 obtained from the impedance data, and passivation current ( $i_{pass}$ ) from the  
 5 polarization curves.

6

7

1 Table 1 Electrical parameters of the equivalent circuit obtained by fitting the  
 2 experimental results of impedance for untreated samples at 37 °C in the SBF  
 3 solution.

Immersion Days	$R_e$ ( $\Omega\text{-cm}^2$ )	$Q_{OP}$ ( $\Omega\text{s}^{-\alpha}\text{-cm}^2$ )	$\alpha_{OP}$	$R_{OP}$ ( $\Omega\text{-cm}^2$ )	$Q_B$ ( $\Omega\text{s}^{-\alpha}\text{-cm}^2$ )	$\alpha_B$	$R_B$ ( $10^5\Omega\text{-cm}^2$ )	$X$ (%)
0	23	1.74E-05	0.85	94	1.37E-05	0.83	2.83	0.45
1	20	8.35E-06	0.88	63	6.02E-06	0.84	2.90	0.23
7	21	4.80E-06	0.92	49	8.55E-06	0.81	4.64	0.22
14	20	1.04E-05	0.84	77	2.95E-06	0.88	4.60	0.77

4

5 Table 2 Electrical impedance parameters obtained by fitting the experimental results  
 6 of CST samples immersed in SBF at 37 °C for the different periods 0, 1, 7, and 14  
 7 days.

Immersion Days	$R_e$ ( $\Omega\text{-cm}^2$ )	$Q_{OP}$ ( $\Omega\text{s}^{-\alpha}\text{-cm}^2$ )	$\alpha_{OP}$	$R_{OP}$ ( $\Omega\text{-cm}^2$ )	$Q_{IP}$ ( $\Omega\text{s}^{-\alpha}\text{-cm}^2$ )	$\alpha_{IP}$	$R_{IP}$ ( $\Omega\text{-cm}^2$ )	$Q_B$ ( $\Omega\text{s}^{-\alpha}\text{-cm}^2$ )	$\alpha_B$	$R_B$ ( $\Omega\text{-cm}^2$ )	$C_{effB}$ ( $\mu\text{F}/\text{cm}^2$ )	$X$ (%)
0	25	8.61 E-04	0.57	35.05	3.31 E-06	0.71	819	1.69 E-05	0.91	48562	32	0.39
1	21	2.79 E-04	0.55	50.14	6.66 E-06	0.72	283	1.39 E-05	0.95	16366	29	0.26
7	24	3.30 E-04	0.53	112.33	9.28 E-06	0.60	283	2.46 E-05	0.84	11916	22	0.71
14	23	1.45 E-04	0.80	178.97	4.08 E-06	0.76	155	1.81 E-05	0.85	11513	18	0.82

8

9

10

11

- 1 Table 3 Electrical impedance parameters obtained by adjusting the experimental
- 2 results of Nt samples.

Days	X1		X2		$\zeta$		$Z_A$		$Z_B$		L (cm)	$\omega c$ (Hz)	X (%)
	R <sub>1</sub>	R <sub>2</sub>	Q <sub>2</sub>	e	Q <sub>3</sub>	b	R <sub>A</sub>	Q <sub>B</sub>	n				
	( $\Omega \cdot \text{cm}$ )	( $\Omega \cdot \text{cm}^2$ )	( $\Omega \text{s}^e \cdot \text{cm}^2$ )		( $\Omega \text{s}^b \cdot \text{cm}$ )		( $\Omega \cdot \text{cm}^2$ )	( $\Omega \text{s}^n \cdot \text{cm}^2$ )					
0	827	217	6.53 E-07	0.96	1.63 E-04	0.96	7.22 E+06	3.69 E-05	0.91	2.0 E-05	0.035	0.77	
1	956	222	4.55 E-07	0.76	2.96 E-04	0.96	2.99 E+05	1.69 E-05	0.84	2.0 E-05	0.023	0.48	
7	938	209	6.06 E-07	0.78	3.91 E-04	0.95	4.90 E+08	5.58 E-06	0.92	2.0 E-05	0.019	0.43	
14	860	145	2.81 E-06	0.72	9.96 E-05	0.96	5.25 E+09	7.80 E-06	0.89	2.0 E-05	0.003	1.70	

3

- 4 Table 4 Electrical impedance parameters obtained by adjusting the experimental
- 5 results of NP samples.

Days	X1		X2		$\zeta$		$Z_A$		$Z_B$		L (cm)	$\omega c$ (Hz)	X (%)
	R <sub>1</sub>	R <sub>2</sub>	Q <sub>2</sub>	e	Q <sub>3</sub>	b	R <sub>A</sub>	Q <sub>B</sub>	n				
	( $\Omega \cdot \text{cm}$ )	( $\Omega \cdot \text{cm}^2$ )	( $\Omega \text{s}^e \cdot \text{cm}^2$ )		( $\Omega \text{s}^b \cdot \text{cm}$ )		( $\Omega \cdot \text{cm}^2$ )	( $\Omega \text{s}^n \cdot \text{cm}^2$ )					
0	559	203	8.52 E-07	0.60	7.73 E-05	0.96	1.40 E+06	5.32 E-06	0.90	2.0E-05	0.003	0.60	
1	826	207	9.24 E-07	0.64	7.52 E-05	0.97	2.00 E+05	1.15.E-05	0.82	2.0E-05	0.004	0.97	
7	787	209	6.06 E-07	0.96	8.68 E-05	0.97	8.83 E+07	9.18 E-06	0.92	2.0E-05	0.004	0.43	
14	936	218	6.88 E-07	0.60	7.60 E-05	0.97	4.90 E+08	5.59 E-06	0.89	2.0E-05	0.003	1.00	

6

7