



HAL
open science

Stochastic Planning and Operational Constraint Assessment of System-Customer Power Supply Risks in Electricity Distribution Networks

Mikka Kisuule, Ignacio Hernando-Gil, Jonathan Serugunda, Jane Namaganda-Kiyimba, Mike Brian Ndawula

► **To cite this version:**

Mikka Kisuule, Ignacio Hernando-Gil, Jonathan Serugunda, Jane Namaganda-Kiyimba, Mike Brian Ndawula. Stochastic Planning and Operational Constraint Assessment of System-Customer Power Supply Risks in Electricity Distribution Networks. *Sustainability*, 2021, 13 (17), pp.9579. 10.3390/su13179579 . hal-03482370

HAL Id: hal-03482370

<https://hal.science/hal-03482370>

Submitted on 15 Dec 2021

HAL is a multi-disciplinary open access archive for the deposit and dissemination of scientific research documents, whether they are published or not. The documents may come from teaching and research institutions in France or abroad, or from public or private research centers.

L'archive ouverte pluridisciplinaire **HAL**, est destinée au dépôt et à la diffusion de documents scientifiques de niveau recherche, publiés ou non, émanant des établissements d'enseignement et de recherche français ou étrangers, des laboratoires publics ou privés.

Article

Stochastic Planning and Operational Constraint Assessment of System-Customer Power Supply Risks in Electricity Distribution Networks

Mikka Kisuule ^{1,*}, Ignacio Hernando-Gil ², Jonathan Serugunda ¹, Jane Namaganda-Kiyimba ¹ and Mike Brian Ndawula ³

¹ Department of Electrical and Computer Engineering, College of Engineering Design Art and Technology, Makerere University, Kampala P.O. Box 7062, Uganda; jonathan.serugunda@mak.ac.ug (J.S.); jane.namaganda@mak.ac.ug (J.N.-K.)

² ESTIA Institute of Technology, University of Bordeaux, 64210 Bidart, France; i.hernandogil@estia.fr

³ Centre for Sustainable Power Distribution, Department of Electronic and Electrical Engineering, University of Bath, Bath BA2 7AY, UK; m.b.ndawula@bath.ac.uk

* Correspondence: kisuule01@gmail.com

Abstract: Electricity-distribution network operators face several operational constraints in the provision of safe and reliable power given that investments for network area reinforcement must be commensurate with improvements in network reliability. This paper provides an integrated approach for assessing the impact of different operational constraints on distribution-network reliability by incorporating component lifetime models, time-varying component failure rates, as well as the monetary cost of customer interruptions in an all-inclusive probabilistic methodology that applies a time-sequential Monte Carlo simulation. A test distribution network based on the Roy Billinton test system was modelled to investigate the system performance when overloading limits are exceeded as well as when preventive maintenance is performed. Standard reliability indices measuring the frequency and duration of interruptions and the energy not supplied were complemented with a novel monetary reliability index. The comprehensive assessment includes not only average indices but also their probability distributions to adequately describe the risk of customer interruptions. Results demonstrate the effectiveness of this holistic approach, as the impacts of operational decisions are assessed from both reliability and monetary perspectives. This informs network planning decisions through optimum investments and consideration of customer outage costs.

Keywords: component lifetime models; Monte Carlo simulation; network reliability; overloading violations; preventive maintenance; risk assessment; time-varying failure rates



Citation: Kisuule, M.; Hernando-Gil, I.; Serugunda, J.; Namaganda-Kiyimba, J.; Ndawula, M.B. Stochastic Planning and Operational Constraint Assessment of System-Customer Power Supply Risks in Electricity Distribution Networks. *Sustainability* **2021**, *13*, 9579. <https://doi.org/10.3390/su13179579>

Academic Editor: Detlef Schulz

Received: 29 July 2021

Accepted: 22 August 2021

Published: 25 August 2021

Publisher's Note: MDPI stays neutral with regard to jurisdictional claims in published maps and institutional affiliations.



Copyright: © 2021 by the authors. Licensee MDPI, Basel, Switzerland. This article is an open access article distributed under the terms and conditions of the Creative Commons Attribution (CC BY) license (<https://creativecommons.org/licenses/by/4.0/>).

1. Introduction

There is increasing pressure on utilities and regulators to improve the quality of supply for customers at the lowest marginal cost. This would ensure that the level of reliability corresponds with the customer needs and expectations, i.e., if the investment required to improve the level of reliability exceeds the economic value of the service improvements the customer experiences, then the investment is unnecessary and should not be made [1]. Furthermore, any decision making in the design, planning, operation, and maintenance of power systems requires appropriate assessment tools, reliability models, and component reliability data [2].

Power-system planners and operators must balance the costs the utility will require to develop, operate, and maintain the power system against the economic value of the reliability improvement to customers to achieve socio-economically efficient investments. While network investment costs can be attained using standard engineering cost-estimation procedures [3], the economic value of reliability is measured by the customer interruption costs [4]. Optimum reliability is achieved when the additional costs for improving reliability

are proportionate to the resulting decrease in customer interruption costs. However, customer interruption costs vary widely due to the diversity of customer reliability needs and are thus not commonly considered in reliability assessments. This results in inefficient network investments because the reliability improvements do not necessarily benefit those who need them.

Methods of distribution reliability assessment have had to adapt to recent changes in distribution infrastructure, e.g., bi-directional power flow, due to significant distributed generation and deregulation of electricity markets. Emphasis has been put on assessing the reliability performance of the overall system by deriving standard reliability indices evolving from analysing the failure of individual power components (PCs). Conventional reliability analyses consider a simple constant value to characterise failure rates and have been producing valuable results for power-system planning [5], but this approach is ineffective, as a constant failure rate might underestimate the system reliability for some periods while overestimating it for others [6]. This is because failure rates vary widely depending on the ageing pattern of the PCs, their geographical location, operating characteristics, and weather conditions. Utility experience has demonstrated that failures follow a “bathtub” pattern in their lifecycle [7]. Furthermore, the expected lifetime of PCs has been assumed to be the same for all PCs in most reliability studies, e.g., [1,7–10]. However, consideration for different expected lifetimes for each PC based on historical utility data provides a more accurate representation of the failure distribution and thus a more realistic approach [11]. There is a need to model the time-varying failure rates considering the expected lifetimes of PCs to quantify the impact on distribution reliability. Such reliability models could potentially incentivise utilities to keep historical records of PC failures that can be utilised to make reliability investment decisions.

During a PC’s lifetime, the operating conditions affect its failure pattern, which in turn impacts the system reliability [7]. The reliability impact of operating the distribution network under different constraints has been the subject of many studies [3,9,12–14]. Prolonged overloading of some PC’s above-set limits significantly increases the likelihood of failure and leads to accelerated ageing [15]. However, there is a need to ascertain the extent to which distribution reliability is affected by violating these limits using established reliability-assessment techniques. Many authors have investigated the effect of different maintenance strategies on system reliability, proposing different approaches aimed at minimising the cost of maintenance while delivering the best reliability results by focusing on critical components [16–19]. To make appropriate decisions regarding maintenance, reliability modelling considering component lifetime models is required to more accurately quantify the reliability benefits from implementing different reliability-centred maintenance (RCM) approaches. This research adopts probabilistic methods [20,21] compared to analytical methods [22–24] because they express output reliability indices as probability distributions rather than simple average values and standard deviations [25]. This allows for the inclusion of uncertainties in the reliability modelling that better represent the stochastic behaviour of the distribution network [11].

To provide a link between the level of network investment required and the resulting system reliability, monetary reliability indices can be derived by accurately calculating the interruption costs using probabilistic methods derived from historical information [1]. These monetary reliability indices can enable utilities to derive the economic value attached to a given level of reliability for each customer segment when conducting power-system reliability planning to ensure economic efficiency and sustainability [3]. This research proposes the derivation of a new, cost-based index that will complement the standard reliability indices and better inform utilities’ decisions to invest more efficiently in their networks towards reliability improvement.

The contributions of this research are as follows:

- A new reliability modelling methodology that incorporates different expected lifetimes for each power component and different network operational modes;

- Use of probabilistic curve fitting to model overloading violations and maintenance actions in distribution network operation;
- A new monetary reliability index to assess the impact of different network operation modes on customer interruption costs; and
- Reliability cost-benefit analysis of operating the network under different operational constraints.

This paper is organised as follows: Section 2 provides the integrated probabilistic methodology for reliability assessment that incorporates time-varying component failure rates, different component expected lifetimes, and the cost of customer interruptions. Section 3 presents the validation and network modelling detailing the different network scenarios adopted to depict varying operational conditions. The derived reliability indices are analysed and presented in Section 4, while the conclusions and key outcomes are discussed in Section 5.

2. Risk and Reliability Modelling

The proposed methodology is based on a stochastic approach and predictive analysis that uses probabilistic variables arising from available data on outages. The reliability parameters for individual PCs can be obtained through data mining and processing of historical equipment failure records or utility outage-management systems [26]. Failure rates and mean repair times (MTTR) are the basic inputs to the reliability assessment and are modelled as probability distributions over the expected lifetime of all network PCs. A stochastic simulation is performed to derive the standard reliability indices, i.e., system average interruption duration index (SAIDI), system average interruption frequency index (SAIFI), and energy not supplied (ENS), which are expressed using their average values and probability distributions. This paper provides a comprehensive comparison between reliability modelling techniques for overloading violations and maintenance actions considering practical lifetime probabilistic models to provide a better understanding of their impact on distribution reliability.

2.1. Time-Sequential Simulation

This research adopts the Monte Carlo simulation (MCS) method [27] for stochastic simulation due to its ability to model the power-system network using known historical values and then provide the random behaviour of network PCs over a prescribed period with due consideration for the relevant input data [10]. The decision-making methodology proposed in this paper applies time-sequential MCS, which is characterised by the chronological transitions of network components from normal operation states to faulted states and vice versa depending on the input failure rates (λ) and mean repair times (μ) (expressed as probability distributions). These distributions are modelled in MATLAB by probabilistic processing of input failure rates and repair times incorporating the component lifetime models presented in Section 2.2.

Building from previous developments of the MCS technique in [8], the operating and failure stages of PCs are established through the use of a random generator, which is assigned to an inverse probability density function (PDF) to convert the input failure rates (λ) and MTTR (μ) values into system states. In this research, the λ values are considered to follow an exponential distribution, while the μ values are modelled using the Weibull distribution, with the two corresponding scale/shape parameters according to [28]. The expressions in (1) and (2) provide general formulae of the PDFs to be considered as inputs for MCS.

$$TTF_{\text{Exponential}} = \text{inv}\{1 - \exp(-\lambda t)\} \quad (1)$$

$$TTR_{\text{Rayleigh}} = \text{inv}\left\{1 - \exp\left(-0.5\left(\frac{t}{\sigma}\right)^2\right)\right\} \quad (2)$$

where σ is the standard deviation of the PDF, and t is the time step.

The simulation is performed on a year-by-year time basis to ascertain the number of customers interrupted and the actual demand not met when a PC fails. For each simulation case, the output data obtained from the probabilistic processing in MATLAB are used as input parameters for representing the stochastic behaviour of the network by applying risk assessment and a power-flow analysis. A simulation loop corresponding to the expected lifetime is introduced following the failure probability distribution. The simulation is halted when convergence is met or when 1000 years elapse. A simulation time of 1000 years in the MCS with a resolution of one-hour time steps is considered sufficient to randomise the behaviour of the network based on a sufficiently low coefficient of variation [29]. Every time a PC fails to operate, a power-flow algorithm is run to check and quantify the number of loads affected. The algorithm is implemented using PSS/E software, automated by Python, to model the analysed distribution network and solve the power flows at each iteration. The frequency and duration of customer interruptions are then assessed and used to compute the standard reliability indicators that depict the overall system's reliability [30].

This analysis considers time-varying demand profiles that more accurately represent the active and reactive power demands at each load point because they contain hourly demand decomposition into different load types [9]. This results in a more realistic assessment of customer interruptions because, at the point of PC failure, the actual demand interrupted is computed and used in deriving energy reliability indices [8]. This MCS procedure also considers the extent to which the probability of network outages is affected by the overall system loading; hence, the time of the day when interruptions occur can be incorporated in the MCS algorithm [29]. This approach for risk and reliability modelling uses relative reliability indices that ensure that any uncertainties in data and system requirements are embedded in all network scenarios. This means that there is high confidence in the relative differences between the indices, which will accurately represent typical system behaviour when maintenance actions are done, or PC operational limits are violated. The next subsections describe the different modelling techniques explored in this paper by probabilistic curve fitting of the failure distribution of PCs.

2.2. Power Component Ageing

Power component ageing directly affects the failure pattern of a PC, as it increases its likelihood to fail and thus negatively impacts system reliability [7]. It is important to emphasise that the age profile of each PC (collected from the utility's historical data) is necessary to allow for an accurate estimation of its probability of failure at a given point during its lifetime [31]. This informs maintenance schedules while feeding into the total asset management of the distribution network.

Previous research considered one value for the expected lifetime for all PCs, e.g., 30 years in [7] and 40 years in [9]. This corresponded to their maximum operating lifetime, and it was assumed that all the components were afterwards replaced. However, this research considers different expected lifetimes for each PC because this ensures that component replacement times are more realistically modelled [11], leading to more accurate reliability results.

2.3. Impact of Time-Varying Failure Rates

Time-varying failure rates are more realistic than average values, as they capture the higher likelihood of failure when the PC has just been installed and when it is near the end of its lifetime [32]. While time-varying failure rates can be reasonably approximated by the mean failure rate, they result in more accurate reliability results when additional system conditions are introduced to the analysis—such as weather-related events, time-varying repair rates and maintenance, and customer interruption costs [7]. Following a bathtub distribution, the PCs will have a reasonably high failure rate following installation during the break-in period that settles to nearly constant during the functional time of the PC before rising towards the end of the PC's lifetime during the wear-out period. This bathtub distribution of the failure rate $\lambda(t)$ is modelled by incorporating a time-varying scaling

factor $\alpha(t)$ to the constant failure rate, $\lambda(c)$ as in (3). This scaling factor follows a beta distribution with a mean value equal to the constant failure rate and is derived considering its fundamental parameters $\alpha_B = \beta_B = 0.5$, as detailed in the model expression (4) [10]. Although $\alpha(t)$ is restricted within the range $[0, 1]$, the failure rates are extrapolated to the PC's expected lifetime to give a more accurate representation than the constant value [22].

$$\lambda(t) = \alpha(t) \cdot \lambda(c) \quad (3)$$

$$\alpha(t) = \text{Beta}_{\text{PDF}} = f(t, \alpha_B, \beta_B) = f(t, 0.5, 0.5) = \frac{1}{\pi\sqrt{t(1-t)}}, \text{ for } t \in [0, 1] \quad (4)$$

An example of such a bathtub distribution for a primary transformer with a mean failure rate $\lambda = 0.01$ failures/year and an expected lifetime of 20 years is shown in Figure 1, where the bathtub distribution is compared to the constant failure rate. Additionally, the failure pattern of PCs depends on a variety of factors: operational conditions, maintenance activities, weather conditions, among others. In this research, the reliability impact of overloading violations and maintenance actions is assessed by probabilistic curve fitting of the aforementioned bathtub distribution to model the resulting failure rate, as described in the following sub-sections.

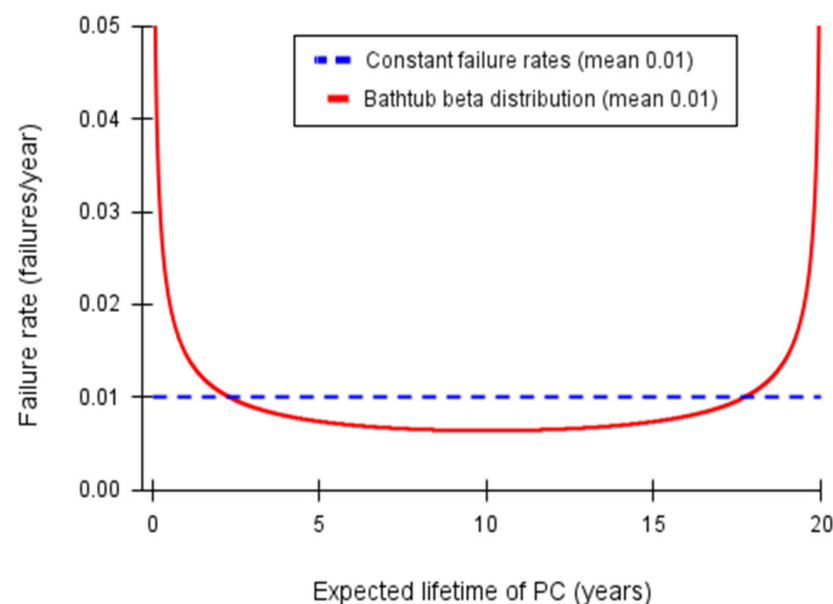

Figure 1. Bathtub distribution for a 33/11 kV primary transformer with a 20-year expected lifetime.

2.4. Impact of Overloading Violations

The problems associated with ageing equipment, such as the increased likelihood of failure previously presented in Section 2.2, are compounded by increased loading [28]. Violations due to overloading accelerate PC deterioration by increasing the failure rate above otherwise expected levels, thus increasing the need for maintenance. It has been shown that lightly loaded transformers and circuit breakers remain in service for longer periods, and their ageing is accelerated by increased loading [15,33,34]. Accordingly, this research only considers circuit breakers and transformers as having their failure rates impacted by overloading violations. Two modelling techniques are proposed: a linear approach where the expected lifetime of the PC is reduced and a nonlinear method that involves skewing the bathtub distribution to have a longer wear-out period and a reduced useful lifetime by incorporating different scaling factors for the break-in period, useful lifetime, and wear-out period.

The proposed nonlinear method involves skewing the bathtub distribution by extending the wear-out period at the expense of the useful lifetime so that the failure rate

deteriorates much earlier in the PC life because of accelerated ageing. In practice, as with the linear method, the extent to which the wear-out period is increased (and useful lifetime reduced) for a particular PC depends on available records from the utility on component age profiles. This failure distribution is modelled by introducing different scaling factors to the constant failure rate during the break-in, useful life, and wear-out periods as in [7]. During the break-in period, the scaling factor decreases exponentially from the maximum to one, where it remains constant for the useful lifetime before increasing exponentially during the wear-out period to the maximum value. The failure rate distribution $\lambda(t)$ is modelled as in (3), with the scaling factor taking on three different shapes as (5)–(7). The scaling factors for the break-in and wear-out periods are chosen to take on decreasing and increasing exponential distributions, respectively, modelled as beta distributions with mean equal to the constant failure rate considering the fundamental parameters $\alpha_B = 1$, $\beta_B = 3$ for the break-in period and $\alpha_B = 5$, $\beta_B = 1$ for the wear-out period [35]. The model expressions for the scaling factors are detailed in (5) and (7).

$$\alpha(t)_{\text{break-in}} = \text{BetaPDF} = f(t, \alpha_B, \beta_B) = f(t, 1, 3) = 3(1-t)^2 \text{ for } t \in [0, 1] \quad (5)$$

$$\alpha(t)_{\text{useful lifetime}} = 1 \quad (6)$$

$$\alpha(t)_{\text{wear-out}} = \text{BetaPDF} = f(t, \alpha_B, \beta_B) = f(t, 5, 1) = 5t^4 \text{ for } t \in [0, 1] \quad (7)$$

An example of the skewed bathtub distribution for a primary transformer with a constant failure rate of 0.01 failures/year and an expected lifetime of 20 years is shown in Figure 2a and compared with the standard bathtub. The mean failure rate for the skewed bathtub (0.012 failures/year) is higher than that of the standard bathtub distribution (0.01 failures/year), implying that degradation in the reliability levels is expected due to an increase in the number of failures experienced by the PC towards the end of its service life.

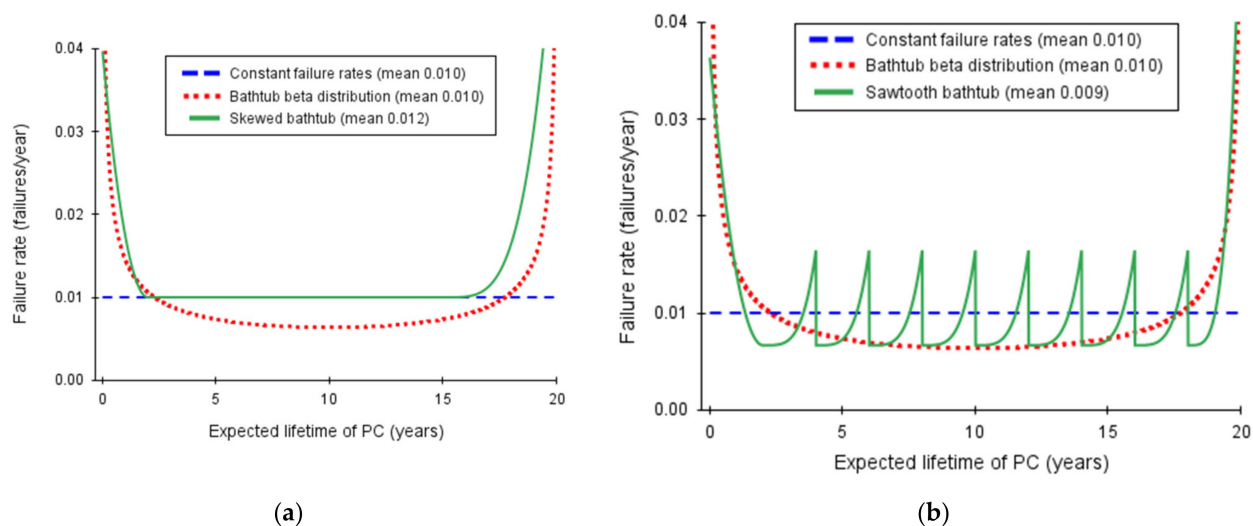

Figure 2. Failure rate distribution functions for a 33/11 kV primary transformer; (a) skewed bathtub distribution; (b) sawtooth bathtub distribution.

In the linear method, accelerated ageing of PCs owing to overloading violations is considered to reduce the expected lifetime and is thus modelled by narrowing the bathtub distribution to vary over a reduced expected lifetime. The extent of the reduction in the expected lifetime is determined from available records on PC replacement and reasonable engineering judgement. In this approach, the distribution of failures over the PC lifetime remains unchanged albeit requiring more frequent replacement. This implies that the system reliability is not expected to change significantly if PCs are replaced at the end of their useful lifetime. However, in practice, the cost of more frequent replacement of PCs is mitigated by increased maintenance to repair faulted PCs.

2.5. Impact of Maintenance Actions

Preventive maintenance (PM) is planned and scheduled maintenance that aims to postpone or reduce failures of a system. A cost-effective approach described in [16] focuses on PCs that have a significant impact on system reliability (and dominant causes of failures) to ensure that the right PCs are maintained at the right time and with the right maintenance activity. This reliability-centred maintenance (RCM) impacts reliability by either improving the working condition of PCs or prolonging their lifetime since the probability of failure is lowered. This paper models the impact of maintenance using two approaches: first, linearly by reducing the mean value of the bathtub distribution to depict the improved working condition of the PCs and then, by a nonlinear approach that introduces the sawtooth bathtub distribution.

In the linear approach, the extent of reduction in the mean failure rate due to maintenance actions depends on the utility's historical information on PC failures and maintenance. Research in [16] proposes that RCM can deliver reliability benefits of up to 10–20% reduction in failure rates of given PCs. Therefore, for this research, the introduction of maintenance is assumed to lead to a 20% reduction in the mean failure rate of all the PCs, thus lowering the bathtub curve and leading to improved reliability results. It is worth noting that PM requires a significant investment that would need to be subjected to a cost-benefit analysis against the resulting reliability benefits to justify the additional investment before any decision is made. Furthermore, consideration for time-varying effects of maintenance actions on failure rates, as in [36], could reveal more about the relationship between maintenance and system reliability to better inform utilities' maintenance strategies.

The nonlinear approach incorporates PM activities into the failure patterns of PCs using the more detailed sawtooth bathtub distribution that models the increasing failure rate between periods after maintenance and shows a reliability improvement after maintenance has been performed. This sawtooth bathtub distribution is modelled through probabilistic curve fitting of the standard bathtub by applying different scaling factors for the break-in, useful lifetime, and wear-out period, as in the nonlinear method proposed for modelling overloading violations in Section 2.4. The failure rate distribution $\lambda(t)$ would then follow, as in (1), with the scaling factors for the break-in and wear-out period taking on the exponential distributions that are detailed in (3) and (5). Detailed modelling of the useful lifetime is then done by applying sawtooth curves corresponding to the periods between maintenance actions. For each sawtooth curve, the failure decreases immediately following the maintenance action and then exponentially increases till the next maintenance action. An increasing exponential distribution, such as the one used in the wear-out period (detailed in (5)), is used to represent the scaling factor for each sawtooth curve. For simplicity, the modelling assumes one maintenance action is done every two years and is adopted from [31], where the failure rate is assumed to fall to two-thirds of the constant failure rate immediately after maintenance before exponentially increasing to 1.5 times the constant failure rate by the next maintenance action. A more accurate model can be developed by the utility based on available records for maintenance and component failures, for example, the more detailed hazard function presented in [31].

An example of a modelled sawtooth distribution for a primary transformer is shown in Figure 2b compared to the standard bathtub and the constant failure rate. It is worth noting that the mean failure rate over the PC lifetime is the same for all three distributions 0.01 failures/year, which reaffirms the assertion that the standard bathtub is an approximation of the sawtooth bathtub [31]. However, given the more accurate representation of the distribution of failures over the PC lifetime, the impact on system reliability is worth scrutinising to assist utilities in making reliability decisions regarding maintenance.

2.6. Reliability Cost-Benefit Analysis

Expected customer interruption cost (ECOST) has been used as a reliability cost/benefit index to quantify the reliability of power systems in monetary terms [1,7,13,14] based on composite customer damage functions. While it can easily be compared with ENS, as it is

customer-specific and is calculated from the load lost during an outage, it does not compare with other system-wide reliability indices, like SAIFI and SAIDI, that depict overall system behaviour [37]. This paper presents the methodology for a reliability cost index that enables the evaluation of customer reliability benefits based on estimating the avoided customer interruption costs that result from a reduction in outage frequency and/or duration. This paper proposes a newly defined System Average Interruption Cost Index (SAICI), which is expressed as a probability distribution and provides a customer perspective to reliability evaluation to facilitate decision making regarding long-term design and planning of distribution reliability. The application of this index can also enable the prioritisation of real-time outage restoration and scheduling of planned outages in the operational planning of distribution networks.

2.6.1. Estimation of Customer Interruption Cost

The accuracy of the calculation of any monetary reliability index is premised on how the cost incurred by customers during outages is estimated [37]. The variability of different customer segments, compounded by the fact that preferences change over time, gives the utility an uphill task of accurately estimating customer interruption costs and thus developing the network to achieve optimal reliability for all customers. A comprehensive overview of the techniques used to estimate customer interruption costs is presented in [38].

In this research, the customer valuation method detailed in [39] is used to quantify the interruption costs by ascertaining the maximum amount customers are willing to pay (WTP) to avoid an interruption and the minimum amount they are willing to accept (WTA) in compensation for an interruption. This method is preferred because it provides the customer perspective through the bottom-up approach and leads to a deeper, more meaningful understanding of customer interruption costs [38]. Value of lost load (VoLL) estimates presented in [36] for residential and commercial customers are adopted in the analysis as the customer interruption costs in £/kWh. For every interruption, the interrupted load in kW is multiplied by the corresponding WTP estimate in £/kWh and the interruption duration in hours to derive the interruption cost that is aggregated for each load during the year to give the total Customer Interruption Cost (CIC) as shown in (8). In some instances, the regulator imposes penalties to the utility (sometimes paid to affected customers) for not meeting set reliability standards, e.g., exceeding set timelines to restore supply to customers after an outage, as in [40]. The success of these penalties in limiting the impact of outages on customers depends on the utility's ability to accurately estimate interruption costs [3].

$$\text{Total CIC} = \sum_{i=1}^n \sum_{j=1}^k \text{WTP estimate} \times \text{Load interrupted} \times \text{Duration of interruption} \quad (8)$$

where k is the number of interruptions per load for n loads in the year.

2.6.2. Formulation of the Cost-Based Index

Research in [1] introduced a risk-based interruption cost index that uses time-based probability distribution functions to model customer interruption costs at different risk levels based on specific customer and interruption parameters. This probabilistic approach is more realistic than the deterministic methods based on average values because its variability more accurately depicts the expected customer costs during interruptions and allows for the inclusion of uncertainties that can be used to relate reliability worth inputs to derived reliability indices. However, this method requires complex modelling, and its applicability to reliability risk assessment will only be investigated in future research.

The monetary reliability index proposed in this research, SAICI, aims to divide the total interruption costs discussed in Section 2.6.1 across all customers to derive the average cost of interruptions per customer during a given period (e.g., a year). SAICI is expressed in £/customer/year and is derived by (9). This system-wide approach means that SAICI can

be compared with SAIDI and SAIFI directly, as it correlates to the frequency and duration of outages experienced.

$$\text{SAICI} = \frac{\text{Total CIC}}{\text{Number of customers}} \quad (9)$$

3. Validation and Network Modelling

The reliability modelling methodology introduced in Section 2 is validated to assess the impact of the different operational constraints on the accuracy of reliability performance results. Different network scenarios are simulated, and the reliability results are compared to show a decision-making approach that can be applied to integrated reliability planning of distribution networks.

3.1. Network Design

The test network model used for the analysis is shown in Figure 3 and is extracted from [41], with loads classified as being residential and commercial at low voltage (LV) levels. Generic network models, as in [42], that emulate typical configurations are used to represent the actual distribution system after the load at each network node has been identified. The network model consists of a 2.5 MVA 33/11 kV primary transformer supplying two feeders back-fed with an 11 kV overhead line and a normally open fuse switch. One feeder is an overhead line that serves three residential LV load points (LP), LP2–LP4, through 100 KVA 11/0.4 kV distribution transformers, while the other is an underground cable that supplies a commercial LV load point LP-1 through a 100 kVA distribution transformer.

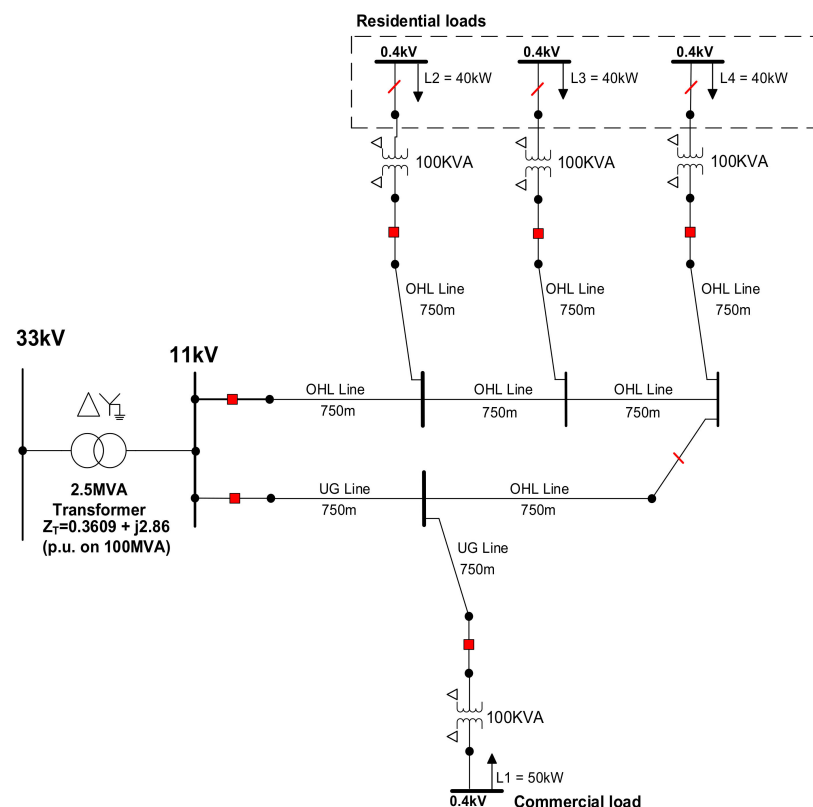

Figure 3. Distribution test network model.

The network model is selected to consist of the two feeders to provide insights into the difference in reliability performance of loads supplied by overhead lines and underground cables. Detailed data about the parameters of the PCs are provided in [21], and the reliability data showing the component failure rates (λ) mean time to repair (μ) and expected lifetime

(EL) are shown in Table 1. This research uses real PC reliability data (failure rates and repair times) that accurately represent the realistic behaviour of typical distribution networks. A comprehensive simulation of sustained outages in a realistic distribution network is performed considering all the technical issues at the time of assessing the reliability and economic performance of the system.

Table 1. Component reliability data.

Power Component	λ (/year)	μ (h)	EL (years)
33 kV bus	0.08	140	25
11 kV bus	0.05	120	25
415 V bus	0.05	24	25
33/11 kV Transformer	0.01	205.5	20
11/0.4 kV Transformer	0.002	75	10
Circuit breaker	0.0033	120.9	10
Fuse (11 kV and LV)	0.0004	35.3	20
Overhead line	0.091 *	9.5	25
Underground cable	0.051 *	56.2	25

* Failure rates for are per km and are multiplied by line length.

The daily demand curve for the loads is derived from the after diversity maximum demand (ADMD) for each load point that is defined as the maximum demand per customer as the number of customers approaches infinity. The ADMD is derived from the maximum yearly nodal demand on the distribution network divided by the number of customers at the node, providing a much more representative load model [43]. This paper models the ADMD for residential and commercial loads as 40 kW and 50 kW, respectively [43]. The resulting typical aggregate daily load demand curves for each load category are shown in Figure 4. It can be seen that the commercial daily load curve has a high demand during the day when business activities are ongoing, while the residential load curve has a higher demand in the evening and early morning (albeit to a lower extent), when people are typically active at home.

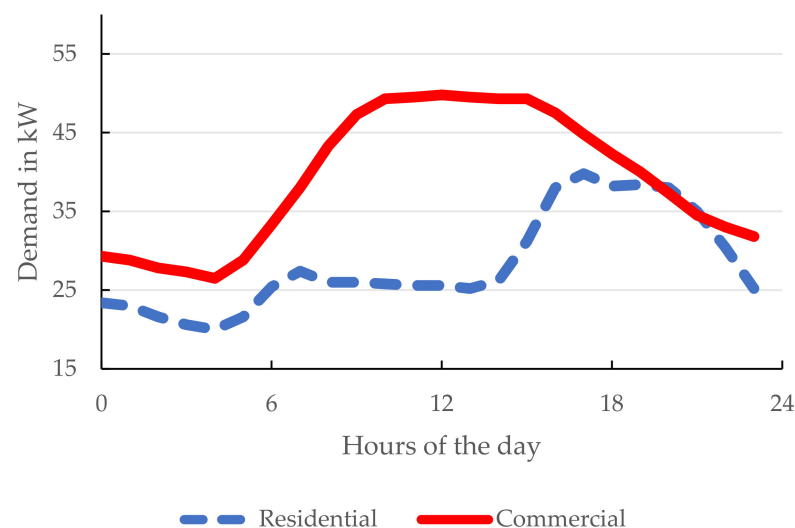

Figure 4. Aggregate daily load demand curves for commercial and residential loads [43].

3.2. Network Scenarios

The network presented in Figure 3 is modelled in the PSS/E software package, automated by Python, while the different network scenarios and functionalities are scripted in MATLAB to model the probability distributions of the input failure rates and repair times for time-sequential MCS, as in [9]. The reliability performance between different scenarios is evaluated by comparing the average values of the reliability indices as well as

their Probability Distribution Functions (PDFs). Table 2 summarises the network scenarios with their detailed descriptions provided in the subsequent subsections.

Table 2. Network scenarios.

ID	Scenario	Description
S-1	Constant failure rates	Fixed failure rates
S-2	Base case	Time-varying failure rates
S-3	Overloading violations; non-linear method	Longer wear-out
S-4	Overloading violations; linear method	Reduced lifetime
S-5	High-frequency maintenance; linear method	Reduced failure rate
S-6	Low-frequency maintenance; nonlinear method	Sawtooth bathtub curves

3.2.1. S-1 Constant Failure Rates

The basic case considers PCs to have constant failure rates. This scenario represents oversimplified modelling, which does not accurately account for changing operational conditions throughout the PC's expected lifetime. Accordingly, results from this scenario are only indicative of system behaviour but do not offer appreciable benefits in terms of accuracy for the analysis.

3.2.2. S-2 Base Case

The base case is used as a point of reference to determine the benefits/drawbacks of other considered scenarios when the reliability performance of the network model shown in Figure 3 is assessed. This is because it accurately represents the behaviour of the network under normal conditions. This base case is modelled with the failure rate of each PC following the bathtub distribution over its expected lifetime, as presented in Section 2.3. The calculated reliability indices from the other scenarios are compared against each other and against the base case to quantify the reliability improvement/detriment in percentage terms. This approach ensures that uncertainties in data and system requirements are embedded in all the indices, thereby affording reasonable confidence in the relative differences between scenarios upon which the conclusions and recommendations from the analysis are made [11].

3.2.3. Violations Due to Overloading

A. S-3 Non-linear Method Modelled by Skewing Bathtub

In S-3, the failure distribution is modelled by skewing the bathtub distribution to have a longer wear-out period as the nonlinear method presented in Section 2.4. This scenario is expected to worsen reliability significantly and support the reasoning that overloading an electric circuit supplying commercial and domestic customers for extended periods worsens system reliability by increasing the duration and frequency of interruptions [44]. This is because the mean failure rate is higher than the constant failure rate. In this scenario, the bulk of the additional cost imposed by continuously violating overloading limits is expected to be incurred by the customers due to the deteriorated reliability, as additional network costs for replacing PCs faster would be minimal since PCs are replaced at the end of their expected lifetime albeit having a prolonged wear-out period.

B. S-4 Linear method modelled by reducing PC lifetime

In S-4, the accelerated ageing caused by the violation of overloading limits is modelled by reducing the expected lifetime as the linear method described in Section 2.4. There is no significant deterioration in reliability expected in this scenario, as the mean failure rate over the PC lifetime is the same as the base case, but higher network costs for replacing PCs more frequently will invariably be incurred by the utility. The bulk of the additional cost for violating overloading limits would then be incurred when replacing PCs, with a minimal increment in the interruption cost to customers.

3.2.4. Maintenance Actions

A. S-5 High-frequency maintenance modelled by a linear method of lowering bathtub

High-frequency maintenance is modelled in S-5 by reducing the mean failure rate of the bathtub distribution to depict the improved working condition of the PCs. A resulting improvement in the system reliability is expected; however, an analysis of the costs is required to ensure the resulting reliability improvement outweighs the incremental cost of the maintenance. This is required to justify the additional investment required.

B. S-6 Low-frequency maintenance modelled by a nonlinear method of sawtooth bathtub distribution

Low-frequency maintenance is modelled as a sawtooth bathtub distribution (described in Section 2.5) with exponential distributions after each maintenance action during the useful lifetime. While this distribution depicts periodic maintenance that is conducted irrespective of the increase in failures, utilities often adopt different maintenance strategies, such as condition-based and reliability-centred maintenance, detailed in [36], that responds to the condition of the PCs. The sawtooth distribution is expected to produce reliable results close to those when the standard bathtub is considered. Scrutinising the costs also allows for a cost-benefit analysis of the reliability benefits vis-à-vis the maintenance investment cost to provide economic justification for the utility. Further analysis based on more accurate information on the behaviour of PCs can be focused on comparing the reliability benefits of adopting different maintenance strategies.

4. Reliability Performance Assessment

The reliability results from the study are presented in this section using standard reliability indices for interruption duration (SAIDI), interruption frequency (SAIFI), interruption cost (SAICI), and energy not supplied (ENS). These indices are presented using average values and probability density functions (PDFs) to highlight the stochastic variability of network performance while providing insight into the potential benefits that may not be immediately obvious with average values. It is validated that constant failure rates overestimate reliability results by up to 36.7% for SAIDI, 36.8% for ENS, 36.5% for SAICI, and 13.7% for SAIFI. LP-1 experiences the longest and highest number of interruptions because it is supplied by a radial underground cable, followed by LP-4, which is furthest from the primary transformer. There is a consistent reduction in all reliability indices when overloading violations are modelled, with S-3 producing less realistic results than S-4 due to its more realistic non-linear modelling approach. Preventive maintenance actions modelled in S-5 and S-6 lead to an improvement in all reliability indices, with a smaller rise for S-6 because the sawtooth distribution is an approximation of the standard bathtub.

4.1. Constant vs. Time-Varying Failure Rates

Table 3 shows an improvement in all reliability indices when time-varying failure rates that follow a bathtub distribution are considered over the expected lifetime as in S-2 (base case) compared to the S-1 (basic case) that models constant failure rates. There is a significant reduction in the duration of interruptions (36.7%), energy not supplied (36.8%), and interruption cost (36.6%), with a smaller reduction in the frequency of interruptions (13.7%). This means that when the simplified constant failure rates are used in a reliability performance assessment, reliability results are expected to be overestimated by up to 36% for interruption duration and 13% for interruption frequency. While the development of a failure distribution over the PC lifetime hinges on the collection of component failure and outage records over time, the improved accuracy in reliability results is justifiable, as decisions on reliability investments can be better informed.

Table 3. Comparison of reliability indices for constant and time-varying PC failure rates.

ID	Scenario	SAIFI (int/cust/yr)	SAIDI (h/cust/yr)	ENS (kWh/cust/yr)	SAICI (£/cust/yr)
S-1	Constant failure rates	0.153	12.731	392.63	2844.40
S-2	Bathtub beta distribution	0.132	8.060	248.02	1804.56
Percent decrease		13.70%	36.70%	36.83%	36.55%

cust, customer; int, interruption; yr, year; h, hours.

Figure 5 demonstrates that customers at LP-1 and LP-4 experience longer interruptions (8.630 h and 8.634 h, respectively) than customers at LP-2 and LP-3 (7.177 h and 7.798 h, respectively). This is because LP1 is solely fed by an underground cable compared to the overhead lines supplying LPs 2–4. Although cables typically have lower failure rates than overhead lines because they are protected from common causes of failures, like vegetation, adverse weather, and above the ground obstructions, they also usually require long restoration/repair times for point-of-fault identification. Not to mention, repair works involving cable jointing are usually extensive. Therefore, the network configuration should ensure underground networks are either meshed or supported by another supply point when radial to improve reliability to connected customers. LP-4 experiences longer interruptions because it is further from the primary transformer than all other load points, meaning that customers who are located along with the feeders further away from the grid substations will tend to experience longer durations than those at the beginning of the feeder, which is nearer to the grid supply point.

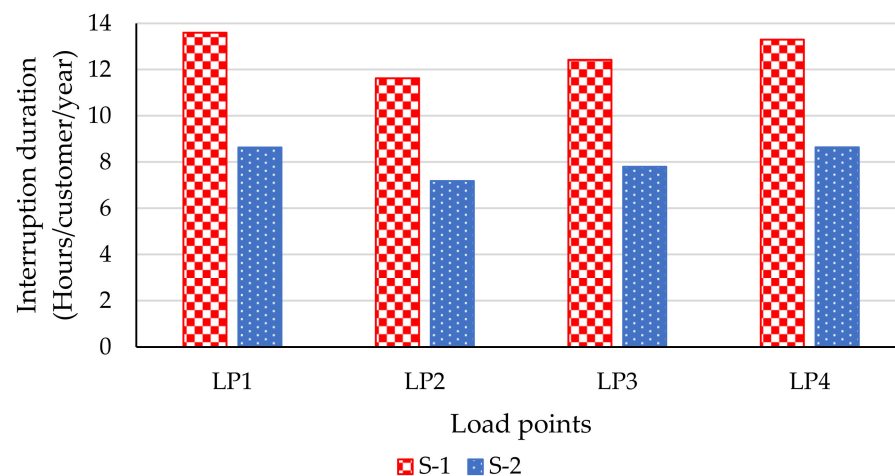
**Figure 5.** Comparison between average interruption durations for S-1 and S-2.

4.2. Impact of Overloading Violations

There is a consistent reduction in all reliability indices when overloading violations are modelled. The non-linear approach, modelled by skewing the bathtub distribution, yields a more significant reduction than the linear approach, which is modelled by reducing the PC lifetime. Table 4 shows that while SAIDI and SAIFI in S-3 increase by 18.54% and 7.34%, respectively, these reductions are only 5.15% and 1.65% in S-4. The increased frequency and duration of interruptions are due to the increased probability of failure of PCs brought about by violating overloading limits. S-4 presents a lower reduction in reliability indices than S-3 when compared to the base case because the failure distribution is not altered, but rather the frequency of PC replacement is increased, whereas in S-3, the failure distribution of the PCs is skewed for the exponential rise in failures (typically in the wear-out period) to begin earlier in the PC lifetime than in the base case. It follows that the reliability results for ENS and SAICI increase by 19.32% and 26.06% in S-3, respectively, presenting only 5.22% and 4.59% increments in S-4.

Table 4. Reliability indices due to violations of overloading limits.

ID	Scenario	SAIFI (int/cust/yr)	SAIDI (h/cust/yr)	ENS (kWh/cust/yr)	SAICI (£/cust/yr)
S-2	Base case	0.132	8.059	248.02	1804.56
S-3	Overloading violations by skewing bathtub to have longer wear-out	0.143	9.554	295.93	2274.80
	Percent increase from the base case	7.34%	18.54%	19.32%	26.06%
S-4	Overloading violations by reducing PC lifetime	0.135	8.475	260.97	1887.45
	Percent increase from the base case	1.65%	5.15%	5.22%	4.59%

cust, customer; int, interruption; yr, year; h, hours.

S-3 is a more realistic representation of overloading violations, as utilities will not typically replace PCs before their expected lifetime due to economic constraints. They usually opt for longer wear-out periods, when failures are highest, before replacement. Further, S-3 assesses the impact of overloading on the failure pattern over the PC's lifetime, i.e., accelerated ageing, thus providing a more accurate representation of the impact on reliability. This incentivises utilities to further investigate the behaviour of PCs based on historical information and enact data-driven planning and operational decisions for the improvement of the reliability of the electricity supply.

In S-4, while the modelling does not result in a significant rise in reliability indices, the impact on utilities is through the more frequent replacement of PCs required to maintain the reliability levels as PCs age faster. Notably, the cost to the utility from the more frequent replacement of PCs due to the reduced lifetime is worth more scrutiny, as discussed in Section 4.2.2.

Figure 6 shows that the commercial load point LP-1 is affected most by violations due to overloading, as it presents the highest rise in average interruption duration (25.98%) from S-2 to S-3 compared to the other load points LP-2 (20.80%), LP-3 (21.12%), and LP-4 (6.87%). As previously discussed in Section 4.1, LP-1 experiences longer durations than other LPs owing to its underground cable supply that is characterised by long repair times, and this is exacerbated by overloading violations. This signifies that the utility should focus its efforts to ensure overloading limits are not violated in parts of the networks with longer and more frequent interruptions, as they will experience worse reliability degradation than more reliable parts of the network irrespective of the driver of the PC failures.

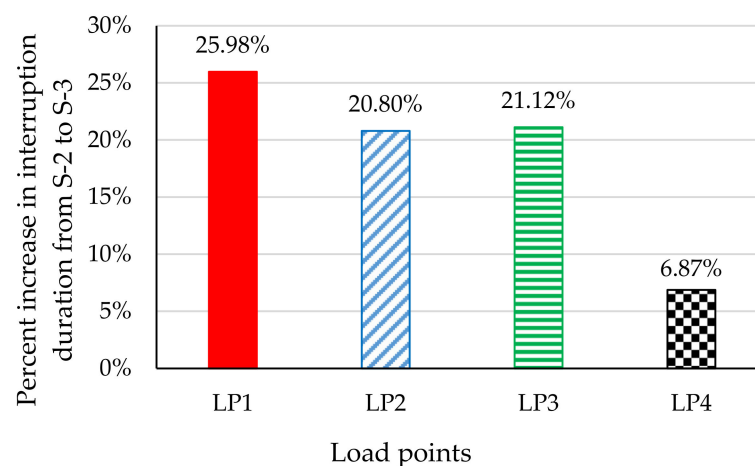
**Figure 6.** Percentage increase in average interruption duration from S-2 to S-3.

4.2.1. Interruption Duration and Frequency

There is a 7.34% rise in SAIFI from S-2 to S-3 and a 2.07% rise from S-2 to S-4 where overloading violations are introduced, indicating an increased number of sustained interruptions per customer. SAIDI rises by 18.54% and 5.15% from S-2 to S-3 and S-4, respectively, as shown in Table 4. This significant deterioration in SAIDI and SAIFI arises from a higher mean failure rate in S-3 as a result of the overloading violations that lead to a prolonged wear-out period, where failure rates increase exponentially at the expense of reduced useful lifetime, where failure rates are constant, i.e., accelerated ageing. There is a higher increase in the average duration of interruptions (18.54% for S-3) than in the average number of interruptions (7.34% for S-3). This means that while customers may experience a small increase in the number of interruptions, their duration will be significantly longer when the network is operated such that overloading limits are exceeded.

The reliability degradation evidenced by increased frequency and duration of interruptions due to violation of overloading limits underpins the need for increased regulatory scrutiny on the operating conditions of the various parts of the network to ensure reliability improvement investments by the utility are directed towards de-congesting overloaded parts of the network. This result also provides additional justification for utilities to collect accurate outage records that can inform strategies to reduce outage costs and lost revenue due to poor continuity of supply.

The probability distribution functions of SAIFI for the base case (S-2), S-3, and S-4 shown in Figure 7a reveal that S-3 has a shorter tail than the base case, reducing the largest plausible number of interruptions that can be experienced by a customer in a year from 2.8 to 2.2. While the average number of interruptions per customer increases in S-3, the distribution of failures is such that the worst affected customers experience fewer interruptions than in the base case. This observation explains why the impact of overloading violations may often go unnoticed when benchmarked against the number of interruptions experienced by the worst-affected customer. Figure 7a also shows that the failure distribution of the frequency of interruptions in S-4 does not differ much from S-2 since it follows an identical bathtub distribution (described in Section 2.4).

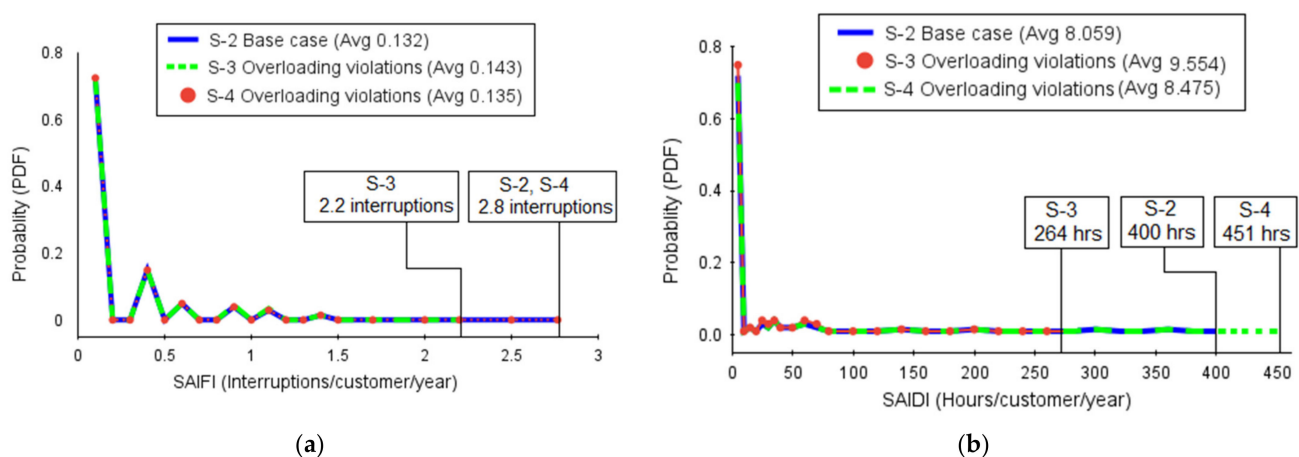

Figure 7. PDFs of S-2, S-3, and S-4 for (a) SAIFI; (b) SAIDI.

Figure 7b shows the resulting PDF for SAIDI that reveals a shorter tail for S-3 (264 h/customer/year) in contrast to a longer tail for S-4 (451 h/customer/year) when compared to the base case (400 h/customer/year). This translates to the longest plausible interruption duration experienced by the worst-affected customer increasing in S-4 and reducing in S-3 when compared to the base case, meaning the worst-affected customer will incur shorter outages in S-3 and longer outages in S-4 than in the base case.

4.2.2. Energy Not Supplied and Interruption Cost

Table 4 shows that ENS increases by 19.32% in S-3 and by 5.22% in S-4 compared to the base case, which is consistent with the degradation of SAIDI and SAIFI discussed previously in Section 4.2.1, where customers experience more frequent and sustained interruptions as a result of PCs failing more often when they are overloaded above their limits. In turn, SAICI increases by 26.06% for S-3 and 4.59% for S-4 from the base case. Figure 8 shows that the increase in SAICI from S-2 to S-3 is significantly higher than the increases in SAIFI (7.34%), SAIDI (18.54%), and ENS (19.32%). This reveals that customers are impacted the most by the onset of overloading violations because they endure longer durations of outages. In the public interest, the regulator ought to incentivise the utility to minimise the additional customer cost imposed by the overloading violations by making optimal reliability investments, for example, when penalties are imposed for outages lasting longer than a prescribed limit, utilities will incur higher penalties for the prolonged interruptions when overloading limits are violated.

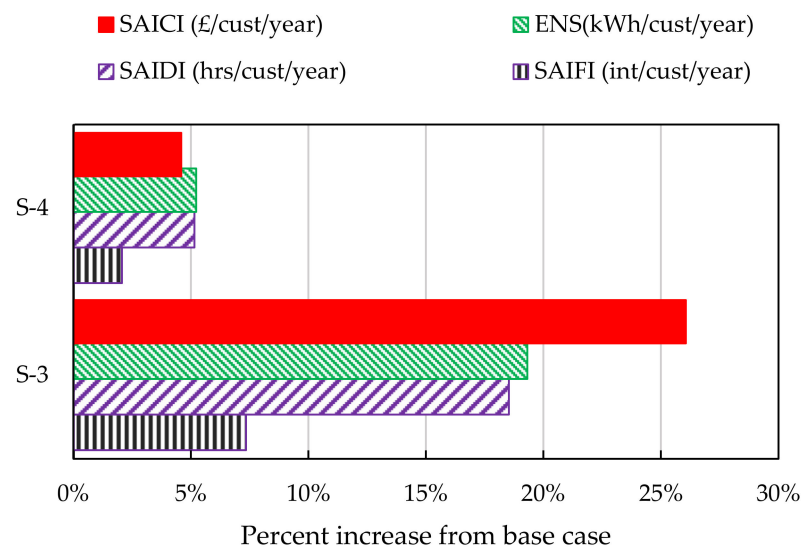

Figure 8. Percentage changes in SAIDI, ENS, and SAICI for S-3 and S-4 from the base case.

The PDFs for ENS shown in Figure 9 are consistent with the results for SAIDI, with S-3 having a shorter tail and S-4 having a slightly longer tail when compared to the base case. This is consistent with the observed trend from Figure 7b of the longest plausible interruption durations increasing for S-4 with a longer tail and reducing for S-3 with a shorter tail; the shorter tail in S-3 means that overloading violations will reduce the ENS for the worst-affected customer in S-3 while increasing in S-4. This emphasises the importance of utilities not basing the reliability performance of the system on the worst-affected customers but rather system-wide averages for more informed decisions. It is worth noting that while the modelling in S-4 where PC lifetimes are reduced may appear to have a small impact on the reliability indices considered in this study, the fact that PCs are replaced in a shorter time would mean a significant impact on network costs.

4.3. Impact of Maintenance Actions

The results from the reliability performance assessment of the network show an improvement in all reliability indices when maintenance actions are introduced. However, the high-rate maintenance modelled in S-5 shows a larger improvement in reliability results as compared to the low-rate maintenance in S-6, where a sawtooth distribution is modelled. This is because the sawtooth modelling considers the momentary rise in the probability of failure immediately after a maintenance action, equivalent to the break-in period, owing to maintenance crews' remedial works during installation and re-assembly. Reliability improvements in S-5 are a result of a reduced mean failure rate resulting from preventive

maintenance. Table 5 provides a summary of the reliability indices derived from the performance assessment of S-5 and S-6.

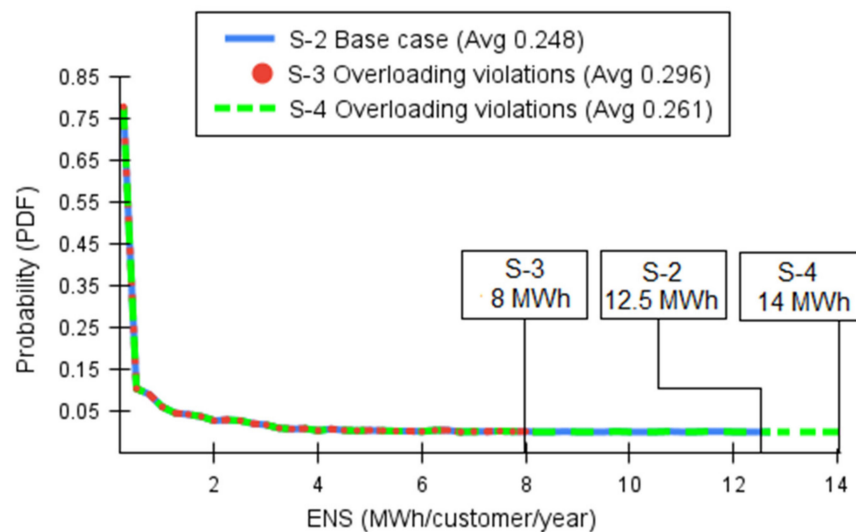

Figure 9. PDFs of ENS for SAIDI and SAIFI.

Table 5. Reliability indices due to implementation of maintenance actions.

ID	Scenario	SAIFI (int/cust/yr)	SAIDI (h/cust/yr)	ENS (kWh/cust/yr)	SAICI (£/cust/yr)
S-2	Base case	0.132	8.06	248.02	1804.56
S-5	High-frequency maintenance actions by lowering bathtub	0.112	7.13	219.12	1560.41
	Percent decrease from the base case	15.25%	11.57%	11.65%	13.53%
S-6	Low-frequency maintenance actions by sawtooth curves	0.131	7.88	239.74	1721.19
	Percent decrease from the base case	1.02%	2.29%	3.34%	4.62%

cust, customer; int, interruption; yr, year; h—hours.

4.3.1. Interruption Duration and Frequency

Table 5 shows an 11.57% and 15.25% reduction in SAIDI and SAIFI, respectively, for S-5 from the base case, while in S-6, SAIDI and SAIFI reduced by 2.29% and 1.02%, respectively. It can be seen that the relative reductions in SAIDI and SAIFI are within the same range for both scenarios, meaning the introduction of maintenance reduces the interruption frequency and duration proportionately. Figure 10 shows the average duration of interruptions experienced at each of the load points for S-5 and S-6, highlighting consistent reductions from the base case.

It is expected that following introduction of maintenance actions, LP-2 and LP-3 will experience bigger improvements in interruption duration since they were least affected by overloading violation in Section 4.2, where LP-1 and LP-4 experience the longest and most frequent outages. Accordingly, customers with already reliable supply will benefit most from maintenance. Additionally, the modelling assumes maintenance to be conducted on the entire network uniformly, while in practice, maintenance crews tend to focus on the parts of the network with many failures.

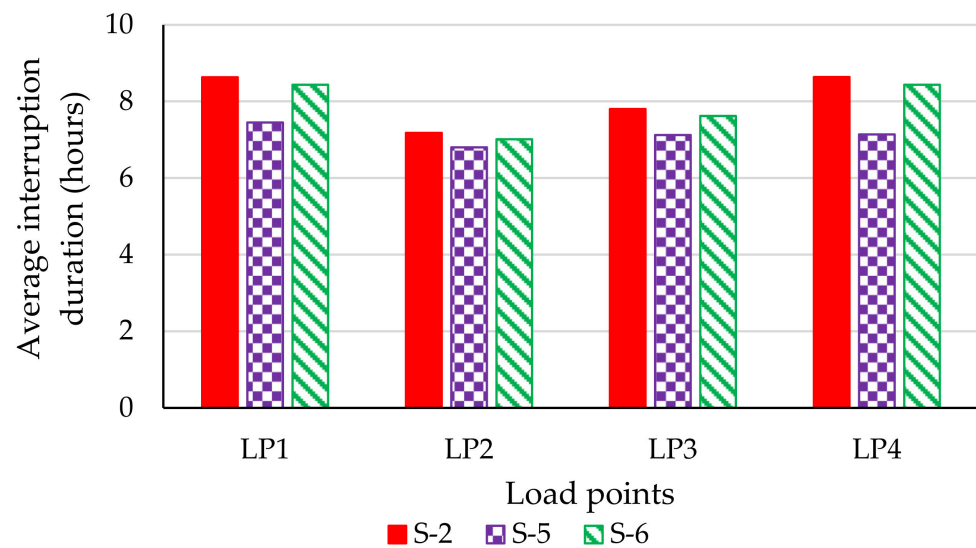

Figure 10. Comparison between the interruption durations for each LP in S-5 and S-6.

A closer look at the PDFs for SAIFI shown in Figure 11a reveals that S-5 and S-6 have shorter tails than the base case, meaning a reduction in the highest number of interruptions experienced by a customer from 2.8 in S-2 to 2.5 in S-6 and 1.8 in S-5. This implies that the introduction of maintenance actions reduces the probability of very many interruptions to customers, as maintenance reduces the probability of PCs failing. Figure 11b shows the PDF of SAIDI for S-5 and S-6 and the base case, and it reveals that the introduction of maintenance actions increases the probability of the longest possible interruption. While the longest possible interruption duration experienced in a year is 400 h in the base case, it increases to 540 h for S-5 and S-6, a 35% increase. This means that maintenance causes an increase in the interruption duration for the worst-affected customers albeit reducing the average for all customers.

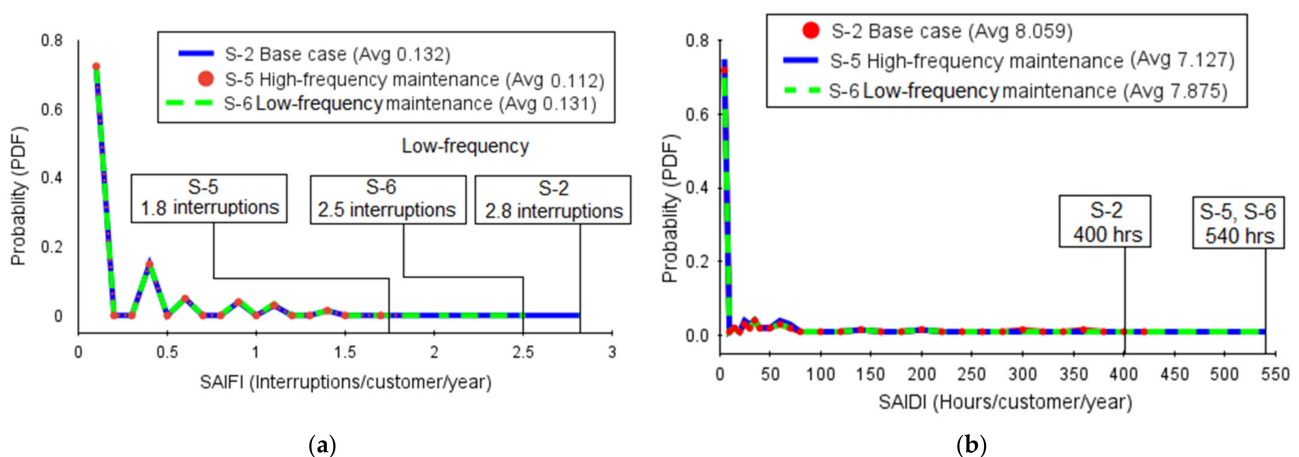

Figure 11. PDFs of S-2, S-5, and S-6 for (a) SAIFI; (b) SAIDI.

4.3.2. Energy Not Supplied and Interruption Cost

Table 5 shows a reduction in ENS of 11.65% for S-5 and 3.34% for S-6 when compared to the base case (S-2). This is due to the reduction in the duration of interruptions when maintenance is introduced, as discussed in Section 4.3.1, where S-5 shows a bigger improvement than S-6. It is worth noting that the improvements in ENS are proportionate to the reductions in SAIDI for both scenarios, as they are both duration-based indices. SAICI reduces by 13.53% for S-5 and 4.62% for S-6 when compared with the base case.

This is consistent with the observation in Section 4.2, and it follows that improvements in SAICI are greater than those in ENS, SAIDI, and SAIFI when maintenance is introduced. This is important because it shows that customers benefit more than the utility from reliability improvements (shorter and less frequent interruptions) arising from the maintenance actions.

The PDFs of ENS for S-5 and S-6 when compared to the base case are shown in Figure 12 and reveal that introduction of maintenance leads to a longer tail than the base case, with the maximum possible ENS increasing from 12.8 MWh for S-2 to 16.4 MWh for S-5 and S-6. This is consistent with the observation from Section 4.3.1, where the PDF of SAIDI (Figure 11b) showed that the probability of the longest possible interruptions increases.

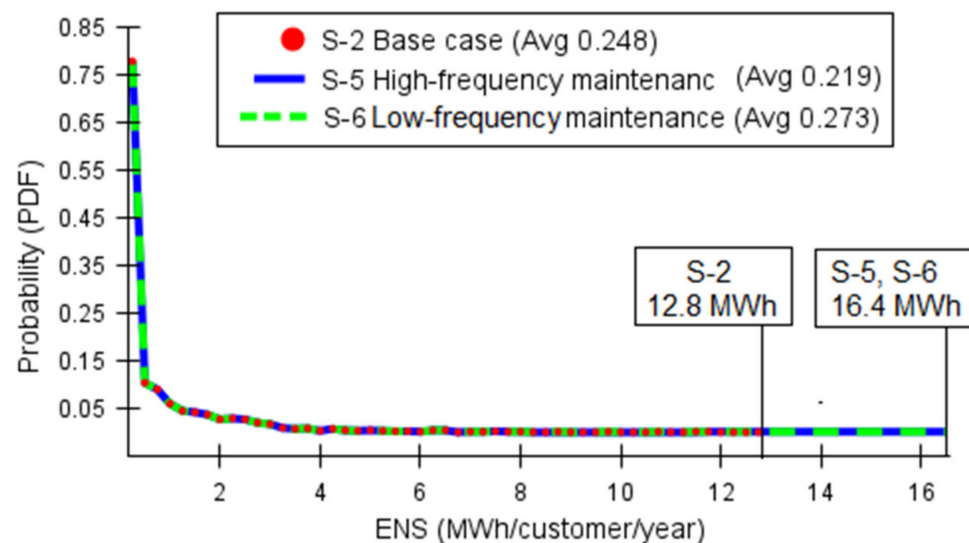

Figure 12. PDFs of ENS for S-2, S-5, and S-6.

5. Conclusions

This paper conducts a lifetime beta modelling of failure rates in the reliability risk assessment of distribution networks. This study builds on conventional reliability analyses by considering different expected lifetimes for each component to more realistically depict utility practice. A novel technique is introduced to model different operational constraints by the probabilistic fitting of the bathtub distributions of PC failure rates. The stochastic behaviour of a network model is simulated, and a reliability performance assessment is conducted to calculate the system-wide reliability indices.

A new cost index, SAICI, is derived and expressed as a probability distribution to be compared with standard reliability indices to provide a customer perspective to the reliability performance results. The study shows that customers experience longer and more frequent outages when the network is overloaded above rated limits because the probability of failure of PCs is significantly increased. The cost-benefit analysis reveals that customers are impacted most by the onset of overloading violations because they endure longer durations of outages and have to incur significant costs for alternatives. This study provides an incentive for utilities to track cost-based reliability metrics to provide a wider understanding of the total cost of reliability to network planning and operation.

Key contributions from the research include:

- Novel component lifetime modelling of failure rate distributions;
- Modelling of different network operational conditions using probabilistic curve fitting of the bathtub distribution; and
- Reliability cost-benefit analysis of operating the distribution network under different operational constraints.

The findings from this research will provide new considerations for utilities and regulators to make better-informed decisions regarding reliability investments. Reliability planners can utilise historical records of outages and component failures to build more accurate component age profiles that can be incorporated into reliability assessments for more dependable results. This research can be expanded for a larger network while incorporating more technical factors, such as more individualised component lifetimes based on manufacturer specifications and utility data and location-based overloading violations that account for security-constrained economic dispatch, among others. The impact of operating the network under different operational constraints on the system reliability will be a key criterion for investments to improve the quality of supply to customers.

Author Contributions: Conceptualisation, M.B.N. and I.H.-G.; methodology, M.K., M.B.N. and I.H.-G.; software, M.K. and M.B.N.; validation, M.B.N. and I.H.-G.; formal analysis, M.K., M.B.N. and I.H.-G.; investigation, M.K.; writing—original draft preparation, M.K.; writing—review and editing, J.S., J.N.-K., M.B.N. and I.H.-G.; supervision, J.S., J.N.-K., M.B.N. and I.H.-G. All authors have read and agreed to the published version of the manuscript.

Funding: This research received no external funding.

Institutional Review Board Statement: Not applicable.

Informed Consent Statement: Not applicable.

Data Availability Statement: Not applicable.

Conflicts of Interest: The authors declare no conflict of interest.

References

- Dzobo, O.; Gaunt, C.; Herman, R. Investigating the use of probability distribution functions in reliability-worth analysis of electric power systems. *Int. J. Electr. Power Energy Syst.* **2012**, *37*, 110–116. [[CrossRef](#)]
- Peyghami, S.; Fotuhi-Firuzabad, M.; Blaabjerg, F. Reliability Evaluation in Microgrids with Non-Exponential Failure Rates of Power Units. *IEEE Syst. J.* **2020**, *14*, 2861–2872. [[CrossRef](#)]
- Alvehag, K. Impact of Dependencies in Risk Assessments of Power Distribution Systems. Ph.D. Thesis, KTH Royal Institute of Technology, Stockholm, Sweden, 2008.
- Dzobo, O.; Gaunt, C.T.; Herman, R. Customer interruption cost for composite reliability analysis. In Proceedings of the Probabilistic Methods Applied to Power Systems (PMAPS), Istanbul, Turkey, 10–14 June 2012.
- Brown, R.; Marshall, M. Budget constrained planning to optimize power system reliability. *IEEE Trans. Power Syst.* **2000**, *15*, 887–892. [[CrossRef](#)]
- Bowles, J. Commentary—caution: Constant failure-rate models may be hazardous to your design. *IEEE Trans. Reliab.* **2002**, *51*, 375–377. [[CrossRef](#)]
- Retterath, B.; Venkata, S.; Chowdhury, A. Impact of time-varying failure rates on distribution reliability. *Int. J. Electr. Power Energy Syst.* **2005**, *27*, 682–688. [[CrossRef](#)]
- Hernando-Gil, I.; Ilie, I.; Djokic, S.Z. Reliability planning of active distribution systems incorporating regulator requirements and network-reliability equivalents. *IET Gener. Transm. Distrib.* **2016**, *10*, 93–106. [[CrossRef](#)]
- Ndawula, M.B.; Djokic, S.Z.; Hernando-Gil, I. Reliability Enhancement in Power Networks under Uncertainty from Distributed Energy Resources. In Proceedings of the 18th IEEE International Conference on Environment and Electrical Engineering, Palermo, Italy, 12–15 June 2018.
- Ilie, I.-S.; Hernando-Gil, I.; Djokic, S.Z. Risk assessment of interruption times affecting domestic and non-domestic electricity customers. *Int. J. Electr. Power Energy Syst.* **2014**, *55*, 59–65. [[CrossRef](#)]
- Ndawula, M.B. Aggregated Impact of Smart Grid Technologies on the Quality of Power Supply. Ph.D. Thesis, University of Bath, Bath, UK, 2021.
- Wang, P.; Billington, R. Reliability cost/worth assessment of distribution systems incorporating time-varying weather conditions and restoration resources. *IEEE Power Eng. Rev.* **2001**, *21*, 63. [[CrossRef](#)]
- Bhargava, C.; Murty, P. Reliability evaluation of radial distribution system using analytical and time sequential techniques. In Proceedings of the 2016 7th India International Conference on Power Electronics (IICPE), Patiala, India, 17–19 November 2016; pp. 1–6.
- Agarwal, U.; Jain, N. Reconfiguration of Radial Distribution Network for Reliability Enhancement considering Renewal Energy Sources. In Proceedings of the 2020 International Conference on Electrical and Electronics Engineering (ICE3), Gorakhpur, India, 14–15 February 2020; pp. 162–167.

15. Rashid, N. Short-Time Overloading of Power Transformers. Ph.D. Thesis, Royal Institute of Technology KTH Stockholm, Stockholm, Sweden, 2011.
16. Bertling, L.; Allan, R.; Eriksson, R. A Reliability-Centered Asset Maintenance Method for Assessing the Impact of Maintenance in Power Distribution Systems. *IEEE Trans. Power Syst.* **2005**, *20*, 75–82. [[CrossRef](#)]
17. Li, F.; Brown, R. A Cost-Effective Approach of Prioritizing Distribution Maintenance Based on System Reliability. *IEEE Trans. Power Deliv.* **2004**, *19*, 439–441. [[CrossRef](#)]
18. Piasson, D.; Biscaro, A.; Leão, F.B.; Mantovani, J.R.S. A new approach for reliability-centered maintenance programs in electric power distribution systems based on a multiobjective genetic algorithm. *Electr. Power Syst. Res.* **2016**, *137*, 41–50. [[CrossRef](#)]
19. Afzali, P.; Keynia, F.; Rashidinejad, M. A new model for reliability-centered maintenance prioritisation of distribution feeders. *Energy* **2019**, *171*, 701–709. [[CrossRef](#)]
20. Logan, D.M.; Papic, M. A Survey of Industry Practices in Probabilistic Assessment and Composite System Reliability Analysis. In Proceedings of the 2020 International Conference on Probabilistic Methods Applied to Power Systems (PMAPS), Liege, Belgium, 18–21 August 2020; pp. 1–6.
21. Bagen, B.; Moura, J.; Jefferies, K. Probabilistic reliability assessment of North American Electric Power Systems. In Proceedings of the 2014 International Conference on Probabilistic Methods Applied to Power Systems (PMAPS), Durham, UK, 7–10 July 2014; pp. 1–6.
22. Gil, I.H. *Integrated Assessment of Quality of Supply in Future Electricity Networks*; The University of Edinburgh: Edinburgh, UK, 2014.
23. Cha, J.; Park, J.; Choi, J.; Jung, Y.; Yun, Y. Determination of a deterministic reliability criterion for composite power system expansion planning. In Proceedings of the 2009 IEEE Power & Energy Society General Meeting, Calgary, AB, Canada, 26–30 July 2009; pp. 1–6. [[CrossRef](#)]
24. Heylen, E.; Ovaere, M.; Deconinck, G.; Van Hertem, D. Fair Reliability Management: Comparing Deterministic and Probabilistic Short-Term Reliability Management. In Proceedings of the 2018 IEEE Power & Energy Society General Meeting (PESGM), Portland, OR, USA, 5–10 August 2018; pp. 1–5. [[CrossRef](#)]
25. Edimu, M.; Gaunt, C.; Herman, R. Using probability distribution functions in reliability analyses. *Electr. Power Syst. Res.* **2010**, *81*, 915–921. [[CrossRef](#)]
26. Pan, J.; Wang, Z.; Lubkeman, D. Condition based failure rate modeling for electric network components. In Proceedings of the 2009 IEEE/PES Power Systems Conference and Exposition, Seattle, WA, USA, 15–18 March 2009; pp. 1–6.
27. Rubinstein, R.Y.; Kroese, D.P. *Simulation and the Monte Carlo Method*, 3rd ed.; John Wiley & Sons: Hoboken, NJ, USA, 2011; ISBN 9781118631980.
28. Hadjsaid, N.; Sabonnadière, J.C. *Electrical Distribution Networks*; John Wiley & Sons: Hoboken, NJ, USA, 2013.
29. Ilie, I.; Hernando-Gil, I.; Djokic, S.Z. Theoretical interruption model for reliability assessment of power supply systems. *IET Gener. Transm. Distrib.* **2014**, *8*, 670–681. [[CrossRef](#)]
30. IEEE Guide for Electric Power Distribution Reliability Indices. In *IEEE Std 1366–2012 (Revision of IEEE Std 1366–2003)*; IEEE: New York, NY, USA, 2012; pp. 1–43. [[CrossRef](#)]
31. Brown, R.E. *Electric Power Distribution Reliability*, 2nd ed.; CRC Press: New York, NY, USA, 2009; ISBN 978-8493-7567-5.
32. Moon, J.-F.; Kim, J.-C.; Lee, H.-T.; Lee, S.-S.; Yoon, Y.T.; Song, K.-B. Time-varying failure rate extraction in electric power distribution equipment. In Proceedings of the 2006 International Conference on Probabilistic Methods Applied to Power Systems, Stockholm, Sweden, 11–15 June 2006; pp. 1–6.
33. Sen, P.; Pansuwan, S. Overloading and loss-of-life assessment guidelines of oil-cooled transformers. In Proceedings of the 2001 Rural Electric Power Conference, Little Rock, AR, USA, 29 April–1 May 2001.
34. Fu, W.; McCalley, J.; Vittal, V. Risk assessment for transformer loading. *IEEE Trans. Power Syst.* **2001**, *16*, 346–353. [[CrossRef](#)]
35. Nadarahan, S.; Kotz, S. The beta-exponential distribution. *Reliab. Eng. Syst. Saf.* **2006**, *91*, 689–697. [[CrossRef](#)]
36. Hilber, P. Component Reliability Importance Indices for Maintenance Optimization of Electrical Networks. Master’s Thesis, The Royal Institute of Technology Stockholm, Stockholm, Sweden, 2005.
37. Majid, A.S.N.A.; Salim, N.A.; Mohamad, H.; Yasin, Z.M. Assessment of Expected Customer Interruption Cost Due to Power System Contingency by Sensitivity Analysis. In Proceedings of the 2020 IEEE International Conference on Power and Energy (PECon), Penang, Malaysia, 7–8 December 2020; pp. 171–175.
38. Küfeoğlu, S.; Lehtonen, M. A review on the theory of electric power reliability worth and customer interruption costs assessment techniques. In Proceedings of the 2016 13th International Conference on the European Energy Market (EEM), Porto, Portugal, 6–9 June 2016; pp. 1–6.
39. Chowdhury, A.A.; Koval, D.O. Value-based distribution system reliability planning. *IEEE Trans. Ind. Appl.* **1999**, *35*, 305–311. [[CrossRef](#)]
40. Quality of Service Guaranteed Standards. OFGEM. Available online: <https://www.ofgem.gov.uk/licences-codes-and-standards/standards/quality-service-guaranteed-standards> (accessed on 15 February 2021).
41. Allan, R.; Billinton, R.; Sjarief, I.; Goel, L.; So, K. A reliability test system for educational purposes-basic distribution system data and results. *IEEE Trans. Power Syst.* **1991**, *6*, 813–820. [[CrossRef](#)]
42. Hernando-Gil, I.; Hayes, B.; Collin, A.; Djokic, S. Distribution network equivalents for reliability analysis. Part 2: Storage and demand-side resources. In Proceedings of the IEEE PES ISGT Europe 2013, Lyngby, Denmark, 6–9 October 2013.

-
43. Collin, A.; Hernando-Gil, I.; Acosta, J.L.; Djokic, S.Z. An 11 kV steady state residential aggregate load model. Part 1: Aggregation methodology. In Proceedings of the 2011 IEEE Trondheim PowerTech, Trondheim, Norway, 19–23 June 2011; pp. 1–8. [[CrossRef](#)]
 44. Babu, S. *Reliability Evaluation of Distribution Systems; Considering Failure Modes and Network Configuration*; Ener-giforsk AB, KTH Royal Institute of Technology: Stockholm, Sweden, 2017.