



HAL
open science

DG Locational Incremental Contribution to Grid Supply Level

Ignacio Hernando-Gil, Zhipeng Zhang, Mike Brian Ndawula, Sasa Djokic

► **To cite this version:**

Ignacio Hernando-Gil, Zhipeng Zhang, Mike Brian Ndawula, Sasa Djokic. DG Locational Incremental Contribution to Grid Supply Level. IEEE Transactions on Industry Applications, 2021, pp.1-1. 10.1109/TIA.2021.3118337 . hal-03482366

HAL Id: hal-03482366

<https://hal.science/hal-03482366>

Submitted on 15 Dec 2021

HAL is a multi-disciplinary open access archive for the deposit and dissemination of scientific research documents, whether they are published or not. The documents may come from teaching and research institutions in France or abroad, or from public or private research centers.

L'archive ouverte pluridisciplinaire **HAL**, est destinée au dépôt et à la diffusion de documents scientifiques de niveau recherche, publiés ou non, émanant des établissements d'enseignement et de recherche français ou étrangers, des laboratoires publics ou privés.

DG Locational Incremental Contribution to Grid Supply Level

Ignacio Hernando-Gil, *Senior Member, IEEE*, Zhipeng Zhang, *Member, IEEE*, Mike Brian Ndawula, *Member, IEEE*, and Sasa Z. Djokic, *Senior Member, IEEE*

Abstract—Due to decarbonisation and decentralisation of energy sectors, the rise of distributed generation (DG) will modify generation and demand patterns at grid supply points (GSPs), where the interface between distribution and transmission systems takes place. With the increasing penetration of such devices, methodologies able to evaluate its contribution to both local distribution network and transmission system become crucial. This paper proposes an analytical method to evaluate the DG locational incremental contribution (LIC) to the interface with the transmission grid. Accordingly, the original model of the UK engineering recommendation P2 is enhanced by studying the impacts from high-voltage distribution networks (i.e. ≤ 132 kV) under normal and contingent conditions. This approach enables a more accurate network security assessment, especially when considering contingencies such as distribution system faults. To illustrate the proposed method, the original P2 model is compared against different enhanced approaches on three basic distribution networks, followed by a case study and a sensitivity analysis on a revised IEEE 14-bus GSP system. The proposed LIC method produces results that assess a wider range of conditions including DG penetration, concentration, and system reliability. Furthermore, it provides an increased DG visibility for transmission planning and operation.

Index Terms— distributed generation, power system reliability, network congestion management, network state enumeration, transmission system operator.

NOMENCLATURE

A. Indices and Sets

l	Circuit line
m	Component's down state
n	Component's up state
s	System state
T_m	Persistence time

B. Variables and Parameters

$P(s)$	Distribution system probabilities
U	Component's unavailability
U_m	Component's down state
U_n	Component's up state

λ	Component's failure rate (FR)
r	Component's mean time to repair (MTTR)
P_l	Circuit power flow
C_l	Circuit capacity limit
$\partial P_l / \partial P_{DG}$	Power transfer distribution factor
V_n	Bus voltage magnitude
θ_n	Bus phase angle
DG_N	Distributed generation unit
EC_N	Unit's effective capacity
DNC_N	Unit's declared net capacity
SF_N	Unit's scaling factor
NE_N	Unit's network effects
LIC_N	Unit's locational incremental contribution
PC	Power component

I. INTRODUCTION

THE evolution into zero-carbon economies is progressively introducing a large growth of renewable generation in the energy mix [1]. Due to size and location, renewable resources can contribute to distribution levels that vary from low to extra high-voltage levels [2]. The growing penetration of distributed generation (DG) is modifying generation and demand patterns at the interconnection between transmission and distribution systems, i.e. grid supply points (GSPs), which changes the way the transmission grid operates and increases the challenges of energy balancing, demand forecasting and constraint management. As one of the benefits from DG is reliability enhancement [3]-[6], the conventional GSP duty to satisfy system security and demand adequacy can now be shared by embedded DGs from distribution networks.

Considerable work was undertaken at power distribution levels to weigh the influence of DG to local network adequacy [7]-[12]. These studies have proposed methods to determine DG's ability to satisfy network's peak demand during normal operations. However, its relatively low and dispersed penetration at the current stage has led to limited studies on the impact of DG on transmission levels, particularly for the

I. Hernando-Gil is with ESTIA Institute of Technology, University of Bordeaux, Bidart 64210, France (e-mail: i.hernandogil@estia.fr).

Z. Zhang was with the Department of Electronic and Electrical Engineering, University of Bath, Bath BA2 7AY, U.K. (e-mail: z.zhang2@bath.ac.uk).

M. B. Ndawula is with the Department of Electronic and Electrical Engineering, University of Bath, Bath BA2 7AY, U.K. (e-mail: m.b.ndawula@bath.ac.uk).

S. Z. Djokic is with the Institute for Energy Systems, School of Engineering, University of Edinburgh, Edinburgh EH9 3JL, U.K. (e-mail: sasa.djokic@ed.ac.uk).

concerns of network security and reliability [13]-[15]. More importantly, as revealed in [16]-[18], no practical/reliable tools are available yet to accurately quantify DG's increasing effects to transmission networks. The security and quality of supply standards (SQSS) in Great Britain sets out criteria for the operation and planning of the power transmission grid [19]. Accordingly, it presents a purely deterministic approach to measure the influence of major DGs to securing the group demand in each case, specifically the inherent contribution time of different intermittent generation. Another approach to assessing DG input is the engineering recommendation ER P2, recently updated to P2/7 [20][21], which has been in place in the UK for more than 4 decades as a guide to distribution network operators (DNOs) and long-term planning [22]. Compared with the SQSS standards in [19], ER P2 dictates a more comprehensive direction on best ways to estimate DG security contribution, as it considers different characteristics of the examined DG such as generation availability or plant size.

Nevertheless, for the correct assessment of security contribution from DG technologies to the transmission grid specifically, the interconnection, i.e. the distribution network, cannot be neglected. Different transmission-level studies on DG have already recognised these distribution network-imposed constraints [23]-[26]. The challenges for the transmission system operator when assessing DGs are their embedded feature to various levels of distribution networks. Each DNO has detailed network models and operating strategies which make such embedded DGs difficult to visualise and predict from transmission levels. To solve the issue in e.g. [20], this paper proposes a practical and effective methodology to quantify DG's contribution to the grid supply point.

Moreover, distribution network status, which is derived from e.g. planned and unplanned outages, has a direct impact on DG's output and thus will reduce its ultimate contribution to the transmission grid. However, current standards on grid operation and network planning (SQSS [19] and P2/7 [20][21]) do not consider the distribution system's conditions in impacting DG contribution to transmission level. Existing assumptions of uninterrupted distribution circuits with infinite thermal capacities cannot reflect the real operating conditions and thus derive inaccurate results for transmission-level analysis [27]-[30]. All these issues will become highly consequential with the increasing penetration of DGs in the foreseeable future.

Based on the limitations from current standards on grid operation and network planning in the UK (SQSS [19] and ER P2/7 [20][21]), this paper proposes an enhanced method to evaluate the DG locational incremental contribution (LIC) to the interface with the transmission grid. Improved from the original ER P2 model, this approach considers the control of DG output imposed by distribution network conditions and seeks to quantify the expected curtailments and effective DG capacity due to e.g. network contingency conditions such as thermal overloading or faults. Compared with existing industrial methods, the obtained results provide an overview of different scenarios for DG location, as well as for network indices such as loading level and DG penetration, enabling an easier assessment of DG network planning.

II. METHODOLOGY

The work in this paper is demonstrated and compared with the original ER P2 model [20] on three simple distribution network topologies, providing step-by-step quantitative figures to describe the proposed mathematical model development. In addition, an extended version of the IEEE 14-bus GSP test system is further analysed to prove the adaptability of the proposed method to more complex and realistic networks.

A. DG Effective Capacity

The influence of DG technologies to transmission network primarily depends on the generation profile of such DG units. As compared to conventional power plants, DGs exhibit different characteristics due to the intermittent power output coming from renewable resources such as solar, wind or hydro. This effectively makes the power profile from DG extremely difficult to predict. Moreover, as DGs are usually non-centrally dispatched by utilities, but privately owned, the option to run these generations is normally altered by commercial incentives and market conditions. Due to these reasons, a comprehensive modelling of DG effective capacity is needed to reflect the technical, energy and commercial availabilities of each studied DG. As depicted by equation (1), the UK standard ER P2 [20] introduces a concept of 'effective capacity' (EC) to compute the effective contribution of different DG technologies under intermittent outputs. Following the data model provided in ER P2, the 'effective capacity' EC of a particular DG_N can be estimated by multiplying its declared net capacity (DNC) with the corresponding scaling factor (SF) of each DG:

$$EC_N = DNC_N \cdot SF_N \quad (1)$$

Derived from real DG data spreading throughout the UK [31], the scaling factors SF which are provided in the standard ER P2 (and shown in Table I and II) indicate how much % of the 'declared net capacity' DNC can be considered as effective [21]. At the same time, the calculation approach for the DNC must distinguish between non-intermittent and intermittent DG type. As per Table I and II [20], for non-intermittent DGs, the resulting 'effective capacities' depend on the particular DG category and on the number of connected DG systems; while for intermittent DGs the input figures given by ER P2 [20] are subject to DG type and persistence time. The latter factor represents the duration in time for which the intermittent DG must be continuously available (minimum) to be considered as contributory [20]. Compared to non-intermittent, the lower effective capacities of wind, hydro and solar generation due to intermittent energy availabilities have been reflected in Table I and II. If e.g. a simple GSP network is connected with a 4-unit (2 MW) landfill gas generation and a wind farm (35 MW) with a persistence time of 0.5h, the effective contribution EC_N of each DG_N (according to ER P2) can be calculated as the product of the declared net capacity DNC_N and the scaling factor SF_N :

$$EC_{Landfill} = 4 \times 2 \times 75\% = 6 \text{ MW}$$

$$EC_{Wind} = 35 \times 28\% = 9.8 \text{ MW}$$

Hence, for multiple DGs connected in a specific network, the effective capacity of each DG can be derived alone.

TABLE I. SCALING FACTORS IN % FOR NON-INTERMITTENT DG [20]

Technology of DG	Number of DG systems connected									
	1	2	3	4	5	6	7	8	9	10+
Landfill Gas	63	69	73	75	77	78	79	79	80	80
CHP ignition	40	48	51	52	53	54	55	55	56	56
Waste-energy	58	64	69	71	73	74	75	75	76	77
CCGT	63	69	73	75	77	78	79	79	80	80
CHP gas	53	61	65	67	69	70	71	71	72	73

TABLE II. SCALING FACTORS IN % FOR INTERMITTENT DG [20]

Technology of DG	Persistence, T_m (hours)							
	0.5	2	3	18	24	120	360	>360
Wind farm	28	25	24	14	11	0	0	0
Small hydro	37	36	36	34	34	25	13	0
Solar (summer)	12	11	10	2	0	0	0	0
Solar (winter)	0	0	0	0	0	0	0	0

* Note [20] - Solar (summer): values for $T_m > 18$ set to zero as Solar cannot contribute to security overnight. Solar (winter) - values set to zero as Solar cannot contribute to security if demand peak is after dusk.

B. Network Effects

The impact of interconnection networks has not been considered yet. Distribution networks in-between a DG system and the grid supply point *GSP* have a high influence on the DG-contribution to the transmission network, especially for high DG penetration via a relatively weak network [27]. Conditions like distribution network congestion or fault are likely to constrain DG's output, requiring a curtailment of that output by DNOs to relieve network congestion [32]-[35]. Consequently, a discounted DG contribution is seen by the transmission grid.

For the example test case in Fig. 1, the DG system under analysis and the load demand have the same connection (i.e. network bus) before the GSP. In this case, the DG unit presents an effective capacity *EC* of e.g. 10 MW and the total load is 2 MW. After supplying the 2 MW local demand, which otherwise must be supplied by the GSP, the rest of DG power (8 MW) will flow upstream to the transmission grid through the GSP. Thus, the DG-incurred benefit seen from the transmission system contains two parts, i.e. contribution = 2 MW + 8 MW = 10 MW, which is exactly the effective capacity of the DG.

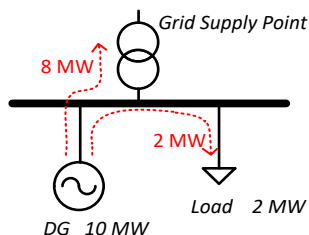

Fig. 1. DG influence with no interconnection considered.

Distribution network losses are neglected for simplification purposes. Instead, in the case of Fig. 2, both the load point and DG system have a connection to GSP via a paralleled double circuit. After meeting local demand, the power that can be delivered to the GSP depends on the nominal capacity as well as on the pre/post fault circuit condition. In Fig. 2(a), the maximum loading (i.e. total capacity) of the double circuit is

less than 8 MW as before, where a single circuit now has a thermal rating of e.g. 2 MW. The original 8 MW dispatch as in Fig. 1 would apparently cause congestions. Therefore, the generation in this case must be curtailed to 6 MW to comply with network constraints. Fig. 2(b) introduces the grid effect of contingent events. When a single circuit trips, to avoid thermal overload on the parallel circuit, the power from the DG should be further constrained to 4 MW (2 MW + 2 MW), which is 6 MW less than the intrinsic capability of the DG, assuming no short-term ratings are available following the system fault.

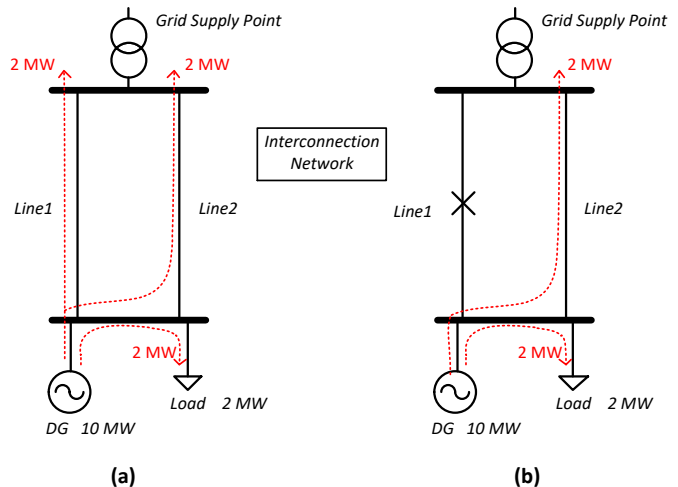

Fig. 2. DG influence with network connection. (a) Normal state. (b) Contingency state.

Accordingly, to quantify the network effects on DG curtailment within a more complex and realistic system, the network state enumeration method is proposed through:

1) Enumerating the mutually exclusive states (*s*) and probabilities $P(s)$ of the distribution system under analysis, which considers the different combination of 'up' and 'down' states of every single power component (PC) in the network;

$$P(s) = \prod_m U_m \prod_n (1 - U_n) \quad (2)$$

$$U = \frac{\lambda}{\lambda + 1/r} \quad (3)$$

where, *m* and *n* respectively represent the components with 'down' and 'up' states for each system state *s*; *U* is the component's unavailability; λ and *r* characterise the failure rate (FR) and mean time to repair (MTTR) which are expected from each network component (e.g. Table VII).

2) Evaluating DG curtailment for specific network states;

The approach to manage DG system contribution currently followed by UK DNOs lies on a 'last-on-first-off' (LOFO) criterion [34][35]. In case of a circuit overload, the latest DG units connected to the grid should be off-controlled or capped in the first instance. However, there are situations when the last-on DG unit is less effective to clear overload, but more expensive to be constrained, thus the 'last-on-first-off' criterion does not seem economically viable. To increase efficiency, the

method developed in this paper uses a power flow sensitivity model. The power transfer distribution factor (PTDF), i.e. $\partial P_i / \partial P_{DG}$ in (4), is a sensitivity matrix that specifies the input from each nodal power injection to a circuit. In the case of overloading events in distribution networks, the PTDF quantifies each DG's effectiveness to contribute to an overloaded circuit, as it computes the DG's contribution to the different nodal power congestions. According to the PTDF, the most effective DG with the highest influence on the circuit overload is thus chosen for curtailment, which is calculated by:

$$Curtailment = \frac{P_l - C_l}{\partial P_l / \partial P_{DG}} \quad (4)$$

where, P_l is the power flow on the overloaded circuit before curtailment; C_l is the power capacity limit of the circuit; and $\partial P_l / \partial P_{DG}$ is the PTDF of the overloaded circuit with respect to the selected DG. Under network state s , the cumulative generation curtailment is given by (5) to alleviate the overloading on every circuit l .

$$Curtailment_{N,s} = \sum_l Curtailment_{N,s}^l \quad (5)$$

3) Calculating network effects;

Finally, the estimated network effects on a particular DG_N , under network state s , are calculated by adding up the generation curtailment and their corresponding availability probabilities $P(s)$ on the selected DGs:

$$NE_N = \sum_s (P(s) \cdot Curtailment_{N,s}) \quad (6)$$

C. Locational Incremental Contribution

Based on the previously calculated variables, The *LIC* to a transmission grid supply point is calculated in this paper by considering both the effective capacity EC_N and the network effects NE_N on the power output of the DG_N under analysis:

$$LIC_N = EC_N - NE_N \quad (7)$$

The difference in equation (7), i.e. the LIC_N , represents the incremental impact on the GSP interface from a particular DG unit (measured in MW) for the correct planning and assessment, other than the model from standard ER P2 [20], of network security, reliability and DG penetration.

Mathematically, the aggregated thermal violation in the network incurring on DG output curtailment can be calculated by the following approach:

1) Sensitivity of Component Power Flow to DG Injection;

Since the DG integration might change the condition of the network power allocation and flow direction, the power flow and utilisation level of each component directly depends on the current network DG connection. Specifically, the effect of DG injection $P_{DG,n}$ (i.e. effective capacity EC_N) on the active power flow along a circuit l between nodes i and j can be obtained by:

$$\frac{\partial P_{ij}}{\partial P_{DG,n}} = \frac{\partial P_{ij}}{\partial V_i} \frac{\partial V_i}{\partial P_{DG,n}} + \frac{\partial P_{ij}}{\partial V_j} \frac{\partial V_j}{\partial P_{DG,n}} + \frac{\partial P_{ij}}{\partial \theta_i} \frac{\partial \theta_i}{\partial P_{DG,n}} + \frac{\partial P_{ij}}{\partial \theta_j} \frac{\partial \theta_j}{\partial P_{DG,n}} \quad (8)$$

Where, P_{ij} is the active power flow between points i and j ; V_i , V_j , θ_i and θ_j are respectively the voltage magnitudes and bus angles of nodes i, j . Fig. 3 shows the algorithm framework and modelling of the computational process proposed in this paper.

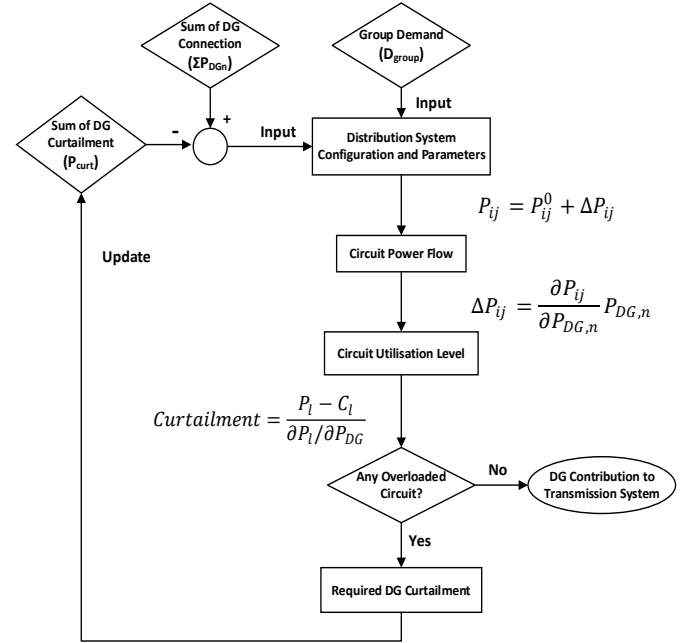

Fig. 3. Mathematical model of DG contribution to transmission system.

III. DEMONSTRATION OF THE LIC APPROACH

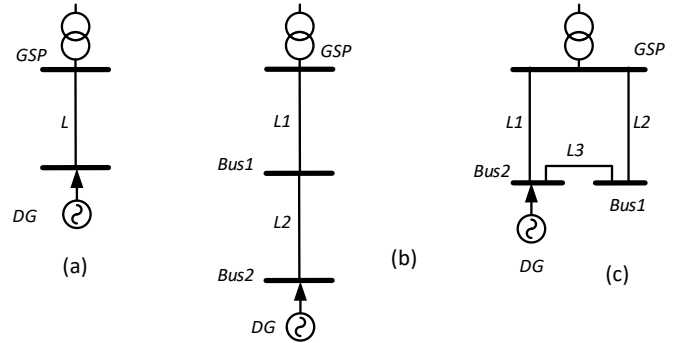

Fig. 4. Single circuit, double circuit, and meshed test systems.

A. Single Circuit Network

The proposed method is firstly tested on a basic network, as presented in Fig. 4(a). In this case, the circuit L connecting the grid supply point GSP and the DG units has a power rating of e.g. 100 MW and an unavailability of 0.01. The aggregated DG units are composed of e.g. 10-unit landfill gas and a total declared net capacity DNC of 100 MW. Based on Table I [20] and the states enumeration calculated by equation (2) in Table III, the *LIC* calculation is described below, where the modelling of the network effects NE on the examined DG involves enumerating all mutually exclusive states of the network:

$$EC = 100 * 80\% = 80 \text{ MW} \quad \text{eq. (1)}$$

$$NE = 0 * 99\% + 80 * 1\% = 0.8 \text{ MW} \quad \text{eq. (6)}$$

$$LIC = EC - NE = 80 - 0.8 = 79.2 \text{ MW} \quad \text{eq. (7)}$$

TABLE III. STATE ENUMERATION FOR SINGLE-CIRCUIT NETWORK

Number	Network state	DG curtailment	Probability
1	L Up	0 MW	99%
2	L Down	80 MW	1%

B. Double-length Circuit Network

Fig. 4(b) assumes both circuits $L1$ and $L2$ with 100 MW rating, while the connection of DG systems at bus 2 still comes from landfill gas. From Table IV and eq. (2), LIC is calculated:

$$NE = 80 * 1.98\% + 80 * 0.01\% = 1.6MW \quad eq. (6)$$

$$LIC = 80 - 1.6 = 78.4 MW \quad eq. (7)$$

In this case, the DG located at bus 2 is supported by a double-length circuit and thus uses the network more extensively as compared with the single-circuit network. Therefore, when the DG unit is connected through an extended network at a farther distance to the grid supply point GSP , the probability of power transfer disruptions is higher. This will result in a higher value for the network effects NE , and hence its locational contribution will decrease.

TABLE IV. STATE ENUMERATION FOR DOUBLE-CIRCUIT NETWORK

Number	Network state	DG curtailment	Probability
1	L1, L2 Up	0 MW	98.01%
2, 3	N-1	80 MW	1.98%
4	N-2	80 MW	0.01%

C. Meshed Network

The proposed LIC evaluation approach can be extended to reflect the security level of the connecting network between an examined DG and its supplying node. By comparison with the single-circuit network, in the meshed network depicted in Fig. 4(c) the DG-connected bus is supported by two paths, so if any of the three circuits fails, the DG output could still be transferred through the remaining circuits; hence withstanding N-1 contingencies in the connecting network. In Fig. 4(c) the meshed network contains the circuits $L1$, $L2$, $L3$, each rated at 100MW. Busbar 2 supports the connection of the same type of DG. From Table V and eq. (2), the calculated LIC is as follows:

$$NE = 80 * 0.0099\% + 80 * 0.0099\% + 80 * 0.0001\% = 0.02MW$$

$$LIC = 80 - 0.02 = 79.98 MW$$

TABLE V. STATE ENUMERATION FOR MESHED NETWORK

Number	Network state	DG curtailment	Probability
1	L1 out of service	0 MW	0.9801%
2	L2 oos	0 MW	0.9801%
3	L3 oos	0 MW	0.9801%
4	L1, L2 oos	80 MW	0.0099%
5	L1, L3 oos	80 MW	0.0099%
6	L2, L3 oos	0 MW	0.0099%
7	L1, L2, L3 oos	80 MW	0.0001%

D. Comparison of Results

The DG-contribution results for the three basic networks have been summarised and cross-related with the standard ER

P2 model [20] in Table VI. Accordingly, as proven by the power mismatch (MW) between the two methods, the proposed model in this paper enables to evaluate (more accurately than the ER P2 standard) the effect of different grid configurations on the contribution of DG systems to a network's grid supply point. A higher level of connecting network security (c) dictates that the expected magnitude of network effects on the integrated DG becomes considerably minimal, and thus will facilitate a higher contribution level from DG to transmission-level.

TABLE VI. DG CONTRIBUTION & COMPARISON WITH ER P2 MODEL [20]

	By original P2/6 (MW)	By proposed approach (MW)	Mismatch (MW)
Case A	80	79.2	0.8
Case B	80	78.4	1.6
Case C	80	79.98	0.02

IV. LIC APPROACH TO ASSESS DG CONTRIBUTION FROM DISTRIBUTION NETWORKS

The DG contribution approach is further demonstrated and cross-related with the standard ER P2 on a 14-bus distribution network, as shown in Fig. 5 [36]. In this study, the grid supply point GSP to the transmission grid which supplies a voltage of 400/132 kV is assigned to busbar 1. The rest of busbars in the system provide a rating of 132 kV (i.e. buses 1-5) and 33 kV (i.e. buses 6-14). Accordingly, branch specifications of the test system and the adopted values of components' MTTR and failure rates are provided in Tables VII and VIII respectively [37]. In this part, the network maximum demand (259 MW) will be used to compute DG contribution to GSP , where most of the network demand is jointly connected at 132 kV (buses 2 and 3).

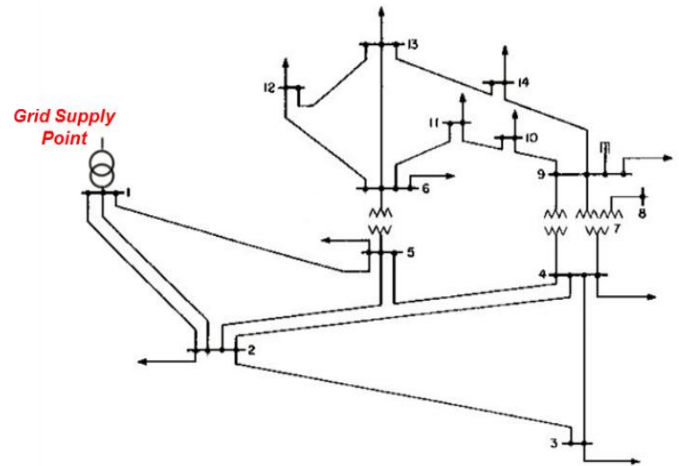

Fig. 5. 14-bus GSP test system [36].

TABLE VII. POWER COMPONENT'S MTTR AND FAILURE RATES [37]

Network Component	Voltage Level (kV)	FR- λ (failures/km-year or failures/PC-year)	MTTR (hrs)
Overhead Lines	132	0.0038	19.1
	33	0.034	20.5
Cables	132	0.0277	222.7
	33	0.034	338.4
Transformers	132/33	0.0392	250.1

TABLE VIII. BRANCH SPECIFICATIONS FOR THE GSP TEST SYSTEM [37]

Branch No.	From bus – To bus	Thermal Rating (MVA)	Length (km)
1	1-2	260	28.47
2	1-5	260	93.8
3	2-3	125.7	82
4	2-4	83.3	67
5	2-5	97.1	65
6	3-4	98	71
7	4-5	151.4	18
8	4-7	45	-
9	4-9	60	-
10	5-6	90	-
11	6-11	25	7
12	6-12	22	9.5
13	6-13	28	4.2
14	7-8	20.5	5.67
15	7-9	33.5	-
16	9-10	32.6	2.7
17	9-14	34.3	7.64
18	10-11	23	5.6
19	12-13	14	6.2
20	13-14	18	10.5

A. DG Locational Incremental Contribution to GSP

The base case considers 5 DG units of the landfill gas type, with connection at buses 10, 11, 12, 13 and 14 respectively, each having an effective capacity EC of 32 MW. For investigating the DG locational contribution at different nodes, an additional single landfill gas generator (here refers as examined DG) is connected at each dedicated node in the test system at 132 kV (e.g. buses 1, 3, 6, 8) and 33 kV (buses 10, 11, 12, 13, 14) with a declared net capacity DNC of 50 MW and an EC of 40 MW (with a scaling factor SF = 0.8).

The derived network effects NE and 'locational incremental contribution' LIC values for the examined DG after connection to different nodes are shown in Fig. 6. According to the ER P2 model [20], the DG effective capacity EC for each bus (40 MW) remains the same for all nodes. Moreover, the nodal location of DG has an important effect on the overall contribution to the grid supply point. For DGs electrically close to the GSP (e.g. buses 1, 3 or 6 at higher voltage level) the impact from network effects are negligible, as shown by the minimal NE values resulting at those buses. In that case, the locational influence from DG results in similar EC values as those given by ER P2.

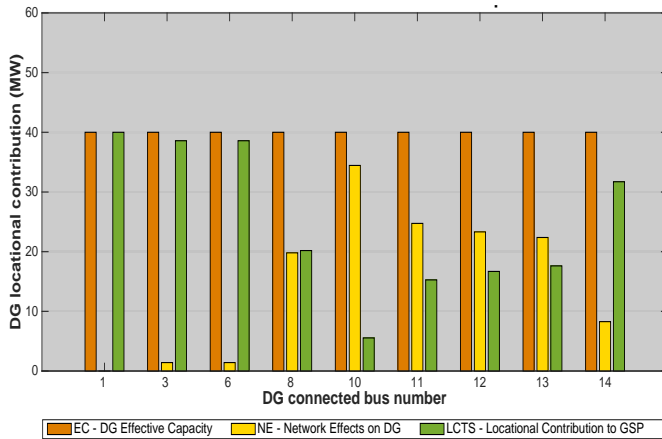

Fig. 6. DG locational contribution and decomposition at different buses.

However, as shown in Fig. 6, when the aggregated DG unit is connected at the remote end (e.g. buses from 8 to 14 at lower voltage level), the network effect is important. In the case of e.g. buses 10 and 11, the distribution system impact discounts more than half of the DG effective capacity estimated by the original ER P2. The results show the proposed LIC method can distinguish and evaluate the distribution system impact and location on DG contributions to a transmission GSP, as compared with the limitations in the original ER P2 model [20].

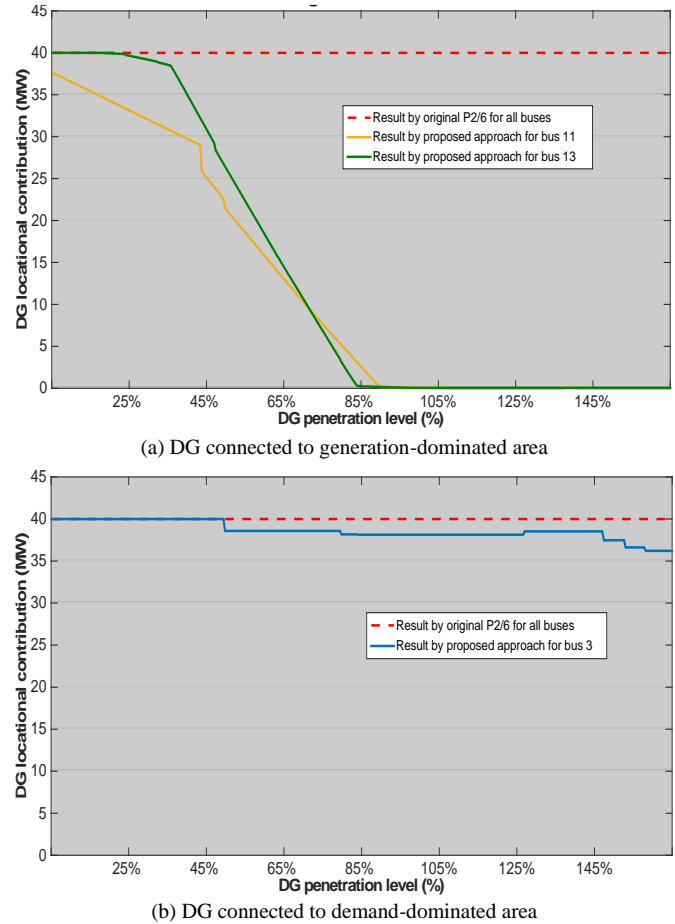

Fig. 7. DG penetration impact on MW locational contribution.

B. Network Effect of DG Penetration Level on LIC

Another advantage of the proposed LIC method is the ability to reflect the nodal DG contribution considering the overall DG penetration in the network. Based on the system's peak demand (259 MW), the DG penetration level in the base case is set at:

$$Penetration (\%) = \frac{32MW \times 5}{259MW} = 62\%$$

Therefore, to test various DG penetration levels, the capacities of the 5 existing DGs connected at buses 10-14 in the network are increased and decreased accordingly. The examined DG for LIC calculation at each dedicated node is equal to the one used in the previous case (DNC = 50 MW and EC = 40 MW). Fig. 7 shows the comparison between the method in this paper and the standard ER P2 for the evaluation of diverse DG penetration scenarios in two of the examined buses (e.g. 11 and 13). Thus, it is noticed that the original ER

P2/6 cannot reflect the sensitivity of nodal LIC change with respect to the penetration of embedded generation, as it overestimates and remains constant for all cases. On the contrary, the proposed LIC method provides a more realistic estimation of DG penetration, as it can accurately differentiate among scenarios with lower DG levels, i.e. resulting in higher locational contributions, while high penetration situations lead to a significantly lower impact.

C. Impact of Generation-dominated and Demand-dominated Areas on LIC

The proposed model is also characterised by its ability to discriminate DGs connected to generation-dominated areas from those connected to demand-dominated areas. As most of the network's demand in the 14-bus system is concentrated at buses 2 and 3, while the network-integrated landfill gas generations are linked to the lower-voltage buses 10 to 14, the upper and lower half of the network in Fig. 5 could be regarded as generation- and demand-dominated respectively.

As per Fig. 7(a), when the 'examined DG' is connected in the generation-dominated area (upper half), the resulting DG locational contribution of the examined unit (e.g. at buses 11 and 13) is rather sensitive to the effect of DG penetration. On the contrary, higher DG penetration levels seem to have a partial or limited effect on the locational contribution to the demand-dominated area (lower half), as shown in Fig. 7(b).

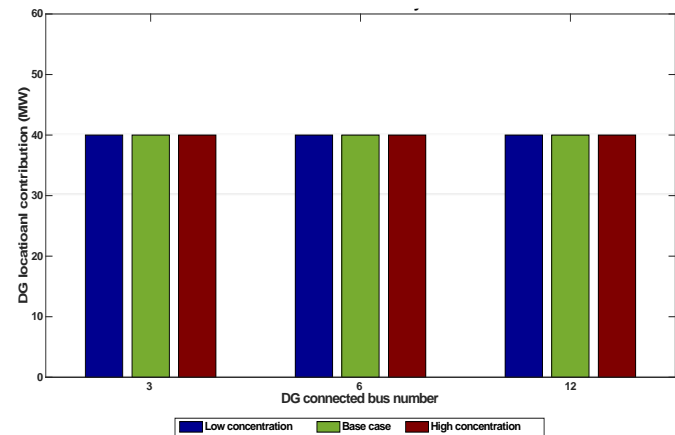

(a) Non-intermittent DG by ER P2/6 model

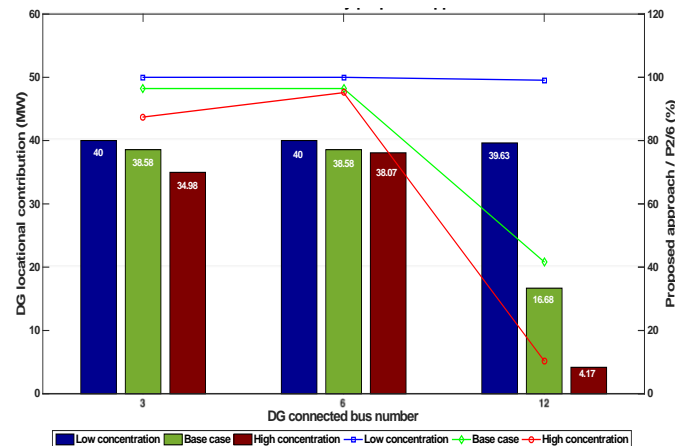

(b) Non-intermittent DG by proposed LIC method

Fig. 8. Impact of non-intermittent DG concentration on LIC to GSP.

In the demand-dominated situation, the DG generation can be locally consumed by adjacent demand, thus any network contingency or circuit overloading might have a limited impact. In a generation-dominated area, the locational DG output must travel through significant number of networks to reach load centres or the GSP. Thus, any contingency or circuit outage on the relevant network might directly affect the DG output.

D. Effect of DG Locational Density on LIC

In reality, opposite to the assumptions in the previous analysis (i.e. 5 existing DGs connected in the generation-dominated area at buses 10-14), the aggregated DG units could also be spread into wider areas of the network, or concentrated into small density areas due to flexible connection agreements.

Accordingly, in the following analysis three different DG locational density scenarios are studied: low-concentration, base case, and high-concentration. To introduce a lower-than-the-base-case DG density in the test network (i.e. more widely spread) the existing 5 DGs are connected to buses 2, 4, 6, 9 and 13, which covers a wider area of the analysed system. While for the high-DG density scenario, the DGs are concentrated in a relatively small area connected at busbars 12 and 13 only.

The same type of DG, a 50 MW landfill gas in the category of non-intermittent generation, is used to calculate the DG LIC at distinctive network locations (buses 3, 6, 12) under different DG density scenarios in the system, as shown in Fig. 8.

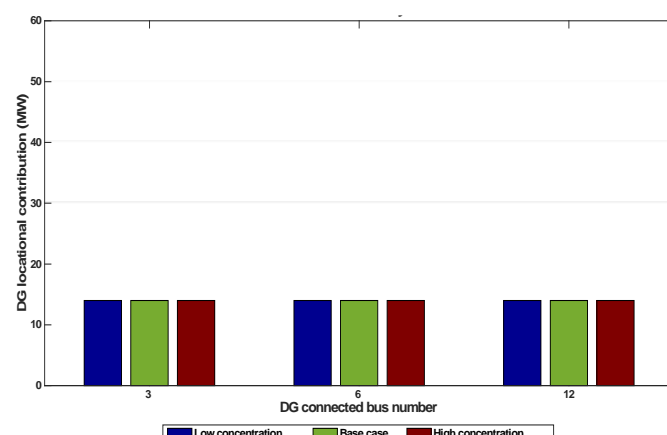

(a) Intermittent DG by ER P2/6 model

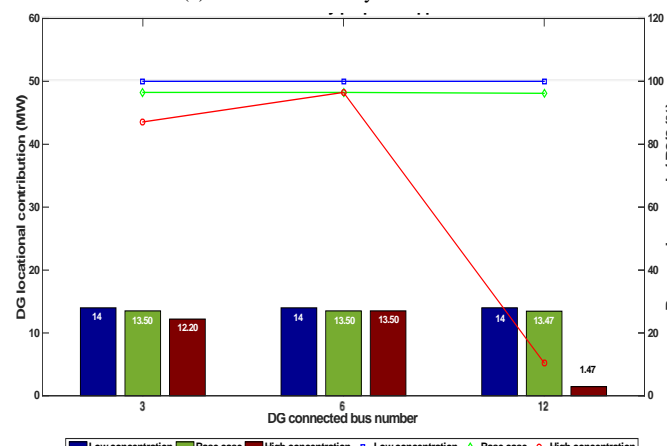

(b) Intermittent DG by proposed LIC method

Fig. 9. Impact of intermittent DG concentration on LIC to the GSP.

It can be observed that besides the incapability to provide locational results, the standard ER P2 [20] cannot distinguish between different network DG concentration conditions. In this case, i.e. Fig. 8(a), it would provide an identical contribution value (40 MW) under all three circumstances for the examined locational landfill gas. On the contrary, for these three buses in Fig. 8(b), the network containing more concentrated DGs clearly reduces the locational contribution from DG to the transmission grid. Moreover, it is noticeable that the impact of DG density is more significant for DG units locally connected to a generation-dominated area, as it is the case for bus 12 in Fig. 8(b). Specifically, in a high DG density scenario, e.g. bus 12 that falls into a generation-dominated area, its locational contribution LIC is less than 10%, as compared to the low DG density case (~100% LIC) or even the base case (~40% LIC).

On the other hand, the influence of DG density on the network intermittent generation has been assessed in Fig. 9, providing a similar pattern in the results; a larger impact from DG density to generation-dominated areas (e.g. bus 12). In this case, the locational DG under analysis represents a wind farm with the same declared net capacity DNC of 50 MW and a persistence time T_m of 0.5h. The main difference lies in a much smaller effective capacity, i.e. 14 MW, as calculated by eq. (1) and the scaling factor (28%) provided in Table II.

As compared with the standard ER P2 model [20], the proposed enhanced method can evaluate different DG concentration conditions at each network bus, as well as it can reflect the corresponding variances in results. This method demonstrates that for DGs with the same DNC, the locational contribution LIC of intermittent generation develops a less sensitive variation than for non-intermittent DGs (as shown in Fig. 8). This effect is due to the current density of DG in the system, corresponding to a lower value of effective capacities.

E. Influence of Network Loading Level

In all previous cases, the total system demand is fixed at 259MW. However, in real time operation the network loading varies significantly due to weather and seasonal effects. To account for these changes, and from the perspective of long-term power system planning (no real-time operation), in this section the loading level at each network node is both scaled up (by 20%) and down (by 20%) to quantify the overall effect of network demand levels on the DG locational contribution to the adequacy and security of the transmission GSP. Fig. 10 shows the simulation results representing the utilisation level of each network branch under the base case loading level (a), from which the cases (b) high loading level (+20%) and (c) low system loading level (-20%) are calculated. The increased values of local demand seem to have a direct correlation with higher values of circuit utilisation. Based on the traditional downward direction of power flows through the circuits of distribution networks, this greater utilisation is considered beneficial for the power output exports of locational DGs.

Table IX summarises the resulting values of DG locational contribution to each node under the three loading levels, i.e. low loading level indicates the system demand is scaled down by 20%, while high loading level means a scale up by 20%.

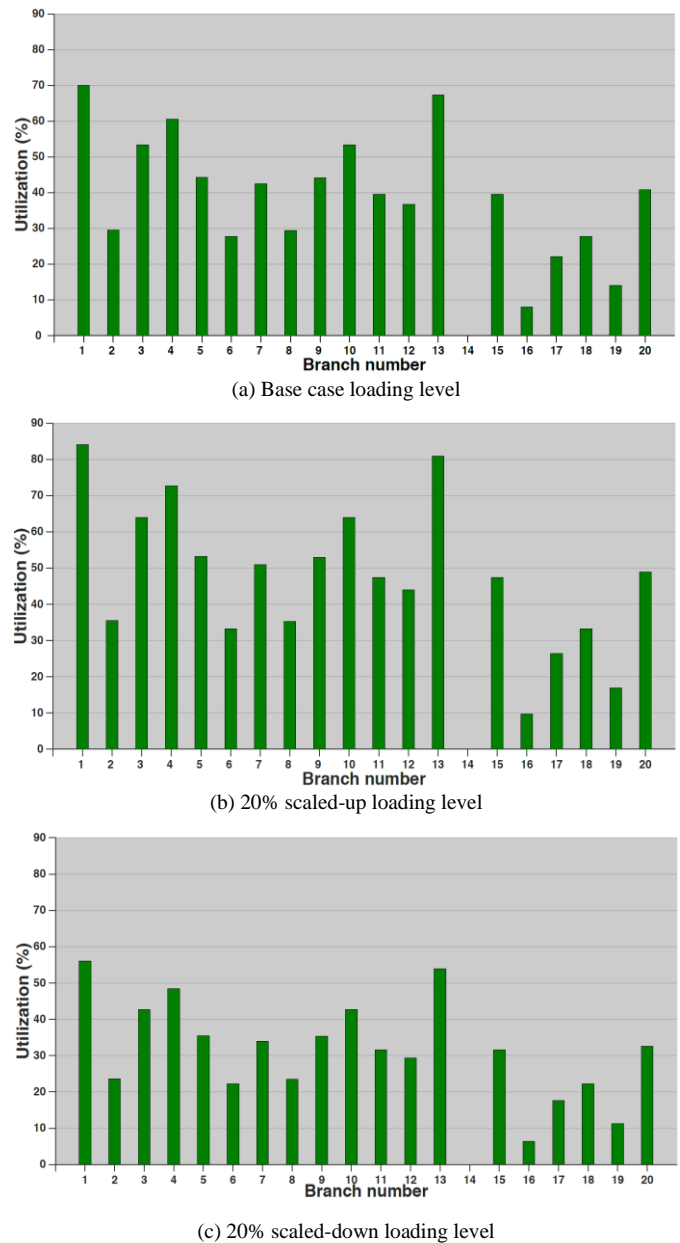

Fig. 10. Branch utilisation under varying loading (14-bus GSP test system).

It is seen from results in Table IX that higher loading levels (high LL) are generally linked to a higher DG contribution (LIC) in the network, especially in generation-dominated areas such as buses 10-14. This effect can be explained by the fact that larger DG outputs are locally consumed in scenarios with high locational demand, which avoids the reverse supply via the distribution network to the transmission GSP and thus resolves system contingencies. As an exception, for locational DG at bus 11, larger demand levels are otherwise linked to a lower DG contribution (LIC) as compared with the 'low' and 'base' loading level cases. This effect may be due to the power transfer distribution factor (PTDF) sensitivity on that specific bus.

Analogous deductions can be obtained from Table IX for the cross-relation of location and DG penetration. For a 46% penetration (e.g.), in demand-dominated areas (nodes 1-9) high loading level will generally result in lower LIC values, while in generation-dominated areas (nodes 10-14) high loading level

will result in higher LIC. Meanwhile, in a 77% penetration (e.g.) scenario, for nearly all nodes a high loading level will result in a higher LIC. Regarding the location of DG units, the result again proves the proposed model can differentiate between demand- and generation-dominated DG cases. Even though the DG contribution in demand-dominated areas (nodes 1-9) is also sensitive to network loading levels and DG penetration, this impact is limited, as shown in the upper section of Table IX (buses 1-9): in the case of the 50 MW locational landfill gas, the resulting DG outputs are close to 40 MW (its inherent effective capacity) for all network conditions, which represents the single case where the proposed LIC approach provides similar results to the non-flexible model of the standard ER P2. Conversely, the DG influence on generation-dominated areas becomes significant and can be accurately assessed by the proposed LIC model in Table IX, as opposed to the fixed results (i.e. 40 MW) that would be proposed by the ER P2 guideline for all range of network conditions.

TABLE IX. LIC VARIANCE (MW) WITH DIVERSE LOADING LEVELS (LL)

Bus No.	46% Penetration			77% Penetration		
	Low LL	Base case	High LL	Low LL	Base case	High LL
1	40	40	40	40	40	40
2	40	40	39.93	38.13	38.58	38.49
3	40	40	40	38.13	38.58	38.58
4	40	40	39.93	38.13	38.58	38.51
5	40	40	39.93	38.13	38.58	38.51
6	40	40	39.93	37.13	38.15	38.51
7	40	40	39.93	38.11	38.57	38.51
8	20.92	20.92	20.88	19.96	20.19	20.15
9	40	40	39.93	38.08	38.56	38.49
10	15.03	15.78	16.51	0.58	0.62	0.65
11	28.63	25.15	25.73	9.07	6.67	4.29
12	37.40	37.69	38.54	5.12	7.93	10.65
13	24.75	30.90	36.58	0.26	5.41	10.68
14	38.39	38.71	38.91	24.96	26.15	25.73

V. CONCLUSIONS AND FURTHER WORK

DG penetration in distribution networks will become sufficiently high in the near future. Accordingly, such dispersed resources will have the capability to feed power back to the transmission systems and thus contribute to the adequacy and security at the GSP level. From the perspective of power system planning, what is of interest and importance is a reliable quantification of such contributions.

This paper proposes an efficient method to analyse and quantify the DG's locational incremental contribution (LIC) to the grid supply point (GSP) of the transmission grid. Taking the standard ER P2 guidance as reference [20]-[21], the proposed method makes further improvement by considering both DG effective capacity and distribution system effect when assessing DG contributions. The model respects and differentiates between different conditions of DG penetration, concentration, location, and system loading level. The presented analysis leads to the following conclusions:

- 1) The enhanced method quantifies the effects of distribution system configuration on DG's contribution to transmission levels. For DGs connected within long electrical distance from the GSP via a relatively isolated and unreliable network, the proposed LIC method (as opposed to standard ER P2) proves that such circuit should be linked to a reduction of DG contribution to the GSP. Instead, only for DGs supported by an interconnected and reliable network, the contribution results produced by the proposed LIC method are closer to the 'fixed' DG's effective capacity given by the ER P2 guidance.
- 2) The proposed model reveals the amount of network DG penetration through the impact of DG's LIC to the GSP. An increased DG penetration in the overall system will reduce the single DG's LIC to the GSP. A higher system demand also reduces the influence of DG's LIC to the transmission grid, which is the result of the local energy consumption.
- 3) The proposed method is also able to accurately evaluate the DG's LIC in between generation and demand areas. Compared with demand-dominated areas, the contribution of DGs connected to generation-dominated areas is larger, as well as highly variable with respect to the DG penetration and the system loading level.
- 4) There exists a considerable effect from the degree of DG penetration on both intermittent and non-intermittent DGs, although non-intermittent units respond more easily, as demonstrated in Fig. 7. For cases with large DG concentration (i.e. generation-dominated areas), the study could result in values considerably different, e.g. 80% lower in Fig. 7(a), from those suggested by standard ER P2. Accordingly, DGs connected to demand-dominated areas present a lower dependence on this factor, as shown in Fig. 7(b).

Based on the contribution from the proposed method to the comprehensive analysis of different DG penetration, concentration, location, and system loading level, further work by the authors [38][39] will integrate the proposed DG's LIC approach with Model Order Reduction, State Enumeration and Monte Carlo simulation techniques for an accurate reliability assessment of complex power distribution systems and the impacts associated with the integration of different low-carbon technologies and microgrids.

ACKNOWLEDGEMENT

The present paper is an extended and revised version of a preliminary conference paper [40] that was presented and included in the proceedings of IEEEIC / I&CPS Europe 2020.

REFERENCES

- [1] National Grid, Electricity Ten-Year Statement 2020 (ETYS), 2020.
- [2] N. Jenkins, R. Allan, P. Crossley, D. Kirschen and G. Strbac, *Embedded Generation*, London: The Institution of Engineering and Technology, 2000.
- [3] D. T. Wang, L. F. Ochoa and G. P. Harrison, "DG impact on investment deferral: network planning and security of supply," *IEEE Trans. Power Systems*, vol. 25, no. 2, pp. 1134-1141, May 2010.
- [4] N. Jenkins, R. Allan, P. Crossley, D. Kirschen, and G. Strbac, *Embedded Generation*. London: The Institution of Engineering and Technology, 2000.
- [5] S.C. Vegunta, C.F.A. Watts, S.Z. Djokic, J.V. Milanović and M.J. Higginson, "Review of GB electricity distribution system's electricity security of supply, reliability and power quality in meeting UK industrial strategy requirements," *IET Gen. Trans. Dist.*, 13: 3513-3523, 2019.

- [6] G. Strbac, D. Kirschen and R. Moreno, "Reliability Standards for the Operation and Planning of Future Electricity Networks," now, 2016.
- [7] C. J. Dent, A. Hernandez-Ortiz, S. R. Blake, D. Miller and D. Roberts, "Defining and Evaluating the Capacity Value of Distributed Generation," in *IEEE Transactions on Power Systems*, vol. 30, no. 5, pp. 2329-2337, Sept. 2015, doi: 10.1109/TPWRS.2014.2363142.
- [8] D. Fang et al., "Deterministic and Probabilistic Assessment of Distribution Network Hosting Capacity for Wind-Based Renewable Generation," *2020 International Conference on Probabilistic Methods Applied to Power Systems (PMAPS)*, 2020, pp. 1-6.
- [9] Y. M. Atwa, E. F. El-Saadany, M. M. A. Salama, R. Seethapathy, M. Assam and S. Conti, "Adequacy evaluation of distribution system including wind/solar DG during different modes of operation," *IEEE Trans. Power Systems*, vol. 26, no. 4, Nov. 2011.
- [10] Y. M. Atwa, E. F. El-Saadany and A. C. Guise, "Supply adequacy assessment of distribution system including wind-based DG during different modes of operation," *IEEE Trans. Power Systems*, vol. 25, no. 1, pp. 78-86, Feb. 2010.
- [11] G. R. Pudaruth and F. Li, "Locational capacity credit evaluation," *IEEE Trans. Power System*, vol. 24, no. 2, pp. 1072-1079, May 2009.
- [12] Y. G. Hegazy, M. M. A. Salama and A. Y. Chikhani, "Adequacy assessment of distributed generation systems using Monte Carlo Simulation," *IEEE Trans. Power System*, vol. 18, pp. 48-52, Feb. 2003.
- [13] D. Issicaba, J. A. Pecos Lopes and M. A. da Rosa, "Adequacy and Security Evaluation of Distribution Systems With Distributed Generation," in *IEEE Transactions on Power Systems*, vol. 27, no. 3, pp.1681-1689, 2012.
- [14] P. Djapic, G. Strbac, R. Allan and K. Jarrett, "Quantifying security contribution from distributed generation," *Electricity Distribution, 2005. CIRED 2005. 18th International Conference and Exhibition on*, pp. 1-5, Jun. 2005.
- [15] W. Wangdee and R. Billinton, "Probing the intermittent energy resource contributions from generation adequacy and security perspectives," *IEEE Trans. Power Systems*, vol. 27, no. 4, pp. 2306-2313, Nov. 2012.
- [16] Z. Zhang, J. Li, F. Li, C. Budd, and V. Hamidi, "Assessment of DG security contribution on transmission levels," *Power and Energy Society General Meeting, 2014 IEEE*, pp. 1-5, Jul. 2014.
- [17] Z. Zhang, F. Li, C. Budd, and Y. Yuan, "Evaluation of DG contribution considering network reliability," *Challenges of implementing Active Distribution System Management, CIRED 2014 Workshop*, pp. 1-4, Jun. 11-12, 2014.
- [18] Z. Zhang, *Contributions of Distributed Generation to Electric Transmission System*. Ph.D. thesis, 2017, University of Bath, UK.
- [19] National Grid. National Electricity Transmission System Security and Quality of Supply Standard (NETS SQSS), v2.3, Feb. 2017.
- [20] Energy Networks Association. Engineering Report 130: Guidance on the Application of Engineering Recommendation P2, Security of Supply, Issue 3, 2019.
- [21] Energy Networks Association, Engineering Recommendation P2, Security of Supply, Issue 7, 2019.
- [22] S. Liang, M. Fan and F. Yang, "Research on security standards of power supply in China and UK," *Power System Technology (POWERCON), 2010 International Conference on*, pp. 1-5, Oct. 2010.
- [23] D. Cheng, D. Zhu, R. P. Broadwater, and S. Lee, "A graph trace based reliability analysis of electric power systems with time-varying loads and dependent failures," *Electric Power Systems Research*, vol. 79, pp. 1321-1328, Sep. 2009.
- [24] A. Keane, L. F. Ochoa, E. Vittal, C. J. Dent, and G. P. Harrison, "Enhanced utilization of voltage control resources with distributed generation," *IEEE Trans. Power Systems*, vol. 26, no.1, pp.252-260, 2011.
- [25] D. Pudjianto, M. Aunedi, P. Djapic and G. Strbac, "Whole-Systems Assessment of the Value of Energy Storage in Low-Carbon Electricity Systems," in *IEEE Transactions on Smart Grid*, vol. 5, no. 2, pp. 1098-1109, March 2014.
- [26] P. Zhou et al., "Reliability evaluation of grid-connected micro-grid considering demand response," *2016 International Conference on Probabilistic Methods Applied to Power Systems (PMAPS)*, pp. 1-5, 2016.
- [27] KEMA Limited and Imperial College, "Final report: Review of distribution network design and performance criteria," Ofgem, Rep. G06-1646 Rev 003, Jul. 2007.
- [28] R. Allan and G. Strbac, "Network security standards with increasing levels of embedded generation," UNIST, Manchester, Rep. K/EL/00287, Aug. 2002.
- [29] R. Allan, G. Strbac and K. Jarrett, "Security contribution from distributed generation (extension part II)," UMIST/PPA, Rep. K/EL/00287/REP, Dec. 2002.
- [30] R. Allan, G. Strbac, P. Djapic and K. Jarrett, "Developing the P2/6 methodology," UMIST, Rep. DG/CG/00023/REP, Apr. 2004.
- [31] Power Planning Associates, "WS3 P2/6 Data Collection Final Report," Feb. 2004.
- [32] M. N. Hidayat, F. Li, "Impact of distributed generation technologies on generation curtailment," *Power and Energy Society General Meeting (PES), 2013 IEEE*, pp. 1-5, 21-25 Jul. 2013.
- [33] J. Rogers, S. Fink, and K. Porter, Examples of Wind Energy Curtailment Case Studies, National Renewable Energy Laboratory, Tech. Rep. NREL/SR-550-46716, 2009.
- [34] L. Zhou, F. Li, C. Gu, Z. Hu, and S. L. Blond, "Cost/benefit assessment of a smart distribution system with intelligent electric vehicle charging," *IEEE Trans. Smart Grid*, vol. 5, no. 2, pp. 839-847, Mar. 2014.
- [35] S. C. E. Jupe, P. C. Taylor, "Distributed generation output control for network power flow management," *Renewable Power Generation, IET*, vol. 3, no. 4, pp. 371-386, Dec. 2009.
- [36] Power System Test Case Archive, University of Washington, [online]. Available: <http://www.ee.washington.edu/research/pstca>.
- [37] I. H. Gil, *Integrated assessment of quality of supply in future electricity networks*. Ph.D. thesis, 2014, University of Edinburgh, UK.
- [38] M. B. Ndawula, I. Hernando-Gil, R. Li, C. Gu and A. De Paola, "Model Order Reduction for Reliability Assessment of Flexible Power Networks," *International Journal of Electrical Power & Energy Systems*, Volume 127, 2021, 106623, ISSN 0142-0615.
- [39] M. B. Ndawula, S. Djokic and I. Hernando-Gil, "Formulation of Reliability Equivalents of LV Networks by State Enumeration and Monte Carlo Simulation Techniques," submitted to *IEEE Transactions on Power Systems*, March 2021 (under review).
- [40] I. Hernando-Gil, Z. Zhang, M. B. Ndawula and S. Djokic, "DG Locational Incremental Contribution to Grid Supply Level," *2020 IEEE International Conference on Environment and Electrical Engineering and IEEE Industrial and Commercial Power Systems Europe (EEEIC / I&CPS Europe)*, Madrid, Spain, 2020, pp. 1-6.