



HAL
open science

Balkan endemic nephropathy: Role of ochratoxins A through biomarkers.

Marcel Castegnaro, Delphine Canadas, Terry Vrabcheva, Theodora Petkova-Bocharova, Ivan N Chernozemsky, Annie Pfohl-Leszkowicz

► **To cite this version:**

Marcel Castegnaro, Delphine Canadas, Terry Vrabcheva, Theodora Petkova-Bocharova, Ivan N Chernozemsky, et al.. Balkan endemic nephropathy: Role of ochratoxins A through biomarkers.. *Molecular Nutrition & Food Research*, 2006, 5 (6), pp.519-529. 10.1002/mnfr.200500182 . hal-03482000

HAL Id: hal-03482000

<https://hal.science/hal-03482000>

Submitted on 15 Dec 2021

HAL is a multi-disciplinary open access archive for the deposit and dissemination of scientific research documents, whether they are published or not. The documents may come from teaching and research institutions in France or abroad, or from public or private research centers.

L'archive ouverte pluridisciplinaire **HAL**, est destinée au dépôt et à la diffusion de documents scientifiques de niveau recherche, publiés ou non, émanant des établissements d'enseignement et de recherche français ou étrangers, des laboratoires publics ou privés.

Balkan endemic nephropathy: Role of ochratoxins A through biomarkers

Marcel Castegnaro^{1,2}, Delphine Canadas², Terry Vrabcheva³, Theodora Petkova-Bocharova⁴, Ivan N. Chernozemsky,⁴ and Annie Pfohl-Leszkowicz^{2*}

¹International Agency of Research on Cancer, Lyon, France

²Laboratoire de Génie Chimique, UMR CNRS/INPT/UPS no. 5503, Département Bioprocédés and Systèmes Microbiens, Auzeville-Tolosane, France

³National Center of Hygiene, Mycotoxicological Laboratory, Sofia, Bulgaria

⁴Institute of Oncology, Sofia Darvenitza, Bulgaria

Several studies implicated mycotoxins, in endemic kidney disease geographically limited to Balkan region (Balkan endemic nephropathy (BEN)). In Bulgaria, much higher prevalence of ochratoxin A (OTA), exceeding 2 µg/L, was observed in the blood of affected population. OTA is found more often in the urine of people living in BEN-endemic villages. To confirm and quantify exposure to OTA in Vratza district, we followed up OTA intake for 1 month, OTA in blood and urine from healthy (20–30 years old) volunteers, from two villages with high risk for BEN disease. Food samples were collected daily, blood and urine at the beginning of each week. Relations between increasing OTA intake, blood concentration and elimination of OTA in urine have been studied in rats. Average weekly intake of OTA varies from 1.9 to 206 ng/kg body weight, twice tolerable weekly intake recommended by JECFA. OTA blood concentrations are in the same range as previously reported in this region with concentrations reaching 10 µg/L. Weekly OTA food intake is not directly correlated with blood and urine concentrations. Biomarkers of biological effects such as DNA adducts were detected in patients affected by urinary tract tumours (UTT) and in rat study. All these plead for the implication of OTA, in BEN and UTT.

Keywords: Balkan endemic nephropathy / Blood / Food / Mycotoxins / Ochratoxin A

1 Introduction

The attention of nephrologists was attracted in the 1950s by scientific publications from Bulgaria [1], former Yugoslavia [2] and Romania [3] describing a kidney disease found in geographically limited areas of these Balkan countries called Balkan endemic nephropathy (BEN). The pathology of BEN was critically reviewed by the World Health Organisation [4]. Association between BEN and urinary tract tumours (UTT) was also recognized early on and the problem of BEN thus turned out to be not only nephrological but also oncological [5, 6].

The clustering of BEN at the familial (Fig. 1) and even more at household level has been described in all Balkan countries [7]. BEN incidence is about 2–5 *per* 1000 in the endemic area in Bulgaria, Croatia. UTT incidence in this region is about 0.5 *per* 1000. Females are more affected than males by both diseases.

Many hypotheses have been put forward including genetic predisposition, infectious cause, metal *etc.* ([8] for review). The familial character of the disease suggests the hypothesis of involvement of predisposing genes. This is however not in accordance either with the observation of Hall and Dammin [9] on twins separated at birth (one developing the disease, the other not), or with that of Čeovic *et al.* [10] who observed that Ukrainian migrants acquired the disease after settling in Croatia.

The theory of the involvement of metals in the aetiology of BEN is supported by the facts that: (i) heavy metals cause

Correspondence: Dr. Marcel Castegnaro, Les Collanges, 07240 Saint-Jean Chambre, France.

E-mail: castegnaro.marcel@free.fr

Fax: +33 4 75 58 08 27

Abbreviations: BEN, Balkan endemic nephropathy; BI, Beli Izvor; bw, body weight; GP, Gorno Peshtene; OTA, ochratoxin A; PTWI, provisional tolerable weekly intake; UTT, urinary tract tumours; VSD, virtually safe dose

* Additional corresponding author: Annie Pfohl-Leszkowicz, E-mail: leszkowicz@ensat.fr

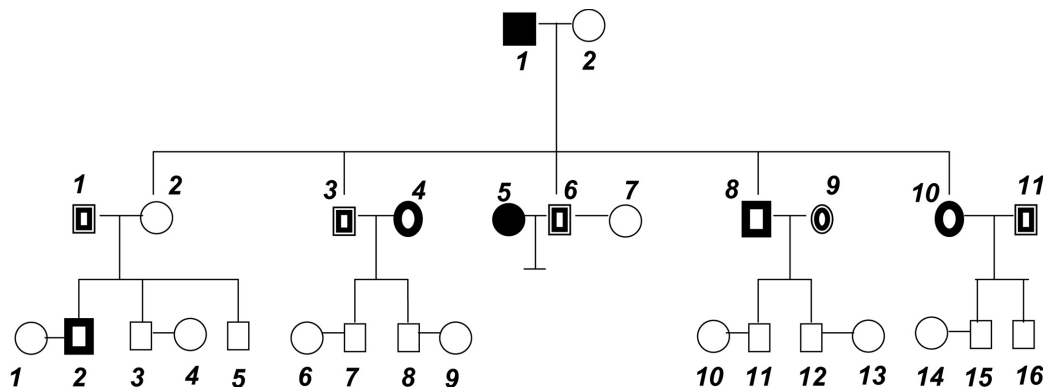

Figure 1. Example of Pedigree of one family. □ ○ Normal male and female. ■ ● Male and female affected by UTT. ■ ● Male and female suffering BEN. ■ ● Male and female affected by BEN and UTT. □ ○ Marriage. □ ○ Marriage with no offspring 17 persons under 30-year-old are not shown (eight males and nine females).

serious injury to the kidney tubular apparatus; (ii) there are some morphological similarities between BEN and nephritis experimentally induced by some heavy metals and (iii) the diseases occur in middle aged or old people, which is consistent with the hypothesis of a long-term exposure to a causative agents. However, levels of heavy metals specifically in the BEN villages are not consistently high and they do not exceed the WHO recommendations or are below the LOD of the analytical methods used; there are no clinical signs of heavy metal poisoning either in BEN patients or in domestic animals, and the observed clustering of BEN cannot be explained at the village/family level by this hypothesis. Thus, the data do not support the hypothesis of the involvement of heavy metals or other minerals in the aetiology of BEN. Nevertheless, the theory that a deficiency rather than an excess of trace elements is associated with BEN cannot be ruled out. Selenium has an active role in some detoxifying enzymes, which may be involved in ochratoxin A (OTA) detoxification.

Another hypothesis suggests that BEN and UTT may have an infectious aetiology. This includes: (i) the clustering of the disease where the infection could be more easily transmitted to members of the family, (ii) the occurrence of the diseases among migrants who may have been infected when settling in the region and (iii) the presence of virus-like particles in the kidney tissues. However, urinary tract infection is rarely found in BEN patients, and the disease is not contagious, as might be expected with an infectious agent. Furthermore, the data from different research groups are very contradictory.

Much stronger evidences support the hypothesis that BEN and the associated UTT have mycotoxic aetiology. This is supported by: (i) the rural repartition of the diseases where the population consume their own food stored always in the same place (some mycotoxins such as OTA and citrinin,

develops during storage of grain); (ii) the house clustering of the disease consistent with the previous observation; (iii) OTA, citrinin and toxins from *Penicillium aurantiogriseum* are nephrotoxic; (iv) OTA induces renal tumours in rats and mice. These effects are enhanced by the presence of citrinin, also known to be produced by moulds in Bulgaria; (v) the pathological characteristic is similar to OTA-induced nephropathy in pig [11] and (vi) DNA adducts patterns resembling those induced by OTA in mouse, rat, pig and chicken kidney have been found in human renal pelvic and bladder tumours (see Fig. 2).

Mycotoxins, particularly OTA, have been found to contaminate 8–12% of the cereals from BEN area in Croatia. In Bulgaria, OTA and citrinin were consistently detected in the staple food (beans and maize) from the affected families at frequencies multiplied two to three times for higher concentrations (>10 µg/kg for OTA in beans, >25 µg/kg for OTA in maize and >50 µg/kg for citrinin in both commodities) than in control families [8, 12, 13].

The human exposure to OTA was further supported by a higher prevalence of OTA concentration exceeding 2 µg/L in the blood of affected families. OTA has also been found more often in the urine of people living in BEN-endemic villages than in those in nonendemic villages, and the highest amounts were seen in patients with BEN or UTT [14–16].

An approach for further evaluation of exposure to OTA is the measurement of the concentrations of the mycotoxin in human blood. Due to the long persistence of OTA in the body (binding to serum albumin, reabsorption after biliary excretion and/or kidney) this reflects both recent and chronic exposures at the level of the individual and could be very useful in epidemiological studies. Urinary OTA analysis is relatively unexplored but presents the advantage of being less invasive than blood monitoring.

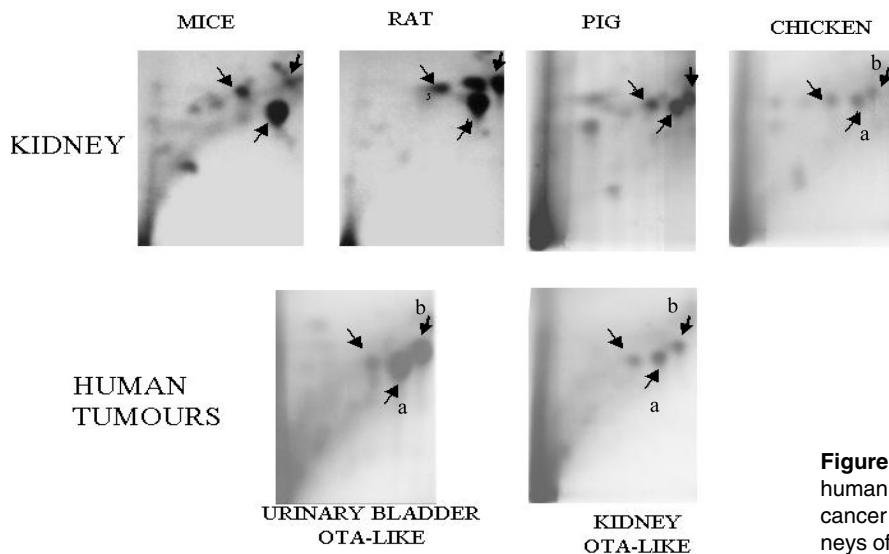

Figure 2. Example of DNA modifications in human suffering from kidney or urinary bladder cancer compared with DNA modifications in kidneys of rodents, pigs or chicken fed with OTA.

In order to confirm the exposure of population to OTA in the Vratza district in Bulgaria, which is a high-incidence area of BEN/UTT, and to establish if a correlation could be drawn between OTA food intake, OTA blood concentration and urinary OTA excretion, we followed some individuals for 1 month using the methodology described by Gilbert *et al.* [17]. In parallel, we analysed the same parameters (blood concentration, OTA excretion and DNA adduct in relation of OTA food intake) in rat fed with increasing amount of OTA for 1 month.

2 Materials and methods

2.1 Human study

2.1.1 Study subjects

Volunteers (20–30-year old) in two villages (Gorno Peshtene (GP) and Beli Izvor (BI)) in the Vratza district, an area of high incidence of BEN, have been selected (5 in GP and 11 in BI). These volunteers were healthy (normal serum and urinary formulae, without any renal, hepatic, cardiovascular or gastrointestinal disorders). They did not consume either excessive alcohol or drug.

2.1.2 Collection of food

Participants were asked to eat their usual food for 1 month. Food samples were collected following the duplicate diet method described by Gilbert *et al.* [17] each day and stored at -20°C . Each week the food was pooled and homogenized. Some beverages were collected separately. All homogenates were stored at -80°C until analysis.

2.1.3 Blood and urine collections

About 10 mL of blood were collected at days 0, 7, 14, 21 and 28. The 24-h urines were collected 1 day before start, and then at days 6, 13, 20 and 27. All samples were stored at -80°C until analysis.

2.1.4 Analysis of food samples

The food samples analysis is described in details in Vrabcheva *et al.* [18].

2.1.5 Analysis of blood and urine

The samples were analysed as described in details in Petkova-Bocharova *et al.* [19]. Briefly acidic extraction of OTA was used, followed by immunoaffinity cleanup and detection by HPLC/spectrofluorimetry (excitation of 335 nm and emission at 465 nm).

2.2 Rat study

2.2.1 Animal treatment

Dark Agouti rats, 7-wk-old, were housed in individual cages (43 cm \times 21.5 cm \times 20 cm) and kept under environmentally controlled conditions (ventilation, 22°C , 12 h dark/light cycles).

During a 7-day acclimation period, all animals were fed with wheat. All animals had free access to wheat and water. After this period, they were fed for 28 days with OTA-contaminated wheat.

For each dosing, five females and five males were fed. Rats were put in metabolic cages once a week, until the end of study to collect urine. On completion of the treatment per-

iod, animals were killed and the organs were frozen immediately at -80°C .

Plasma sample was obtained following centrifugation of 1 mL of venous blood, taken in a tube containing lithium heparinate, from the orbital sinus of the animal on day 28. Urines and plasma samples were kept at -20°C .

2.2.2 Preparation of animal diet

Cleaned wheat grains for milling from a single batch were used. One aliquot was used as control batch. Five other aliquots were artificially contaminated with OTA at respective amounts of: 2, 5.5, 40 or 100 $\mu\text{g}/\text{kg}$. The enrichment with OTA was performed as follows: (i) a standard solution of OTA was prepared by dissolving 6 mg OTA in 600 mL of ethanol; (ii) wheat (9.750 kg) is accurately weighed and transferred in a reactor in presence of 1% of water; (iii) to obtain an homogeneous contamination, OTA solution is introduced in the reactor under pressure as spray of very fine droplets; while the reactor is running, the respective volumes of the OTA solution (6 mg/600 mL ethanol) injected were 2.44, 6.83, 39 and 97.5 mL to obtain the following OTA concentrations in wheat: 2, 5.5, 40 or 100 $\mu\text{g}/\text{kg}$; (iv) the run is continued for 15 min.

The contaminated wheat was then conditioned in an individual bag of 150 g under vacuum. The initial contamination and the final contamination were analysed by two independent laboratories.

2.2.3 OTA extraction

OTA is extracted from wheat following the method described by Molinié *et al.* [20]. Briefly, a 25 g grind wheat sample is extracted, under rotator agitation, with 200 mL of

ACN/water (9:1), water containing 4% KCl and 0.4 mL of pure sulphuric acid. After filtration, a 100 mL aliquot was defatted twice with 50 mL of *n*-hexane. Following addition of 25 mL of water, the ACN/water phase is extracted three times with chloroform (50, 10 and 10 mL). The combined chloroform extract were portioned three times against 25 mL of 5% sodium hydrogen bicarbonate. The combined aqueous phases are acidified to pH 1.5 with hydrochloric acid and reextracted three times with chloroform (50, 25 and 25 mL). The combined chloroform extract was dried under vacuum, at 45°C . Once dried, the extract is dissolved in 1 mL of methanol, filtered in a 0.2 μm filter, and dried under nitrogen flow. Finally, the filtrate was dissolved in 500 μL of methanol and placed at -20°C . OTA in blood and urine is extracted as described above.

2.2.4 DNA adduct detection

DNA adduct were detected as described in details in Pfohl-Leskowicz and Castegnaro [21].

3 Results

Table 1 summarizes the data concerning OTA amount in food, blood and urine of Bulgarian volunteers. OTA was detected in 50% of the food samples from GP and in 78% of samples from BI (detailed data in Vrabcheva *et al.* [18]). The detectable amounts found in the diet ranged from 0.07 to 0.25 $\mu\text{g}/\text{kg}$ for GP samples, and from 0.07 to 2.60 $\mu\text{g}/\text{kg}$ for BI samples. The amounts of food consumed weekly by the subjects varied considerably from 2000 to 7950 g for GP and from 700 to 8000 g for BI. After calculation taking into account the weight of food, the OTA consumed weekly by subjects from GP ranged from 98 to 1550 ng/wk; and by

Table 1. Average and SD of weekly OTA intake, blood and urine concentrations, and OTA urinary excretion

Averages \pm SD	OTA consumed (ng/wk)	OTA concentration in serum (ng/L)	OTA concentration in urine (ng/L)	OTA excreted in urine (ng/day)
GP 01	224 \pm 184	460 \pm 190	22 \pm 23.9	11.8 \pm 11.8
GP 02	521 \pm 263	440 \pm 150	16 \pm 8.9	9.42 \pm 5.63
GP 03	198 \pm 120	540 \pm 360	54 \pm 23.0	23.0 \pm 6.6
GP 04	582 \pm 360	1460 \pm 190	64 \pm 36.5	39.0 \pm 17.2
GP 09	369 \pm 389	440 \pm 290	98 \pm 129.9	72.7 \pm 77.9
BI 02	1968 \pm 1669	260 \pm 150	54 \pm 36.5	56.0 \pm 28.8
BI 03	1220 \pm 280	1700 \pm 610	92 \pm 43.8	66.2 \pm 22.6
BI 05	321 \pm 170	560 \pm 310	37.5 \pm 20.6	27.4 \pm 14.3
BI 06	85 \pm 93	720 \pm 220	74 \pm 50.8	55.1 \pm 31.7
BI 07	6373 \pm 6656	8360 \pm 1560	860 \pm 656.2	1272.4 \pm 888.3
BI 08	6489 \pm 4607	7700 \pm 2200	455 \pm 237.0	618.5 \pm 304.9
BI 09	442 \pm 189	540 \pm 90	36 \pm 31.3	32.3 \pm 29.5
BI 11	305 \pm 188	700 \pm 220	82.5 \pm 67.0	88.5 \pm 72.4
BI 12	115 \pm 30 ^{a)}	360 \pm 210	34 \pm 21.9	19.9 \pm 11.9

a) Based on LOQ

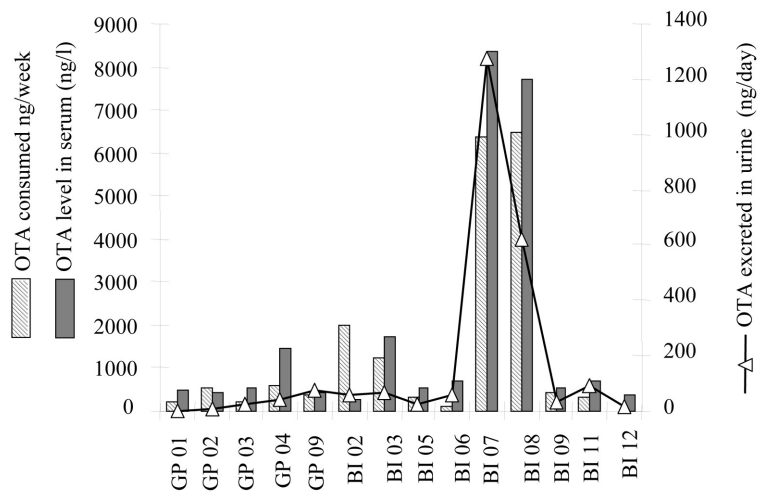

Figure 3. Overall comparison of OTA intake, serum OTA and urinary OTA excretion.

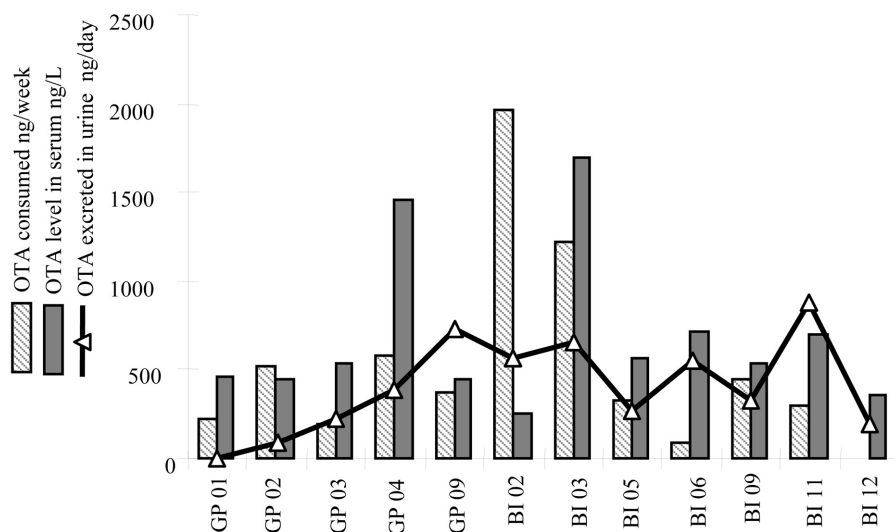

Figure 4. Comparison of OTA intake, serum OTA and urinary OTA excretion after exclusion of the two individuals with extremely high intake of OTA.

subjects from BI ranged from 110 to 14152 ng/wk. For some individuals, the weekly variation of intakes are very large (*i. e.* GP09, BI02, BI07 and BI08), while other have a steady intake.

OTA has been detected in all sera ranging from 0.1 to 1.6 $\mu\text{g/L}$ for GP and 0.1–10.9 $\mu\text{g/L}$ for BI. OTA was detected in 88% urine samples from GP ranging from 0.01 to 0.33 $\mu\text{g/L}$ and 97.6% in BI urine in the range of 0.01–1.91 $\mu\text{g/L}$. After taking into account the volume of urine excreted, OTA excretion varied from 4.3 to 212 ng/day for GP and 6.4–2672 ng/day in BI (see [19] for detailed data). The serum concentration of OTA and the urinary excretion were fairly constant over the five analyses for some individuals, whereas for others they varied widely, up to five-fold for blood and seven-fold for urine.

When comparing the average values of OTA intake, serum OTA and urinary OTA excretion of all volunteers, an apparent correlation between the three parameters seems to be

observed (Fig. 3). Indeed for BI 07 and BI 08, high excretion and high blood contents correlate with high OTA intake.

In order to study more precisely the relation between intake, distribution and excretion, we have drawn the curve without the two individuals having very high intake (BI 07 and BI 08) (Fig. 4). Several observations could be made: (i) high OTA intake is not always reflected by high serum OTA concentration (individual BI 02); (ii) the highest serum concentration is not related to the highest OTA consumption (individuals GP 04 and BI 03).

In Fig. 5 we represent the diagrams of OTA consumption, serum OTA and OTA excretion over the month for three individuals, BI 12, BI 06 and BI 02. These individuals have OTA blood concentration in the same range (0.1–0.7 $\mu\text{g/L}$ on a weekly basis); nevertheless, their OTA intake was very different, constantly very low for all the months for BI 12 (below the LOD) and for BI 06 (average intake of 1.6 ng/kg

body weight (bw)/wk), about six times higher for some weeks for BI 02 (ranging from 5 to 50 ng/kg bw/wk). Although, the weekly OTA food intake of individual BI 02 is up to 30 times higher than that of BI 12 or BI 06, the OTA blood concentration is lower ($<0.3 \mu\text{g/L}$), because as soon as his OTA intake increases he compensates the intake by an increase of his OTA excretion. For individuals BI 06 and

BI 12, their blood OTA concentration is relatively high compared to their intake. Nevertheless, increase of OTA blood concentration is rapidly compensated by increasing urinary OTA excretion which brings back OTA concentration to the original steady-state in the blood ($0.5 \mu\text{g/L}$). The OTA blood steady-state concentration of BI 02 is $0.3 \mu\text{g/L}$.

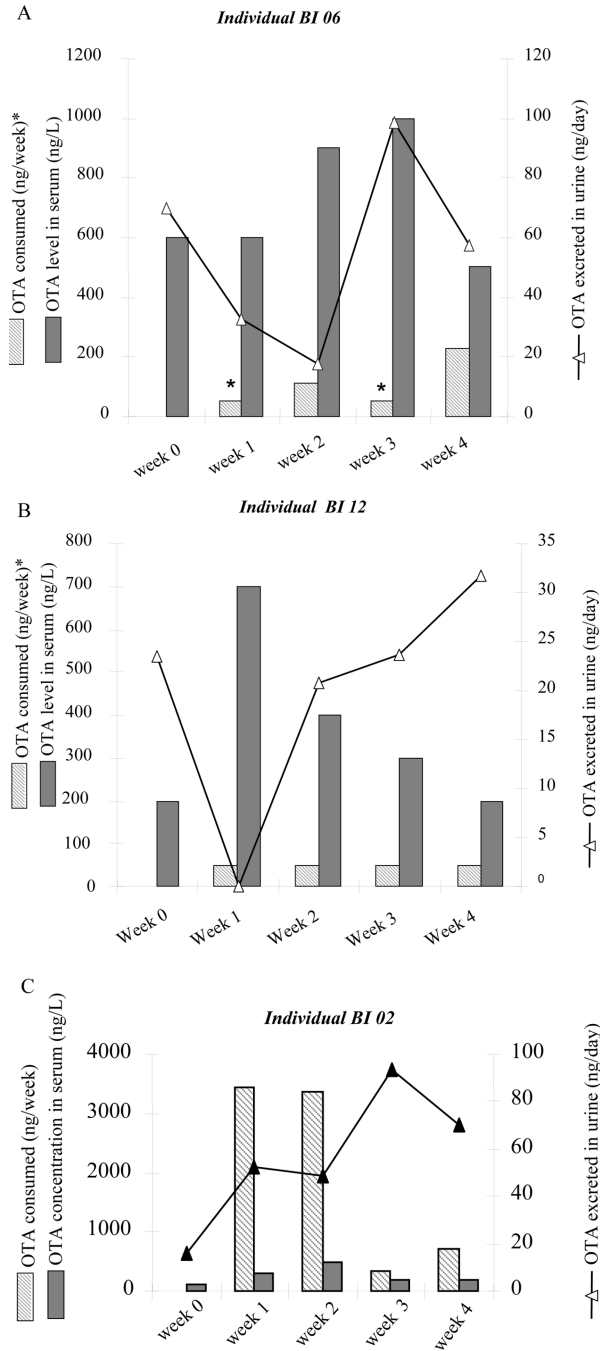

Figure 5. Comparison of OTA intake, serum OTA and urinary OTA excretion from three volunteers. (A) Individual BI 06. * Value corresponding to half the LOQ. (B) Individual BI 12. * Value corresponding to half the LOQ. (C) Individual BI 02.

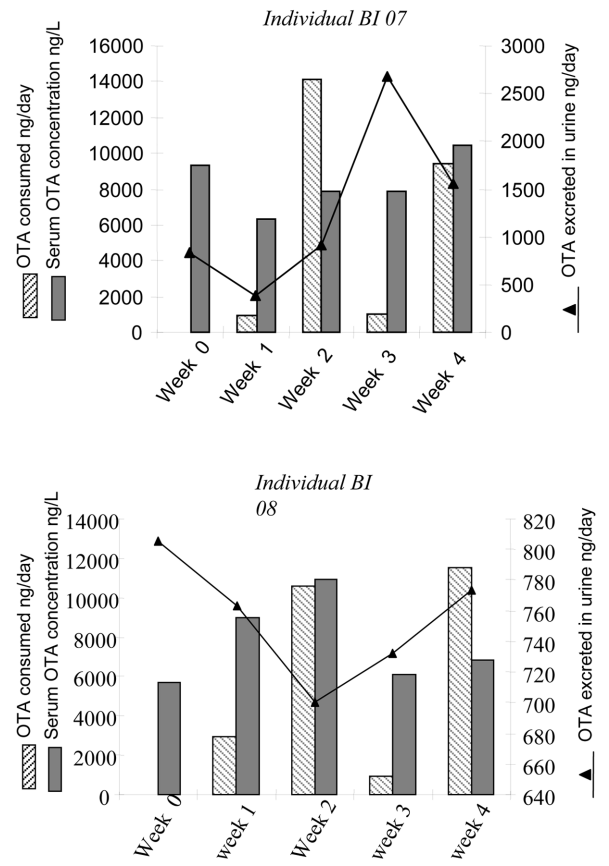

Figure 6. Comparison of OTA intake, serum OTA and urinary OTA excretion from individual BI 07 and BI 08 having a high OTA blood concentration.

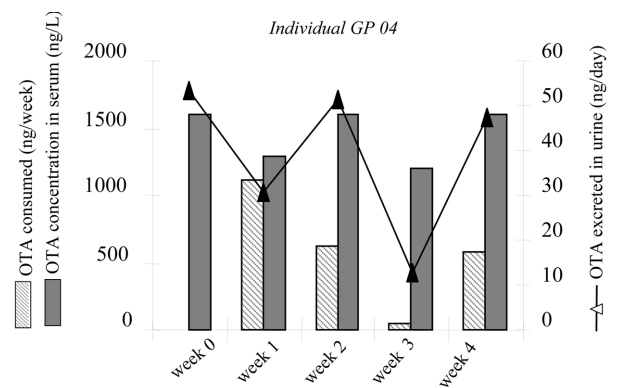

Figure 7. Comparison of OTA intake, serum OTA and urinary OTA excretion from individual GP 04.

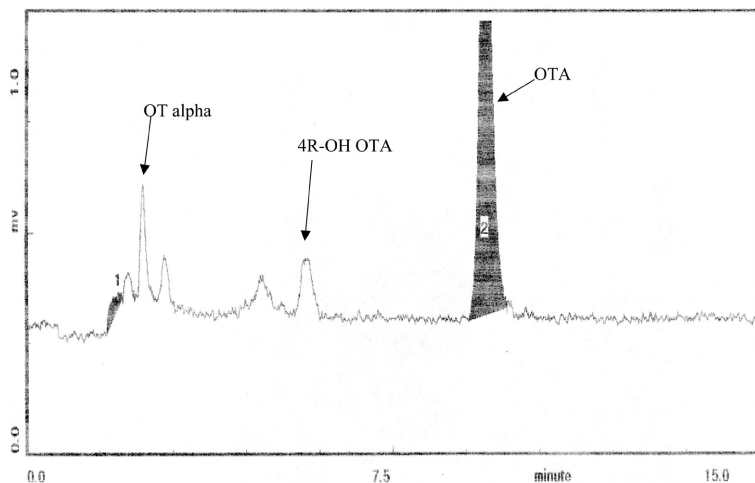

Figure 8. HPLC separation of OTA derivatives extracted from human urine.

Figure 6 shows the diagram of OTA consumption, serum OTA and OTA excretion over the month for individuals BI 07 and BI 08 who have a high serum OTA concentration ($>7 \mu\text{g/L}$). Both individuals have constantly high blood OTA concentrations although their intake is alternatively low or very high. Indeed for some weeks the intake is low (*i.e.* weeks 1 and 3, about 900–1000 ng/wk, equivalent to 1.8 ng/kg bw/day, for BI 07) followed by an extremely high intake (*i.e.* reaching 14 000 ng/wk, equivalent to 28.57 ng/kg bw/day, for BI 07). Their global excretion is always much more important (*i.e.* 700–2500 ng/day for BI 07) than all other individuals (average excretion 9–70 ng/day). Interestingly, an increase of OTA food intake is followed by an increase of excretion the week after.

Figure 7 depicts the diagram of OTA consumption, serum OTA and OTA excretion over the month for individuals GP 04 who have an OTA blood steady-state concentration over the month of $1.46 \pm 0.19 \mu\text{g/L}$, although his intake is relatively low (600–1100 ng/wk, equivalent to 1.2–2.2 ng/kg bw/day).

In addition, all individuals excreted in their urine several OTA metabolites, notably OT alpha and 4-OH-OTA (Fig. 8). These metabolites have not been quantified.

Altogether these data indicate that OTA blood level is relatively stable over a period of 1 month for a given individual and is regulated by urinary excretion. As long as the OTA food intake is relatively low, a variation of OTA food intake is not directly reflected by a variation of OTA blood concentration. This could be explained by the fact that the free fraction of toxin in plasma is less than 0.2% in all species including man as long as the binding sites are not saturated [22]. Indeed, OTA is bound to proteins and stored in tissues, and thus could not be excreted directly by glomerular filtration. In organism, equilibrium exists between the bound and free form of OTA in blood as well as in tissue.

To explain these phenomena, we have fed rats for 4 wk with wheat contaminated with a 200-fold range of OTA amounts. OTA content in wheat was analysed at the beginning and at the end of the feeding period by two independent laboratories. No evolution of OTA contamination has been observed during the feeding period. The average values (ten independent analyses) were: 0.5 ± 0.5 ; 2.5 ± 0.5 ; 5.5 ± 1 ; 38 ± 2 ; $97 \pm 3 \mu\text{g/kg}$ corresponding to an intake of 50; 250; 550; 4000; 10 000 ng/kg bw/day based on a food consumption of 20 g of food by animal weighing 200 g. The OTA blood concentration increases with OTA intake reaching 30 or 40 $\mu\text{g/L}$ in male and female blood, respectively, for an intake of 10 000 ng/kg bw/day. Blood OTA concentration increase is not proportional to the dose (Fig. 9). In males, OTA urinary excretion is not dependent on OTA exposures of the rats (Fig. 10). Indeed, comparable amounts of OTA are detected in urines of male rats receiving wheat contaminated either with 0.5 ± 0.5 ; 2.5 ± 0.5 ; 5.5 ± 1 ; 38 ± 2 ; $97 \pm 3 \mu\text{g/kg}$ wheat, with a plateau around 40 ng/day. On the contrary, OTA urinary excretion in females increases when OTA intake increases. For high intake (14 000 ng/kg bw/day) the amount of OTA excreted by female rats every day is about seven-fold higher than that excreted by male rats (Fig. 10). Several OTA metabolites were also found in urine, notably OT alpha and 4-OH-OTA, but were not quantified (data not shown).

DNA adducts have been analysed by the post labelling method in kidney of male and female rats. An example of kidney DNA adduct of rat fed OTA-contaminated wheat is given Fig. 11. The DNA-adducts called a, b correspond to the DNA adducts observed in other animals and human exposed to OTA (arrows a and b in the right of Fig. 2). Adduct b is formed in male and female rats even with intake as low as 50 ng/kg bw/day. The amount of this adduct after treatment with the highest dose tested is about two times higher in female (190 adducts/ 10^9 nucleotides) than in male

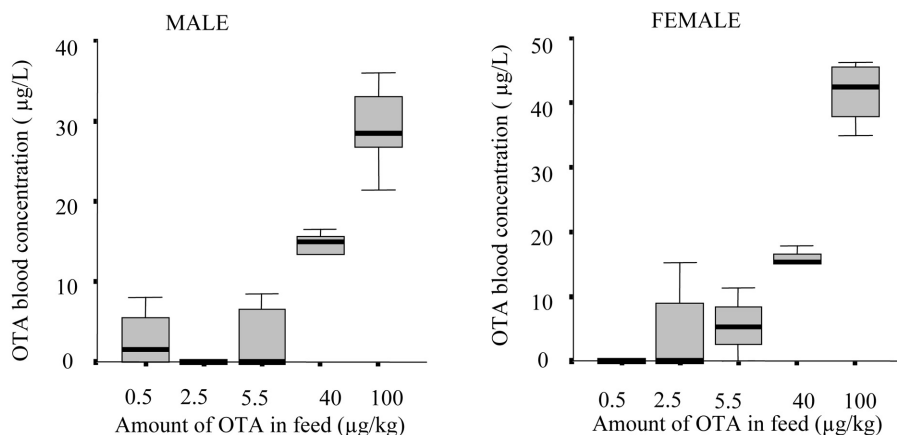

Figure 9. OTA blood concentration of rat receiving feed with increasing amount of OTA.

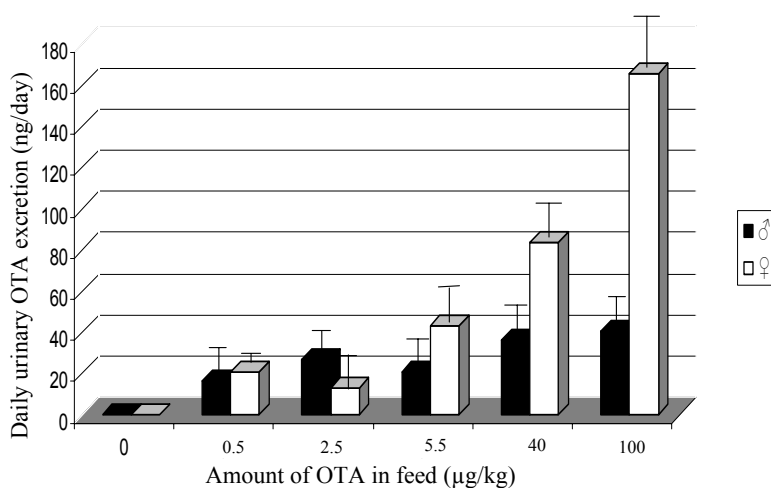

Figure 10. Relation between daily urinary OTA excretion and OTA consumption from feed in male and female rats.

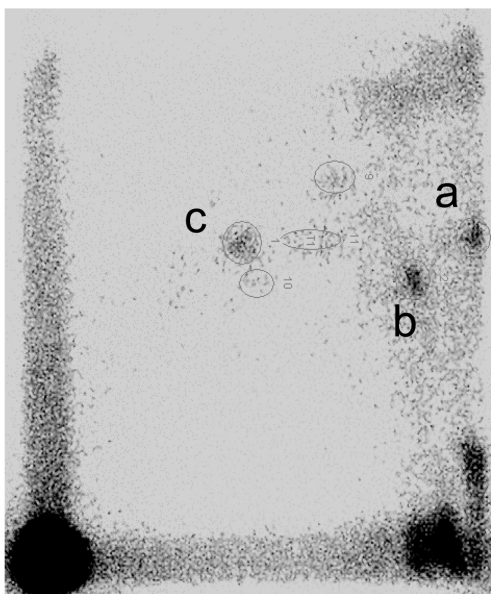

Figure 11. Example of kidney DNA adduct from rat fed OTA-contaminated wheat for 28 days.

rats (108 adducts/ 10^9 nucleotides). DNA adducts a and c are essentially formed in male kidney. With lowest dose tested, DNA adduct a corresponds to 18 adducts/ 10^9 nucleotides and reached a plateau of 50 adducts/ 10^9 nucleotides after dosing at 2.5 ± 0.5 µg/kg. DNA adduct c is only detectable for treatment with 38 ± 2 µg/kg food (equivalent to an intake of 4 µg/kg bw/day) or 97 ± 3 µg/kg food (equivalent to an intake of 10 µg/kg bw/day), and reached 28 adducts/ 10^9 nucleotides in male kidney.

4 Discussion

The aims of this work was: (i) to confirm the exposure of population to OTA in the Vratza district in Bulgaria, which is a high-incidence area of BEN/UTT, (ii) to establish if a correlation could be drawn between OTA food intake, OTA blood concentration and urinary OTA excretion and (iii) to define biomarkers of OTA exposure. The results obtained during the study on human confirm the previous data in the same area of Bulgaria in that: (i) food from BEN area can be highly contaminated by OTA and at high frequency; (ii)

highest OTA blood concentrations are around 10 $\mu\text{g/L}$, with 12.5% of them greater than 2 $\mu\text{g/L}$; (iii) there is a high incidence of urinary OTA excretion, reaching up to 2 $\mu\text{g/L}$. Moreover, OT alpha and 4-OH-OTA were detected in all urine samples.

Comparison of the three parameters for each volunteer allows some explanations concerning the OTA storage capacity for each volunteer. This is modulated by the urinary excretion of OTA. Interestingly, increase of OTA intake does not result in an immediate increase of OTA elimination, but only the week after high contamination. Indeed, for individuals BI 02, BI 07 or BI 08, high OTA intake on week 2 was followed by an increasing OTA elimination on week 3. On the contrary, when the OTA intake is low (BI 12 and BI 06), OTA elimination is modulated by OTA blood concentration. Surprisingly, OTA blood concentration is higher for these two individuals (BI 12 or BI 06) for which OTA intake is very low. The same scheme is observed for individual GP 04 for which a regular and continuous OTA intake equivalent to 1.2–2.2 ng/kg bw/day leads to an OTA blood steady-state concentration of 1.46 $\mu\text{g/L}$. In fact, these results could be explained by the ability of OTA to bind proteins. Once OTA reaches the bloodstream, it is bound at more than 99% to serum proteins, which facilitates its passive absorption in the nonionized form, but hinders its glomerular filtration. OTA is bound with albumin (binding saturation above several hundred micrograms *per* millilitre of serum) [23], but also strongly to other small proteins (20 000 Da), for which binding saturation is reached with a OTA concentration of 10–20 ng/mL [24]. The fraction of OTA bound to proteins constitutes a mobile reserve of OTA than can be released as soon as the OTA free amount decreases. OTA is excreted in tubule using organic anion transporter proteins (OAT) [25–27]. OTA is then reabsorbed in all nephron segments using OAT or other transporters [28]. This delays the elimination and thus increases the risk of accumulation of OTA in tissues. We observe that elimination for human is low (average value comprise between 20 and 80 ng/day) independently of the dose ingested, till the intake is below 100 ng/kg bw/week. The excretion for low intake is in the same range as for rat. The OTA elimination increases dramatically and is multiplied by 10–50-fold for an average intake of 100 ng/kg bw/wk. It should be noticed that individual BI 02 for which intake reached sometimes 30 ng/kg bw/wk does not excrete more than other individuals having a much more lower intake. This is in accordance with the recent observation indicating that OTA uptake is dependent on the free substrate concentration and severely limited by binding to HSA [29]. Comparison of the data obtained for individual GP 04 with those of the other individuals demonstrates the complexity of the equilibrium between OTA distribution, elimination, OTA intake and transport mechanism. For this individual, regular

and continuous OTA intake equivalent to 1.2–2.2 ng/kg bw/day leads to a relatively high OTA blood steady-state concentration (1.46 $\mu\text{g/L}$) and a low OTA elimination. This could be explained by the alteration in electrolyte transport (Na^+/K^+) by a low dose of OTA [30] leading to a reduction of OTA urinary excretion and thus an increase of OTA blood concentration. Due to the equilibrium between bound OTA and free OTA (in tissue and blood), the daily intake of individual BI 06, BI 12 and GP 04 is not sufficient to saturate all protein binding sites, and thus the majority of OTA is found as free OTA in blood. The OTA elimination dramatically increase only when the OTA binding and OTA reabsorption capacity are overpassed by regular high intake (*i. e.* BI 07 and BI 08). Discontinuous OTA intake, even if some week intake is relatively high (*i. e.* BI 02), leads to an OTA blood steady-state concentration of 0.3 $\mu\text{g/L}$. Our data are in line of those of Studer-Rohr *et al.* [31] showing an intraindividual fluctuations of OTA plasma concentration in humans. These authors followed some volunteers for a 2-month period, showed rather constant OTA plasma concentrations, while for others high plasma OTA variability was observed over 3–5 days. Their kinetic experiment in humans indicated that during the first 6 days OTA is mainly distributed within the body and that only a minor fraction is excreted. During the following 69 days, the OTA plasma concentration decreased while within the same time period larger amount of OTA (and metabolites) were excreted *via* the urine. Calculation of the renal clearance demonstrate higher and lower than expected clearance rates for high and low OTA plasma concentrations, respectively. This could be interpreted as representing a filtration-mediated reabsorption process with low capacity. At high OTA plasma concentration reabsorption is saturated leading to excretion rates greater than expected [31]. Some differences in kinetic data are reported in the literature (for a review see [32]). Most of the kinetic data suggest the presence of a two-compartment open model, with blood representing the central compartment and all other organs representing the peripheral compartment. This model, even when calculating with measured OTA concentrations in the organs, did not consider the presence of active OTA transport beyond the uptake kinetics from the gastro-intestinal tract. In reality, the ‘peripheral compartment’ would have to be split into at least two compartments: one with organs with a capacity for active transport in addition to passive diffusion; and another where OTA enters into the organs *via* passive diffusion only. Thus, despite the fact that most current kinetic models calculated with a two-compartment open model, future models would have to consider three or possibly even a four-compartment open model predictors of the toxicokinetics [32]. The same is observed in rat study. Relatively high OTA blood concentration was found in rats fed with low amount of OTA. The elimination is also not directly correlated with OTA intake. Difference between

male and female rats could be explained by the fact that the expression of these transporters is sex and species dependent [33]. It is well known that OTA is a cumulative toxic. Thus, for steady-state conditions the plasma concentration is fairly constant. This is the reason why JECFA have put a provisional tolerable weekly intake (PTWI) of 100 ng/kg bw/week, based on pig nephrotoxicity. Two volunteers (BI 07 and BI 08) have an average weekly intake of 92.7 and 91 ng/kg bw, respectively, considering an average body weight of 70 kg. Some weeks their intake even reached twice this PTWI (206 ng/kg bw). In rats, DNA adducts in kidney were observed after such high intake. Considering the fact that OTA is carcinogenic and even genotoxic [21], it would be prudent to take into account as tolerable amount the 'Virtually safe dose' (VSD) of 1.8 ng/kg bw/day proposed by Kuiper-Godman [34]. This dose is calculated as TD50 (dose for which half of animal develop tumours)/50 000, and represents the probability of 1 tumour/10⁵ individuals. In this case, two additional individuals in BI village (BI 02 and BI 03) for which the OTA intake is two- to ten-fold over the VSD may be at risk. Three individuals from GP village (GP 2, GP 4 and GP 9) had also at least 1 wk during the month an intake close to or over the VSD. Interestingly, the individual GP4 who had all the month an OTA intake in the range of VSD had a steady-state OTA blood concentration of 1.46 µg/kg bw/wk. It should be kept in mind that the circulating fraction of a toxin is the only part which could have a biological effect. Thus, people with a high OTA blood concentration may have a higher risk of tumour development. It would thus be interesting to follow them for development of the diseases.

In conclusion, these data confirm those of the previous studies in humans in this area of the Balkans, in that some inhabitants have very high consumption of OTA which is in part reflected by high levels in blood and urine. However, there is no direct correlation between OTA in blood or in urine and OTA consumed; thus, OTA in blood or in urine cannot be recommended as a biomarker of the exposure. To be able to draw more reliable conclusions, it would be better to collect every day the food for one family and compare with OTA blood concentration and urinary excretion of all members of the family. This is what we have performed in the ongoing study in Serbia.

OTA DNA adducts have been found in kidney (which is the target organ of animals treated by OTA) and in humans suffering nephropathy and urothelial tract tumours, who have a high consumption of OTA, high OTA plasma and tissue concentration. It would be of interest to see if these adducts can also be detected in exfoliated cells in urine of humans. This will be a good marker of kidney damage which may lead to tumours.

Finally, the data show that some attention must be paid to individuals who exceed the PTWI from JECFA or the VSD calculated by Kuiper-Godman.

The authors want to thank NATO for supporting this project, the 'Institut National Polytechnique de Toulouse' (INPT) for providing a fellowship to Dr. T. Petkova-Bocharova to come to Toulouse, France, and Financial supports from the French Ministry of Research and Universities and the 'Midi-Pyrénées Region' Nos. 99008345 and 03001160; Safety and health research laboratory (CIT, Evreux, France) and Goemar, Saint-Malo, France for the animal study and financial support for Delphine Canadas.

5 References

- [1] Tanchev, I., Evstatiev, Z. V., Dorosiev, G., Pencheva, Z. H., Zvetkov, G., *Savr Med.* 1956, 7, 14–29 (in Bulgarian).
- [2] Danilovic, V., Djurišić, M., Mokranjac, M., Stojimirovic, B. *et al.*, *Presse Méd.* 1957, 65, 2039–2040.
- [3] Fortza, N., Negoescu, M., *Cercet Med.* 1961, 1, 217–221.
- [4] World Health Organisation, *Memoranda. The Endemic Nephropathy of South-Eastern Europe.* WHO, Geneva 1965, pp. 431–448.
- [5] Bordas, E., Bretter, E., Costin, L., Lenghel, I., *Méd. Soc. Santé Publique* 1973, 21, 481–498.
- [6] Chernozemsky, I. N., Stoyanov, I. S., Petkova-Bocharova, T. K., Nikolov, I. G. *et al.*, *Int. J. Cancer* 1977, 19, 1–11.
- [7] Petkova-Bocharova, T., Chernozemsky, I. N., Nikolov, I. G., Stoyanov, I. S., *J. Natl. Cancer Inst.* 1977, 59, 1419–1421.
- [8] Pfohl-Leszkowicz, A., Petkova-Bocharova, T., Chernozemsky, I. N., Castegnaro, M., *Food Addit. Contam.* 2002, 19, 282–302.
- [9] Hall, P. W., Dammin, G. J., *Nephron* 1978, 22, 281–300.
- [10] Ceovic, S., Hrabar, A., Radonic, M., *Nephron* 1985, 40, 175–179.
- [11] Krogh, P., *Mycotoxic porcine nephropathy – a possible model for Balkan (endemic) nephropathy.* *Endemic nephropathy, Proceedings of the second International Symposium on Endemic Nephropathy, 9–12 November 1972, Bulgarian Academy of Sciences, Sofia 1972, pp. 266–277.*
- [12] Petkova-Bocharova, T., Castegnaro, M., *Food Addit. Contam.* 1985, 2, 267–270.
- [13] Petkova-Bocharova, T., Castegnaro, M., Michelon, J., Maru, V., Ochratoxin A and other mycotoxins in cereals from an area of Balkan endemic nephropathy and urinary tract tumours in Bulgaria, in: Castegnaro, M., Plestina, R., Dirheimer, G., Chernozemsky, I. N., Bartsch, H. (Eds.), *Mycotoxins, Endemic Nephropathy and Urinary Tract Tumours*, IARC Scientific Publications No. 115, IARC, Lyon 1991, pp. 83–87.
- [14] Petkova-Bocharova, T., Chernozemsky, I. N., Castegnaro, M., *Food Addit. Contam.* 1988, 5, 299–301.
- [15] Petkova-Bocharova, T., Castegnaro, M., Ochratoxin A in human blood in relation to Balkan endemic nephropathy and urinary system tumours in Bulgaria, in: Castegnaro, M., Plestina, R., Dirheimer, G., Chernozemsky, I. N., Bartsch, H.

- (Eds.), *Mycotoxins, Endemic Nephropathy and Urinary Tract Tumours*, IARC Scientific Publications No. 115, IARC, Lyon 1991, pp. 135–137.
- [16] Castegnaro, M., Maru, V., Petkova-Bocharova, T., Nikolov, I., Bartsch, H., Concentration of ochratoxin A in the urine of endemic nephropathy patients and controls in Bulgaria: Lack of detection of 4-hydroxyochratoxin A, in: Castegnaro, M., Plestina, R., Dirheimer, G., Chernozemsky, I. N., Bartsch, H. (Eds.), *Mycotoxins, Endemic Nephropathy and Urinary Tract Tumours*, IARC Scientific Publications No. 115, IARC, Lyon 1991, pp. 165–169.
- [17] Gilbert, J., Brereton, P., Mac Donald, S., *Food Addit. Contam.* 2001, 18, 1088–1093.
- [18] Vrabcheva, T., Petkova-Bocharova, T., Grosso, F., Nikolov, I. N. et al., *J. Agric. Food Chem.* 2004, 52, 2404–2410.
- [19] Petkova-Bocharova, T., Castegnaro, M., Pfohl-Leszkowicz, A., Garren, L. et al., *Med. Biol.* 2003, 10, 57–62.
- [20] Molinié, A., Faucet, V., Castegnaro, M., Pfohl-Leszkowicz, A., *Food Chem.* 2005, 92, 391–400.
- [21] Pfohl-Leszkowicz, A., Castegnaro, M., *Food Addit. Contam.* 2005, 22 (Suppl. 1), 75–87.
- [22] Hagelberg, S., Hult, K., Fuchs, R., *J. Appl. Toxicol.* 1989, 9, 91–96.
- [23] Stojkovic, R., Hult, S., Gamulin, R., Plestina, R., *Biochem. Int.* 1984, 9, 33–38.
- [24] Schwerdt, G., Freudinger, R., Silbernagl, S., Gekle, M., *Toxicology* 1999, 135, 1–10.
- [25] Gekle, M., Silbernagl, S., *Renal Physiol. Biochem.* 1994, 17, 40–49.
- [26] Tsuda, M., Takashi, S., Takeda, M., Cha, S. H. et al., *J. Pharmacol. Exp. Ther.* 1999, 289, 1301–1305.
- [27] Jung, K. Y., Takeda, M., Kim, D. K., Tojo, S. et al., *Life Sci.* 2001, 69, 2123–2135.
- [28] Dahlman, A., Dantzler, W. H., Silbernagl, S., Gekle, M., *J. Pharmacol. Exp. Ther.* 1998, 286, 157–162.
- [29] Bow, D. A. J., Perry, J. L., Simon, J. D., Pritchard, J. B., *J. Pharmacol. Exp. Ther.* 2006, 316, 349–355.
- [30] Blazer-Yost, B. L., West, T. A., Stack, J., Peck, K. et al., *Pflügers Arch.* 2005, 450, 53–60.
- [31] Studer-Rohr, I., Schlatter, J., Dietrich, D. R., *Arch. Toxicol.* 2000, 74, 499–510.
- [32] Dietrich, D. R., Heussner, A. H., O'Brien, E., *Food Addit. Contam.* 2005, (Suppl. 1), 45–52.
- [33] Buist, S. C. N., Klaassen, C. D., *Toxicol. Sci.* 2003, 72(S-1), 259.
- [34] Kuiper-Godman, T., Risk assessment. in: Castegnaro, M., Plestina, R., Dirheimer, G., Chernozemsky, I. N., Bartsch, H. (Eds.), *Mycotoxins, Endemic Nephropathy and Urinary Tract Tumours*, IARC Sciences Publication N°115, Lyon 1991, pp. 307–320.