



HAL
open science

Impact of heat treatment on the lifetime of wire-bonded power modules

J. Brandelero, P. Pichon, Marc Legros

► **To cite this version:**

J. Brandelero, P. Pichon, Marc Legros. Impact of heat treatment on the lifetime of wire-bonded power modules. *Microelectronics Reliability*, 2021, 126, pp.114251. <10.1016/j.microrel.2021.114251>. <hal-03456270>

HAL Id: hal-03456270

<https://hal.science/hal-03456270v1>

Submitted on 31 Aug 2022

HAL is a multi-disciplinary open access archive for the deposit and dissemination of scientific research documents, whether they are published or not. The documents may come from teaching and research institutions in France or abroad, or from public or private research centers.

L'archive ouverte pluridisciplinaire **HAL**, est destinée au dépôt et à la diffusion de documents scientifiques de niveau recherche, publiés ou non, émanant des établissements d'enseignement et de recherche français ou étrangers, des laboratoires publics ou privés.



HAL Authorization

Impact of Heat Treatment on the Lifetime of Wire-Bonded Power Modules

J. Brandelero^a, P. Pichon^a, M. Legros^b

^a *Mitsubishi Electric R&D Centre Europe, Rennes, France*

^b *CEMES-CNRS, Toulouse, France*

Abstract

Wire bondings in power modules are one of the weakest links in the packaging, often leading the entire power module to failure. Thermo-mechanical stresses in the wire bonds related to CTE mismatch induce cracks that propagate in a region close to the bonding interface. In this paper, Scanning Electron Microscope (SEM) analysis after a bonding process clearly shows small grains and a different texture close to the interface of the wire and the die metallization. In order to improve the reliability of the wire bonds, a heat treatment after power module manufacturing is proposed. The heat treatment affects positively the bonding region by increasing the grain size, reducing the dislocation density and merging the grains of the wire and the metallization. Furthermore, power cycling has been performed showing an increase of the lifetime on the heat-treated power modules compared to a reference composed by the same non-treated (as-delivered) power IGBT's modules.

1. Introduction

In wire bonded power modules, one of the most dominant failure mode is wire bond lift off. It is known that the ultra-sonic bonding process creates small/micro-cracks at the bond tail, which precipitates the formation of the cyclic strain driven crack, leading to the eventual wire bond lift off [1]. The bonding process induces significant microstructural changes and grain refinement above and in the metallization area due to strain hardening and dynamic recrystallization during the bonding process (e.g. [2] [3] [4], [5]).

At the same time, several reports have shown a significant effect of the presence of oxides layer on the bond quality [6], [7], [8], [9]. One of the roles of the ultrasonic energy is to smear the native oxide layer at the metallization and wire and expose high energy surfaces for bonding. Previous works demonstrated significant positive effect of oxide plasma cleaning [10] and/or reduced time of storage prior to bonding on bond strength and degradation rate.

A positive effect of a higher average temperature during thermal cycling on bond shear strength degradation rate was demonstrated in [3], [11]. This was attributed to two thermally activated processes:

1. Wire-metallization interface stabilization: interdiffusion between metallization and wire material, ripening of oxide precipitates,

2. Material damage reduction: grain growth, softening of the material and dissipation of residual, or cycling-induced damage (dislocation structures).

Furthermore, a post-wirebond heat treatment in the Al wires bonding on the range of 280°C to 400°C demonstrated an increase in reliability in [12], and an increase of the adhesion strength between Cu wirebonding to the Al bond pad in [13].

In this paper, a heat treatment after wire bonding is proposed to increase the lifetime with temperatures on the safe operating area of the power modules (150°C-175°C). The aim of this heat treatment is to induce recrystallization between the wires and the metallization and increase the grain size in the bond. Consequently, tougher material properties are achieved with a softer material that can endure higher plastic deformations and a reduced crack growth rate.

In the first section of this paper the experimental heat treatment and power cycling tests are presented. The last section details a microstructure analysis and comparison of wire bonds between as delivered and thermal treated power modules.

2. Experimental tests and results

2.1 Sample preparation

Thermal treatment preparation procedures were developed to apply the heat treatment on IGBT power modules. The power module samples are state-of-art

*Corresponding author.

j.brandelero@fr.mercede.mee.com

IGBT devices (150A rated current) with 23 bonds of Aluminium wires per die having a diameter of 400 μ m. Two batches of thermal treatments were conducted without deteriorating the thermal interfaces, as the maximum specified junction temperature (175°C) was respected:

1. The first batch was heat treated by applying a DC current of 150A for 96 hours through the collector-emitter of IGBT dies, inducing a temperature of approximately 160°C by Joule heating. The temperature of each die was controlled using optical fiber infrared sensors (OpSens OTG-F-10-62LCA-2.5PTFE) with the associated RadSen-2 system. Accurate and identical positioning of the optical fibers on each IGBT die surfaces was ensured using a 3D printed holder (Figure 1a).

2. A second batch was prepared to generate two samples from a same power module for microstructural analysis in a SEM (Scanning Electron Microscopy): one heat treated sample and one as-delivered sample. As a result, the wirebond microstructure comparison will be based on IGBT dies and bonds produced with the same process conditions and bonding parameters. For this sample, the baseplate of the power module was cut to thermally decouple both IGBT dies. To force a large thermal gradient, one side of the power module was attached to a cold plate (at 15°C) and the other side, to be thermally treated, was kept in air, as shown in Fig. 1b. A low current of 7A was then injected in a desaturated IGBT at 5.6V of V_{ge} . The voltage across the IGBT was then around 17.8V, generating 124W of power dissipation and a junction temperature of 165°C, as measured with the optical fiber-based infrared sensor. The non-treated power device junction temperature was measured at 35°C. The treatment was applied for 91 hours. No significant modification was observed visually on the power module after treatment.

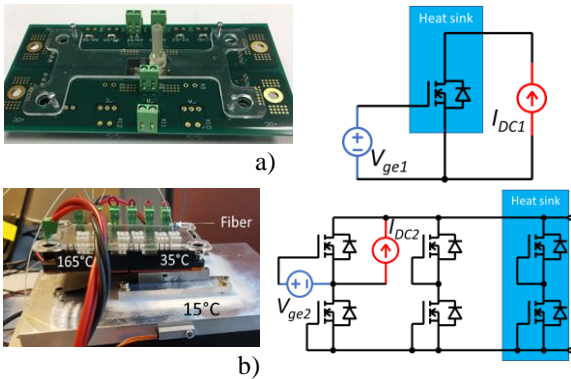

Fig. 1. Heat treatment for power modules a) with high current b) with desaturated IGBT

Overall, 4 power modules were prepared. The first 3 were thermally treated with the first method at 165°C/96hours and then power cycled. The 4th power module was prepared following the second method (heat treated die: 165°C/91hours, non-treated die: 35°C/91hours). 3 other non-treated (as-delivered) power IGBT were taken for reference and power cycled with the first 3 heat-treated power IGBTs.

2.2 Power cycling tests

The $T_j(V_{ce})$ dependency of the power modules was calibrated and the power modules were power cycled with a cyclic direct current test bench under the following conditions: $\Delta T_j \approx 90K$, $t_{on} = 3s$, and $T_{jmin} = 45^\circ C$. The individual ΔT_j was ranged from 88K to 102K while conducting a maximum of 150A.

The power cycling tests were stopped given the wire lift-off causing a V_{ce} increase of more than 5%. In general, the modules without the heat treatment had a smaller ΔT_j , but regardless, there was a significant improvement (more than 20%) in lifetime for the set of 3 IGBTs that underwent heat treatment, see Figure 2. The solid lines in Figure 2 represents a damage-law ($N_f = A \cdot \Delta T^\alpha$) with the coefficient α determined with other power cycling tests at various ΔT using the same non-treated power module but not shown in the figure and the coefficient A is determined to reduce the error from the power cycling data.

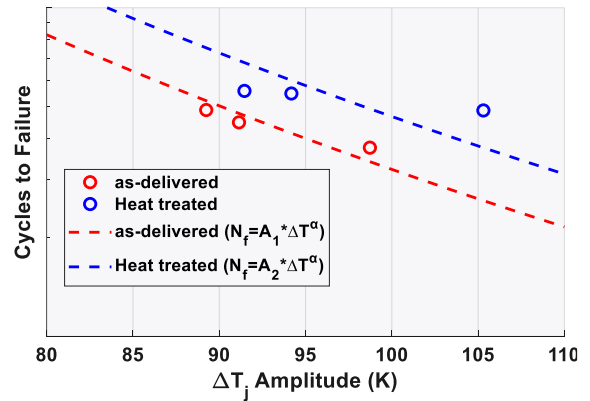

Fig 2. Lifetime comparison between reference power die and heat-treated power die.

While all the devices from the test failed in the same way, an interesting behavior is observed from the evolution of the on-state voltage during the lifetime of the untreated power dies against the treated power dies. As shown in Figure 3 with approximately the same ΔT_j value the first wire bond lift-off occurs later for the treated dies, and at a higher on-state voltage evolution (101.8% against 103.6%).

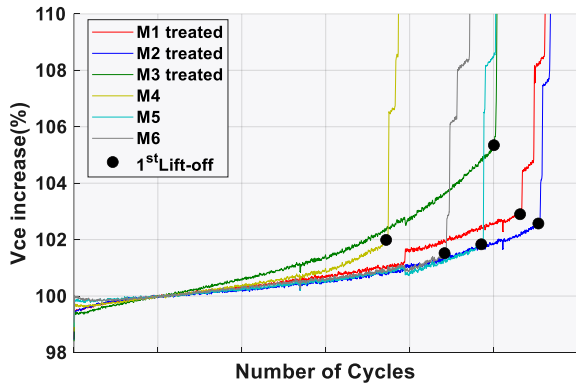

Fig. 3. Vce evolution during power cycling with the indication of the first wire bond lift-off

3. Micro-structure analysis

A typical procedure to determine the quality of the wire bond interconnection is to measure the strength of the interface between the bond wire and the metallization, usually through shear and pull tests [14]. Here, motivated by the lifetime increase induced by the thermal treatment, we focused on the microstructure of the wire bonding in order to understand the impact of the ultrasonic bonding process and the heat treatment.

3.1 Effect of bonding process on Al bonds microstructure

The Aluminum wire bond microstructure of an as-delivered module was analysed by Electron Back Scattering Diffraction (EBSD). At low magnification (figure 4a), three zones could be distinguished:

An 'unaffected' zone, where the microstructure of the wire is largely unchanged from wire drawing. Grains are preferentially oriented with their x-axis aligned with the wire direction as a result of the wire drawing process ('red grains').

A process-affected zone (below the black line), where grains show sub-structures/ sub-grain boundaries (dark lines within the grains under band contrast map). These sub-structures are dislocation networks which are formed because of the strong deformation during the bonding process. The material is likely hardened in this area.

A second region with refined grains, close to the metallization (below the white line). Previous works have shown that during power cycling the fatigue crack propagated preferentially at large angle grain boundaries in this zone.

Significant microstructure transformations occur during wire bonding process. High density of local misorientation is often correlated to the presence of

high concentration of geometrically necessary dislocations. Figure 4b shows the local misorientation of the as-delivered power module where each pixel orientation is compared to its neighbor. The dislocations formed during the wire bonding process merged to form sub-grain boundaries. Thus, the local mechanical properties are likely affected by this work hardening effect. The dislocations are defects that store energy in the material that can drive recrystallization and recovery phenomena.

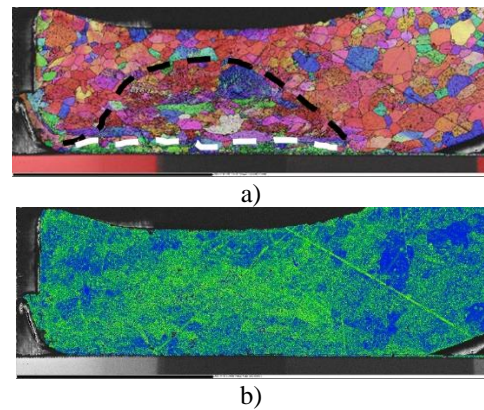

Fig. 4. As-processed wire bonding a) EBSD orientation map: projection on the x axis (red) b) local misorientation $>0.5^\circ$ colored in green. (scalebar: $500\mu\text{m}$)

3.2 Comparison with heat-treated power device

As shown in Figure 5a, the grain size significantly increased compared to Figure 4a due to the thermal treatment. The local misorientation also significantly decreases after thermal treatment. During thermal treatment regions with high dislocation density are 'consumed' by the recrystallized grains.

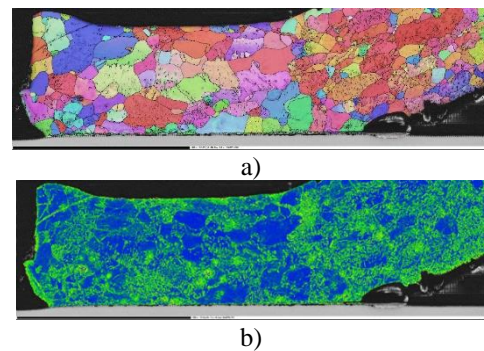

Fig. 5 Heat treated wire bonding a) EBSD orientation map: projection on the x axis (red) b) local misorientation $>0.5^\circ$ colored in green. (scalebar: $500\mu\text{m}$)

The mean grain size is larger for the treated power die in comparison to the 'as-delivered', as shown in

Figure 6. The analysis was conducted on the interface region (below the white line of Fig. 4a) and on the central position (below the black line of Fig. 4a). The mean equivalent diameter is respectively 3.82 μm and 8.54 μm for the non-treated and treated power module at the interface and 4.32 μm and 5.9 μm at the central wire position.

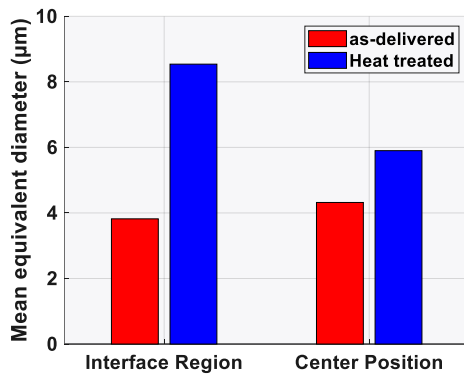

Fig. 6 Evolution of the grain size at the interface regions and at the center of the bond.

3.2.1 Bond interface before cycling

At higher magnification a continuous string of Aluminium oxides particles is observed at the position of the original metallization surface on the not treated chip. Comparatively the string of Aluminum oxide particles is more dispersed on the thermally treated chip, see Figure 7.

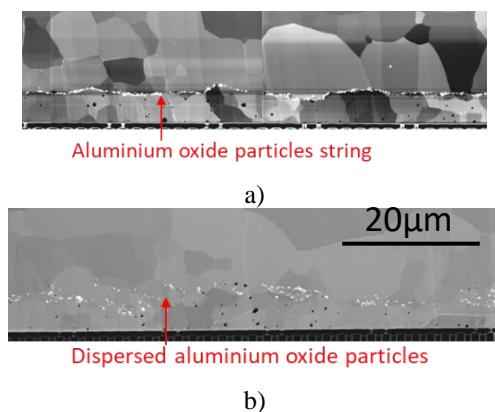

Fig. 7 High Magnification SEM analysis at the bond interface a) as-delivered b) heat treated

EBSM maps were acquired at high magnification at the wire-metallization interface to identify whether the grain structure of the metallization and the wire material merged, see Figure 8. A zone dynamically recrystallized during bonding can still be identified on the heat treated sample showing as 'green grains' on x -axis projection. Only at one point over the total analyzed interface length of 785 μm could be observed

a merging of the grains of the wire and the metallization (at the red arrow). This indicates that the process of thermal treatment can be improved more in the future. After thermal treatment some grains seem to have 'merged' between the wire material and the metallization showing that interdiffusion was more pronounced. Measured by the intercept method, the mean grain size is slightly larger for the treated chip in the metallization (4.6 μm versus 3.6 μm). In the wire material, 10 μm away from the interface, the same method leads to an average 9.0 μm grain size in the treated chip versus 6.2 μm in the non-treated one. EBSD measurements shown in Figure 6 show the same trend for grains in the wire, both in the plastic-affected region and away from it.

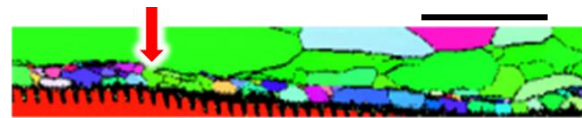

Fig. 8 High magnification EBSD analysis at the bond interface after thermal treatment. projection on the x axis (green)

3.2.2 Metallization-wire interface after cycling

At the end of life of the power modules, the fracture surfaces are similar for the as-delivered module and the heat-treated module. FIB cross-section through the remaining material shows that in both the treated and non-treated chips, the oxide particles are more dispersed than on the as-delivered chip, Figure 9. Fracture occurred at variable distance from the chip surface in both cases, sometimes below and above that aluminium oxide string.

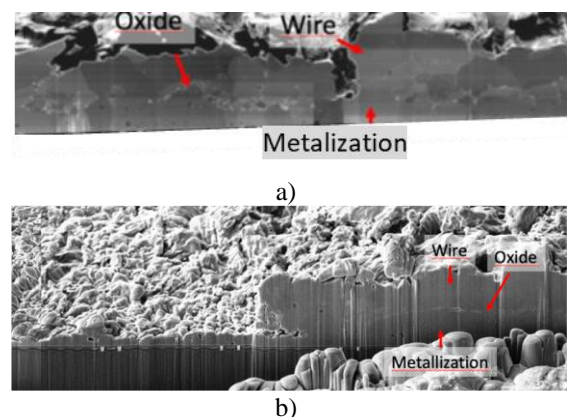

Fig. 9 SEM analysis of the wire-metallization interface after power cycling a) as-delivered b) thermally treated

4. Conclusions

The thermal treatment promoted interdiffusion between the metallization and wire and slight grain growth. The EBSD results so far are consistent with literature description of grain growth and recrystallization. However, it is not yet clear whether in our case the lifetime improvement is dominated by the effect of 1) wire-metallization interface stabilization or that of 2) ultrasonic bonding defect healing, relaxation in the material.

If 1) dominates: we should expect a significant effect of the initial thermal treatment on the crack path, the non-thermal treated dies should fracture more at the interface. The improvement is also expected to saturate. To test this hypothesis the effect of the thermal treatment on the crack propagation path should be studied in more details.

If 2) dominates: heat treatment by applying a temperature step should have a cumulative effect. Initial annealing should remove the damage in the ultrasonic process affected zone ('one-time' effect). This was visible by comparing large area EBSD analysis before and after initial annealing.

Periodic heat treatment during PC cycling may also relax the damages induced by cyclic plasticity and creep and suggest a new domain of repairable wire bonded power modules. The thermal control techniques [15] are good candidates for heat treatment for on-line applications.

Finally, the heat treatment conditions were not optimized, as shown by the remaining dynamically recrystallized grains that still visible after treatment) and merit to be optimized to further extend the lifetime of a power module. Furthermore, investigations on different power cycling conditions are necessary to validate the approach for a product application.

5. Acknowledgement

Thank you ELEMCA, Toulouse-FR, that conducted the low magnification SEM-EBSD analysis.

References

- [1] P. Agyakwa, L. Yang, E. Arjmand and e. al., "Damage Evolution in Al Wire Bonds Subjected to a Junction Temperature Fluctuation of 30 K," *Journal of Elec Materi* 45, p. 3659–3672, 2016.
- [2] N. Dornic, "Élaboration et comparaison de deux modèles de durée de vie des fils d'interconnexion des modules de puissance, l'un basé sur les déformations et l'autre sur les dégradations," PhD thesis, 2019.
- [3] P. Agyakwa, M. Corfield, J. L. L. Yang, V. Marques and C. Johnson, "Microstructural evolution of ultrasonically bonded high purity Al wire during extended range thermal cycling," *Microelectronics Reliability*, vol. 51, no. 2, pp. 406-415, 2011.
- [4] R. Ruffilli, M. Berkani, P. Dupuy and S. Lefebvre, "In-depth investigation of metallization aging in power MOSFETs," *Microelectronics Reliability*, vol. 55, no. 9-10, pp. 1966-1970, 2015.
- [5] R. Ruffilli, M. Berkani, P. Dupuy, S. Lefebvre, Y. Weber, B. Warot-Fonrose and e. al., "Aluminum metallization and wire bonding aging in power MOSFET modules," *Materials Today: Proceedings*, vol. 5, no. 6, pp. 14641-14651, 2018.
- [6] M. Ciappa, "Selected failure mechanisms of modern power modules," *Microelectronics Reliability*, vol. 42, no. 4-5, pp. 653-667, 2002.
- [7] R. Ruffilli, "Fatigue mechanisms in Al-based metallizations in power MOSFETs," PhD thesis, 2018.
- [8] E. Arjmand, P. A. Agyakwa, M. R. Corfield, J. Li and C. M. Johnson, "Predicting Lifetime of Thick Al Wire Bonds Using Signals Obtained From Ultrasonic Generator," *IEEE Transactions on Components, Packaging and Manufacturing Technology*, vol. 6, no. 5, pp. 814-821, May 2016.
- [9] W. Loh, M. Corfield, S. H. H. Lu, T. Tilford and .. C. M. Johnson, "Wire Bond Reliability for Power Electronic Modules - Effect of Bonding Temperature," *International Conference on Thermal, Mechanical and Multi-Physics Simulation Experiments in Microelectronics and Micro-Systems*, pp. 1-6, 2007.
- [10] J. M. Nowful, S. C. Lok and S. -. R. Lee, "Effects of plasma cleaning on the reliability of wire bonding," *Advances in Electronic Materials and Packaging*, pp. 39-43, 2001.
- [11] T. Matsunaga and Y. Uegai, "Thermal Fatigue Life Evaluation of Aluminum Wire Bonds," *st Electronic Systemintegration Technology Conference*, pp. 726-731, 2006.
- [12] Y. Wu, G. Thome and T. Savage, "Reliability Improvement of Aluminum Wirebonds in High-Power IGBT Modules," *MRS Online Proceedings Library* 445, pp. 191-196, 1996.
- [13] Y. K. Yun and E. P. Leng, "Cu wire bond reliability improvement through focused heat treatment after bonding," *33rd IEEE/CPMT International Electronics Manufacturing Technology Conference (IEMT)*, pp. 1-7, 2008.
- [14] J. Goehre, M. Schneider-Ramelow, U. Geißler and K. Lang, "Interface degradation of Al heavy wire bonds on power semiconductors during active power cycling measured by the shear test," *6th International Conference on Integrated Power Electronics Systems*, pp. 1-6, 2010.
- [15] D. A. Murdock, J. E. R. Torres, J. J. Connors and R. D. Lorenz, "Active Thermal Control of Power Electronic Modules," *38th IAS Annual Meeting on Conference Record of the Industry Applications Conference*, vol. 3, pp. 1511-1515, 2003.