

« Energy consumption and quality-productivity compromise in rubber molding »

Julien LAUNAY, Nadine ALLANIC, Pierre MOUSSEAU, Alain SARDA, Rémi DETERRE

Nantes University – GEPEA

e-RUBBERCON 2020
Paris **11-12 FEBRUARY 2021**

GEPEA-Nantes University

- GEPEA lab. activities
 - Bioressources
 - Eco-Technologies
- GEPEA-Nantes University research team
 - Polymer process optimization
 - Energy consumption reduction
- Among various project in polymer processing
We developed rubber curing optimization

Rubber mold optimization and energy consumption

- Energy consumption Industry challenge
 - According to new regulations
 - Cost saving
- Rubber industry challenge
 - Big energy consumption
 - Control part quality and process productivity

Quality – Productivity compromise optimization

- Our previous works
 - Rubber Process thermal control
 - Optimization of quality and process compromise
- Optimization procedure
 - Thermal control of process
 - Choice of state of cure target
 - Calculation of process limit conditions in order to get the desired state of cure

Optimization methodology

- Experiment



- Simulation

- Thermal

- Kinetics

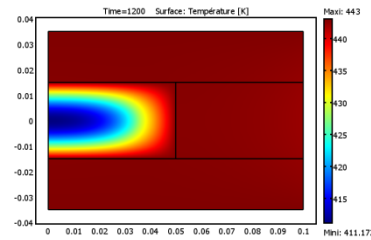

thermique

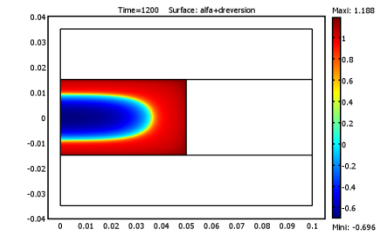

cinétique

- Optimization

- Alpha Level target
- Homogeneous state of cure
- Under process acceptable conditions

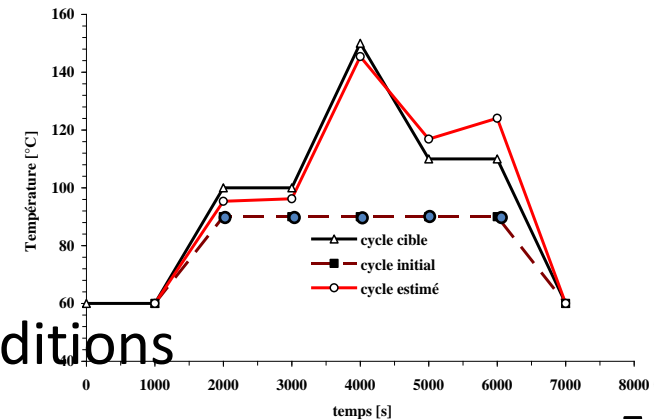

Quality – Productivity compromise optimization

- Thermal controlled device
 - Mold thermal control
- Production of Iso-alpha thick rubber parts

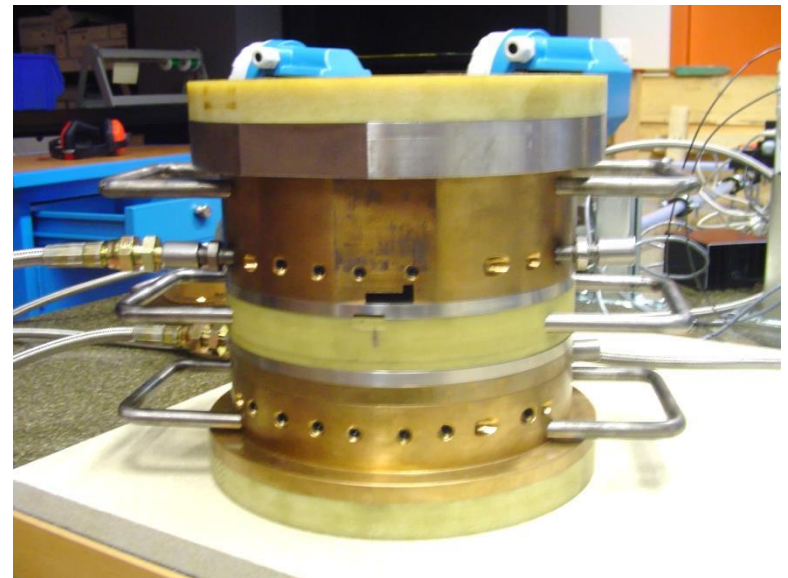

Thermal controlled tool

- Mold details

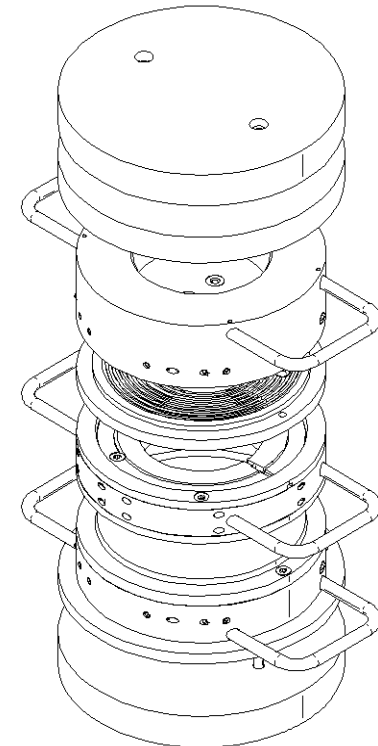
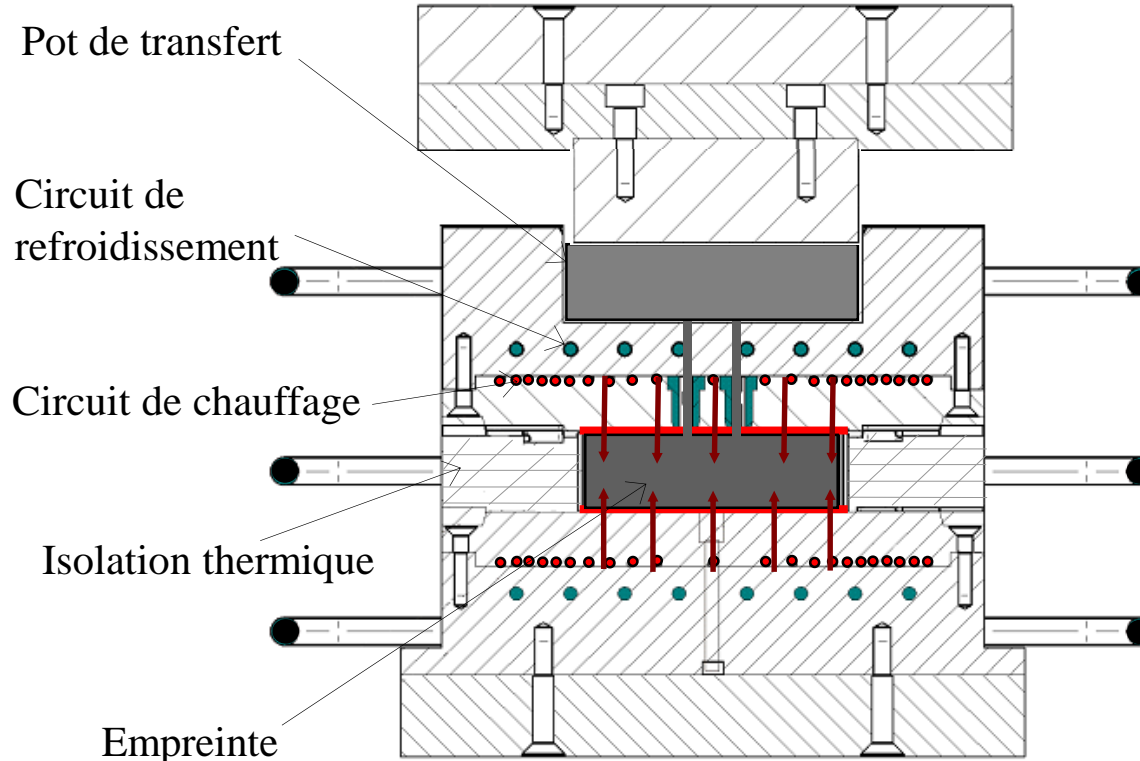

Alpha controlled rubber parts

- Control of alpha gradient
 - Thick parts
 - Vulcanization frontier location

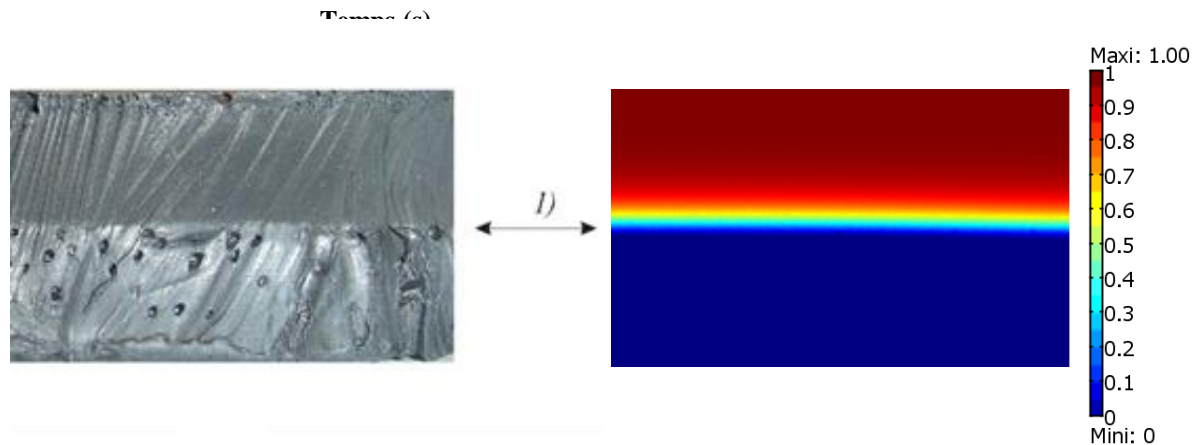
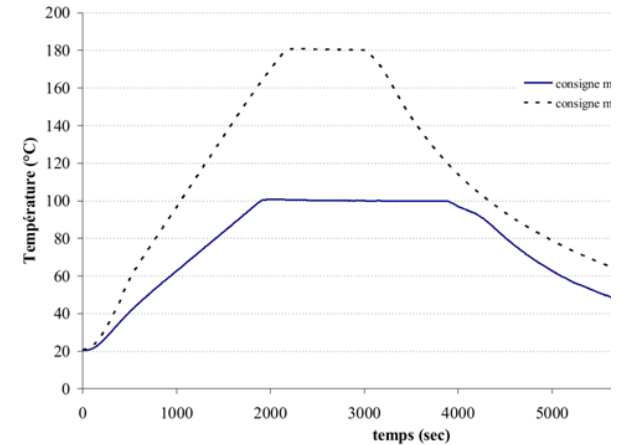

Iso-alpha part production

- Optimized molding versus traditional molding

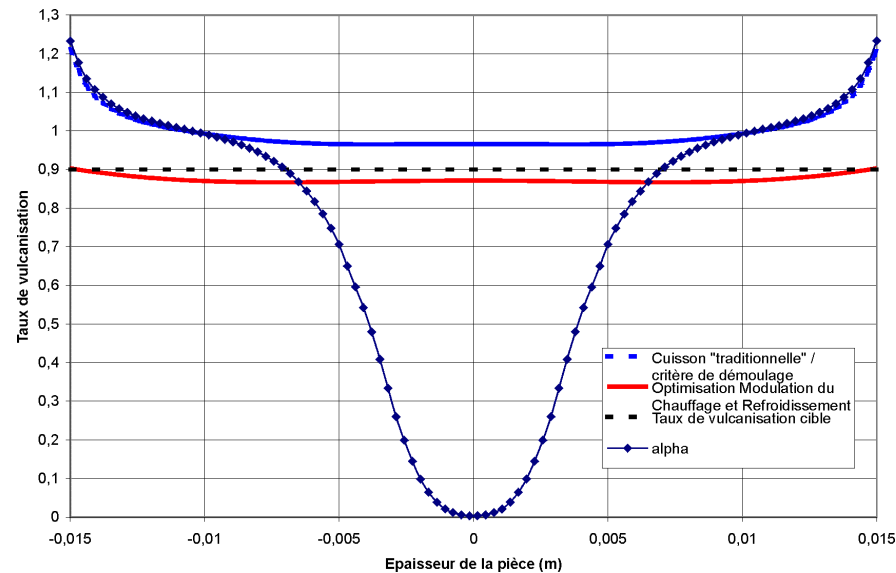

Quality – Productivity

- Productivity P algorithm

$$+\delta p = -\frac{\delta t'}{t'} \quad P = A \operatorname{Ln}\left(\frac{1}{t'}\right)$$

- Quality Q algorithm

$$+\delta q = -\frac{\delta\left(\frac{\delta\alpha}{\alpha}\right)}{\frac{\delta\alpha}{\alpha}} \quad Q = B \operatorname{Ln}\left(\frac{1}{\frac{\delta\alpha}{\alpha}}\right)$$

- P - Q Compromise

– PerformanceIndex = PQ

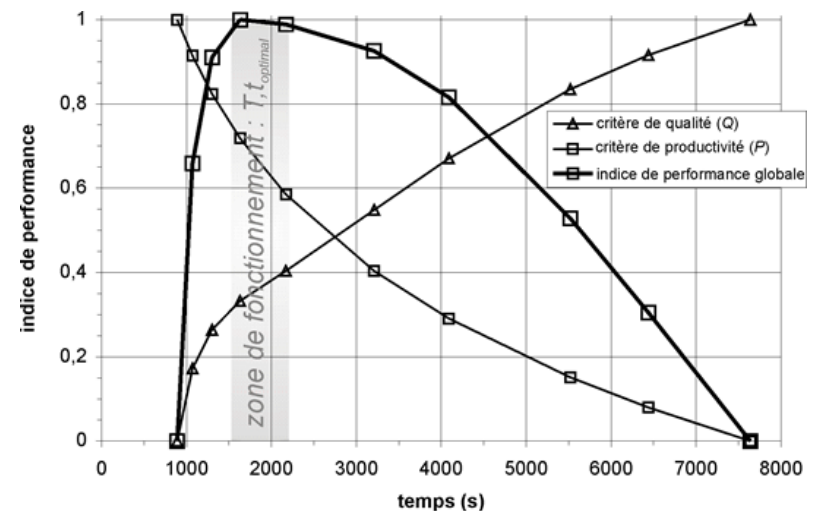

Energy consumption measurements

- Energy consumption measured during P - Q optimize production cycles
- Measurement equipment



Mold and measurement device

- Material
 - EPDM Sulfur accelerated Rubber compound
- Injection machine
 - REP VYZ...
- Mold
 - Part weight
 - Number of cavities
- Process settings
 - Temperatures
 - Pressures
 - Cycle time



Global energy consumption

- Versus the number of production cycles
- Proportionality
Energy consumption versus Number of cycles
 - except for the low number of cycles

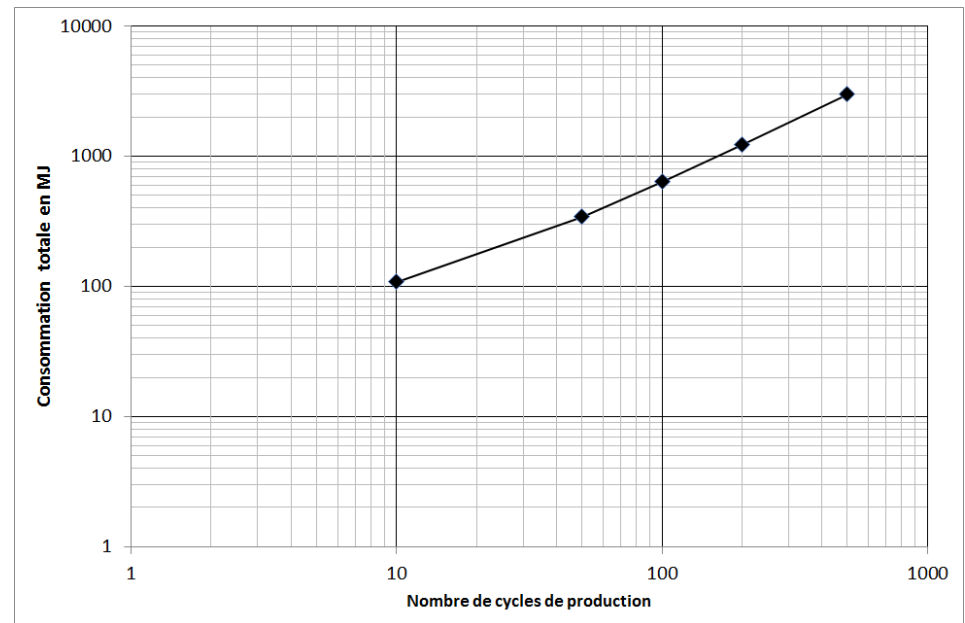

Energy consumption per cycle

- Energy consumption related to one cycle

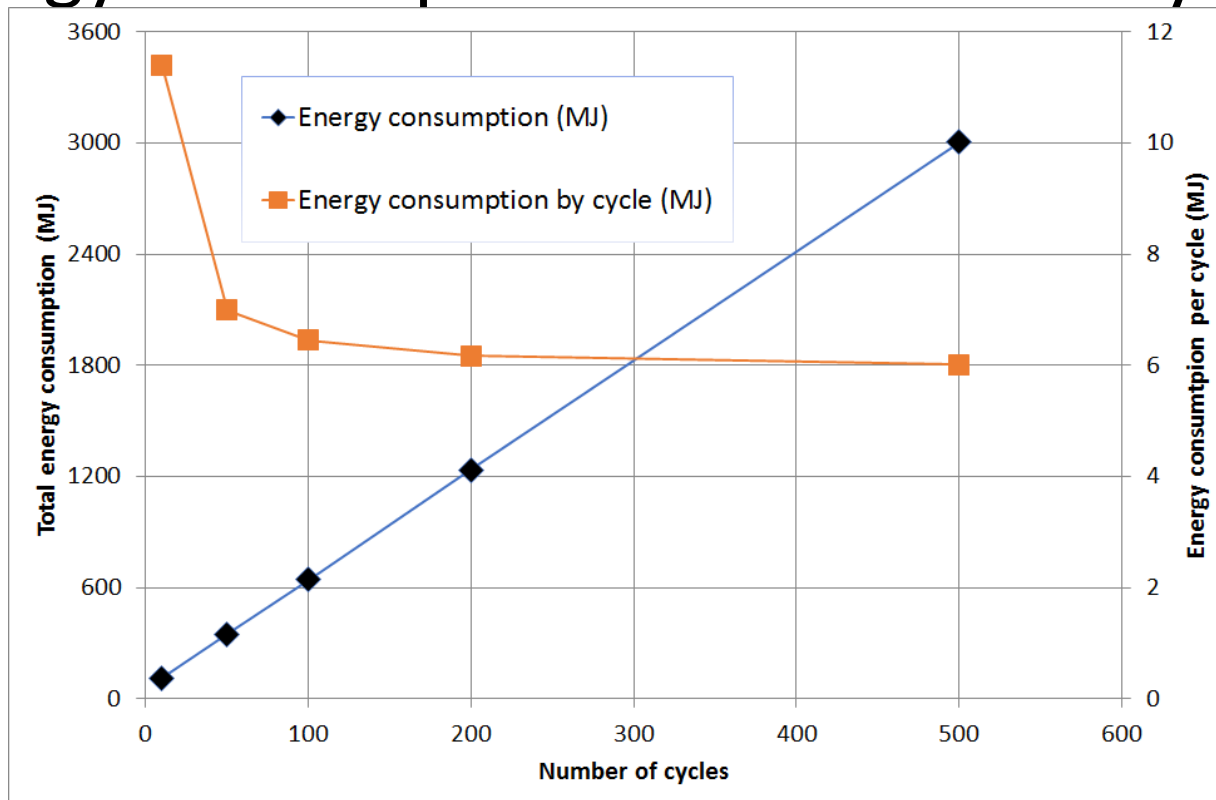

Energy consumption items

- The main items are
 - Machine
 - Tool
- The lower items are
 - Machine energy balance setting
 - Tool energy setting

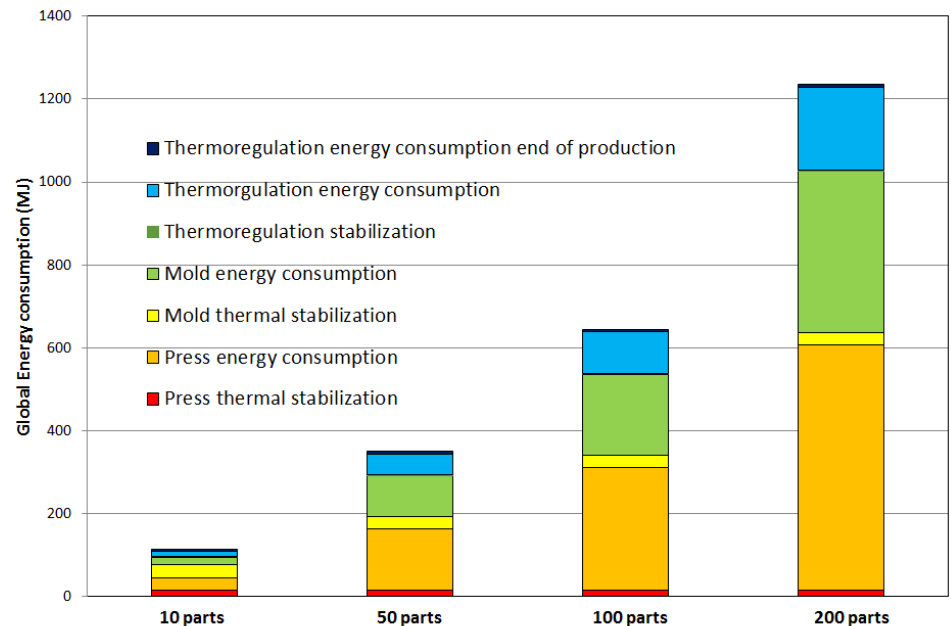

Relative energy consumption items

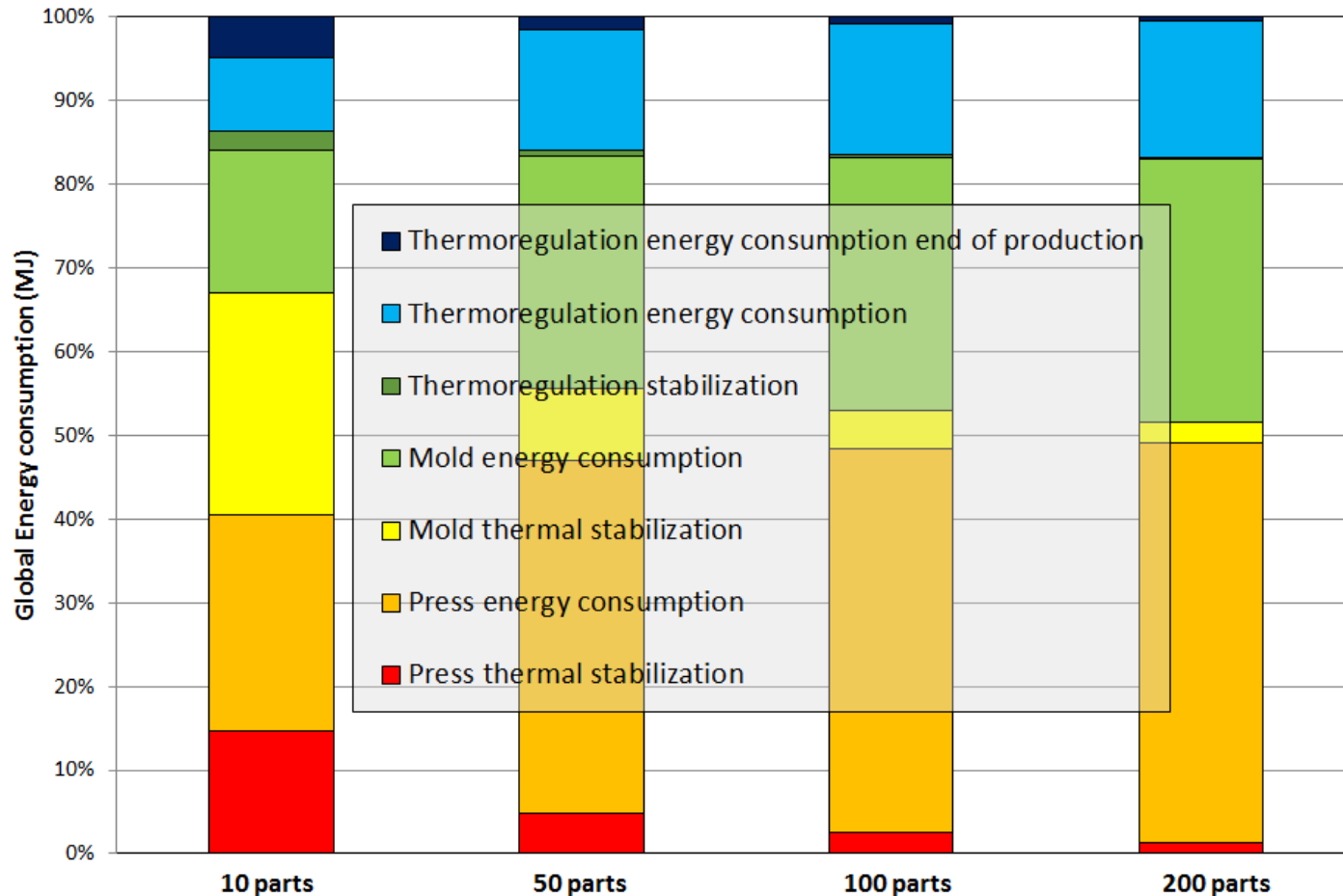



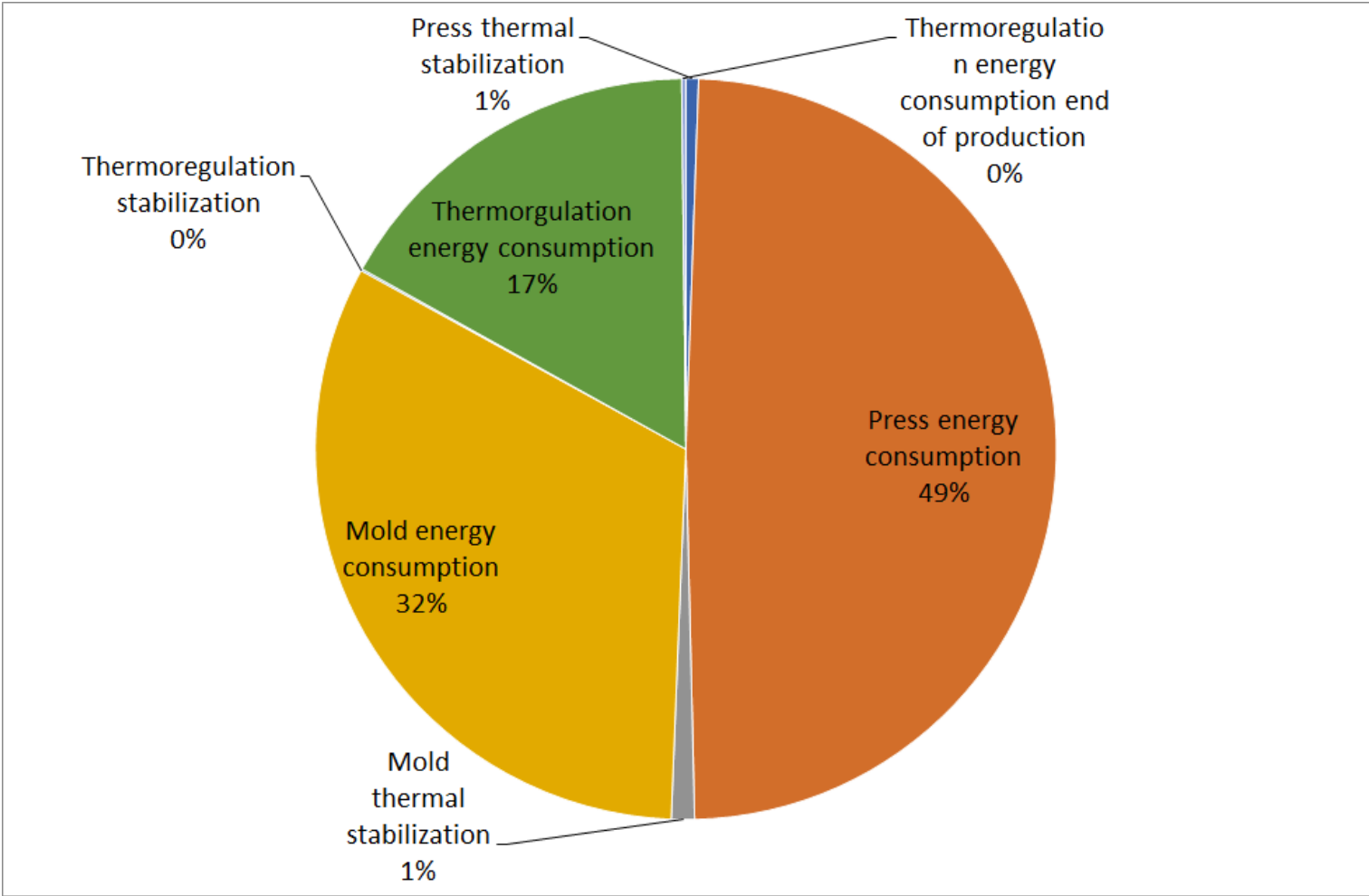

Relative energy consumption items



Tool energy balance

- Energy balance

- 
 - Loss towards press plates
- 
 - Convection during mold opening
- 
 - Convection mold closed
- 
 - Rubber heating

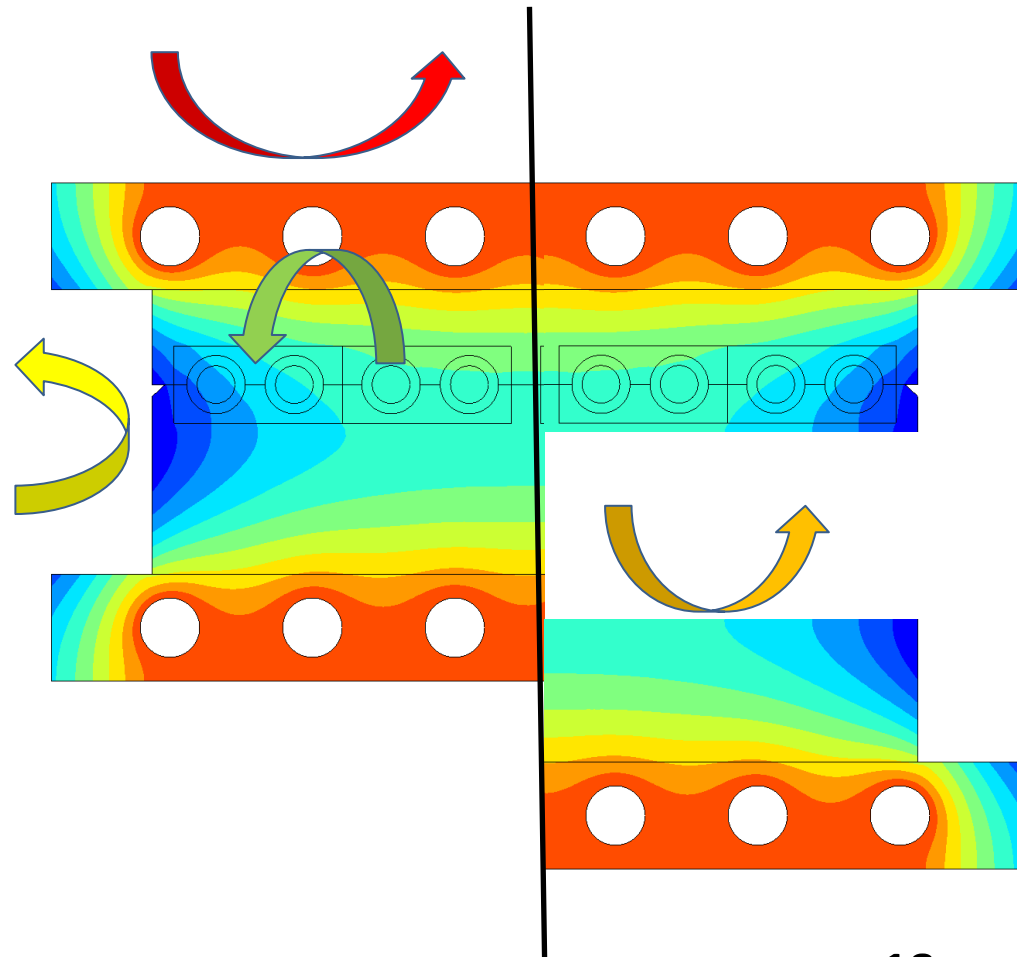

Mold energy balance

- 66% loss towards the press plates
- 14% convection during opening
- 12% convection mold closed
- Less than 10% useful for vulcanization process

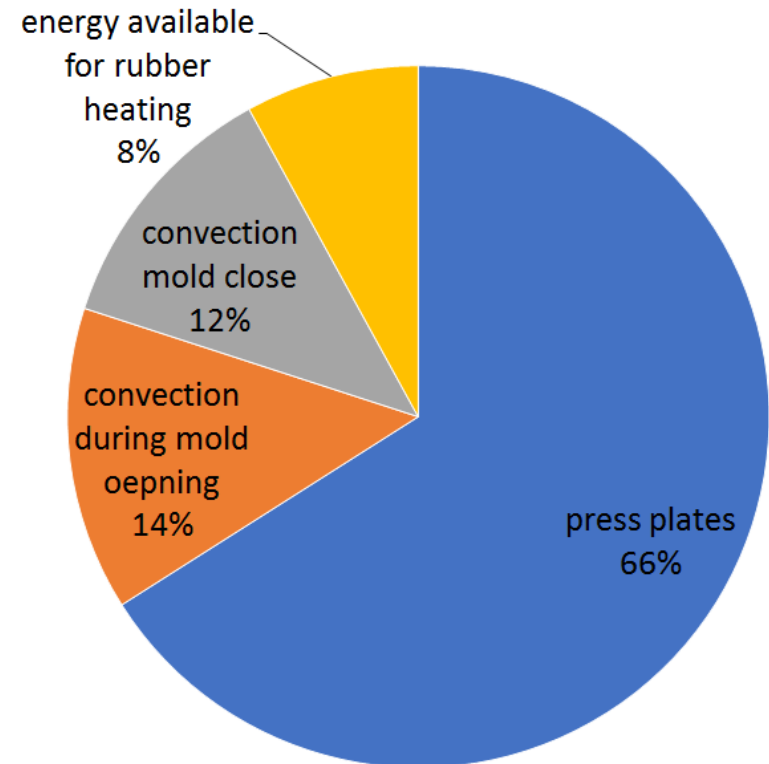

Conclusion

- Less than 3% of the global energy consumption is available for the rubber temperature increase and cure
- There is many things to do
 - Press energy savings (new hydraulic devices, electric machinery...)
 - Press insulation improvement
 - Tool thermal regulation improvement