



**HAL**  
open science

## Use of the vibroacoustic transfer function built for the prediction of noise radiated to other vibrational states

Abbassia Derouiche, Nacer Hamzaoui, Belaid Bouzouane, Abdelhamid Miloudi

### ► To cite this version:

Abbassia Derouiche, Nacer Hamzaoui, Belaid Bouzouane, Abdelhamid Miloudi. Use of the vibroacoustic transfer function built for the prediction of noise radiated to other vibrational states. CFM 2015 - 22ème Congrès Français de Mécanique, Aug 2015, Lyon, France. hal-03446554

**HAL Id: hal-03446554**

**<https://hal.science/hal-03446554>**

Submitted on 24 Nov 2021

**HAL** is a multi-disciplinary open access archive for the deposit and dissemination of scientific research documents, whether they are published or not. The documents may come from teaching and research institutions in France or abroad, or from public or private research centers.

L'archive ouverte pluridisciplinaire **HAL**, est destinée au dépôt et à la diffusion de documents scientifiques de niveau recherche, publiés ou non, émanant des établissements d'enseignement et de recherche français ou étrangers, des laboratoires publics ou privés.

# Use of the Vibroacoustic Transfer Function Built for the Prediction of Noise Radiated to other Vibrational States

A. DEROUCHE<sup>a</sup>, N. HAMZAOU<sup>b</sup>, B. BOUZOUANE<sup>a</sup> and A.H. Miloudi<sup>a</sup>

a. Laboratoire de Mécanique Avancée, FGM&GP, USTHB, BP 32 El Alia,  
Bab Ezzouar, Algérie, derouichea@gmail.com

b. Laboratoire Vibrations Acoustique, INSA Lyon, France,  
nacer.hamzaoui@insa-lyon.fr

...

## Résumé :

*Le but est d'utiliser la fonction de transfert vibroacoustique  $G$  construite numériquement pour un état vibratoire afin de prédire le rayonnement acoustique de la transmission par engrenages pour d'autres états d'excitation vibratoire. Cette méthode d'approche basée sur le modèle de C. MARQUIS, permet à partir de quelques mesures accessibles de vitesses vibratoires normales relevées sur la transmission de reproduire le champ acoustique rayonné dans son environnement pour un état vibratoire différent, des interpolations de type local ou global sont faites sur les valeurs de  $G$ . Ce champ exprimé en niveaux de pression et de puissance acoustiques peut être prédit aux mêmes points ou en d'autres points du maillage acoustique. Les constatations et les remarques nous permettent de dire que cette fonction de Green  $G$  construite numériquement pour un état vibratoire a contribué à prédire de manière confortable le rayonnement pour d'autres états vibratoires, elle a bien gardé son rôle de fonction de transfert vibroacoustique. Elle servira pour le suivi, le diagnostic et la maintenance des transmissions par engrenages.*

## Abstract :

*The aim is to use the vibroacoustic transfer function  $G$  constructed numerically for a vibrational state to predict the acoustic radiation of the gear transmission for other vibrational excitation states. This approach method based on C. MARQUIS's model allows from some measures available normal vibrational velocities measured on the transmission to reproduce the acoustic field radiated in its environment for a different vibrational state, local or global interpolation types are made on the values of  $G$ . This field expressed in acoustic pressure and power levels can be predicted at the same points or on other points of the acoustic meshing. The findings and observations allow us to say that the Green function  $G$  constructed digitally for a certain vibrational state has comfortably predicted the acoustic radiation for others vibrational states; it has kept its role of vibroacoustic transfer function. It will be used for monitoring, diagnosis and maintenance of gear drives.*

**Key words:** acoustic radiation, gears, Green function, vibroacoustic function transfer, noise sources.

# 1 Introduction

The prediction of acoustic radiation gear drives is rather complex and still poorly resolved despite the immense research work on this subject. The authors are unanimous in saying that only a global and profound study that takes into account all the components of the transmission can predict the vibratory and acoustic response of the transmission. This study involves in all cases, the use of structure calculation codes based on the finite element method (FEM) for the vibration behavior and computational codes based on the boundary element method (BEM) to predict the acoustic behavior. For these methods, the real difficulty lies in determining the Green's function satisfying the Helmholtz equation, the condition of Sommerfeld and the boundary conditions on the vibrating surface.

Among the literature on the reduction of noise and vibration gear drives, we can cite the work of Opitz [1] whose results are come from large experiments specifying the sound pressure level emitted by reducers and multipliers gears. As for Houser [2], he drove an excellent course on noise gear offered by Gear Dynamics of Ohio State University and Gear Noise Research Laboratory. For Seybert et al [3], they used the modal data housing experimentally measured by finite boundary elements (BEM) for calculating the pressure and the acoustic intensity on the surface of the housing, and the acoustic radiation efficiency of each mode. For Sabot and Perret-Liaudet [4], they calculated the noise radiated by the casing of the gearbox using the Rayleigh integral formulation, in which the acceleration response of the associated housing was made by finite elements. Despite the simplicity of their model, their results have provided a better understanding of the characteristics of acoustic radiation of gear transmission systems. Inverse methods began to be used on sources of irregular geometries in the mid-90s and that in order to overcome the geometric limits of near-field acoustic holography (NAH) whose bases and developments were introduced in the early 80s by Maynard Williams [5]. The training paths invented by Billingsley and Kinns [6] allow from a linear antenna constituted of microphonic sensors regularly distributed to calculate the sound pressure emitted in a particular direction. It is widely used in transmission systems, and acts as a spatial filter for each desired direction of interest, the gain will be maximum and attenuates signals in undesired directions (interference). The methods based on models and which require the inversion of transfer or propagation matrices include the method of inverse boundary element (IBEM) and the method of equivalent sources (ESM). IBEM was used for the direct problem by Veronesi and Maynard [7] or in an indirect way by Schuhmacher et al 2003 [8], whenever the identification technique having a great potential in practice called inverse frequency response function (IFRF), it was introduced and developed by Kim [9] and Veronesi. [7].

The position of our problem and the proposed model were made following the fact that for these methods, the relationship between the vibrating surface and the sound field is achieved through the Green's function constructed analytically from the boundary conditions of the problem. The analytical construction of the Green's function requires either the assumption of a acoustic propagation in fluid medium infinite or semi-infinite (assumption made in most of the studies) or knowledge of boundary conditions on the surfaces defining the finite environment wherein is the radiating structure [10]. Thus, the difficulty of constructing analytically Green's function of a gear transmission, and classic models based on FEM and BEM judged to be too heavy led us to use the model proposed by C. Marquis [10].

Our work will focus on the use of the Green's function  $G$  constructed digitally to vibratory state from complex vibratory measurements taken at accessible points of the gear transmission and complex sound pressures considered in some points of the surrounding field [11,12]. This transfer function vibroacoustics discreet built will be used to predict the acoustic radiation for other vibrational excitation states which will be expressed in sound pressure levels and power  $L_p$  and  $L_w$ . The

calculations will be made to the same listens points of the acoustic mesh as well as the other points that do not belong to the acoustic mesh by local interpolations on the numerical values of  $G$ .

## 2 Overview on the model of acoustic problem

The digital construction of the vibroacoustic transfer function is made from experimental data collected at certain points point sources distributed over the gear transmission giving the complex vibration velocities and points of space surrounding the gear transmission characterizing the given radiated field by complex acoustic pressure. This vibroacoustic transfer function will be used for prediction of the noise radiated by the transmission for any speed hence for any vibratory condition.

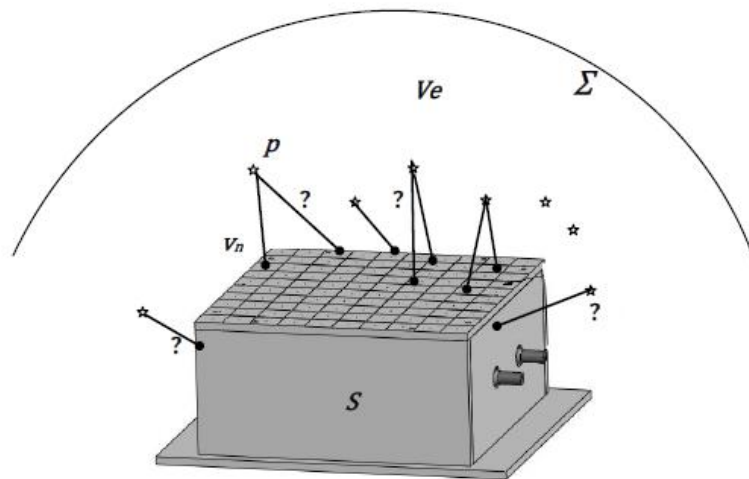


Fig. 1. Model of the radiation of the gear transmission [11]

### 2.1 Approach and formulation of acoustic radiation

In what follows, the theoretical formulation of the model in Figure 1 of the external acoustic problem will be briefly described. The gear transmission whose surface is  $S$  vibrates in the fluid field  $V_e$ ; it is delimited by the  $\Sigma$  surface outside. In the absence of any other external source, the sound pressure represented by the acoustic field must satisfy the homogeneous Helmholtz differential equation:

$$\Delta P(M) + k^2 P(M) = 0 \quad M \in V_e \quad (1)$$

$\Delta$  Laplace operator,  $k = \omega/c$  the wave number,  $\omega$  the excitation pulse and  $c$  is the speed of the waves in the medium  $V_e$ . The conditions on  $S$  and  $\Sigma$  limits are of the inhomogeneous Neumann.

The difficulties encountered in the computation of the vibrational velocities on the entire outer surface  $\Sigma$ , the calculation of wall pressure on  $S$  and  $\Sigma$  and particularly the problem of knowledge of the Green's function of our problem is not at all easy. The introduction of assumptions and approximations were necessary to gain access to the Green's function of the problem posed. Thus, the construction process of the vibroacoustic transfer function  $G$  according to C. Marquis [10] is to consider two problems that follow.

We assume in the first known, the acoustic pressure radiated into the surrounding environment  $V_e$ , and secondly we introduce a fictitious structure vibrating surface  $S'$  which is identical to the surface  $S$

with the same distribution point sources radiating in free field the same sound field radiated by the vibrating structure in its real environment.

In the first case, we assume that the Green's function  $G$  satisfies the boundary conditions on  $S$  and  $\Sigma$  quasi homogeneous Neumann type, that the normal vibratory velocities on  $\Sigma$  are negligible compared to those that occur on  $S$ . These simplifications allow rewriting of the acoustic pressure at any point  $M$  of  $V_e$ , it will be approached by:

$$P(M) = \iint_S j\omega \rho v_n(M_0) G(M, M_0) dS_{M_0} \quad M \in V_e, M_0 \in S \quad (2)$$

$\rho$  is the density of the acoustic medium,  $v_n$  is the normal vibrational velocity to  $M_0$ , this point belongs to the surface  $S$ .

In the second case, we assign to each source point  $M_0$  a density function  $\mu$ . The acoustic field generated by  $S'$  in free space which is identical to the one created by  $S$  in its local, it is accessible by the following formulation of the potential single-layer-type:

$$P(M) = \iint_{S'} \mu(M_0) g(M, M_0) dS'_{M_0} \quad M \in V_e, M_0 \in S' \quad (3)$$

Where  $g(M, M_0) = \frac{e^{-jkr}}{4\pi r}$  is the Green function in the infinite space solution of the Helmholtz equation in a free environment and verifying the condition of Sommerfeld to infinity,  $r$  is the distance between the source point and the listening point. In addition, this function does not have to satisfy the boundary conditions on  $S$ . We can determine the density  $\mu$  for each source point  $M_0$  from the sound pressure around the surface  $S'$ . We thus from the actual system and the system fictitious the same pressure field defined by:

$$P(M) = \iint_S j\omega \rho v_n(M_0) G(M, M_0) dS_{M_0} \approx \iint_{S'} \mu(M_0) g(M, M_0) dS'_{M_0} \quad (4)$$

The unknown in this equation is  $G(M, M_0)$  because  $\mu$  is obtained by solving the equation (3). The expression (4) is the basic model of the problem, which allows access to the vibroacoustic transfer function  $G(M, M_0)$ .

The  $\mu$  density function assigned to the source points  $M_{0h}$  is determined digitally from the measured pressure to the  $np$  points of the acoustic meshing and, with the discretization of the surface  $S'$ , the integral equation is expressed as a system of linear equations. Each system equation takes the following form:

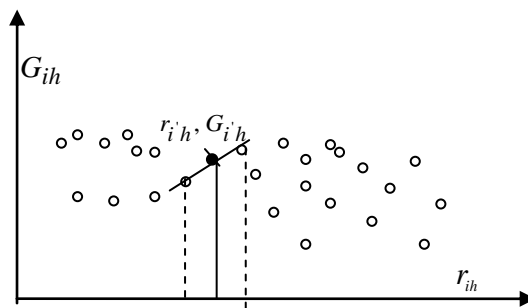
$$\forall i \in [1, np] \quad P_i \approx \sum_{h=1}^{mv} \mu_h g_{ih} \Delta S'_h \quad (5)$$

## 2.2 Use of the $G$ function for the noise prediction

The  $G$  function is known between each source point and listening points. For new vibratory acquisitions, the calculation of the pressure is possible only for listening points already chosen; an approach has been developed to overcome this disadvantage. For the calculation of the Green's function for listening points other than the acoustic mesh, an interpolation is made on the different

values of  $G$ . The latter being defined by the pair  $(r_{ih}, G_{ih})$ , its value for a point source  $h$  is characterized by its distance from the listening point  $i$ ,  $G_{ih}$ . For  $i'$ , a new listening point  $M'_i$ ,  $G_{i'h}$  is numerically calculated by local or global approach.

The local approach used in this case of Figure 2, is to linearly interpolate the value of  $G_{ih}$  in all the  $G_{ih}$  ( $i \in [1, np]$ ) values of a source  $h$ . The operation is repeated for each source point  $h$  and we get all the values of  $G_{i'h}$ ,  $h$  from 1 to  $mv$ . The chosen interpolation method is performed using the Lagrange polynomials of the first degree.



**Fig. 2.** Local approach for  $G$  [10]

For other vibrational state acquired at source points  $M_{0h}$  ( $h \in [1, mv]$ ) of the surface  $S$  and with the same integral calculation approximations, the expression of the sound pressure in the one or more of  $M'_i$  points is given by:

$$P_i = \sum_{h=1}^{mv} j\omega \rho v_{nh} G_{ih} \Delta S_h \quad (6)$$

The prediction is either local with pressure in decibels of  $P_i$  calculated by one or more points  $M'_i$ , or global by determining the active acoustic power.

The active power is obtained by calculation of the normal flow of the active acoustic intensity throughout a control surface  $S_c$  around the vibrating structure and its expression is:

$$W = \iint_{S_c} \vec{I} \cdot \vec{n} \cdot dS_c \quad \text{où} \quad \vec{I} = \frac{1}{2} \text{Re} \{ P(M') \cdot \vec{u}^*(M') \} \quad (7)$$

$\vec{I}$  is the active acoustic intensity vector,  $\vec{n}$  is the unit vector normal to outer  $S_c$  and  $\vec{u}^*$  the conjugate complex vector of the acoustic particle velocity.

### 3 Application to the geared transmission

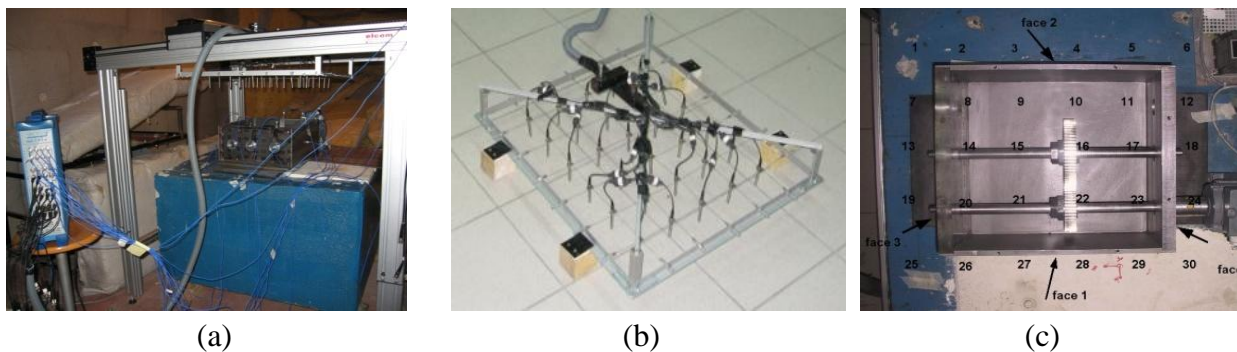
The experiments were undertaken at the Laboratory Vibration and Acoustics (LVA) INSA Lyon in a semi-anechoic chamber. The measurements were recorded by OROS 32 channels (OR38); it made rapid measures through its multi-function analysis and simultaneous recording. The data recorded by OROS are downloaded to NVGate front OROS to the PC, we recorded the time signals during these measures and we have exported them directly .mat in order to be post-process and analyze under MATLAB software.

### 3.1 Experimental test bench and acquisition system

The simplified gear transmission mechanism is made of a spur gear comprising a pair of teeth 45/65, as shown in Figure 3 (c). The main characteristics of this gear are given in Table 1. The wheels are full made of steel mounted on shafts of the same diameter equal to 0.02 m. The input shaft is connected to the motor by a flexible coupling. The shafts are guided in rotation by rolling bearings. The parallelepiped shape housing is of dimensions (0.4m\*0.35m\*0.16m) and a thickness of 0.025m except for the wall 5 (cover) which, it is to 0.005m. The casing is made of two materials, steel and Plexiglas, it have Young's modulus  $2.1 \cdot 10^{11} \text{N/m}^2$  and  $3.3 \cdot 10^9 \text{N/m}^2$ , a density of  $7800 \text{kg/m}^3$  and  $1190 \text{kg/m}^3$  and coefficient Poisson 0.3 and 0.37 respectively. The sides 3 and 5 are made of Plexiglas, others are made of steel.

**Table 1.** Main characteristics of the gear

	Pinion	wheel
Tooth number	45	65
Module (m)	0.002	0.002
Tooth width (m),	0.020	0.020
Base radius (m)	0.045	0.065
Pressure angle (deg)	20	20

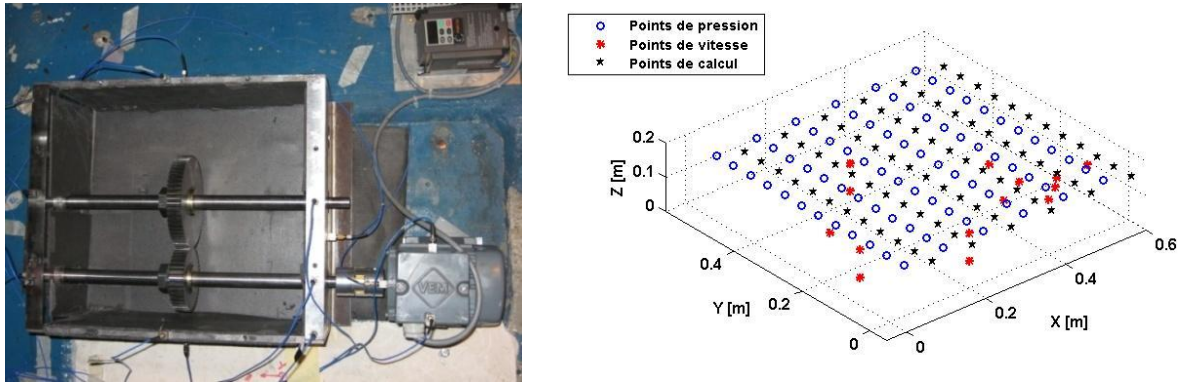


**Fig. 3.** (a): Experimental bench, Oros 32 channels in semi-anechoic room LVA, Lyon  
(b): Antenna composed of 30 microphones, (c): open mechanism [11]

#### 3.1.1 Prediction at the same points of the acoustic meshing

Figure 4 on the left is an example amongst the various configurations, showing the positioning of accelerometers on the housing, the motor and close to the bearings. On the right, the spatial representation of the problem shows the points of vibratory measurements in red on the transmission, blue points correspond to the position of the microphones on the hologram placed above the transmission, and the black prediction points are located on an imaginary plane parallel to the hologram.

The approximate method was applied to the prediction of noise radiated by transmission gears for the same given vibrational state; the results have been reported in [12]. Vibroacoustic transfer function is constructed for a given state; it will be used for predictive calculation of the acoustic radiation to other states of excitement at the same points and other points of the acoustic meshing using local interpolations on  $G$  values. Two cases of radiation transmission gears are considered, they correspond to two engine entry speeds equal to  $f_{m1}=30.1 \text{ Hz}$  and  $f_{m2}=41.1 \text{ Hz}$ .

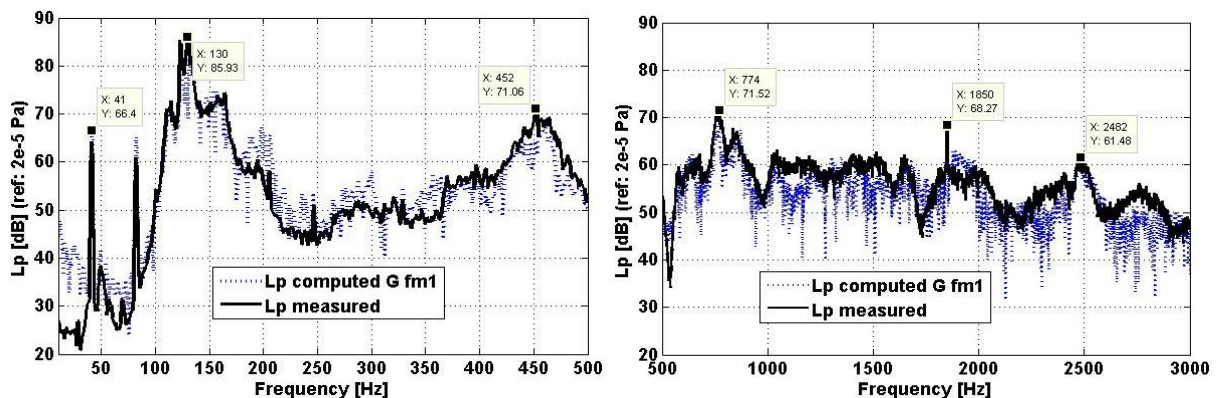


**Fig. 4.** Sensor positions on the housing, the motor and the bearings to the left  
 Spatial representation of the problem: acoustic meshing:  $np=npp=72$   
 Velocities (red), measured Pressures (blue) and calculated (black) to the right

We defer the results of prediction of the acoustic radiation of the geared transmission for an acoustic meshing with 72 microphones distributed over the hologram and the fictitious plane of calculation as shown in Figure 4 to the right. The calculations of acoustic pressure and power levels radiated by the transmission are performed on all the points of the fictitious meshing by our approximate method. We can also plot the cartographies representing the sound level from all points of the calculated fictitious plane and compare them with those measured by the hologram considered confounded in this case with the fictitious plane.

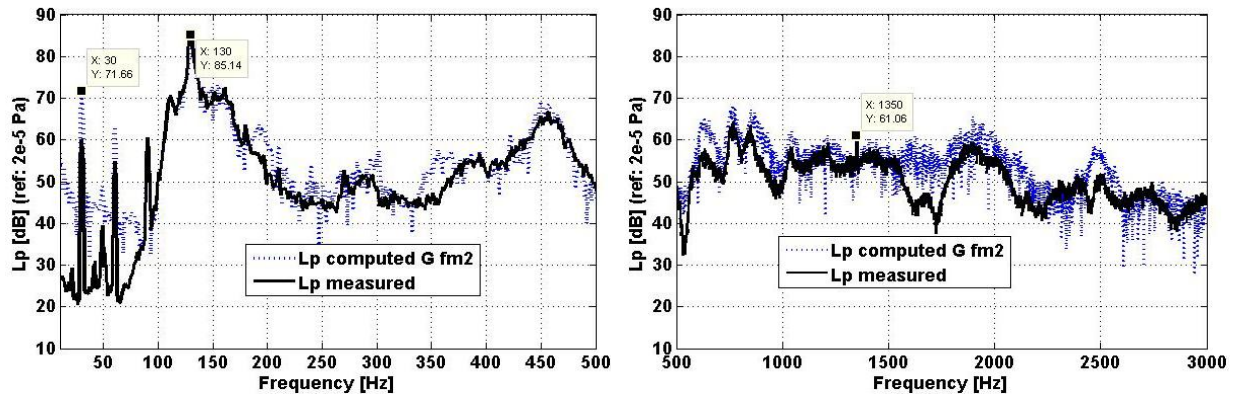
#### a. Calculation of the sound pressure level $L_p$

The calculation of the pressure at a point  $M'(0.05, 0.15, 0.20)$  of the surrounding field has been well approached as shown in both Figures 5 and 6 below. Vibroacoustic transfer function  $G$  was constructed at  $f_{m1}$  respectively for the predictive calculation by the approximation method to  $f_{m2}$  vibrational state, and vice versa. We note the overestimation of  $L_p$  level low frequency up to 80 Hz for both curves, and always increasing the level above 800 Hz in Figure 6, the effect is inverse in Figure 5.

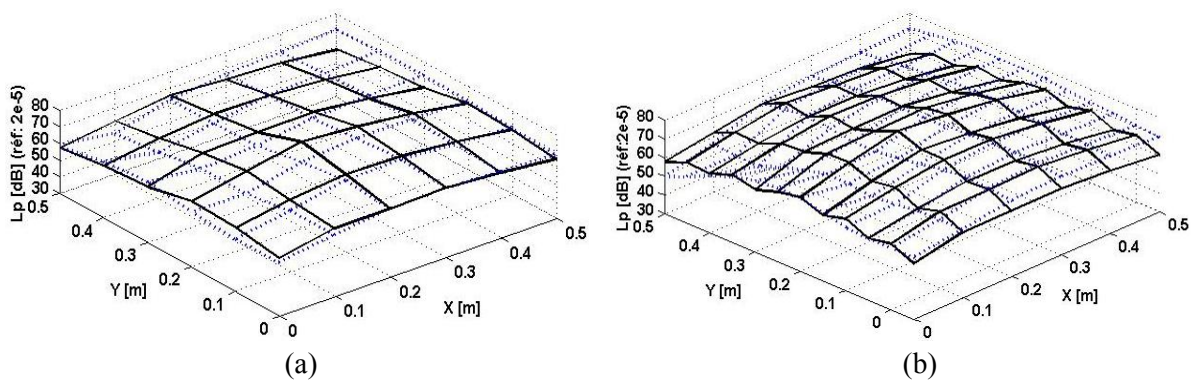


**Fig. 5.** Acoustic pressure level,  $mv=14$ ,  $np=72$   
 Calculation at  $M'(0.05, 0.15, 0.20)$  and  $f_{m2}=41.1$  Hz,  $G$  built at  $f_{m1}= 30.1$  Hz





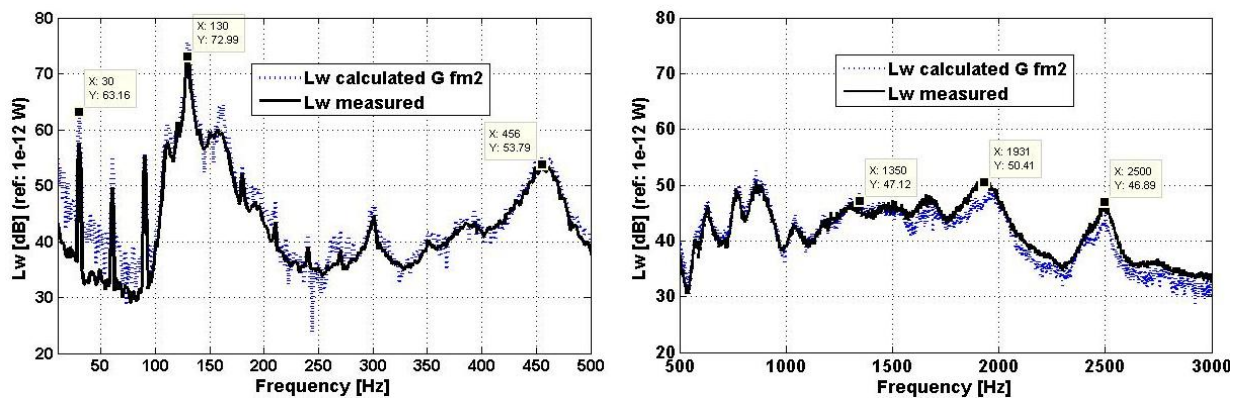
**Fig. 6.** Acoustic pressure level,  $mv=14$ ,  $np=72$   
 Calculation at  $M'(0.05, 0.15, 0.20)$  and  $f_{m1}=30.1$  Hz,  $G$  built at  $f_{m2}=41.1$  Hz



**Fig. 7.** Cartography of sound pressure level at  $f=130$  Hz,  
 $f_{m2}=41.1$  Hz,  $G$  built at  $f_{m1}=30.1$  Hz,  $mv=14$ , (a)  $np=npp=36$ , (b)  $np=npp=72$

The superposition of the sound pressure maps  $L_p$  calculated by the proposed approach at the same points as those measured in dashed blue, the measurement being continuously black to the vibrational state at  $f_{m2}$  using for  $G$  function built at  $f_{m1}$  is shown Figure 7. The plots are made at a frequency of 130 Hz (mode(1,1)) of the cover. Acoustic meshing sizes are worth  $np=36$  left and 72 right. We remark that at some points, the gap is larger; the error may come from the interpolation of the Green function  $G$  then disrupting the predictive calculation of the sound pressure.

**b. Calculation of the sound power level  $L_w$**



**Fig. 8.** Sound power level,  $mv=14$ ,  $np=72$ , Calculation at  $f_{m1}=30.1$  Hz,  $G$  built at  $f_{m2}=41.1$  Hz

### 3.1.2 Prediction in other points of the acoustic meshing

Sound power on curves 8 and 9 calculated by the proposed approach and using the vibroacoustic function  $G$  built for a different vibrational state has well predicted the acoustic radiation in this case for points outside the acoustic meshing. Regardless of this vibrational state higher or lower, the results are satisfactory and the calculation is at the same points of listening or other items provided results consistent  $L_p$  and  $L_w$  levels. Only those power curves were put to alleviate the report. The function  $G$  has fulfilled its role of transfer function.

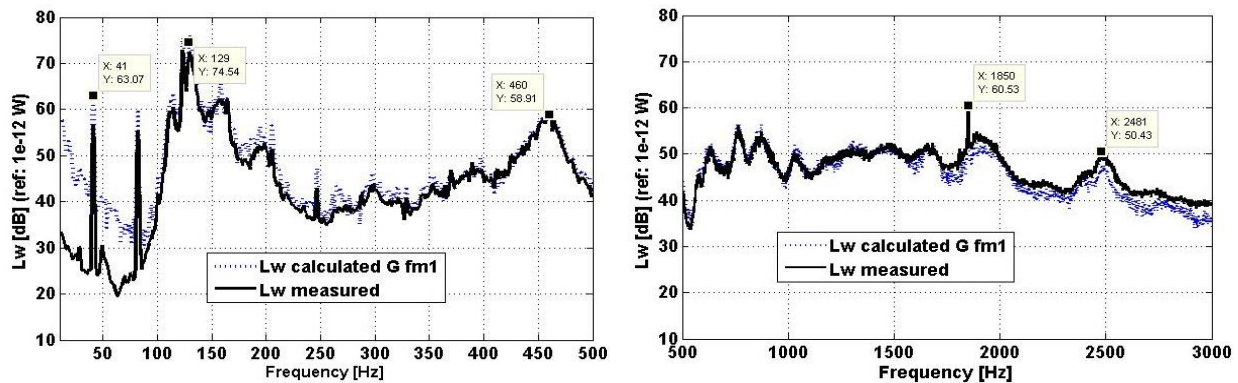


Fig. 9. Sound power level,  $mv=14$ ,  $np=72$ , Calculation at  $f_{m1}=41.1$  Hz,  $G$  built at  $f_{m2}=30.1$  Hz

## 4 Conclusions and perspectives

This method of approach differs from conventional FEM and BEM usual methods used in the calculation of acoustic radiation that are heavy, tedious and expensive to implement. With the acquisition of some normal vibrational velocities recorded in accessible locations of the geared transmission, and use of the Green's function  $G$  built for a vibrational state, the approach based on a monopole distribution allowed a good enough approximation of the acoustic radiation for other vibrational states related to the speed of rotation. The results are comparable, the disparities persist at low frequencies, significant peaks are found, nevertheless under estimates in intensity are observed on some frequency regions.

The objectives and points to be achieved are multiple and can be summarized in some suggestions such as improving the parameters used in the predictive calculating by the proposed approach, the performance of pressure convergence criteria for the same state or any other state vibration, the respective limits of the dimensions of vibration and acoustic mesh sizes that would best describe the acoustic radiation gear drives.

The monitoring of the evolution of the vibrational velocities over time and the use of the vibroacoustic transfer function  $G$  constructed digitally will monitor and diagnose gear drives.

## References

- [1] H. Opitz, Noise of gears, Phil. Trans. of Royal Society, 263:369-380, 1969.
- [2] D.R. Houser, Gear Noise Sources and their Prediction using Mathematical Models, Gear Design, SAE AE-15, Ch 16, Warrendale, 1990.

- 
- [3] A. Seybert, T. Wu and X. Wu, Acoustical Analysis of Gear Housing Vibration, Technical report, NASA Technical Memorandum 103691, 1991.
- [4] J. Sabot and J. Perret-Liaudet, Computation of the noise radiated by a simplified gearbox, Proceedings of the International Conference, pp: 63-68, University of Newcastle upon Tyne, UK, 1994.
- [5] J.D. Maynard, E.G Williams and Y. Lee, Nearfield acoustical holography: I. Theory of generalized holography and the development of NAH, Journal of Acoustic society of America 78(4), pp: 1395-1413, 1985.
- [6] J. Billingsley and R. Kinns, The acoustic telescope, Journal of Sound and Vibration 48(4), pp: 485-510, 1976.
- [7] W.A Veronesi and J.D. Maynard, Digital holographic reconstruction of sources with arbitrarily shaped surfaces, J. Acoust. Soc. Am., 85, pp: 588-598, 1989.
- [8] A. Schuhmacher and J. Hald, Sound source reconstruction using boundary element calculations, Brüel & Kjør A/S, Skodsborgvej 307, DK-2850 Naerum Denmark, 2001.
- [9] Y. Kim and P.A. Nelson, Spatial resolution for reconstruction of acoustic source strength by inverse method, Journal of Sound and vibration, Volume 265, Issue 4, 15 June, pp: 583-608, 2003.
- [10] C. Marquis, Construction de la fonction de transfert vibroacoustique pour la prédiction du rayonnement acoustique d'une structure sur site, thèse INSA de Lyon, 1997.
- [11] A. Derouiche, Modélisation Vibroacoustique d'un Système de Transmission par Engrenages Cylindriques à Denture Droite, thèse de Doctorat, USTHB, Algérie, 2013.
- [12] A. Derouiche, N. Hamzaoui, B. Bouzouane and A.H. Miloudi., Prediction of the Sound Radiation of a Gear Drives after Digital Construction of its Vibro-Acoustic Transfer Function, ICSV22, Florence, Italy, 12-16 July 2015 (accepted).