



HAL
open science

Dynamic Modeling for flexible wind turbine by the Bond Graph method

Yassine Lakhal, Fatima, Zahra Baghli, Larbi El Bakkali

► **To cite this version:**

Yassine Lakhal, Fatima, Zahra Baghli, Larbi El Bakkali. Dynamic Modeling for flexible wind turbine by the Bond Graph method. CFM 2015 - 22ème Congrès Français de Mécanique, Aug 2015, Lyon, France. ⟨hal-03446244⟩

HAL Id: hal-03446244

<https://hal.science/hal-03446244v1>

Submitted on 24 Nov 2021

HAL is a multi-disciplinary open access archive for the deposit and dissemination of scientific research documents, whether they are published or not. The documents may come from teaching and research institutions in France or abroad, or from public or private research centers.

L'archive ouverte pluridisciplinaire **HAL**, est destinée au dépôt et à la diffusion de documents scientifiques de niveau recherche, publiés ou non, émanant des établissements d'enseignement et de recherche français ou étrangers, des laboratoires publics ou privés.



HAL Authorization

Dynamic Modeling for flexible wind turbine by the Bond Graph method

Y. LAKHAL^a, F.Z. BAGHLI^a, L. EL BAKKALI^a

a. Modeling and simulation of mechanical systems team M2SM, UAE/E28FS, Faculty of science, Tetuan, morocco

Lakhal.yassine.doc@gmail.com

Abstract:

A wind turbine is a complex system, it contains many elements interconnected each other in a way that can capture and transmit the power flow captured by the rotor to the generator and convert it to electrical energy. Several elements of this system have a flexible nature, there have been lots of works on the modeling of flexible wind turbine, that they are based on different method, in this work we applied a graphical modeling approach called Bond graph, this method is based on the principle of energy conservation. The objective of this work is to develop a non-linear model that describes the behavior of wind turbine system taking account of the flexibility of the blades, drivetrain and tower. Finally we approve we compare the result obtained with bond graph approach with method classical method of control in order to justify the efficiency of this approach.

Keywords: bond graph, wind turbine, modeling dynamic, flexibility, energy, non-linear

1 Introduction

The necessity to develop alternative energy resources motivates researchers to develop more profitable models of wind turbine, more stable and with minimal cost of production, the improvement of the performances of the systems need the total knowledge of the behavior of the system; this remains a difficult task due to the complexity of the system. Wind turbines are mechanical systems with complex structure, several elements have large flexibility as blades, towers and the drivetrain, this flexibility has a great influence on the behavior of the system, they can set the unwanted vibration and excites some resonance frequency, it can also create fluctuations in the level of energy, then his negligence when modeling is not beneficial. We can ever talking of control or optimization of a wind turbine without mentioning the modeling; it's a critical task, the most of researches in this field aim to found methods more simple and effective model that describes the system's behavior so as precise.

The majority of these works are based on classical methods, In earlier literature, we find [10] and [5] which is based on the LAGRANG and KAN methods, other works are based on the Finite elements method that we can find [7],

The works that chosen bond graph as a modeling method of flexible wind turbine are scarce; the majority of theme neglects the flexibility of several important elements of wind turbine.

In this work we have chosen to apply the bond graph method to modeling a flexible wind turbine, it is a graphical way of modeling physical systems. All these physical systems have in common the conservation laws for mass and energy, in 1961, deals with the conservation of energy. This gives a

unified approach to modeling physical systems. Further follows a short introduction to this modeling tool, more information can be found in [xxx].

2 Bond graph language elements

The bond graphs elements are classified as passive elements, active elements and junction elements. These elements constitute the bond graph language.

The passive elements:

The elements R, C and I are called passive elements because they transfer the power given to them as a dissipated energy in heat form (element R) or stocked (element I and C). The power is given to elements, which impose to repair the direction of the half-arrow of the bond towards these elements. The connection of the bond and the elements of the bond graph, show the articulation of the energy exchanges between the different parts of a system, and with its environment. Each element is associated to a phenomenon.

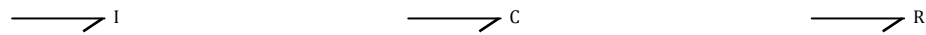

Figure 1: Bond graph passive components

The active elements:

The effort source respectively of flow (Se resp. Sf) is associated to an effort (resp. a flow) imposed to the system (depend to a couple motor -resp. a rotation velocity – imposed by an actuator on a tree for example).



Figure 2: Bond graph active components

Junctions:

Components are connected together using two types of junctions: a 0 or common effort junction and a 1 or common flow junction.

The 0 junction has the following properties: all bonds impinging upon it have the same effort variable and all flows on attached bonds sum to zero. Similarly the 1 junction has the properties: all bonds impinging upon it have the same flow variable and all effort on attached bonds sum to zero.

To transfer between physical domains the ability to multiply must be included and bond graphs provide two means of accomplishing this: the Transformer TF and the Gyration Gy (TF or Gy are energy conserving).

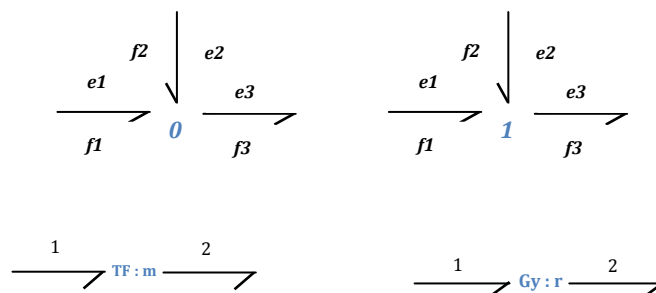

Figure 3: Illustration of junction

The causality assignment rules

Bond graphs have a notion of causality, indicating which side of a bond determines the instantaneous effort and which determines the instantaneous flow. In formulating the dynamic equations that describe the system, causality defines, for each modeling element, which variable is dependent and which is independent.

Table 2 shows the permitted causality permutations for components, junctions and transformers respectively.

Table 1 : Causality stroke and Assignments for bond graph

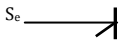
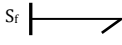
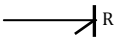
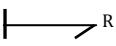
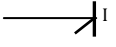
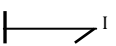
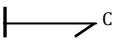
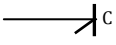
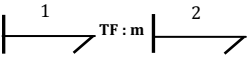
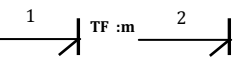
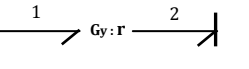
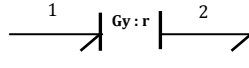
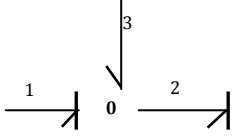
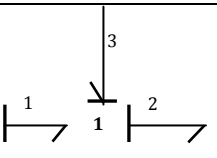
Causal form	Causal relation	Type
 	$e = S_e$ $f = S_f$	Fixed Causality
 	$f = \frac{e}{R}$ $e = R * f$	Resistor Conductivity
 	$f = \frac{1}{I} \int e dt$ $e = I \frac{df}{dt}$	Integral Derived
 	$e = \frac{1}{C} \int f dt$ $f = I \frac{de}{dt}$	Integral Derived
	$e_1 = m * e_2 ; f_2 = m * f_1$	Symmetric
	$e_2 = \frac{e_1}{m} ; f_1 = \frac{f_2}{m}$	Symmetric
	$e_1 = r * f_2 ; e_2 = r * f_1$	Antsymmetric
	$f_2 = \frac{e_1}{r} ; f_1 = \frac{e_2}{r}$	Antsymmetric
	$e_2 = e_3 = e_1$ $f_1 = f_2 + f_3$	One effort is imposed on the junction 0
	$f_2 = f_3 = f_1$ $e_1 = e_2 + e_3$	One flow is imposed on the junction 1

3 Flexible Wind turbine Modeling

3.1 Proposed model description

In this section a flexible model is proposed including the necessary dynamics, this model describes the flap wise of blades in plan, tower bending and the dynamic of the drivetrain, this last one is considered as three mass drivetrain, the figure 2 shows the structure of the proposed model .

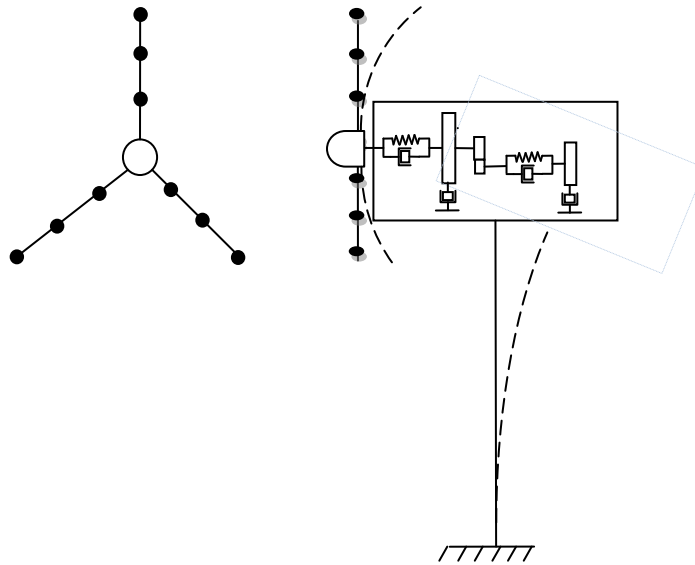

Figure 4: proposed model structure

To simplify the modeling of the system, we divided the system model on several sub-models, the representation of the wind turbine is developed by assembling bond graph represent of the different elements as shown in the word bond graph figure 2

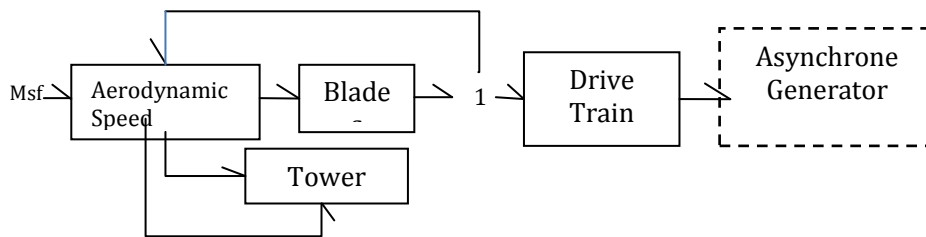

Figure 5: Word bond graph of flexible Wind turbine

4 Blades model

The proposed model is based on Euler Bernoulli beam model and blade elements momentum BEM, the global model is built from coupling between aerodynamic model and structural model, the structure of model is shown in the follows figure.

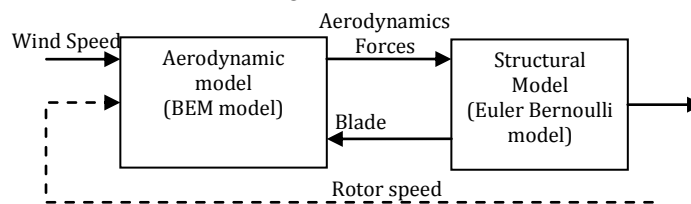

Figure 6 : blade model

In this model, we include just the flapwise bending, we neglect the edgewise and torsional vibration of blade.



Figure 7: Blade flapwise deflection

4.1 Structural model

Different approach can be user to reformulate the model of flexible beam, in this work we are choose to use the Bernoulli-Euler method, it's designed for the beams with uniform sections and small deformation, against a wind turbine blade has a flexible structure with large deformation, and has a different sections dimensions.

For applying this method of blade with large deformation we propose to divide the structure into three elements, the total deformation of blade is the sum of deformation of sections.

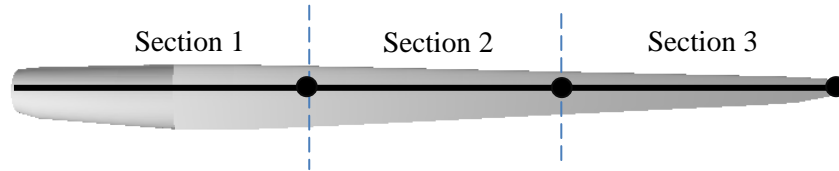

Figure 8: blade structure and sections

A generic bond graph approximation of one dimensional focusing on fundamental aspects, let us consider the classical example of a beam assuming the Bernoulli hypothesis that rotary inertia and shear deformation can be neglected (Bernoulli-Euler beam) .Let us also assume that only transversal forces act on the beam.

The bond graph presented following describe the model of one flexible blade, an integral causality is imposed.

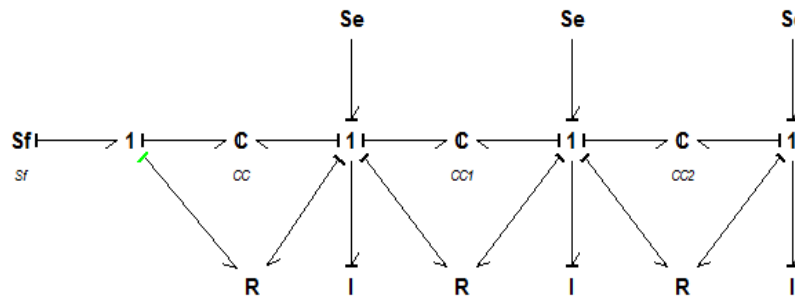

Figure 9: structural model of flexible blade

The boundary condition of the blade model is represented by the S_f and S_e sources. The connection between the blade and the hub is assumed to be rigid, this means $S_f = 0$. S_{e1} , S_{e2} , and S_{e3} are the aerodynamics forces applied on blade, C_i represents the stiffness of each elements of blade, R_i and I_i represent respectively the damping and the masses of elements.

Equation of motion :

to get the dynamic model of the blade, we have followed the bond graph process, firstly we determine the equation assisted to each junction and each elements.

Table 2 : Equation associated to junctions

Junction "1"	Elements Junction
$\text{"1"} \begin{cases} \ddot{f}_1 = \ddot{f}_2 = \ddot{f}_3 \\ e_1 - e_2 - e_3 = 0 \end{cases}$	$S_f : f_1 = S_f$ $S_{e1} : e_6 = S_{e1}$ $S_{e2} : e_{15} = S_{e2}$ $S_{e3} : e_{19} = S_{e3}$
$\text{"1"} \begin{cases} f_4 = f_5 = f_6 = f_7 = f_8 = f_9 \\ e_6 - e_4 - e_5 - e_7 - e_8 - e_9 = 0 \end{cases}$	$R_1 : \begin{cases} e_3 = R_1 f_3 \\ e_5 = R_1 f_5 \end{cases} \quad R_2 : \begin{cases} e_8 = R_2 f_8 \\ e_{11} = R_2 f_{11} \end{cases} \quad R_3 : \begin{cases} e_{13} = R_3 f_{13} \\ e_7 = R_3 f_{17} \end{cases}$

4.2 Aerodynamic model

The aerodynamic model is used to calculate the aerodynamic loads applied in the structure of the blades from wind speed and rotational speed of the rotor and the pitch angle of the blades, they are calculated by using the they are calculated by using the method BEM method [4].

The blade structure is divided in sections. For each section BEM theory is applied, in order to provide aerodynamic force to the blade structure. Eq. (1) expresses the aerodynamic force F_i applied to the i^{th} section.

$$F_i = \left(\frac{1}{2} \rho V_w \frac{(1-a_i)}{\sin^2 \Phi_i} (C_{li} \sin \Phi_i - C_{di} \cos \Phi_i) C_{l_i}\right) V_w \tag{11}$$

where V_w represents the wind velocity, ρ the air density, Φ_i the wind inflow angle expression (2), C_{li} and C_{di} are the lift and drag dimensionless coefficients function on the angle of attack α_i , defined as the angle between the incoming flow stream and the chord line of the airfoil in the i^{th} section.

$$\Phi_i = \tan^{-1} \left(\frac{V_w (1-a_i)}{\omega_r r_i (1+a_i')} \right) \tag{12}$$

a_i Represents the axial tangential induction factor and is calculated from expressions (3) and (4).

$$a_i = \left(1 + \frac{4 \sin^2 \Phi_i}{\sigma_i' (C_{li} \cos \Phi_i + C_{di} \sin \Phi_i)} \right)^{-1} \tag{13}$$

$$a_i' = \left(-1 + \frac{4 \sin^2 \Phi_i}{\sigma_i' (C_{li} \cos \Phi_i - C_{di} \sin \Phi_i)} \right)^{-1} \tag{14}$$

The parameters of equations are presented graphically in the fig.5

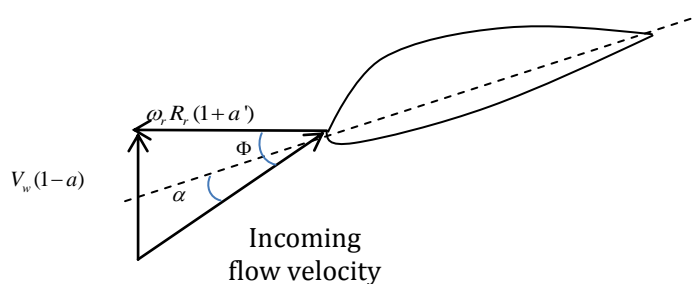

Figure 10 : airfoil section of blade

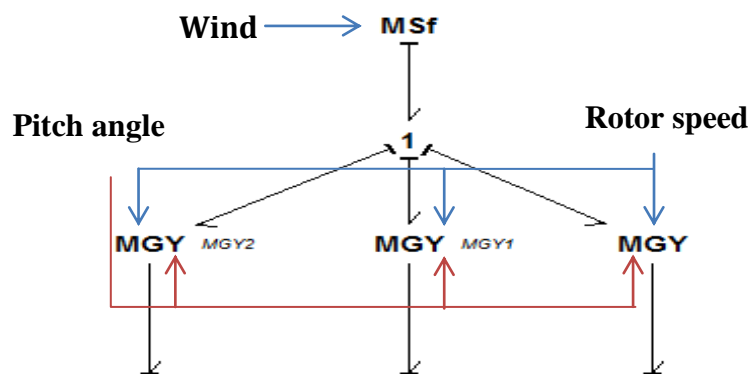

Figure 11 : bond graph of aerodynamic model

A MGY (modulated gyrator) element is used to implement Eqs. (2-4), since wind (MSf source) is transformed into a Se source (aerodynamic force), as shown in figure 7.

5 Drive train model

the proposed model of drivetrain include three masses, the first one is the low speed shaft inertia noted J_{lss} , the second is the masses of gear box elements noted J_{G1} and J_{G2} , and J_{hss} is the inertia of the height speed shaft, in this model we include also the flexibility of each shaft, its expressed by a coupled spring damper noted respectively (B_r, K_{lss}) and (B_{hs}, K_{hss}) , B_r, R_g and B_g present respectively the friction coefficients of the rotor, gear box and the generator.

The model bond graph model of proposed model is presented by the following figure

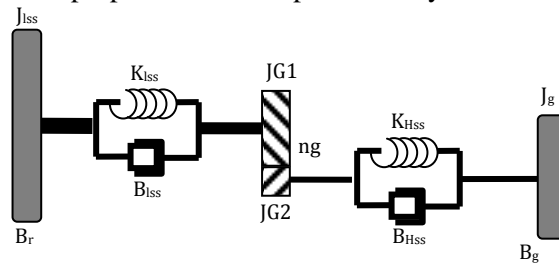

Figure 12: model of drivetrain

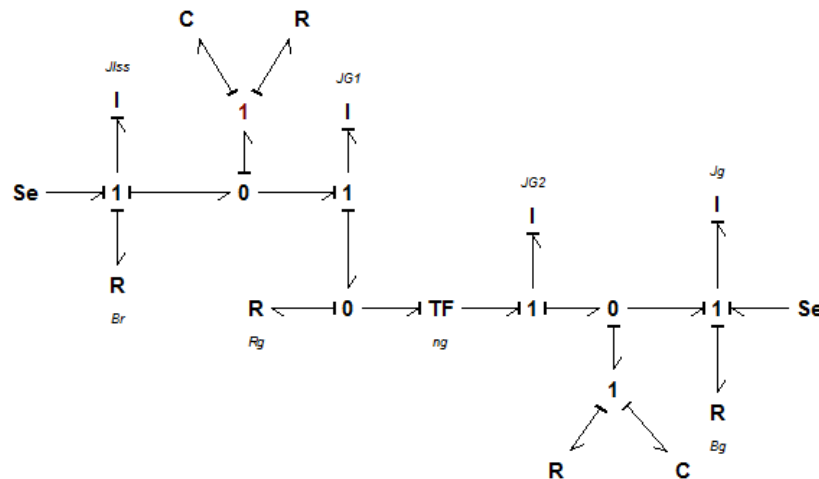

Figure 13: bond graph model of drivetrain

Equation of motion

Table 3: Equation associated to junctions

Junction "1"	Junction "0"	Transformer	Elements Junction
$"1" \begin{cases} f_1 = f_2 = f_3 = f_4 \\ e_1 - e_2 - e_3 - e_4 = 0 \end{cases}$	$"0" \begin{cases} e_4 = e_5 = e_6 \\ f_4 - f_5 - f_6 = 0 \end{cases}$	$"TF : n_g" \begin{cases} e_{13} = \frac{1}{n_g} e_{12} \\ f_{12} = \frac{1}{n_g} f_{13} \end{cases}$	$"S_e" : \begin{cases} T_a : e_1 = S_{e1} \\ T_{em} : e_{21} = S_{e2} \end{cases}$

"1" $\begin{cases} f_5 = f_7 = f_8 \\ e_5 - e_7 - e_8 = 0 \end{cases}$	"0" $\begin{cases} e_{10} = e_{12} = e_{12} \\ f_{10} - f_{11} - f_{12} = 0 \end{cases}$	"I" : $\begin{cases} J_{ss} : f_2 = \frac{1}{J_{SS}} P_2 \\ J_{G1} : f_9 = \frac{1}{J_{G1}} P_9 \\ J_{G2} = f_{14} = \frac{1}{J_{G2}} P_{14} \\ J_g : f_{22} = \frac{1}{J_g} P_{22} \end{cases}$
"1" $\begin{cases} f_{13} = f_{14} = f_{15} \\ e_{13} - e_{14} - e_{15} = 0 \end{cases}$	"0" $\begin{cases} e_{15} = e_{16} = e_{17} \\ f_{15} - f_{16} - f_{17} = 0 \end{cases}$	"I" : $\begin{cases} J_{ss} : f_2 = \frac{1}{J_{SS}} P_2 \\ J_{G1} : f_9 = \frac{1}{J_{G1}} P_9 \\ J_{G2} = f_{14} = \frac{1}{J_{G2}} P_{14} \\ J_g : f_{22} = \frac{1}{J_g} P_{22} \end{cases}$
"1" $\begin{cases} f_{16} = f_{18} = f_{19} \\ e_{16} - e_{18} - e_{19} = 0 \end{cases}$		"R" : $\begin{cases} Br : e_3 = B_r f_3 \\ B_g : e_{20} B_g f_{20} \\ B_{ls} : e_8 = R_1 f_8 \\ B_{hs} : e_{18} = R_2 f_{18} \\ R_g : e_{11} = R_g f_{11} \end{cases}$
"1" $\begin{cases} f_{17} = f_{20} = f_{21} = f_{22} \\ e_{17} - e_{20} - e_{21} - e_{22} = 0 \end{cases}$		"C" : $\begin{cases} k_{ls} : e_7 = \frac{1}{k_{ls}} q_7 \\ k_{hs} : e_{19} = \frac{1}{k_{hs}} q_{19} \end{cases}$
"1" $\begin{cases} f_6 = f_9 = f_{10} \\ e_6 - e_9 - e_{10} = 0 \end{cases}$		

Expressions of variables stats equations:

We proceed in the same process, and we find the states variables that are presented by the following equation.

$$\dot{P}_2 = T_a - \left[+ \frac{B_r + B_{ls}}{J_{ls}} \right] P_2 - \frac{1}{C_1} q_7 + \frac{k_{ls}}{J_{G1}} P_9 \quad (15)$$

$$\dot{P}_9 = \frac{1}{C_1} q_7 + \frac{B_{ls}}{J_{ls}} P_2 - \frac{B_{ls}}{J_{G1}} P_9 - \frac{B_g}{J_{G1}} P_9 + \frac{B_g}{n_g J_{G2}} P_{14} \quad (16)$$

$$\dot{P}_{22} = \left(\frac{R_2}{J_{G2}} P_{14} - \frac{R_2}{J_g} P_{22} + \frac{1}{C_2} q_{19} \right) + T_{em} - \frac{B_g}{J_g} P_{22} \quad (17)$$

$$\dot{q}_{14} = \frac{R_g}{n_g J_{G1}} P_9 - \frac{R_g}{n_g J_{G2}} P_{14} - \frac{1}{C_2} q_{19} - \frac{R_2}{J_g} P_{22} \quad (18)$$

$$\dot{q}_7 = \frac{1}{J_{ls}} P_{14} + \frac{R_2}{J_{G1}} P_9 \quad (19)$$

$$\dot{q}_{12} = \frac{1}{J_{G2}} P_{14} - \frac{1}{J_g} P_{22} \quad (20)$$

Hence the state equation is:

$$\begin{bmatrix} \dot{p}_2 \\ \dot{p}_9 \\ \dot{p}_{22} \\ \dot{p}_{14} \\ \dot{q}_7 \\ \dot{q}_{19} \end{bmatrix} = \begin{bmatrix} -\frac{B_r - R_1}{J_{ls}} & \frac{R_1}{JG_1} & 0 & 0 & -\frac{1}{c_1} & 0 \\ \frac{R_1}{J_{ls}} & -\frac{(R_1 + R_9)}{JG_1} & 0 & \frac{R_g}{n_g J_{G2}} & \frac{1}{c_1} & 0 \\ 0 & 0 & -\frac{R_2 - B_g}{J_g} & \frac{R_2}{JG_2} & 0 & \frac{1}{c_2} \\ 0 & \frac{R_g}{n_g J_{G1}} & \frac{R_2}{J_g} & -\frac{R_g}{n_g^2 J_{G2}} - \frac{R_2}{JG_2} & 0 & -\frac{1}{c_2} \\ \frac{1}{J_{ls}} & \frac{1}{J_{G1}} & 0 & 0 & 0 & 0 \\ 0 & 0 & -\frac{1}{J_g} & \frac{1}{J_{G2}} & 0 & 0 \end{bmatrix} \begin{bmatrix} P_2 \\ P_9 \\ P_{22} \\ P_{14} \\ q_7 \\ q_{19} \end{bmatrix} + \begin{bmatrix} 1 & 0 \\ 0 & 1 \\ 0 & 0 \\ 0 & 0 \\ 0 & 0 \\ 0 & 0 \end{bmatrix} \begin{bmatrix} T_a \\ T_{em} \end{bmatrix} \tag{21}$$

6 Tower motion model

It is assumed that the tower movement does not influence the mechanical system; it only affects its input

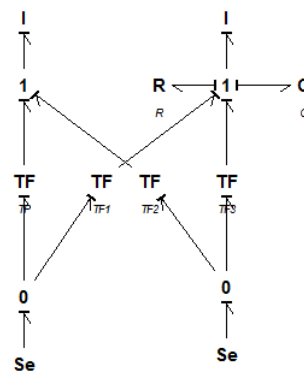

Figure 14: bond graph model of tower

7 assemblage model

The individual models presented in previous sections are assembled as shown in figure 15.

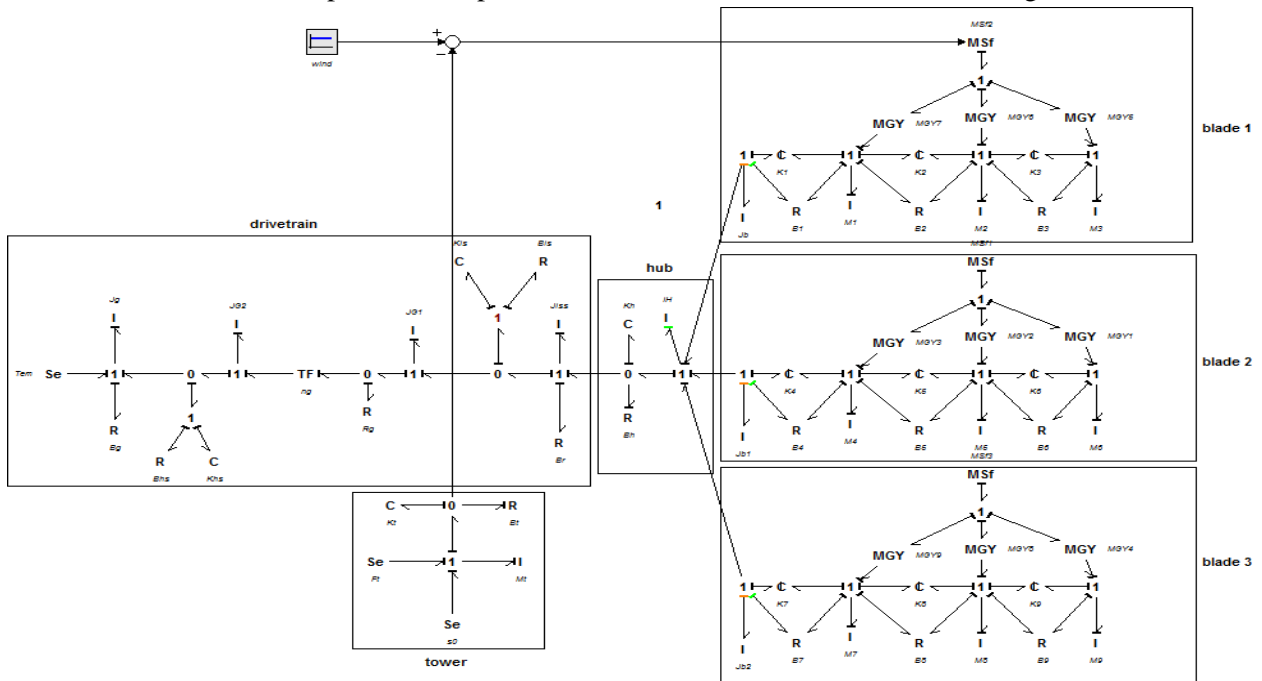

Figure 15: assemblage bond graphs of wind turbine

8 Conclusion

In this work, a model of a flexible wind turbine is built by using the bond graph method; we introduced in this model the flexibility of blades, shafts, and the tower we finally got a complete model that describes the behavior of wholes the essential elements of the system and less difficult than other methods, in the future work we will analyze the behavior of de system and we will compare it with a classical method to show the efficiency of this method.

References

- [1] Tore Bakka and Hamid Reza, Bond graph modeling and simulation of wind turbine systems, *Journal of Mechanical Science and Technology* 27 (6) (2013) 1843~1852
- [2]Fatima Zahra Baghli, Larbi El bakkali, Modeling and Analysis of the Dynamic Performance of a Robot Manipulator driving by an Electrical Actuator Using Bond Graph Methodology, *International Journal of Mechanical & Mechatronics Engineering IJMME-IJENS* Vol:14 No:04
- [3]Wolfgang Borutzky, *Bond Graph Methodology*, Springer-Verlag London Limited 2010
- [4]Y. Lakhel, Baghli F, L. El Bakkali, Dynamic Modeling and Simulation of a Flexible Wind Turbine for a Multi-objectives Control. *International Journal of Mechatronics, Electrical and Computer Technology*; Vol. 4(10), Jan, 2014, Special Number, pp. 1063-1083, ISSN; 2305-0543
- [5] Alan D. Wright, *Modern control design for flexible wind turbine*, Technical Report National renewable, energy laboratory–colorado.USA.
- [6] Y. Lakhel, Baghli F, L. El Bakkali, Fuzzy Logic control strategy for maximum power point tracking for horizontal axis wind turbine, *Volume 19C*, 2015, Pages 599-606
- [7] R. Oulad Ben Zarouala, C. Vivas, J. A. Acosta, and L. El Bakkali, On Singular Perturbations of Flexible and Variable-Speed Wind Turbines” *International Journal of Aerospace Engineering* Volume 2012
- [8] Anders Ahlstrom, *Aeroelastic Simulation of Wind Turbine Dynamics*, April 2005, Doctoral Thesis from Royal Institute of Technology Department of Mechanics SE-100 44 Stockholm, Sweden