



**HAL**  
open science

## **PLACIS: a general project-based learning framework illustrated with a concrete example**

Alexis François, Antoine Lanthony, Moncef Hammadi, Stanislao Patalano,  
Ottorino Veneri

### ► **To cite this version:**

Alexis François, Antoine Lanthony, Moncef Hammadi, Stanislao Patalano, Ottorino Veneri. PLACIS: a general project-based learning framework illustrated with a concrete example. CFM 2015 - 22ème Congrès Français de Mécanique, Aug 2015, Lyon, France. hal-03444534

**HAL Id: hal-03444534**

**<https://hal.science/hal-03444534>**

Submitted on 23 Nov 2021

**HAL** is a multi-disciplinary open access archive for the deposit and dissemination of scientific research documents, whether they are published or not. The documents may come from teaching and research institutions in France or abroad, or from public or private research centers.

L'archive ouverte pluridisciplinaire **HAL**, est destinée au dépôt et à la diffusion de documents scientifiques de niveau recherche, publiés ou non, émanant des établissements d'enseignement et de recherche français ou étrangers, des laboratoires publics ou privés.

# PLACIS: a general project-based learning framework illustrated with a concrete example

A. FRANCOIS<sup>a</sup>, A. LANTHONY<sup>b</sup>, M. HAMMADI<sup>c</sup>  
S. PATALANO<sup>d</sup>, O. VENERI<sup>e</sup>

a. ISMEP-Supméca ; alexis.francois@supmeca.fr

b. ISMEP-Supméca ; antoine.lanthony@supmeca.fr

c. LISMMA – ISMEP-Supméca ; moncef.hammadi@supmeca.fr

d. Università di Napoli Federico II ; patalano@unina.it

e. Istituto Motori – Consiglio Nazionale delle Ricerche ; o.veneri@im.cnr.it

## Résumé :

*PLACIS (PLAteforme Collaborative d'Ingénierie Systèmes) est un projet financé par l'Agence Nationale de la Recherche dans le cadre des Investissements d'Avenir. PLACIS a débuté en septembre 2012 et est piloté par l'Institut Polytechnique Grand Paris (IPGP, constitué de : ISMEP – Supméca, ENSEA et EISTI). Ce projet de grande ampleur promeut un apprentissage et un enseignement actifs à travers des projets collaboratifs, industriels et internationaux, réalisés à distance par des étudiants ingénieurs. Depuis son commencement, PLACIS a gagné en maturité non seulement avec de nouveaux étudiants et projets, mais aussi via le développement de nouveaux outils comme une future plateforme d'apprentissage : un environnement d'apprentissage web 3.0 distribué, adaptable, collaboratif, sémantique et social, et la mise en place d'une boîte à outils pour les enseignants afin d'évaluer compétences et connaissances en apprentissage par projet, dans le cadre d'un projet Erasmus+ mené en parallèle (EPICES : European Platform for Innovation and Collaboration between Engineer Students). L'objectif est de développer ou créer l'implication des enseignants et des étudiants dans de nouvelles pratiques d'enseignement (apprentissage par projet, apprentissage par problème, petits cours privés en ligne) nécessaires à la mise en place d'une alternative à la configuration traditionnelle cours / travaux dirigés / travaux pratiques. Tous ces aspects nous permettent de voir les premiers résultats de ce qui est le but principal du projet : entraîner les étudiants non seulement à devenir des ingénieurs classiques, mais aussi à être capable de comprendre des problématiques multidisciplinaires et industrielles, à travailler en équipes, avec des personnes de différentes cultures et, plus généralement, à être acteurs de leurs cursus et à se mouvoir aisément dans le monde industriel d'aujourd'hui et de demain. Nous pouvons facilement nous appuyer sur l'exemple du projet industriel mis en place depuis le démarrage de PLACIS en septembre 2012 et toujours en cours entre l'Institut des Moteurs – CNR (IM-CNR), l'Université Federico II de Naples (UNINA) et l'Institut Polytechnique Grand Paris (IPGP).*

## Abstract:

*PLACIS (Collaborative Platform for Systems Engineering) is a project funded by the French National Agency for Research under "Investments for the future" program. PLACIS started in September 2012*

and is run by Institut Polytechnique Grand Paris (IPGP, gathering ISMEP – Supméca, ENSEA and EISTI). This large-scale project promotes active learning and teaching through industrial, international and at-a-distance collaborative projects, carried out by engineer students. Since its beginning, PLACIS has gained in maturity not only with new students' projects and new partners, but also with the development of new tools like a future learning platform: an adaptive, collaborative, semantic and social web 3.0 distributed learning environment, and an implementation of a toolbox for teachers to assess skills and knowledge in project-based learning with an Erasmus+ project in parallel (EPICES: European Platform for Innovation and Collaboration between Engineer Students). The objective is to develop or create the involvement of teachers and students into new teaching practices (project-based learning, problem-based learning, small private online courses) necessary for the implementation of an alternative to the traditional configuration courses / supervised work / practical classes. All these aspects enable us to see the first achievements of what is the main goal of the project: to train students not only to become classic engineers, but also to be able to understand multidisciplinary and industrial issues, to work in teams, with people from different cultures and, more generally, to be actors of their curricula and to move easily in today's and tomorrow's industrial world. We can easily rely on the example of an industrial project especially set up from the beginning of PLACIS in September 2012 and which is still in progress between Istituto Motori – CNR (IM-CNR), Università di Napoli Federico II (UNINA) and Institut Polytechnique Grand Paris (IPGP).

**Key words: collaborative ; international ; industrial ; project-based learning ; problem-based learning ; systems engineering ; apprentissage par projet ; apprentissage par problème ; collaboratif ; industriel ; ingénierie systèmes ; Modelica**

## 1 Introduction

In France and in most of the industrialized countries, companies face a lack of systems engineers. This profile is defined in the CarTesa report produced for the Paris Region Systems & ICT Cluster Systematic as follows: “an experienced systems engineer is someone who, in addition to a strong background in engineering, has a capacity for abstraction, communication with teams like the end customer, leadership, innovation and an understanding of the company's business. He is someone who, having an overall vision of the project, “manages the system in all its complexity” [1]. The recruitment flow of well-prepared young graduates to carry out these functions is promising; to meet this need is one of the elements of the re-industrialization of Western Europe.

There are also discussions and actions in order to seek possible alternatives to traditional configuration courses / supervised work / practical classes notably through project-based learning (PtBL) and / or problem-based learning (PmBL)

Higher education seeks to address these issues and prepare engineers in general and systems engineers in particular, assuming that the skills cannot be acquired only by learning knowledge or through the implementation of technical tools. A realistic scenario, monitored and supervised, is the best way to prepare future engineers for the real industrial / research world.

Based on this context and with a consolidated experience in PmBL and systems engineering, Institut Polytechnique Grand Paris (IPGP) answered a call for innovative learning schemes (IDEFI -

“Excellence initiatives for innovative training”) from the French National Agency for Research<sup>1</sup> and was granted a special funding to develop PLACIS in September 2012.

The IDEFI PLACIS, which was presented at the WEEF2014 [2], has two main objectives. Firstly, it is an approach to educational research, preparing students to systems engineering and to the professional world they will meet when they are in the industry. Secondly, it allows developing and testing the tools and collaborative and / or digital methods to achieve in a PtBL or PmBL framework. The training process driven by our platform and our collaborative tools allow, in particular, student groups in several remote locations to participate in industrial and / or international projects. It, therefore, implements teaching methods based on participant observation, learning by doing, experience share and experience in an industrial or pseudo-industrial environment. PLACIS is destined for the creation, development and testing of an international platform “for collaborative engineering” expandable later to other areas of education (science, medicine, economics ...). The idea of this new training scheme is to prepare future graduates to work as systems engineers in a changing globalized world, in which working in international teams, distributed over many locations, composed of members having different cultures and working habits becomes the norm.

Academic institutions like Università di Napoli Federico II (UNINA), Politecnico di Torino, Hochschule Esslingen or ENSAM Meknès are PLACIS partners, with an involvement of both students and teachers. Many companies are also PLACIS partners in various ways: engineering system software providers like Dassault Systemes or providers of industrial research project subjects like Bosch, Festo, Hutchinson or Istituto Motori – CNR (IM-CNR). Most of these projects are confidential, as it is most of the time the case in the industrial world. But here, we can easily rely on the example of one part of an industrial project especially set up from the start of PLACIS in September 2012 and which is still in progress between Istituto Motori – CNR (IM-CNR), Università di Napoli Federico II (UNINA) and Institut Polytechnique Grand Paris (IPGP, mainly through ISMEP-Supméca): the development of a Modelica library for the preliminary design of electric powertrains.

We will explain PLACIS in detail, then focus on the IM-CNR – UNINA – IPGP project and finally conclude with a broadening of the topic to the new Erasmus+ project launched in parallel to PLACIS.

## **2 PLACIS general framework**

### **2.1 Description of projects for Master students**

PLACIS is an innovative training scheme for engineer students. PLACIS places students in realistic situations and makes them feel the reality of a project.

PLACIS projects for Master students are collaborative, multidisciplinary, industrial and, most of the time, international with a foreign academic partner and / or a foreign company. There are bilateral as well as trilateral levels of interaction between stakeholders.

PLACIS projects for Master students are in a PtBL framework, according to Prince and Felder definition in their article “Inductive Teaching and Learning Methods: Definitions, Comparisons, and Research Bases” [3]. It means that they are broader and present more elements than classical PmBL or

---

<sup>1</sup> The PLACIS project is managed by the French National Agency for Research under “Investments for the future” program with the reference ANR-11-IDFI-0029.

capstone projects, for example as defined by Ward in 2013: PmBL being for him “pedagogy in which students learn about subjects by solving complex, multidisciplinary and realistic design problems” [4]. PLACIS projects for Master students go beyond that, especially with their multi-location and multi-actor dimension as presented in figure 1.

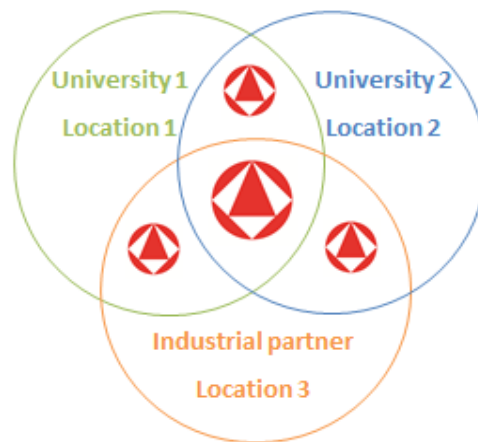

**Figure 1:** Interactions between stakeholders located in different places

These projects work according to a 6-point organizational scheme (table 1) and last a semester. A semester is a duration scale of PLACIS projects for Master students, but the latter can last several semesters, in order to be as close to the industrial world as possible.

- |  |
|--|
| <p>a) A company proposes a project (a new one or the continuation of an ongoing one) requiring expertise from different engineering fields.</p> <p>b) Industrial and academic partners discuss in order to better define and validate the subject.</p> <p>c) Groups of students are formed in both universities in order to create a team.</p> <p>d) A kick-off meeting is organized with all the people involved in the project, in the industrial company.</p> <p>e) Then, students carry out their project while staying in their home university and using the tools of collaborative engineering. They are tutored by teachers and by a person from the industrial company providing the subject.</p> <p>f) The performance is assessed by the industrial partner and the teachers.</p> |
|--|

**Table 1:** Organizational scheme of a PLACIS project for Master students (for one semester)

These projects enable Master students to be prepared for the conditions now prevailing in the industrial world, thanks to the multicultural and multidisciplinary experience they gain.

Students from IPGP are involved in that way:

- Master 1, from April to June, 100 hours / student,
- Master 2, from September to February, 300 hours / student or from December to February, 150 hours / student.

For Master 2 students choosing to carry out a 300-hour project, an individualized learning path is defined and agreed between the student, the referent teacher from his final year specialization and the teacher referent for the project he has chosen: depending on the project, some courses become optional for the student in exchange for his involvement in PtBL.

4 projects were active in 2012/2013, 10 in 2013/2014 and 12 in 2014/2015.

## 2.2 Tools used in PLACIS projects

In the framework of PLACIS, a new 3.0 platform has been developed. Being adaptive, collaborative, semantic and social, this platform will allow two main results, which will become tools for users:

- Each project will have a real community place online,
- Each student will be able to follow his individual learning path through a real learning management system.

It means that the working environment of the students will become closer to the working environment in a company, but also that the studying environment will change, for example with the introduction of small private online courses (SPOC) [5], added in the learning path of the students who need it for the project they are involved in or to improve their level.

Gradually, it will become possible for the students to also use new devices: smartphones and tabs will have software interface that will make it possible to work not only on the platform, but also on engineering software and tools, via an interface and virtualization work.

In order to carry out their projects and learn how to work in the project mode, students use new tools or use previous tools differently. The use of some of these tools is facilitated by a partnership with Dassault Systèmes. Table 2 presents a summary of these tools.

Catia V6	Abaqus
Dymola	Artisan Studio
SysML	WebEx
ANSYS tools	Skype
Simulia	SharePoint
Matlab	and the new 3.0 platform

**Table 2:** Engineering and collaborative tools used by students in PLACIS projects

## 2.3 Assessment methods

There are two kinds of assessment:

- Assessment of the work done in each project, i.e. assessment of students,
- Assessment of PLACIS itself.

For the moment the assessment methods mainly include:

- Assessment by the teaching staff and by the supervisor of the industrial partner of the commitment, motivation, autonomy, organization skills and project management skills of the team members,
- Assessment of the deliverables (written technical report, final presentation, mock-ups, posters) by the teaching staff and by the supervisor of the industrial partner.
- A special PLACIS day is organized for this purpose, in order to gather all PLACIS actors and make it possible to share the experience.

Although the direct assessment of the deliverables seems straightforward and looks familiar for the assessors, there are discussions how to assess the quality of the models designed by the students and how to do this in a consistent manner across projects.

Moreover, for some projects, the quality of final results produced by the team may be poor while, nevertheless, the learning outcomes are reached.

In order to realize an assessment of PLACIS itself, surveys of the stakeholders are carried out at the end of each phase of a project. Among other results from these surveys, we noted that both students and teachers want more clarification about assessment methods of the students. Besides, when something new is introduced, they are not reluctant, but ask for very clear rules, for example about poster sessions.

Furthermore, it was qualitatively observed that teams composed of students with different backgrounds are very efficient, if not more than others, but they are not numerous. Especially, when it is time for the students to come together and form a team, we observed that students naturally form very coherent teams (for example, only with students in academic mobility).

Examples of qualitative and quantitative feedbacks we got from PLACIS assessments, especially from surveys, are:

- In a project, the positive trend to see the students from the first academic partner trained by the students from the second academic partner,
- The main skills that the involvement into a PLACIS project allowed to acquire or develop (from a survey conducted on students involved in the first semester 2013-2014, N=24) are: engineering skills (87.5% of students), technical skills (62.5%), and relationship skills (62.5%),
- The possibility to work in an international context and in collaboration with foreign students is really appreciated,
- Very few problems (especially in communication area despite of the distance between students) between students and groups of students, but a feedback that pointed out a lack of investment of some industrial partners, the result being for example a delay in the work of the students.

We are conscious that the assessment could be better in PLACIS. In order to ensure that, it is planned to re-define the intended learning outcomes. There are already several proposals:

- Working on the syllabus and redefining competencies to be reached,
- Linking each competency to a level to be reached,
- Taking into account foreign approaches and comparisons, like Lunev, Petrova and Zaripova did in their comparison of European and Russian competence-based models [6] which can help PLACIS projects for Master students, or like Esparragoza, Lascano and Nuñez did in their presentation of their project done with the first year engineering students [7].

From new competencies and learning outcomes, it will become easier to redefine assessment methods and make them clear for the students since the beginning of their involvement.

In order to illustrate what PLACIS is concretely, we will now focus on one of the projects running in this framework: the development of a Modelica library for the preliminary design of electric

powertrains, made in collaboration between IM-CNR, UNINA and IPGP, institutions already presented earlier in this paper.

### 3 Illustration with: Development of a Modelica library for the preliminary design of electric powertrains.

#### 3.1 Description

Istituto Motori of the National Research Council of Italy (IM-CNR), since its foundation during the Second World War, focuses its research activity on the fields of energy conversion and environmental protection. One of its research activities is the efficiency-improving technologies to achieve either better fuel economy or better performance of urban transportation systems. IM-CNR builds test-benches for experimentation of electric powertrains and hybrid-electric powertrains. However, generating experimental data is time consuming and should be economically justified because of high costs. Therefore, a good solution is to combine experimentation with simulation in order to explore more technical solutions.

#### 3.2 Objectives

In this paper, we focus on the development of a Modelica library for the preliminary design of electric powertrains, which could be also used for the study of hybrid-electric powertrains. This work was performed by a group of three students: two students from ISMEP-Supméca and one student from Università di Napoli Federico II (UNINA), who is having his internship in IM-CNR. The project was supervised by three tutors, one from each institution.

#### 3.3 Methods

In order to coordinate the tasks, the three students used to work on two levels: a system level and a component level. On the system level, the students define the architecture of an electric vehicle to fix the required components, the interfaces and the connections between components.

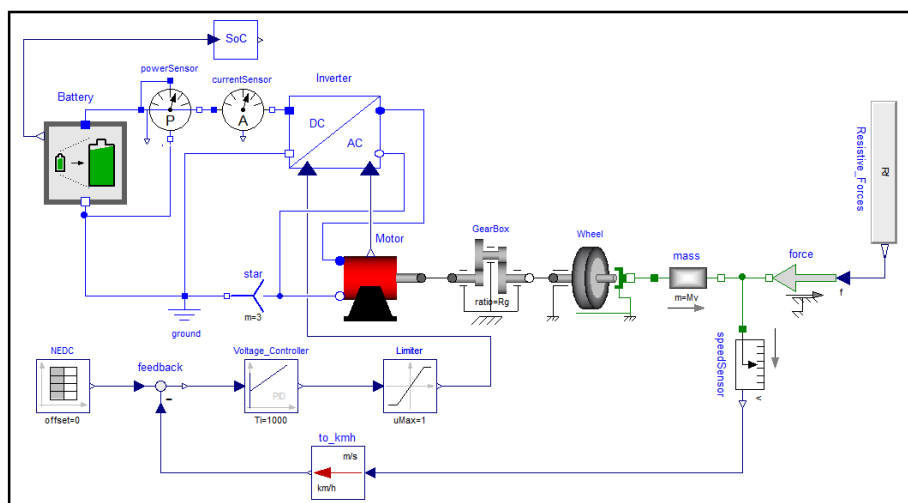

Figure 2: Electric vehicle model developed with Modelica



The electric vehicle model has been modelled using Modelica language [8]. This model is composed of the following components (figure 2): a battery (DC voltage source), a DC-AC inverter, an electric machine (electric synchronous motor), a transmission model, a resistive force and a control system. A current sensor, a power sensor, a speed sensor and a SoC component are respectively used to measure the electric current generated by the battery, the electric power required by the motor, the vehicle velocity and the State-of-Charge of the battery.

The interfaces are defined with connectors containing the physical variables to be shared between components. For example, the DC interface contains the two variables voltage ( $v[V]$ ) and current ( $i[A]$ ). Using the same interfaces allows the students to easily connect the components to each other to make the whole system.

On the component level, every student works on one of the main components which are: the battery, the inverter and the electric motor. Therefore, each student looks for the mathematical models to be implemented and defines the internal architecture of the component. Depending on cases, the design of the components can be carried out just by using the standard Modelica library, by adding Modelica code or by combining Modelica codes with the use of the standard Modelica library.

### 3.3.1. Battery

The battery pack consists of the series and / or parallel association of elementary cells. In this paper the battery model is based on an AMP 20 Lithium Ion Cell. Figure 3 shows the model of the battery developed with Modelica.

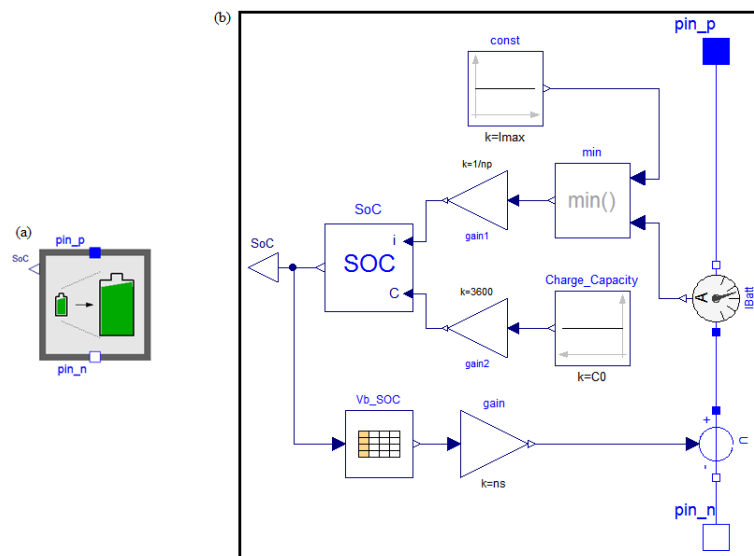

**Figure 3:** Battery model developed with Modelica: (a) External model, (b) Internal model

This model is made up of blocks which are in the Modelica library. The main objective of this model is to provide a voltage between the two ports of the battery  $pin_p$  and  $pin_n$  to simulate the real behaviour. The voltage  $U$  generates a current measured with the *CurrentSensor*. This current is compared with the allowable current  $I_{max}$ . The minimum of these two currents is divided by the number of parallel cells  $N_p$  in order to obtain the current in each cell (represented by  $gain1$ ). The current from one cell  $i$  flows in the block *SOC*. The other input of this block is the battery capacity  $C$  expressed in  $A.h$  ( $gain2$  is necessary to make a unit conversation: from  $A.s$  to  $A.h$ ).

The block *SOC* calculates the state-of-charge with the equation:

$$SOC = \int i(t) / C dt \quad (3.1)$$

The instantaneous value of the *SOC* is an entry in a table *Vb\_SOC*, which provides the voltage of a battery cell. This value, multiplied by the number of series cells *Ns* (represented by *gain3*), is used as a reference for generating the voltage of the battery.

### 3.3.2. Inverter

The model of the inverter was developed using a computational code that basically performs the conversion of DC current into an AC current based on the balance between input power, which comes from the battery, and output power, which is delivered to the motor. As it can be seen in figure 4 (a), the model is composed of four pins and two input connectors. The pins *n* and *N* are linked to the ground; the pins *p* and *P* are responsible for the connection with the battery and the electric motor, respectively. The first connector *a* represents the control input signal used to regulate the three-phase voltage amplitude and the second connector *we* is the electric angular frequency of the motor.

The mathematical model of the inverter is developed in figure 4 (b). It can be seen that there is only one editable parameter, which is the inverter efficiency *nu*. The other variables are used just as calculation tools of the voltage, the current and the power at the input and the output of the inverter.

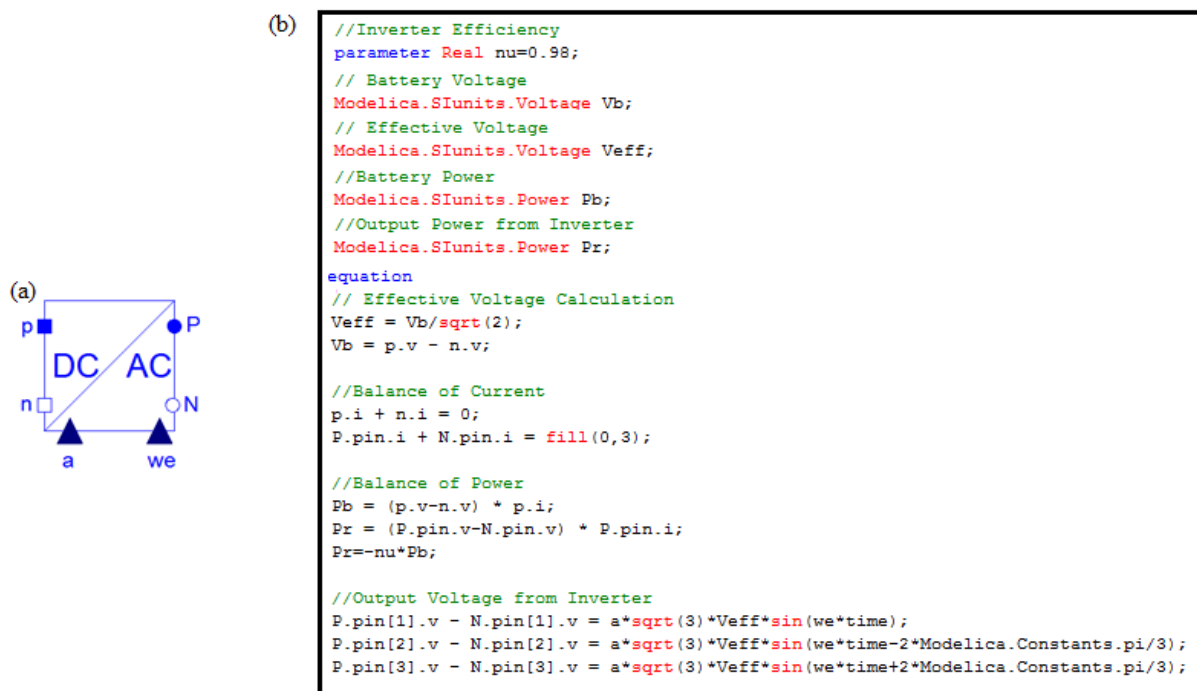

**Figure 4:** Inverter model developed with Dymola: (a) External model, (b) Internal mathematical code

### 3.3.3. Electric Synchronous Motor

The model of the motor represents the transition between the electrical and mechanical levels. As seen in figure 5 (a), the model is composed of two pins and two output connectors. The pins *P* and *N* are linked to the inverter and the ground, respectively. The mechanical connector *flange\_a* is responsible for the connection with the gearbox, which delivers two outputs: the torque (*flange\_a.tau*) and the motor shaft angle (*flange\_a.phi*).

The variable  $we$  is the third output of the model and consists of the electric angular frequency requested by the motor to reach the requirements of the driving cycle. It's important to point out that this output connector is linked with the parameter  $we$  of the model of the inverter, described and explained previously.

Therefore, the mathematical basis of the engine model was developed relating the mentioned parameters to the equations of the motor electric circuit and output mechanical connector.

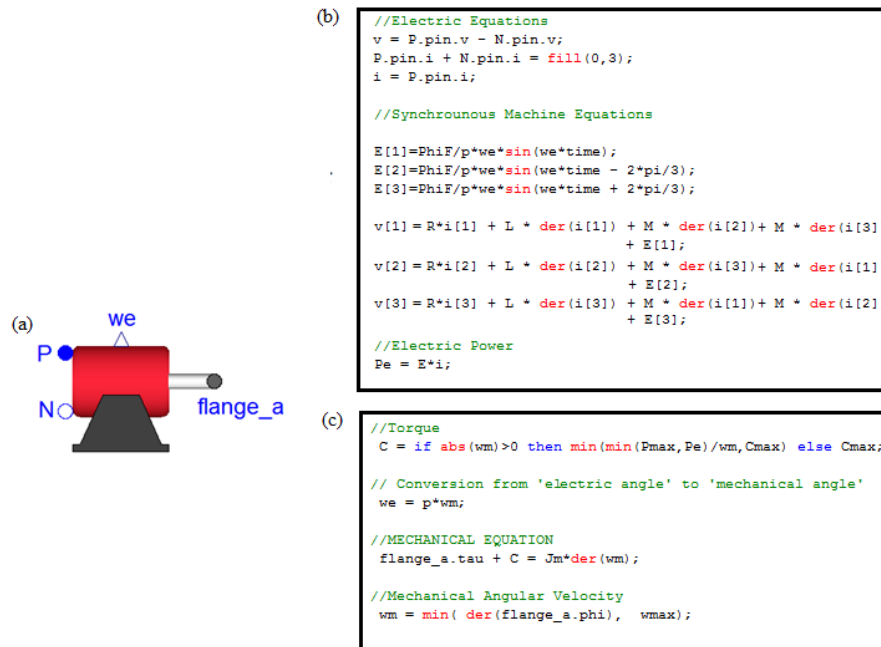
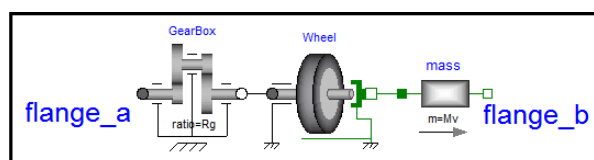

**Figure 5:** Electric Synchronous Motor developed with Modelica: (a) External model, (b) Characteristic equations of the electric motor, (c) Specification of the outputs of the electric motor

The open electric circuit of the motor is composed of a resistor  $R$ , which represents the internal losses of the machine, an inductor  $L$  and a mutual inductance  $M$ . The equations that govern the behaviour of the motor are developed in figure 5 (b). The output variables of the model are indicated in figure 5 (c).

### 3.3.4. Transmission System

The transmission model is shown in figure 6. It is composed of an ideal gear block, a component to model the wheels and a translating mass.



**Figure 6:** Transmission model of the electric vehicle

### 3.3.5. Resistive Forces

This part is made up of two blocks, as shown in figure 7. The first block consists of a mathematical expression that calculates the resistive force according to the instantaneous speed of the vehicle and the second block gets the generated result and transform it into a response force, which is applied to the last part of the transmission system.

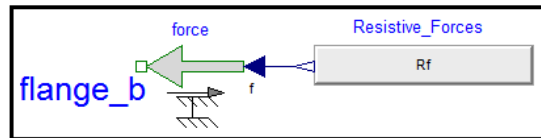

**Figure 7:** Resistive Forces

The equation of the resistive force is given by:

$$R_f = \frac{1}{2} \cdot C_d \cdot \rho \cdot A_{front} \cdot V^2 + C_{ro} \cdot M \cdot g \cdot \cos(\alpha) + M \cdot g \cdot \sin(\alpha) \quad (3.2)$$

Where  $R_f$  is the resistive force,  $C_d$  is the aerodynamic drag coefficient,  $\rho$  is the air density,  $A_{front}$  is the vehicle frontal area,  $V$  is the vehicle velocity,  $C_{ro}$  is the rolling coefficient,  $M$  is the vehicle mass,  $g$  is the gravitational acceleration constant and  $\alpha$  is the grade angle.

### 3.3.6. Control System

The Control System is composed of two inputs (reference speed and calculated speed) and one control parameter (inverter voltage control coefficient), as shown in figure 8.

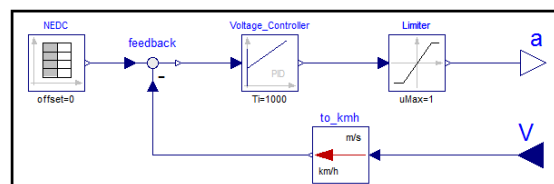

**Figure 8:** Control System of the electric vehicle

Then, the proportional-derivate control system (*Voltage\_Controller*) uses the difference between the input reference speed and the instantaneous speed, calculated by the model, to calculate the parameter  $a$  to fit the voltage required by motor.

### 3.4. Simulation results

To reproduce a road path with different driving conditions, the New European Driving Cycle (NEDC) has been used in this study. The default configuration of the considered parameter values is given in table 3.

Parameters	Description	Value	Unit
$M$	Vehicle mass	1540	$Kg$
$\rho$	Air density	1.2	$Kg.m^3$
$A_{front}$	Vehicle frontal area	1.8	$m^2$
$C_{ro}$	Rolling coefficient	0.2	-
$C_d$	Aerodynamic drag coefficient	0.013	-
$\alpha$	Grade angle	0	$rad$
$g$	Gravitational acceleration constant	9.81	$m.s^{-2}$
$r_w$	Wheel radius	0.28	$m$
$R_g$	Gearbox ratio	6	-
$Emf$	Constant of the electromotive force	0.5	$Nm/A$
$nu$	Inverter efficiency	0.98	-

$N_s$	Number of series connected	75	-
$N_p$	Number of parallel strings	4	-
$SoC_{init}$	Initial state of charge	0.8	-
$V$	Speed vehicle	Variable	km/h
$SoC$	State of charge	Variable	-

**Table 3:** Electric vehicle parameters

Results shown in figure 9 indicate a good agreement between the input driving cycle and the output vehicle velocity. Figure 10 shows the variation of the  $SoC$  during the NEDC cycle. The first  $SoC$  was 80%. The operating range is between 80% and 67%, i.e., the battery has lost 16.25% of its capacity during the NEDC cycle.

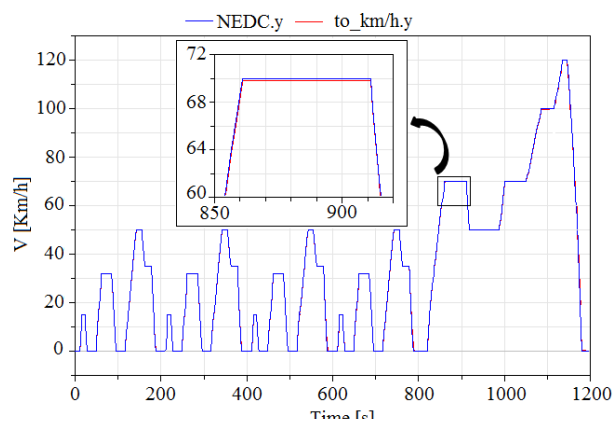
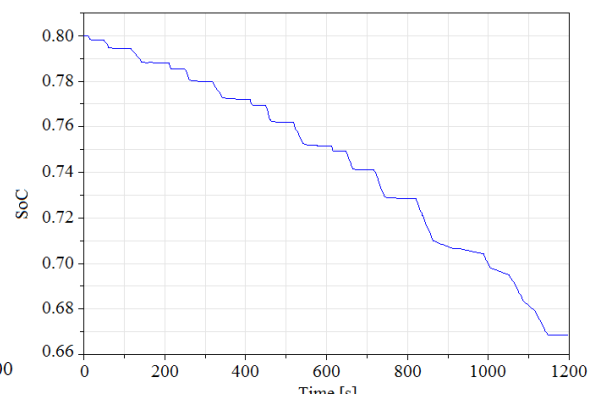
**Figure 9:** Comparison between input NEDC and output vehicle velocity**Figure 10:** State-of-Charge for NEDC profile

### 3.4 Results

The obtained Modelica library is now under evaluation by comparison between simulation results and experimental results generated on the test-benches of IM-CNR. The first comparisons on the electric current and voltage in the battery show a good agreement. However, this project is still in progress to ameliorate the accuracy of models and to include other components to be able to simulate hybrid-electric powertrains.

PLACIS and especially this project enabled us to strengthen our partnerships with UNINA and IM-CNR, both on education level and on research level. Students' exchanges between UNINA and ISMEP-Supméca have risen and many students take advantage of these partnerships to have an internship at IM-CNR. In the same way, papers on topics like the RFLP approach are jointly published by people from these institutions [9]. This is a real example of win-win-win cooperation, also strengthened by a new European project launched in parallel to PLACIS.

## 4 Conclusion

PLACIS still has two years of funding by the French National Agency for Research. One of our priorities is to sustain the platform and its projects. It is for this reason that we have a strategy of

platform development at European level and that we search new skills in educational sciences beyond our borders.

For these reasons, and particularly in order to meet the challenge of teachers' involvement in PmBL and PtBL (and in the use of new tools), we launched a new project in parallel to PLACIS. This project, called EPICES<sup>2</sup> (European Platform for Innovation and Collaboration between Engineer Students), started in September 2014 and is funded in the framework of the Erasmus+ program. EPICES will allow developing a European collaborative at-a-distance PtBL framework and method, based on already existing and still developing technical platforms, i.e. collaborative and engineering tools.

A special focus will be made on teachers' role and students' coaching, from the analysis of what a coach should be in PtBL to training packages for teachers and development of assessment methods. EPICES aims to provide data, results and guidelines on PtBL in engineering to the whole community, making the implementation of PtBL easier for institutions and, especially, for teachers.

ISMEP-Supméca (coordinator of EPICES) and EPICES partners (Aalto University, Riga Technical University, KU Leuven, Politecnico di Torino, Università di Napoli Federico II, Universitat Politècnica de Valencia, SEFI) will carry out this project, with the ambition to reach the established goals, and, then, to go further and launch a Knowledge Alliance project in September 2016 to explore some issues resulting from EPICES and PLACIS deeper. Taking into account what we see in PLACIS and EPICES and following the remarks made by Beddoes, Jesiek and Borrego in 2010 in their analysis of research in problem- and project-based learning, we continue to think that "assessment methods and strategies are one possible avenue for fruitful international research collaboration" and we keep it in mind that even if there have been convergences since 2010, "some aspects of PBL remain context dependent" [10], first EPICES results confirming this assertion.

## Références

- [1] "Rapport sur la mission compétences systèmes pour le pôle de compétitivité System@tic Paris Région", Cabinet CarTesa
- [2] A. François, A. Lanthony, "Work-in-Progress: Collaborative Platform for Systems Engineering: Active learning to train engineer students through projects", International Conference on Interactive Collaborative Learning (ICL), Dubai, 2014, pp. 1043-1048, DOI: 10.1109/ICL.2014.7017926
- [3] M.J. Prince, R.M. Felder, "Inductive Teaching and Learning Methods: Definitions, Comparisons, and Research Bases", Journal of Engineering Education, 95(2), 2006, pp. 123-138, DOI: 10.1.1.62.8102
- [4] T.A. Ward, "Common elements of capstone projects in the world's top ranked engineering universities", European Journal of Engineering Education, vol. 38, No. 2, 2013, pp. 211-218, DOI: 10.1080/03043797.2013.766676
- [5] A. Fox, "From MOOCs to SPOCs", Communication of the ACM, vol. 56, No. 12, 2013, pp. 38-40, DOI: 10.1145/2535918
- [6] A. Lunev, I. Petrova, V. Zaripova, "Competency-based models of learning for engineers: a comparison", European Journal of Engineering Education, vol. 38, No. 5, 2013, pp. 543-555, DOI: 10.1080/03043797.2013.824410

---

<sup>2</sup> With the following reference: 2014-1-FR01-KA203-008560.

- [7] I. Esparragoza, S. Lascano, J. Nuñez, “A project-based learning approach for a first-year engineering course”, 11th Latin American and Caribbean Conference for Engineering and Technology, Cancun, 2013
- [8] P. Fritzson, Principles of object-oriented modeling and simulation with Modelica 2.1, John Wiley & Sons, 2010
- [9] C. Capasso, M. Hammadi, S. Patalano, R. Renaud, O. Veneri, “RFLP Approach in the Designing of Power-Trains for Road Electric Vehicles”, Multiphysics Modelling and Simulation for Systems Design and Monitoring, 2015/1/1, pp. 249-258, DOI: 10.1007/978-3-319-14532-7\_26
- [10] K.D. Beddoes, B.K. Jesiek, M. Borrego, “Identifying Opportunities for Collaboration in International Engineering Research on Problem- and Project-Based Learning”, Interdisciplinary Journal of Problem-based Learning, vol. 4, No. 2, 2010, pp. 7-34, DOI: 10.7771/1541-5015.1142