



HAL
open science

Modelling long-term and short-term temporal variation and uncertainty of electricity production in the life cycle assessment of Buildings

Marie Frapin, Charlotte Roux, Edi Assoumou, Bruno Peuportier

► To cite this version:

Marie Frapin, Charlotte Roux, Edi Assoumou, Bruno Peuportier. Modelling long-term and short-term temporal variation and uncertainty of electricity production in the life cycle assessment of Buildings. Applied Energy, 2021, 10.1016/j.apenergy.2021.118141 . hal-03442141

HAL Id: hal-03442141

<https://hal.science/hal-03442141>

Submitted on 23 Nov 2021

HAL is a multi-disciplinary open access archive for the deposit and dissemination of scientific research documents, whether they are published or not. The documents may come from teaching and research institutions in France or abroad, or from public or private research centers.

L'archive ouverte pluridisciplinaire **HAL**, est destinée au dépôt et à la diffusion de documents scientifiques de niveau recherche, publiés ou non, émanant des établissements d'enseignement et de recherche français ou étrangers, des laboratoires publics ou privés.

Modelling long-term and short-term temporal variation and uncertainty of electricity production in the life cycle assessment of Buildings

Marie Frapin¹, Charlotte Roux², Edi Assoumou³, Bruno Peuportier^{1}*

1 MINES ParisTech, PSL – Research University, CES – Center of Energy Efficiency of Systems, 60 Bd St Michel, 75006 Paris, France

2 EIVP, 80 rue Rebeval, 75019 Paris, France

3 MINES ParisTech, PSL – Research University, CMA – Center of Applied Mathematics, , France

[*bruno.peuportier@mines-paristech.fr](mailto:bruno.peuportier@mines-paristech.fr)

KEYWORDS: Electricity production, Prospective scenarios, Life cycle assessment, Buildings

ABSTRACT: The building stock is a major contributor to energy consumption and greenhouse gases emissions (GHG), which can be evaluated using life cycle assessment (LCA). Electrification of buildings, e.g. replacing fuel and gas boilers with heat pumps, in order to reduce these emissions is often seen as an option, but this will have short term effects by increasing peak demand, and long term effects by requiring more electricity production capacities. In this paper, a methodology to account for such interaction in LCA is presented. It

connects three models addressing: market allocation on a national scale over a long term period, short term variation (i.e. seasonal, daily and hourly) of the electricity mix also on a national scale, and building energy simulation at the scale of one building. This methodology has been applied to a case study including a sample of buildings in the French context, but it can be used in other countries. Six buildings have been studied over 100 years considering 50 energy transition scenarios. Results show that the environmental impacts vary more depending on the scenarios than on the types of the building . Marginal mixes considered in consequential LCA are mainly composed of coal, gas, nuclear and peak technology production which explains the highest values of the different impacts compared to average mixes used in attributional LCA. This approach allows to address uncertainties related to electricity production.

1. INTRODUCTION

Buildings consume over 55% of worldwide electricity production (IEA 2019), with a major impact on said production particularly during peak demand induced by e.g. space heating and cooling. The share of electricity in energy use in buildings is rising and this trend is likely to continue according to energy transition policies. Electricity can also be produced in buildings and exported to the grid, leading then to temporal variation of electricity production especially in the case of photovoltaic systems. On the other hand, the electrical system influences the environmental balance of buildings and in some cases the control of equipment according to demand-side management.

This interaction between buildings and electricity production has short term effects, depending on e.g. climatic conditions, but also long term consequences because a planned energy transition policy in the building sector (e.g. substituting oil boilers for heat pumps, or promoting

renewable production) may induce the implementation of new production capacities over the years.

Accounting for such interaction in LCA is complex, and requires either simplified assumptions which may not be always reliable, or significant modelling work. Attributional LCA, considering an average annual mix corresponding to a recent past period is generally used in most building LCA studies.

The interest of using consequential LCA, considering both long term marginal technologies and short term marginal supply, was shown in (Lund et al. 2010) in the case of the Danish electricity system. The significance of short term variation of the electricity mix was confirmed by further studies in many countries like Finland (Soimakallio et al. 2011), France (Herfray and Peuportier 2012), Canada (Amor et al. 2014; Pereira and Posen 2020), Belgium (Messagie et al. 2014), New Zealand (Khan et al. 2018), Switzerland (Vuarnoz and Jusselme 2018) and Spain (Victoria and Gallego-Castillo 2019).

Accounting for short term variation of the electricity mix in LCA applied to buildings requires coherent assumptions, and particularly climatic data, when evaluating the energy consumption for space heating and cooling, and when evaluating the electricity supply mix. Models of the electricity system were therefore developed by (Herfray and Peuportier 2012), and (Roux et al. 2016b). Considering a constant electricity production mix over a year may be valid in certain countries but e.g. in France, the mix varies across the season, the day of the week and the hour of the day: direct Greenhouse gases emissions varied from 7 to 91 g CO₂/kWh in year 2018, according to the data of the French Transmission System Operator (RTE).

Long-term evolution of the electricity mix over a 20 years period has been taken into account in the LCA of renewable energy technologies, using a scenario developed for the German

Environmental Protection Agency (Pehnt 2006). A Market allocation model has been used to study the evolution of the Chinese electricity mix and related environmental impacts until 2050 (Tokimatsu et al. 2016). A high temporal resolution TIMES model has been used to elaborate two scenarios (business as usual and high carbon tax) in France, which were combined with two climate change scenarios (RCP 4.5 and RCP 8.5) and used in a building LCA model over 50 years and accounting also for short term variation (Roux et al. 2016a). A TIMES energy model, in which two prospective scenarios have been implemented (business as usual and 80% reduction in CO₂ emissions by 2050 with respect to 2005 levels), has been used to study the evolution of the Spanish electricity mix from 2014 to 2050 (García-Gusano et al. 2017a). Short term and long term variation have also been modelled using an hourly economic model in Hungary by (Kiss et al. 2020) and three scenarios have been compared.

The innovation of this study lies in taking into account both short and long term variations in electricity production mix in the LCA of buildings using a market allocation model so that 48 scenarios were derived, allowing to address uncertainties in LCA results. The market allocation model is based on variable parameters like the level of a CO₂ tax, the decrease of renewable energy prices and the acceptance of some technologies. It provides a typical mix for every five years from 2030 to 2060 for two days of each month and 24 hours, and allows both gas and electricity systems to be combined. Because political decisions are not always based upon economical optimisation, a scenario which is not based upon a market allocation model is also considered, as well as a scenario corresponding to the near future (2020-2025). LCA of a sample of buildings (residential and offices with various energy performance levels) is performed on this basis, and impacts are evaluated for different electricity uses (heating, cooling, domestic hot water etc.). The objective of this work is threefold. First, it is to evaluate

uncertainties in building LCA related to future evolution of the energy system, in different methodological contexts (e.g. attributional vs consequential LCA). Second, it is to assess sensitivity of this future evolution relatively to end-uses in buildings and building types (e.g. old, new, energy positive). Finally, it is to provide recommendations for building eco-design assessments.

The methodology is first introduced regarding the elaboration of prospective scenarios as well as the improvement of the model addressing short term variation of the mix. Results on a case study are then exposed, showing how various LCA indicators (CO₂ but also radioactive waste, damages on health and biodiversity) are influenced by the scenarios and LCA method: attributional or consequential. Limitations, uncertainties and recommendations are addressed in the discussion session followed by conclusions and research perspectives.

2. ELABORATION OF PROSPECTIVE SCENARIOS

2.1. The TIMES-FR GAZEL model

The energy system which is often considered as a background system will be radically transformed over the time scales of interest for LCA analyses. The current power mix is thus not a proper reflection of the future context in which a given building system will operate, and it is necessary to properly account for its transformation. This prospective dimension should capture the decommissioning rhythm of existing plants and their replacement by new technologies depending on the energy policy targets. It must also include a fair description of the load following challenges. Given the seasonal and daily variability of solar or wind technologies, this will impact the emission factors for different uses in the building sector. In our analysis the

TIMES-FR GAZEL.V2 model was used to derive a consistent set of future trajectories for the power generation and gas supply sectors until 2060.

TIMES models are a class of bottom-up linear optimization models that computes a least cost pathway for a system of interest subject to the satisfaction of specified service demands and user specified constraints (García-Gusano et al. 2017b) (Ortega et al. 2020) (Amorim et al. 2020) (Loulou et al. 2016). Compared to the earlier work in (Roux et al. 2016a), the TIMES-FR GAZEL.V2 model used in this analysis includes a completed description of the interaction with the gas supply system. This allows for systemic description of gas-to-power and power-to-gas interactions (Doudard 2018). It also includes a new description of flexibility options on the demand-side which influence the penetration of renewables and the shape of the load.

Figure 1 describes the overall structure of the model. The lower panel describes the power system and the competition between technologies to supply the demand. The upper panel depicts the gas supply system and the competition between natural gas and bio-methane routes. Both systems interact first via the gas-to-power option where the resulting gas mix can be used for electricity generation by gas fueled plants. They also interact via the possibility offered by power-to-gas. Hydrogen is then produced by electrolysis and injected directly in the gas grid or converted into synthetic methane using CO₂ through a methanation step.

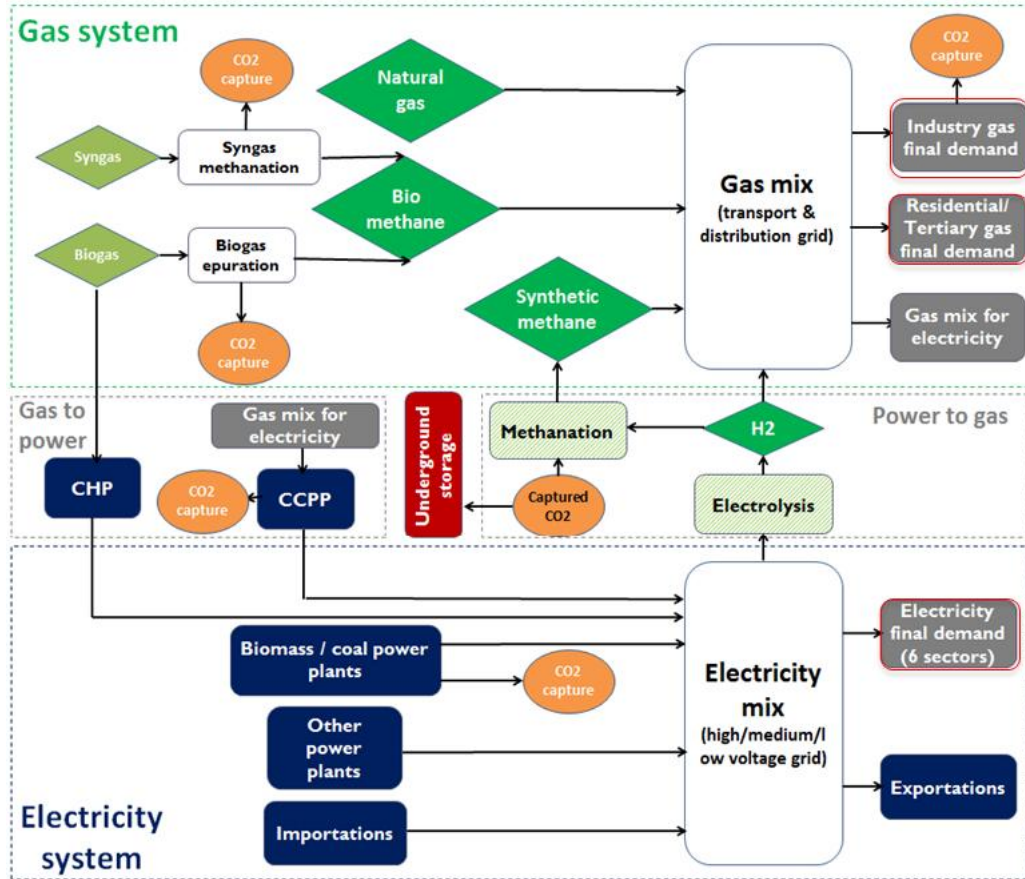

Figure 1. Principle of the market allocation model GAZEL

Our analysis covers the period 2012-2060 with a 5-year time step. Each period is further decomposed in 12 months, 2 day types (working days and week-ends), and 24 h per day type. This time resolution allows for a better representation of the impact of variable renewable sources.

For each future year, demand levels per end-use sector have been extracted from the central visions of the medium-term prospects produced by the French electricity (RTE 2017a) and gas (GRTgaz et al. 2017) TSOs. For the period 2017-2035 they respectively project a 7 and 12% decrease of demand. These trends have been maintained up to 2050. After 2050 the volume of demand remains constant. The description of future demand is completed at the sub annual level

by the introduction of intraday demand side flexibility options. As depicted by **Figure 2**, 3 types of flexibility options are considered: the substitution of gas demand by electricity demand, the possibility of shifting the load via demand response, the possibility of curtailing the load at a cost corresponding to the value of lost load. Introducing these flexibilities options affects the electricity impact factors for various periods of the day as it reduces the load following constraints in the investment choice problem.

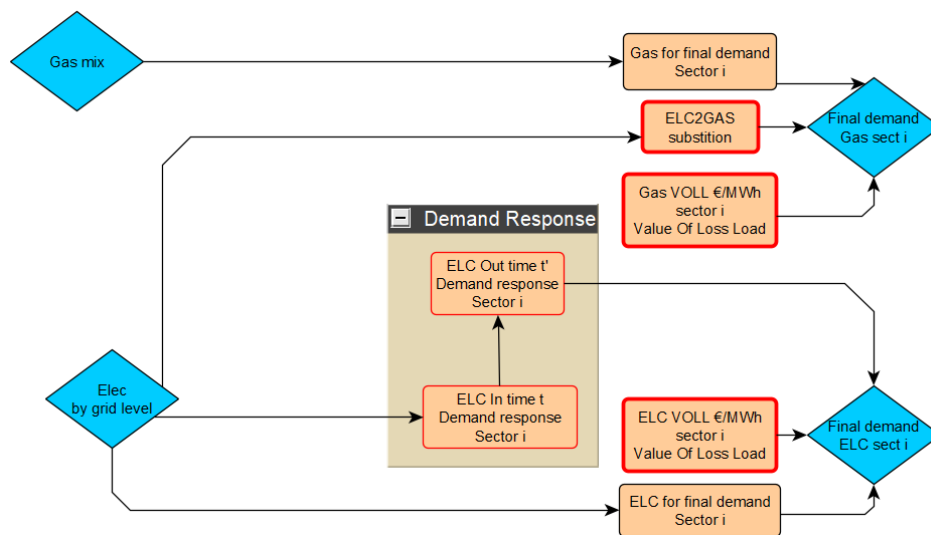

Figure 2. Demand side flexibilities

2.2. Screening approach and key dimensions of scenarios

A counterpart of integrating the transformations of the background energy system in the LCA analysis of buildings is an increase in complexity with pure economic parameters playing a potentially crucial role. Most of the changes will be linked to the relative competitiveness of the technologies or mitigation policies. The LCA analysis of a building will then for instance depend on the competition between gas, future PV costs and the rhythm of decommissioning of nuclear. To derive useful indicators for practitioners, we propose to reduce this complexity by screening

different scenarios explicitly defined according to 3 key dimensions and constructing a knowledge database.

The first key dimension describes the nature and intensity of the environmental policy. Four levels of increasing ambitions have been considered to cover a large range of possible conditions:

- E1: a moderate carbon penalty reaching 30€/tCO₂ in 2030 and remaining constant afterward;
- E2: a higher penalty that follows the profile expressed in the reference EU scenario (European Commission 2016). The CO₂ penalty then reaches 50€/tCO₂ in 2040 and 100€/tCO₂ in 2060;
- E3: a carbon neutrality target for the power and gas sectors by 2060;
- E4: a more ambitious scenario with a neutrality reached in 2050.

The first two environmental policy settings define the level of accepted effort but not the outcome while the two carbon neutral policies explicitly control the emission levels.

The second key dimension reflects the level of optimism regarding the available technological options. Three options are considered for the supply side:

- “O1” reflects a situation where there is no constraint on the available technologies. However, to reflect the current energy law, the share of nuclear is limited to 50%;
- “O2” is a scenario that does not allow carbon capture and storage as an option. It extends the current difficulty to concretely move to massive CCS in France.

- “O3” further reduces the available technology portfolio with no new nuclear reactors.

On the demand side, the case “D1” assumes a wide acceptance of demand control technologies by end-users. The potential of demand-response is set at 26 GW for decentralized sources (Kassara et al. 2019) and up to 4.3 GW (RTE 2017b) for industrial sites.

Finally, in a third key dimension, a reference (“C1”) and a very aggressive investment cost reduction scenario of solar and wind technologies (“C2”) are considered (**Figure 3**).

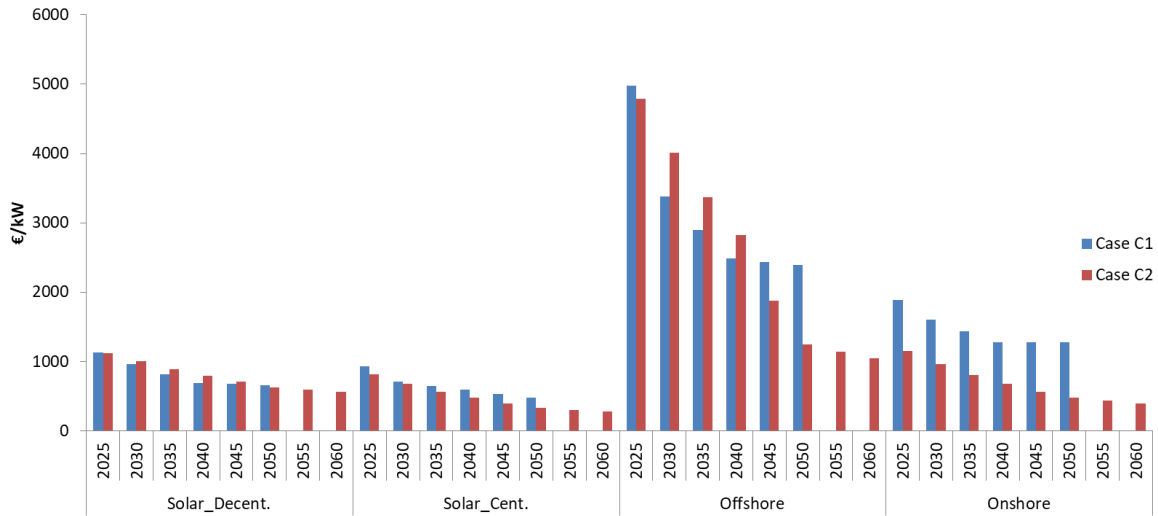

Figure 3. Reference and aggressive cost reduction assumptions

To map a wide range of possible future contexts, a set of 48 scenarios was then constructed by combining the different key dimensions where e.g. E3O4D1C2 reflects the case of a carbon neutrality in 2060 with no nuclear or CCS, a wide acceptance of demand-response options and an aggressive cost reduction of renewables.

3. ELECTRICITY MIX MODEL

3.1. Overview of the model

An electricity mix model had been previously elaborated to evaluate environmental impacts of electricity consumption and production from buildings or districts. This model has been presented in Roux (Roux et al. 2016b). It is a technology-explicit, demand-driven model simulating consumption and production of electricity in France for a reference year, averaging climatic and economic hazards of real years. The reference year corresponds to typical meteorological data such as used in building dynamic energy simulation and up-to-date installed capacities for electricity production in France. It ensures a consistent framework regarding the influence of the weather on both the building energy demand and the electricity production. The **Figure 4** summarizes the global architecture of the model and sub-models.

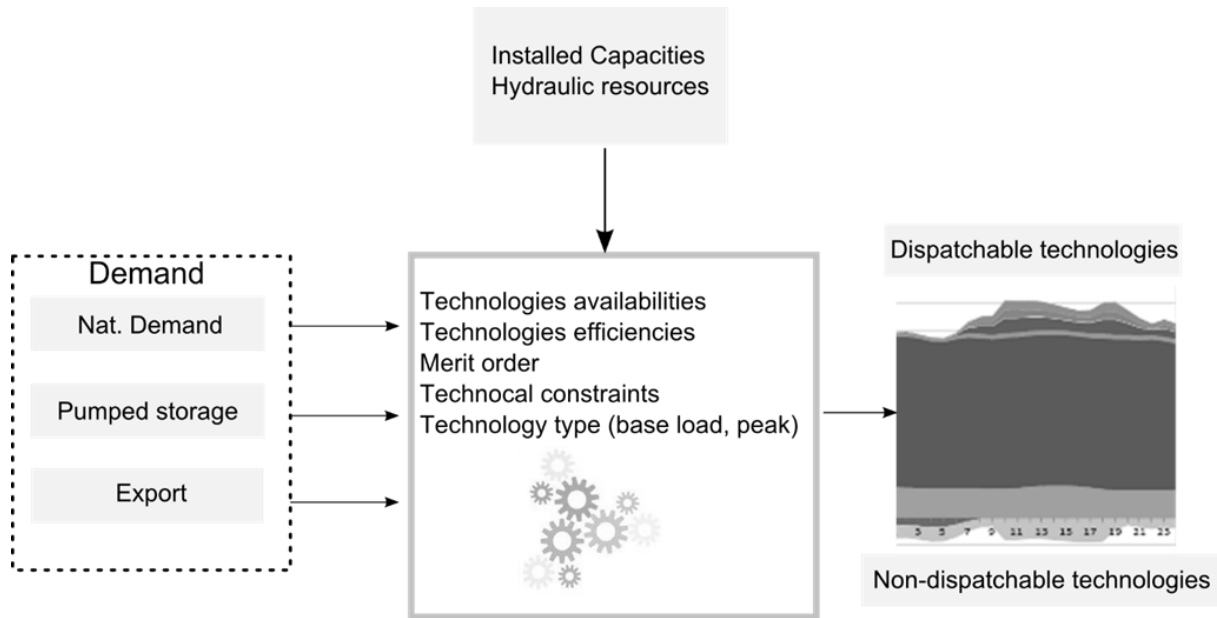

Figure 4. Overview of the electricity mix model (Peuportier et al., 2016)

The simulation runs in four steps: evaluation of the national electricity demand, evaluation of non-dispatchable production, addition of electricity demand from pumped storage and export and

evaluation of the dispatchable production. It allows an evaluation of short-term hourly impacts of electricity consumption using either an average or a marginal approach.

In this new study, the model has been updated and upgraded. It has first been validated on year 2017 in order to check if its reliability is stable compared to 2014 (validation year of the first model). It has then been updated to include 2014 to 2017 historical data for non-dispatchable production (bioenergy, decentralized combined heat and power plant, wind, solar etc.), and include the availability of centralized power plants (nuclear, gas and coal). The sub-model evaluating export and import has also been recalibrated (new training of the neural network) as part of the update step. Two upgrades of the model have been implemented: a linear link to the outside temperature has been integrated in order to modulate the decentralized non-dispatchable gas plants production and calendar information were added to the neural network inputs (export and import sub-model).

3.2. Update and upgrade validation results

Several validation steps are necessary to check the model reliability. Each sub-model is first evaluated separately and error propagation through the model is also checked in a second step. Various error metrics have been used: correlation coefficient to ensure the ability of sub-models to grasp the production variation properly, bias to avoid under or over estimation, and mean absolute error to avoid error compensation through the year.

The update of the model has an important effect on bias reduction as shown on **Figure 5** below. It is mainly explained by the very scarce historical data used in 2014 to evaluate non-dispatchable production. Only one or two years (depending on technologies) were available at that time.

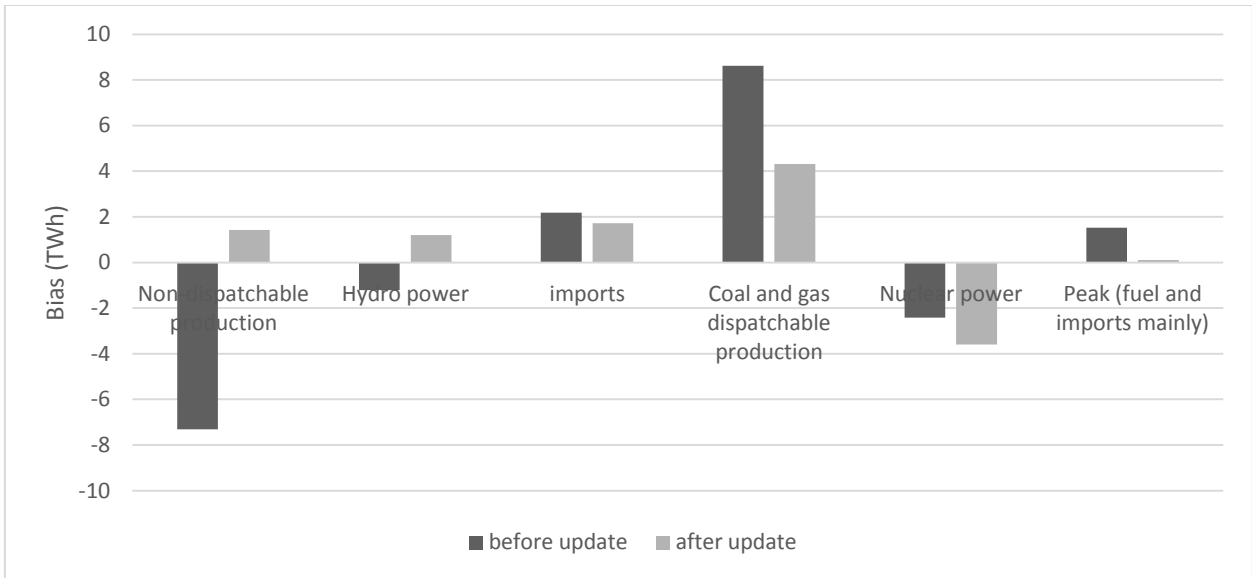

Figure 5. Bias comparison for year 2017 before and after update

Example effects of the two improvements integrated in the model are presented below regarding the gas power plants and import/export sub-models. This update allows a small but non negligible upgrade of the model performances, with a rise of the correlation coefficient and reduction in the number of errors.

Tableau 1. Decentralized non-dispatchable gas power plants sub-model upgrade

	Correlation coefficient	Mean Absolute error (MW)	Mean absolute percentage error (%)
Initial model (constant load factor)	0.54	164	5.8
Upgrade (load factor depending on temperature)	0.66	142	5.3

Tableau 2. Export and import sub-model upgrade (neural network)

		Calibration	Validation
Without calendar info.	COR	0,88	0,84
	MAE (MW)	1 460	1 824
Day – Month - Season	COR	0,91	0,87
	MAE (MW)	1 287	1 660

A synthetic overview of the model and sub-model performances is finally presented on **Figure 6**, showing the ratio of mean absolute error to the average power, in order to give less importance to technologies that are very small contributors to the electricity mix. All ratios are below 5% which is considered to be an appropriate level of performance considering the model applications.

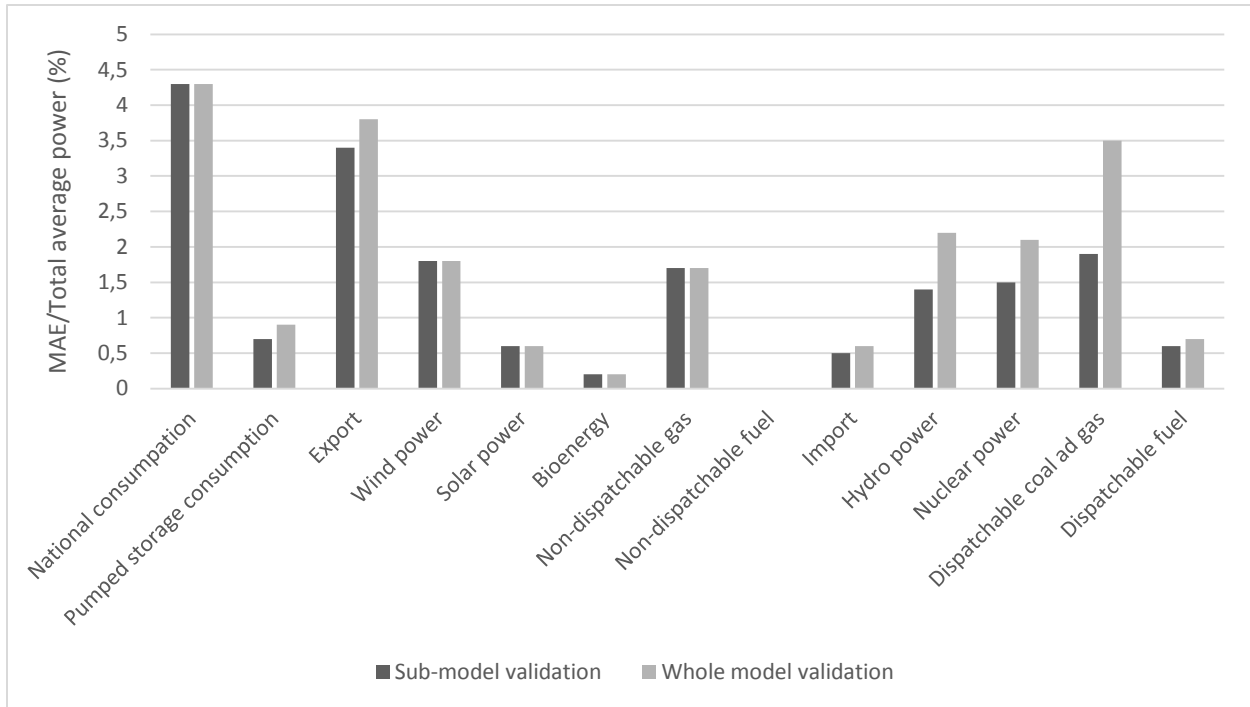

Figure 6. Model and sub-models validation on year 2017

3.3. Evaluation of environmental impacts of electricity consumption in buildings

Once the electricity production mix has been simulated, environmental impacts are evaluated using life-cycle assessment. Distinction between the average and marginal approaches in LCA are fully explained in Roux (Roux et al. 2016b) (2016). The average approach, associated to attributional LCA evaluates an average electricity mix for each hour of the reference year, which is then linked to technologies life-cycle impacts per kWh. Associated to consequential LCA, two marginal approaches are available. The first one evaluates a marginal electricity production using the electricity mix model to simulate an additional electricity demand. The second one uses the GHG Protocol (GHG Protocol 2007) procedure from a reference electricity production, ranking the technologies by merit-order and choosing a 10 % operational margin. The first one is more accurate but also time-consuming; the second one is fast, more flexible (adaptable to electricity

mix results from other models or scenarios) but less specific to a given project. Environmental impacts of electricity production technologies are evaluated using the ecoinvent v3.4 database. Network infrastructure and electricity losses are integrated.

4. CASE STUDY

The objective of this section is to assess the consequences of methodological choices on the results of an LCA applied to typical cases: old, new low-energy and positive energy office and residential buildings.

4.1. Buildings description

The studied building sample is made up of six office and residential buildings. Among the office buildings, two are located in the South of France (Mediterranean climate), one is a positive energy building the other is an old building (low insulation, single-glazed window). The third office building is an old one located in the Eastern part of France (continental climate). The residential buildings include a positive energy house, a low-energy and an old residential building, located near and in Paris (oceanic climate), respectively, and a low-energy building located in East of France.

The dynamic building energy simulation model COMFIE (Peuportier, 1990) was used to evaluate hourly electricity consumption and hourly photovoltaic production profiles of each building. Monthly consumptions are presented from **Figure 7** to **Figure 12**.

For the LCA calculations, a lifespan of 100 years was considered for the whole building and the structure, 30 years for windows and doors, 20 years for equipment and 10 years for painting.

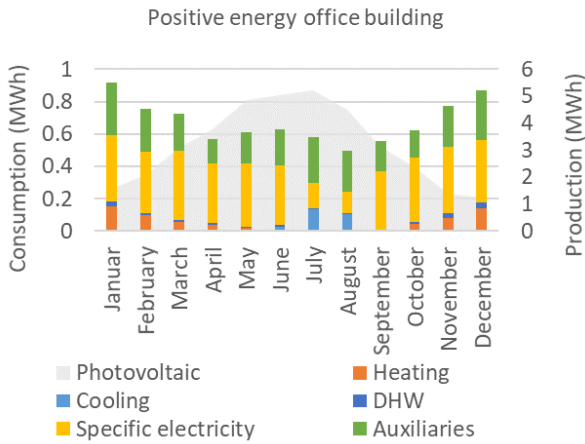

Figure 7. Monthly energy balance of the positive energy office

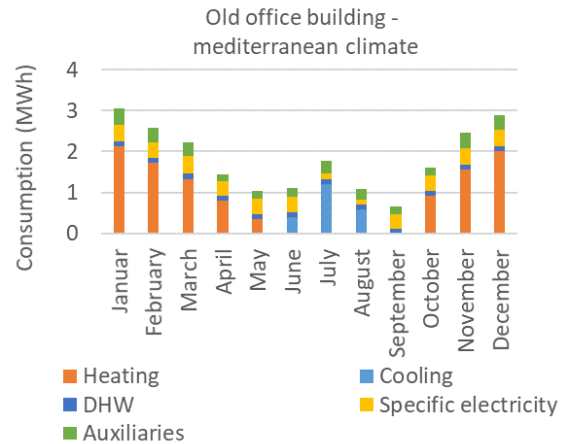

Figure 8. Monthly energy balance of the old office building located in the Mediterranean climate

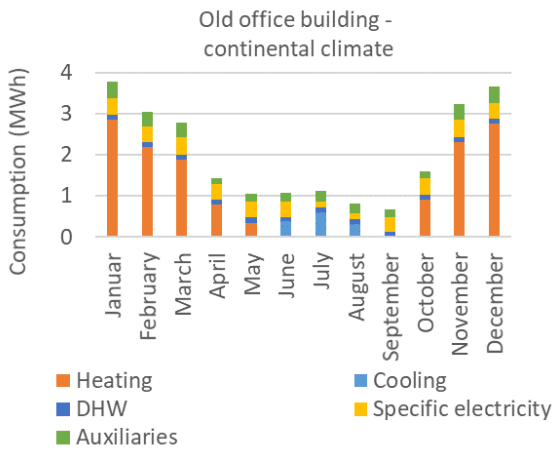

Figure 9. Monthly energy balance of the old office building located in the continental climate

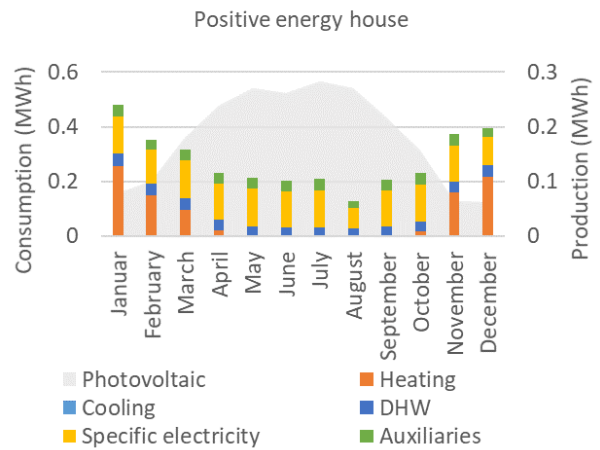

Figure 10. Monthly energy balance of the positive energy house

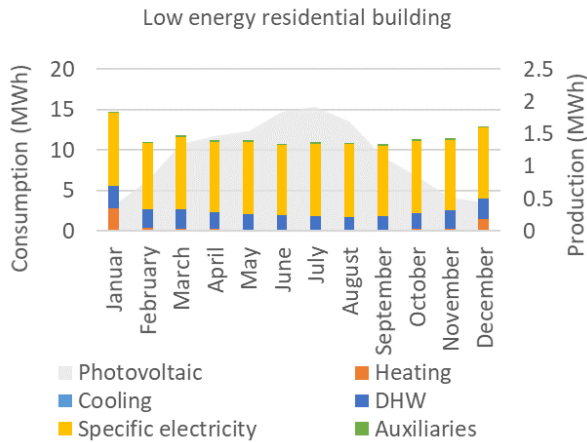

Figure 11. Monthly energy balance of the low energy residential building

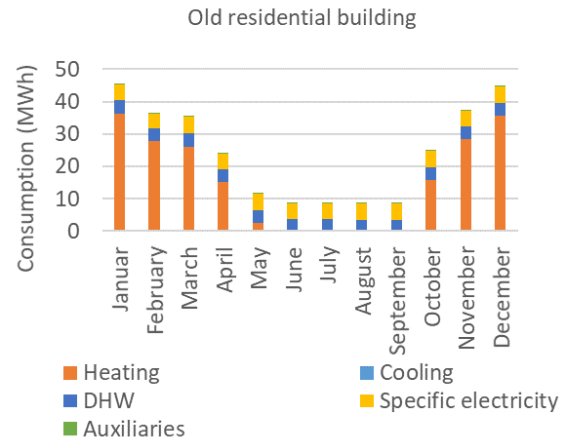

Figure 12. Monthly energy balance of the old residential building

4.2. Applied LCA

4.2.1. Definition of the trajectories

The aim of this study is to determine to what extent the LCA results on a sample of typical buildings are influenced when taking into account a temporal variation of environmental impacts based on the electricity mix trajectories defined in section 2 and 3. An additional electricity mix trajectory based on a prospective scenario elaborated by the French Environment and Energy Agency (ADEME) was also considered.

Figure 13 presents the time decomposition of the various electricity production trajectories using the electricity mix model and the prospective scenarios. A forecast scenario from RTE¹ forecast data was used for years 2020 to 2025² as input of the electricity model to define a short-term evolution of electricity mixes. The mix corresponding to year 2025 was used

¹ RTE : French Electricity Transmission System Operator (Réseau de Transport d'Electricité)

² https://www.rte-france.com/sites/default/files/bp2019_rapport_complet_1.pdf

until the end of the lifespan (cf. **Figure 13**, yellow trajectory). The objective is to constitute a reference, to which prospective scenarios can be compared.

Regarding the 48 prospective scenarios presented in section 2, the year 2020 mix was used to calculate the impacts of the first 10 years, then the year 2030 mix was used for the following 5 years and so forth until 2060. The year 2060 mix was used to calculate impacts from 2060 to the end of the building lifespan in 2120 (cf. **Figure 13**, blue trajectory).

Regarding the ADEME trajectory, the forecast scenario from RTE was used for year 2020 as input of the electricity model to calculate the impact of the first 15 years. The ADEME electricity mix of year 2035 was used for the following 15 years and the mix of year 2050 was used to calculate the impacts from 2050 to the end of the building lifespan (cf. **Figure 13**, green trajectory).

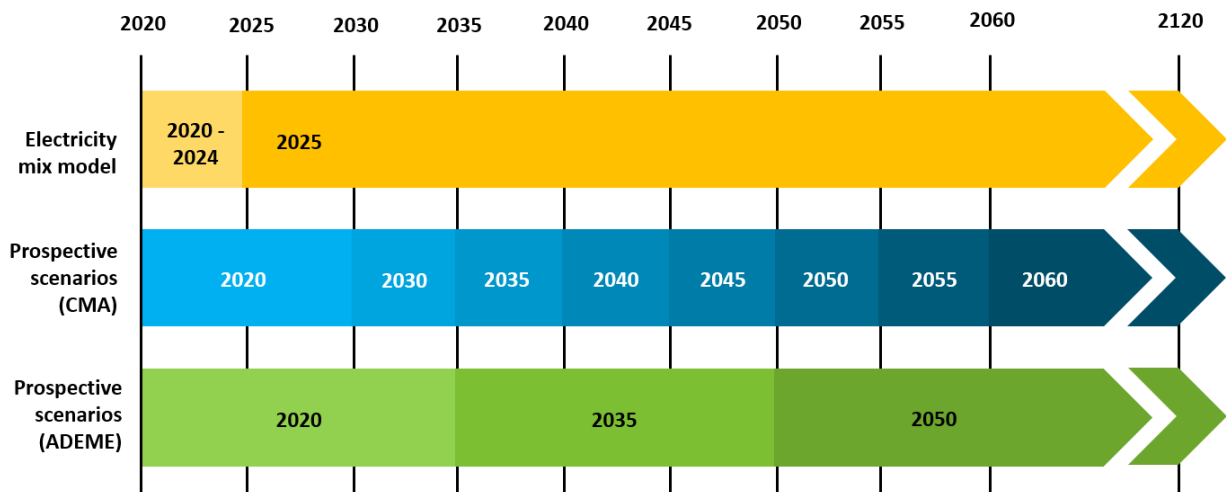

Figure 13. Time decomposition of electricity production trajectories

Figure 14 to **Figure 17** show the evolution of nuclear, fossil energy, hydraulic and renewable energy production shares for several trajectories: the RTE short-term forecast scenario, the prospective scenarios presented in section 2 (CMA C1 and CMA C2), and the scenario

elaborated by the French Environment and Energy Agency (ADEME). The minimum and maximum values for the CMA trajectories (24 scenarios) are presented using the error bars.

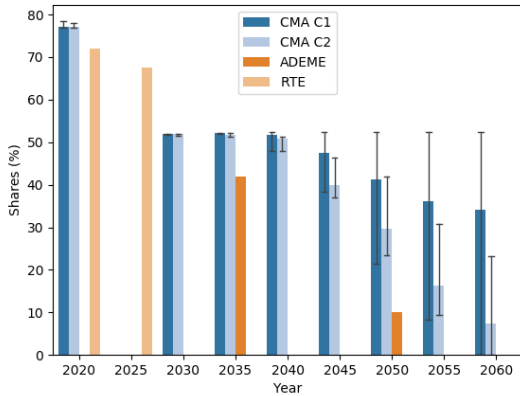

Figure 14. Nuclear shares according to the trajectory

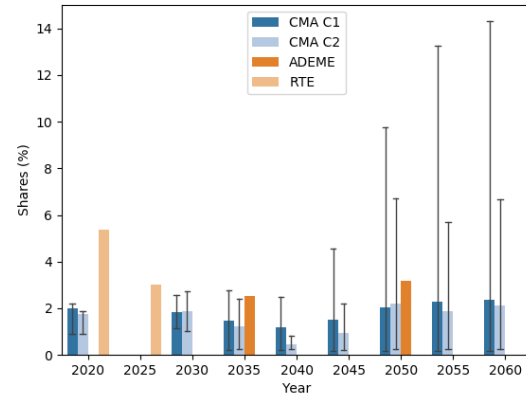

Figure 15. Fossil energy shares according to the trajectory

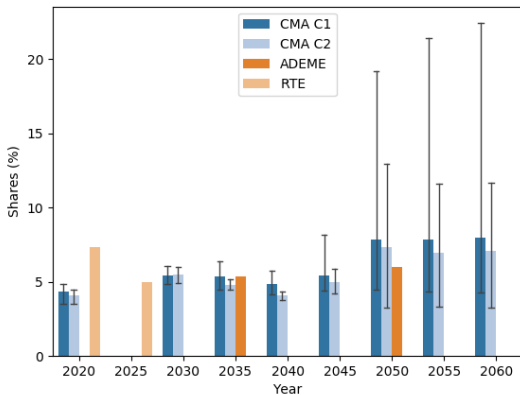

Figure 16. Hydraulic shares according to the trajectory

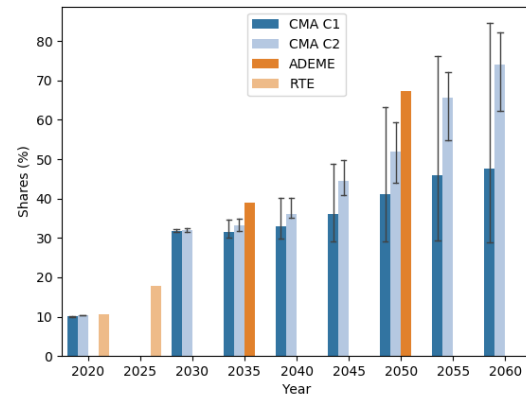

Figure 17. Other renewable energy shares (Wind, PV, waste incineration, biogas, biomass, deep geothermal and ocean energy) according to the trajectory

4.2.2. Environmental impacts

In addition to the greenhouse gases emissions, the study includes a set of environmental impacts such as cumulative energy demand, nuclear waste, biodiversity and health damages. The

environmental impacts associated to the various electricity production processes were taken from ecoinvent 3.4 database. Greenhouse gases emissions associated to the consumption of 1 kWh of electricity depending on the production process are shown in **Figure 18**. (Frossard 2020) highlighted that the ecoinvent data of photovoltaic panels was last updated in 2010. He recommended the creation of a new photovoltaic panel dataset including a reduction of cell thickness, a reduction of the weight of the inverter, a performance improvement and a reduction in electricity consumption in the manufacturing process of silicon cells. Assuming a 30-year lifespan for the photovoltaic panels, for the year 2020 to 2035, the photovoltaic production mix was supposed to be made up of 50% of "old" PV panels (without data update) and 50% of "new" PV panels (with data update). From the year 2035 onwards, only the updated impact was considered.

The environmental impact of imports is based on annual electricity mixes of border countries high-voltage networks. Regarding the ADEME trajectory, the border countries' electricity mixes were derived from the European Network of Transmission System Operators (ENTSOE) forecast (ENTSOE, 2018). With regard to the CMA trajectories, it was assumed that the future mixes of the border countries correspond to the ENTSOE sustainable transition scenario (ENTSOE, 2018).

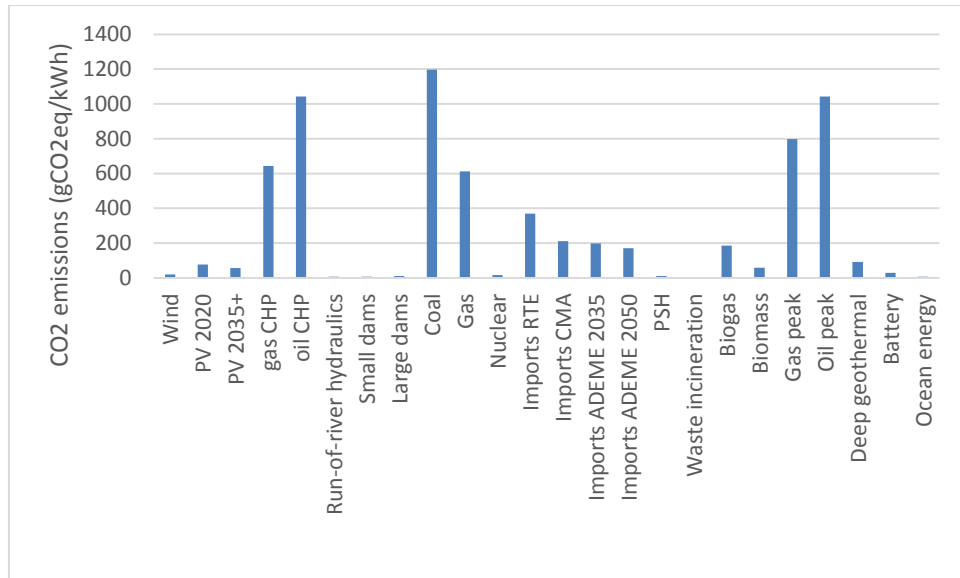

Figure 18. CO₂ emissions associated to the consumption of 1 kWh of electricity depending on the production process (ecoinvent 3.4, and PV 2035 update)

4.3. Results

For each trajectory, two LCA dynamic methods were tested on the buildings panel: attributional respectively consequential i.e. considering average resp. marginal electricity production processes. For each electricity use (space heating, specific electricity, domestic hot water, air conditioning), attributional LCA consists of multiplying the hourly consumption by the corresponding hourly impact which depends on the hourly electricity mix. The results are then divided by the consumption over the lifetime to obtain average impacts per kWh consumed.

One marginal method considers the environmental impacts related to marginal production processes, according to the GHG-P method (cf. section 3). In order to identify the marginal production process, production technologies are ranked according to their merit order (non-dispatchable technologies, hydraulic, nuclear, gas, coal, peak technologies). The marginal level of production is set at 10% of the total hourly production. This method was applied for all trajectories.

A second method was carried out by simulating the electricity mix generation model described in section 3 with and without the additional consumption induced by the building. The mix without the additional consumption is deducted from the mix including it in order to obtain the marginal derivative mix (MD). Therefore, this second marginal method is only applicable to the trajectory using RTE short-term forecast scenario. **Figure 19** to **Figure 23** show average impacts (CO₂ emissions, cumulative energy demand, radioactive waste, health and biodiversity damages) for all buildings, according to the LCA method (attributional, GHG-P and MD), the electricity use (heating, cooling, domestic hot water (DHW), specific electricity) and the photovoltaic production. The values attributed to the photovoltaic production represent the average impacts that can be avoided thanks to 1 kWh of photovoltaic production.

Marginal mixes (GHG-P and MD methods) are mainly composed of coal, gas, nuclear and peak technologies productions which explains the highest values of the different impacts compared to the attributional method. The GHG-P method leads to CO₂ emissions three times lower than the MD method. However, this result strongly depends on the margin of the GHG-P method. The use of a margin between 2 and 5 % for the GHG-P method would reduce the gap between the two marginal methods.

Using electricity for heating induces a peak demand in winter, during which production processes and related environmental impacts may differ from an annual average. Impact variation in terms of electricity use is observed only in the consequential LCA method. This confirms the higher consistency of consequential compared to attributional LCA.

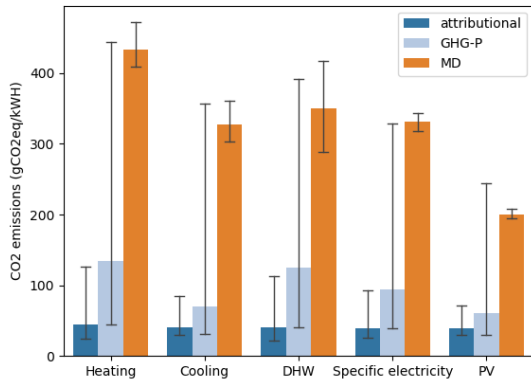

Figure 19. CO2 emissions according to the LCA method and the energy use

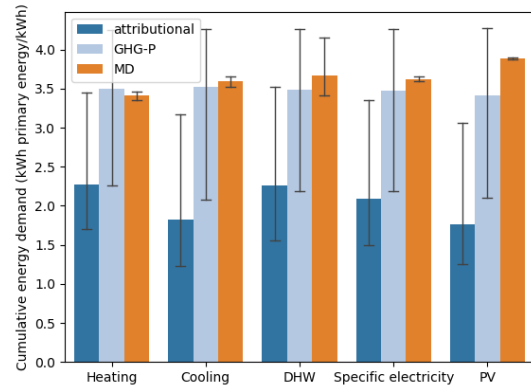

Figure 20. Cumulative energy demand according to the LCA method and the energy use

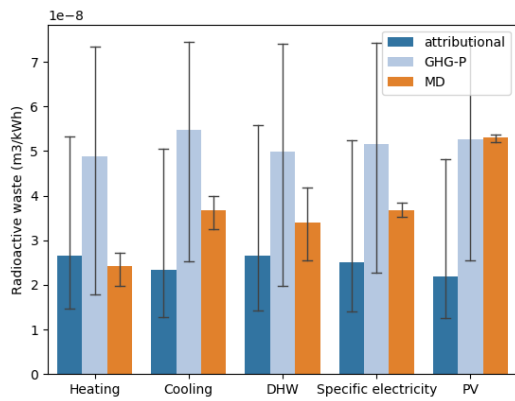

Figure 21. Radioactive waste according to the LCA method and the energy use

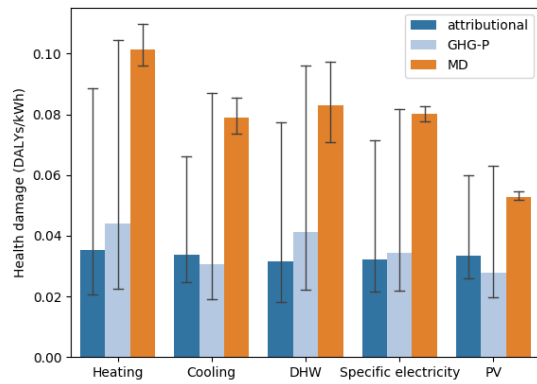

Figure 22. Health damage according to the LCA method and the energy use

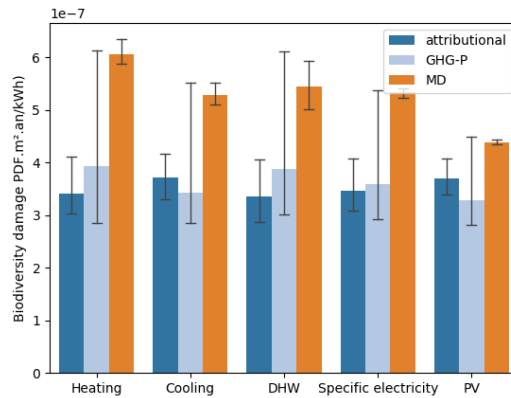

Figure 23. Biodiversity damage according to the LCA method and the energy use

5. DISCUSSION

In general, the environmental impacts vary more depending on the scenarios than in terms of building types, see **Figure 24** corresponding to attributional LCA, and the same trend is obtained using consequential LCA (marginal mix corresponding to the GHG protocole). This may be due to the limited size of the studied sample though extreme cases were included: from a Haussmannian building from the 1880's to a positive energy house and office building (i.e. higher electricity production than consumption). The dispersion of environmental impacts is very large when several prospective scenarios are considered because e.g. the GHG emissions indicator is very sensitive to the share of coal thermal plants in the mix, and there is a large variation of this value according to the scenario. The dispersion is smaller if a lower cost of renewable electricity production is considered (CMA C2 series compared to CMA C1 considering higher costs).

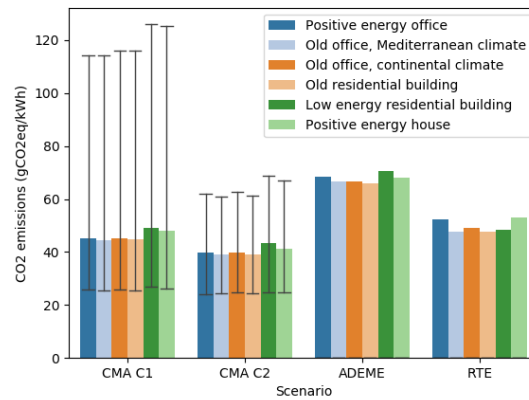

Figure 24. Sensitivity of GHG emissions to the scenario and type of building (attributorial LCA)

Greenhouse gases emissions of the ADEME scenario are higher than the near future scenario and the average of the prospective scenarios obtained by market allocation. This is due to a higher share of imported electricity in this scenario. The imported electricity mix is evaluated according to ENTSOE forecast but this is only one scenario and other possibilities could be considered. Fortunately, in the case of France the share of imported electricity is small in all scenarios (around 5% for the ADEME trajectory and under 1 % for the CMA trajectories) which reduces the related uncertainties.

Consequential LCA requires to account for the consequences induced by the studied system on the background system. In the case of a building constituting an additional consumption (resp. production if PV electricity is exported into the grid), the consequence is a supplementary (resp. reduced) use of a marginal process. One way to identify this process is to model the electricity system with and without the supplementary consumption (resp. production), which we called the marginal derivative. This requires to run the electricity system model in the case of each specific studied building, which is time consuming. The GHG protocol proposes a flat-rate electricity mix corresponding to the 10% highest part of the merit order, which avoids running the

electricity system model. According to (Peuportier et al. 2020), the marginal derivative method corresponds to a mix corresponding to only from 2% to 5% highest merit order processes. The choice of a flat-rate percentage is arbitrary and could be evaluated by comparison with the marginal derivative method over a larger sample of buildings.

Using the attributional LCA method, the same mix is considered for all uses at a certain hour of one year. In fact, if the mix is more carbon-intensive in winter, it is mainly due to heating and not for example to the production of domestic hot water, which varies little over the year. Using consequential LCA, an identical marginal mix is considered for all uses at a given time. However, a seasonal use such as heating induces a greater need for peak capacities than a more constant use such as the production of domestic hot water. These approaches have thus reduced the variation of impacts depending on the uses.

The electricity system model has been calibrated and validated using measurements over past periods. Its reliability over a long-term period during which the capacities may significantly evolve is not guaranteed. Intercomparison with more detailed models would be very useful. A simplified model is needed because running such detailed models would not be compatible with the present building LCA practice due to high computation time and required expertise.

A building is generally designed considering a service life of 100 years or more. The reliability of scenarios over such a long period remains questionable. Resulting LCA indicators can be expressed per year, dividing the total by the length of the simulation period. In such a case, the yearly values correspond to a near future year if the near future scenario is considered, or the first half of the service life if a scenario over 50 years is considered.

It would be interesting to extend the marginal demand for electricity in the case study to the scale of a building stock (several thousands of buildings, different geographical areas)

and to integrate it as marginal demand in the model of prospective. Indeed, the current method does not make it possible to assess the effect of marginal demand on investments in new capacities. Comparison of the two options would allow an assessment of whether this effect is significant or whether it can be overlooked.

In practical application of LCA in the building sector, the methodology could be implemented in various ways according to the goal of the study. The main issue is to deal with the very large variation of impacts when varying the scenario. If the goal is to support a regulation or certification scheme, the precautionary principle should lead to considering values that correspond to e.g. a highest quartile, or a recent past or near future situation. Considering low emissions corresponding to a low carbon scenario could encourage a higher energy consumption in buildings, which in turn would make energy transition potentially more difficult, especially for the electricity system.

If the goal is to support eco-design, performing a sensitivity study or uncertainty calculations could be advised because LCA calculations do not require high computation times. The building LCA tool could perform such a study automatically so that it remains user-friendly.

A method like the GHG protocol may constitute an interesting compromise between very detailed models which are unsuitable for professional practice and simplistic methods leading to significant bias in LCA results. Identifying a marginal mix according to a flat-rate percentage of the merit order reduces the computation time needed for a building LCA compared to a marginal derivative approach. But determining an appropriate flat-rate

percentage according to a climatic context, construction techniques and electricity system is still a research perspective.

6. CONCLUSIONS

A methodology has been developed to link three models addressing: market allocation on a national scale over a long-term period, short-term variation (i.e. seasonal, daily and hourly) of the electricity mix also on a national scale, and building energy simulation at the scale of one building. The first two models provide data regarding the background system of a building LCA, allowing sensitivity studies to be performed according to long term scenarios. This methodology has been applied in a case study including a sample of buildings in the French context, but it could be tested in other countries: aa discussion takes place within the International Energy Agency, Energy in Buildings and Communities program, Annex 72 related to assessing life cycle related environmental impacts caused by buildings. Six buildings have been studied over 100 years considering 50 scenarios.

Results show a high variation of environmental impacts among assessed prospective energy scenarios, for all building types and all end-uses. They also highlight high discrepancies between attributional and consequential LCA. They finally confirm the importance of integrating future energy scenarios in building LCA, considering the long service life of buildings and their important interaction with the energy sector. Methodological recommendations have been made regarding study objectives (e.g. certification scheme or eco-design), identifying the GHG protocol method as a good compromise to be further developed.

7. ACKNOWLEDGMENTS:

This work was performed in the frame of the research project ACVs Energies with the financial support of ADEME.

8. REFERENCES

- ADEME (2019) Trajectoires d'évolution du mix électrique 2020-2060. ADEME
- Amor MB, Gaudreault C, Pineau P-O, Samson R (2014) Implications of integrating electricity supply dynamics into life cycle assessment: A case study of renewable distributed generation. *Renew Energy* 69:410–419. <https://doi.org/10.1016/j.renene.2014.03.063>
- Amorim F, Simoes SG, Siggini G, Assoumou E (2020) Introducing climate variability in energy systems modelling. *Energy* 206:118089. <https://doi.org/10.1016/j.energy.2020.118089>
- Doudard R (2018) Flexibilité et interactions de long terme dans les systèmes multi-énergies : analyse technico-économique des nouvelles filières gazières et électriques en France. These de doctorat, Paris Sciences et Lettres
- European Commission (2016) EU Reference Scenario 2016Energy, transport and GHG emissions Trends to 2050. EUROPEANCOMMISSIONDirectorate-General for Energy, Directorate-General for Climate Action and Directorate-General for Mobility and Transport
- Frossard M (2020) Optimisation robuste multicritère pour l'écoconception de bâtiments zéro-énergie. PSL-Mines ParisTech
- García-Gusano D, Garraín D, Dufour J (2017a) Prospective life cycle assessment of the Spanish electricity production. *Renew Sustain Energy Rev* 75:21–34. <https://doi.org/10.1016/j.rser.2016.10.045>
- García-Gusano D, Garraín D, Dufour J (2017b) Prospective life cycle assessment of the Spanish electricity production. *Renew Sustain Energy Rev* 75:21–34. <https://doi.org/10.1016/j.rser.2016.10.045>
- GHG Protocol (2007) Guidelines for Quantifying GHG Reductions from Grid-Connected Electricity Projects
- GRTgaz, GrDF, SPEGNN, TIGF (2017) Bilan prévisionnel pluriannuel gaz 2017
- Herfray G, Peuportier B (2012) Evaluation of electricity related impacts using dynamic a LCA model. Nantes, juillet 2012, p 9
- IEA (2019) Perspectives for the Clean Energy Transition – Analysis
- Kassara G, Verrier GP, Chammas M, Fournié L (2019) Trajectoires d'évolution du mix électrique 2020-2060 -analyses complémentaires. ADEME, Artelys
- Khan I, Jack MW, Stephenson J (2018) Analysis of greenhouse gas emissions in electricity systems using time-varying carbon intensity. *J Clean Prod* 184:1091–1101. <https://doi.org/10.1016/j.jclepro.2018.02.309>

- Kiss B, Kácsor E, Szalay Z (2020) Environmental assessment of future electricity mix – Linking an hourly economic model with LCA. *J Clean Prod* 264:121536. <https://doi.org/10.1016/j.jclepro.2020.121536>
- Loulou R, Antti, Lehtilä, Amit, Kanudia, et al (2016) ETSAP-TIMES PART II: REFERENCE MANUAL. 384
- Lund H, Mathiesen B, Christensen P, Schmidt J (2010) Energy system analysis of marginal electricity supply in consequential LCA. *Int J Life Cycle Assess* 15:260–271. <https://doi.org/10.1007/s11367-010-0164-7>
- Messagie M, Mertens J, Oliveira L, et al (2014) The hourly life cycle carbon footprint of electricity generation in Belgium, bringing a temporal resolution in life cycle assessment. *Appl Energy* 134:469–476. <https://doi.org/10.1016/j.apenergy.2014.08.071>
- Ortega M, Río P del, Ruiz P, et al (2020) Analysing the influence of trade, technology learning and policy on the employment prospects of wind and solar energy deployment: The EU case. *Renew Sustain Energy Rev* 122:109657. <https://doi.org/10.1016/j.rser.2019.109657>
- Pehnt M (2006) Dynamic life cycle assessment (LCA) of renewable energy technologies. *Renew Energy* 31:55–71. <https://doi.org/10.1016/j.renene.2005.03.002>
- Pereira L, Posen D (2020) Lifecycle greenhouse gas emissions from electricity in the province of Ontario at different temporal resolutions. *J Clean Prod* 270:122514. <https://doi.org/10.1016/j.jclepro.2020.122514>
- Peuportier B, Leurent F, Roger-Estrade J, Éco-conception des ensembles bâtis et des infrastructures (2018) Éco-conception des ensembles bâtis et des infrastructures. Tome 2. Mines ParisTech : PSL, Paris
- Roux C, Schalbart P, Assoumou E, Peuportier B (2016a) Integrating climate change and energy mix scenarios in LCA of buildings and districts. *Appl Energy* 184:619–629. <https://doi.org/10.1016/j.apenergy.2016.10.043>
- Roux C, Schalbart P, Peuportier B (2016b) Development of an electricity system model allowing dynamic and marginal approaches in LCA—tested in the French context of space heating in buildings. *Int J Life Cycle Assess*. <https://doi.org/10.1007/s11367-016-1229-z>
- RTE éco2mix. <https://www.rte-france.com/eco2mix>. Accessed 9 Nov 2020
- RTE (2017a) Bilan prévisionnel de l'équilibre offre-demande d'électricité en France - édition 2017
- RTE (2017b) Réseaux électriques intelligents Valeur économique, environnementale et déploiement d'ensemble. RTE
- Soimakallio S, Kiviluoma J, Saikku L (2011) The complexity and challenges of determining GHG (greenhouse gas) emissions from grid electricity consumption and conservation in

- LCA (life cycle assessment) – A methodological review. *Energy* 36:6705–6713.
<https://doi.org/10.1016/j.energy.2011.10.028>
- Tokimatsu K, Endo E, Murata A, et al (2016) An Integrated Assessment by Models for Energy Systems Analysis and Life-Cycle Assessment with a Case Study of Advanced Fossil-Fired Power Plants in China. *Environ Model Assess* 21:291–305.
<https://doi.org/10.1007/s10666-015-9479-x>
- Victoria M, Gallego-Castillo C (2019) Hourly-resolution analysis of electricity decarbonization in Spain (2017–2030). *Appl Energy* 233–234:674–690.
<https://doi.org/10.1016/j.apenergy.2018.10.055>
- Vuarnoz D, Jusselme T (2018) Temporal variations in the primary energy use and greenhouse gas emissions of electricity provided by the Swiss grid. *Energy* 161:573–582.
<https://doi.org/10.1016/j.energy.2018.07.087>