



HAL
open science

Étude par PIV du sillage induit par un disque poreux

Fethi Aloui, Mouldi Kardous, Rym Chaker, Sassi Ben Nasrallah

► **To cite this version:**

Fethi Aloui, Mouldi Kardous, Rym Chaker, Sassi Ben Nasrallah. Étude par PIV du sillage induit par un disque poreux. CFM 2013 - 21ème Congrès Français de Mécanique, Aug 2013, Bordeaux, France. hal-03440606

HAL Id: hal-03440606

<https://hal.science/hal-03440606>

Submitted on 22 Nov 2021

HAL is a multi-disciplinary open access archive for the deposit and dissemination of scientific research documents, whether they are published or not. The documents may come from teaching and research institutions in France or abroad, or from public or private research centers.

L'archive ouverte pluridisciplinaire **HAL**, est destinée au dépôt et à la diffusion de documents scientifiques de niveau recherche, publiés ou non, émanant des établissements d'enseignement et de recherche français ou étrangers, des laboratoires publics ou privés.

Study of the wake induced by a porous disc

F. ALOUI^a, M. KARDOUS^a, R. CHEKER^a, S. BEN NASRALLAH^b

a. *Laboratoire de Maîtrise de l'Énergie Éolienne et de Valorisation Énergétique des Déchets, Centre de Recherches et des Technologies de l'Énergie de Borj Cedria, Tunis, Tunisie.*

b. *Laboratoire d'Étude des Systèmes Thermiques et Énergétiques, Ecole Nationale d'Ingénieurs de Monastir, Tunisie.*

Résumé :

Cet article présente une étude de la structure du champ de vitesse du vent dans la région de sillage de l'éolienne. Les éoliennes sont modélisées en utilisant le concept de disque poreux qui peut reproduire le déficit de vitesse du vent et la turbulence de cisaillement produite dans l'écoulement passant par l'éolienne. La Vélocimétrie par Image de particule (PIV) a été utilisée pour mesurer le champ de vitesse. Les mesures de vitesse en aval de disques a permis de calculer les coefficients de poussée et de puissance, en utilisant la théorie de l'écoulement axiale. La validation du concept a d'abord été effectuée. La Décomposition Orthogonale Propre (POD) a été appliquée afin d'en extraire les structures cohérentes dominantes du champ de vitesse mesuré. En effet, la POD permettra l'extraction des structures cohérentes les plus énergétiques responsables de l'organisation de l'écoulement.

Abstract :

This paper presents a study of the structure of wind velocity field in the wake region behind of wind turbine. Wind turbines are modeled using the concept of porous disc which can reproduce the wind velocity deficit and the shear-produced turbulence in the flow going through the turbine. Particle Image Velocimetry (PIV) system was used to acquire the original complex turbulent flow field. Velocity measurements downstream of the discs enabled to compute the thrust and power coefficients, using the global momentum theory. The validation of the concept was first performed. Proper Orthogonal Decomposition (POD) analysis was applied in order to extract the main structure of the overall physical phenomenon from the measured wind velocity field.

Mots clefs : Wind energy ; wake ; porous disc

1 Introduction

In a world increasingly conscious of the degrading state of its environment and with the surge of the oil prices, renewable energies have found a choice place in the energy supply strategies of a great number of countries. Exceptionally these last decades the production of the electricity from the wind energy recorded a considerable increase in the world. It is for this reason that more and more wind turbines have been installed in large wind farms. The grouping of wind turbines in such a farm introduces two major issues : a wind turbine operating in the wake of another turbine has a reduced power production and shortens the lifetime of the rotors. So the investigation of the wake development downstream wind turbines is required for the design of wind farms. The studied wind turbine is then either a small model of the original wind turbine, or a porous obstacle having the same properties of drag as the original wind turbine. In some cases discs have been used to simulate the wakes of wind turbines in wind tunnels ([1],[2]). The authors specify that matching the tip speed ratio of a wind turbine with a smaller model would be to change the flow characteristics of the flow field due to the high rotational speed. Therefore these measurements focus on the drag coefficient. The same pressure drop as through a rotor is created by means of porous discs, which also avoid a large separation region. Several drag coefficients have been tested by changing the disc porosity ([3],[4],[5]). The aim of this work is to

study the aerodynamic behavior of porous disc in order to characterize the mixing layer that forms in the wake of the porous disc. PIV was used to focus on the spatial development of the wake, up to 4 rotor diameters downstream. Special post-processing has been developed in order to extract the main structure of the overall physical phenomenon from the measured wind velocity field.

2 Experimental device and metrology

Wind tunnel experiments performed in the wind tunnel of the Energy Research and Technologies Center. The dimensions of the test section were $800 \times 1000 \times 4000 \text{ mm}^3$ (Figure 1). The maximum free stream velocity achievable is 30 m/s and the turbulence intensity is equal to 0.1%. The free stream velocity was monitored via a Pitot tube positioned 10 D upstream from the disc, and it was proven to be constant during the test within a 1% uncertainty. It is noted that turbulence level in the upstream flow is not a realistic level compared to real wind turbine operating conditions. The air temperature variations were considered negligible for the current tests.

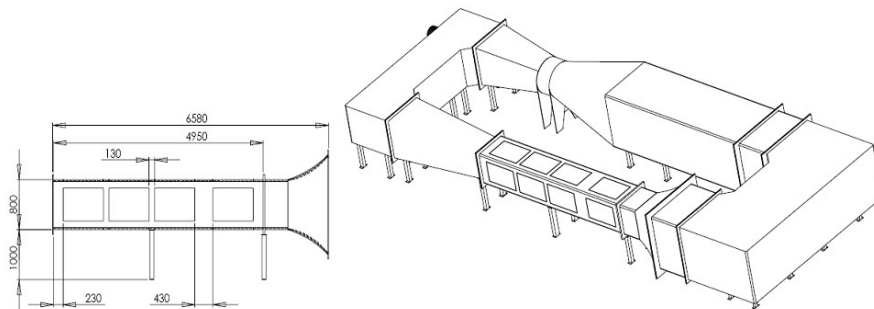

FIGURE 1 – CRTE n wind tunnel.

The modelled wind turbine is of type Enercon E70. In normal conditions of functioning, for a velocity of 10 m/s, this wind turbine possesses, according to its data sheet, a power coefficient $C_P = 0.5$ and an induction factor $a=0.19$. The wind turbine was modelled with a 100 mm diameter porous disc (Figure 2). The disc was attached to the floor with a vertical cylinder of diameter 0.05 D, which is in agreement with standard wind turbine mast diameters. The disc is placed in the middle section of the test section. The average velocity in the plane of the disc, in the absence of it, is about 10 m/s. The porosity used in this study is about 55% as determined by the mesh size and wire diameter.

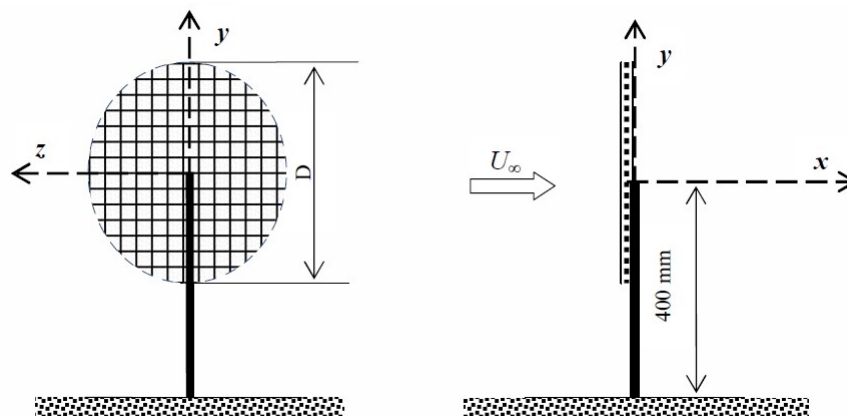

FIGURE 2 – Experimental set-up and coordinate system.

2.1 PIV system

The PIV system was a commercial 2D PIV system from Dantec dynamics (Figure 3). A double pulsed Nd-YAG laser has been used. This delivers an energy of $2 \times 65 \text{ mJ}$ that illuminate the smoke used as flow

seeding with a 1 mm thick sheet. The flow is seeded with micrometersized droplets generated by a smog generator. The size of the particles is about $1\mu m$. A flow Sens camera has been used with a resolution of 1600×1200 pixels, recording double fullframe particle images. The system, both camera and laser, has operated at frequency of 10 Hz. The size of the measurement area has been $210 \times 158 mm^2$. Studio Dynamics software, from Dantec Dynamics was used to compute the instantaneous velocity field. The 1600×1200 pixels images were processed using adaptive correlation. The interrogation window is fixed to 32×32 pixels, providing a spatial resolution of approximately $3.3 \times 3.3 mm^2$. The overlap ratio between adjacent interrogation windows is 50%, providing instantaneous velocity fields with 99×74 vectors. Subsequently, mean velocity fields were calculated as the average of 500 instantaneous velocity fields.



FIGURE 3 – PIV setup.

3 Experimental results

3.1 Mean velocity field

For reasons of validation, the first step of this work consisted in calculating the induction factor and the coefficients of power and thrust respectively according to the expressions $a = \frac{1}{2}(1 - \frac{U_w}{U_\infty})$, $C_P = 4a(1-a)^2$ and $C_T = 4a(1-a)$. In these expressions U_w is the minimal velocity measured downstream to the porous disc and U_∞ is the free flow velocity measured far upstream to the porous disc. Obtained values were compared with those who correspond to the point of functioning of the original wind turbine. From the measures of the velocity field, the minimal value was found at a distance equal to 41.7 cm downstream to the disc or in $x/D = 4.17$, its value is equal to 6.22 m/s (Figure 4). In these conditions, the coefficients a , C_P and C_T equivalent to 0.189, 0.497 and 0.61 respectively. They are very close to values of the original coefficients of the wind turbine which are respectively 0.19, 0.5 and 0.62. With underestimates of the variable original values from 0.5 to 16% we can consider reasonably that the model is valid and can be used for the rest of the work. The figure 5 represents the average velocity field of the flow downstream the disc. It shows that the disc has create a velocity deficit between the upstream and downstream of the flow. Furthermore, the disc generates an extension of the streamtube and the formation of a mixture layer. By the superimposing of seven profiles of the mean velocity longitudinal the state of similarity of the mixture layer is verified (Figure 6-a). In these conditions the thickness of vorticity which is a characteristic of the mixture layer is given by this expression : $(\delta_w = \frac{U_\infty - U_w}{\max(\frac{dU}{dy})})$. The figure 6-b shows the variation of this characteristic from $x/D = 2$. Furthermore, this figure shows that the evolution of the thickness of vorticity is linear with a growth rate of $d\delta_w/dx = 0.105$. The found value is comparable to the value observed for a classic mixture layer [5]. Indeed, these authors found a growth rate equal to $d\delta_w/dx = 0.17$.

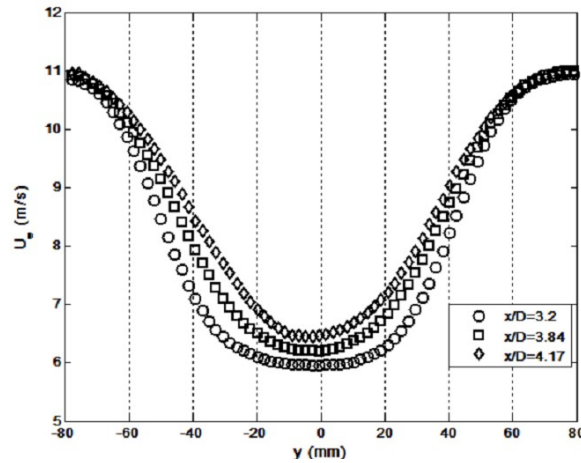

FIGURE 4 – Streamwise velocity downstream of a porous disc, $x/D = 3.2$, $x/D = 3.84$ and $x/D = 4.17$.

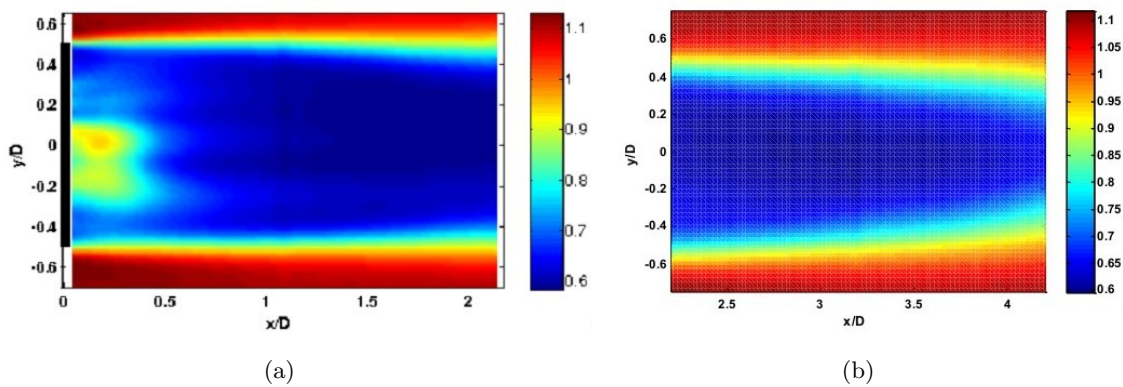

FIGURE 5 – Iso-contours of the normalised longitudinal mean component. (a) Near field. (b) Far field.

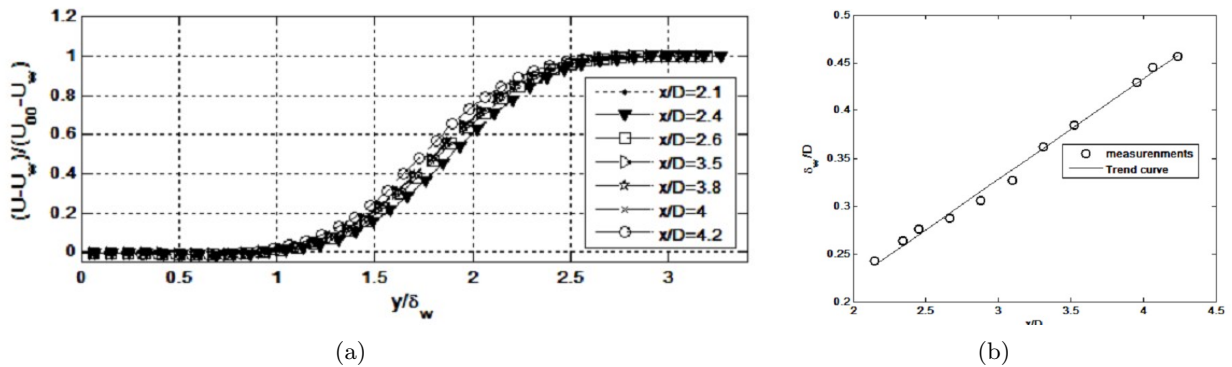

FIGURE 6 – Shear layer. (a) Profiles $(U - U_w)/(U_\infty - U_w)$ at different positions. (b) Variation of the thickness of the shear layer.

3.2 Instantaneous velocity field

In the wake zone the general flow is characterized by a vortex exhaust that similar to the flow around a disc (Figure 7). These vortex that take birth at the periphery of the disc, appear in the form of vortex rings giving rise to a very unstable flow which could increase the aerodynamic loads. In these conditions, the disc will be exposed to a strong vibrations and in the case of a wind turbine, that means a reduction in performances and durability. The figure 7 shows the shifts in the trajectory of the wake compared to the axis of symmetry of the disc. This flapping motion of the shear layer

indicates unsteadiness which is associated to the passage of coherent structures in the shear layer. Thus, the characterization of the coherent structures and the analysis of unsteady flow go through the isolation of the vortices created in the sheared zone of the rest of the flow. To achieve this, we developed a post-processing of PIV data based on proper orthogonal decomposition method.

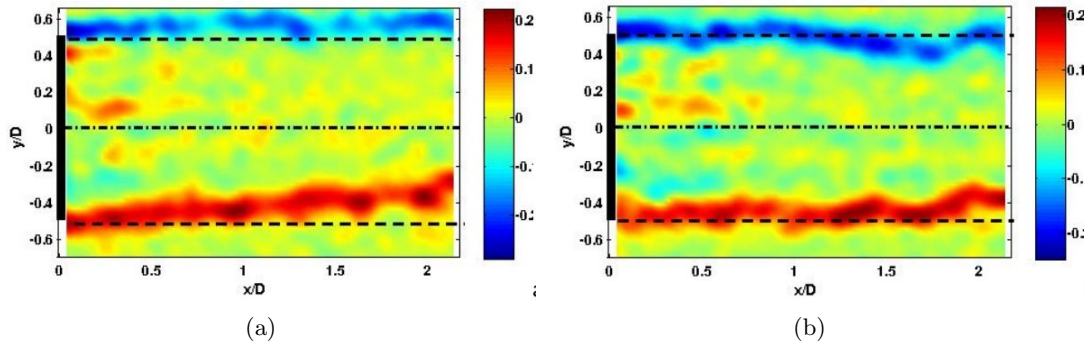

FIGURE 7 – Iso-contours of vorticity. (a) Wake directed upwardly. (b) Wake directed downwardly.

4 POD analysis of wind velocity field in the wake region

4.1 Outline of POD analysis

POD analysis was applied to the measured data in order to extract dominant structure from the overall phenomenon observed in the wind velocity field. In the present work, the snapshot POD technique, first proposed by Sirovich[6], is performed on fluctuating velocity fields of wind flow in the wake region. The formulation of POD analysis for wind velocity $V(x,y,t)$ is generally expressed in a matrix format as :

$$[C](\Phi_m) = \lambda_m(\Phi_m) \quad (1)$$

where C is the correlation matrix of the fluctuating wind velocity field ($M \times M$), (Φ_m) is the eigenvector and λ_m is the eigenvalue of the m th mode ($m = 1, 2, \dots, M$). The result of the first mode obtained by Eq. (1) can provide the most effective information on the fluctuation of the given wind velocity field. Due to the orthogonality of the modes, original wind velocity $V(x,y,t)$ can be expressed as follows :

$$V(x,y,t) = \sum_{m=1}^M a_m(t)\Phi_m(x,y) \quad (2)$$

where Φ_m is the eigenvector in the m th mode, and the correspond time-dependent principal coordinate $a_m(t)$ is as follows :

$$a_m(t) = \frac{\int \int V(x,y,t)\Phi_m dx dy}{\int \int \Phi_m^2(x,y) dx dy} \quad (3)$$

4.2 Extraction of dominant modes

Wake region to be considered for the analysis is $2D$ in length by $1.4D$ in width and this region includes 74×99 measured points. Here, each instantaneous PIV measurement is considered to be a snapshot of the flow. An analysis is then performed on typically 500 snapshots taken in the same plane. The mean velocity field can be considered the zeroth mode of the POD. The spatial modes of the wind flow show that a two conventional mixing layers are shown in Figure 8. The regions of main activities are centered about $y/D = 0.5$ and $y/D = -0.5$ (the edge of the disc). The following mode 8 (Figure 8-c) and mode 9 (Figure 8-d) allow the visualization of coherent structures according to their energy. This modes show a certain form of organization of these structures. It should be noted that the distances between maxima and minima are not constant because the measurement is just behind the disc, where there are large variations in the mean flow. Thus, this analysis shows the formation of vortex structures

in the shear zone. These structures are the main source of noise and aerodynamic loads and possibly meandering phenomenon. This beating demonstrates that the flow is quasi-periodic, with significant variations in amplitude occurring momentarily. This quasi-periodic nature is justified by the fact that the flow is transitional in the shear layer and there are small turbulent eddies absorbing some of the flow energy.

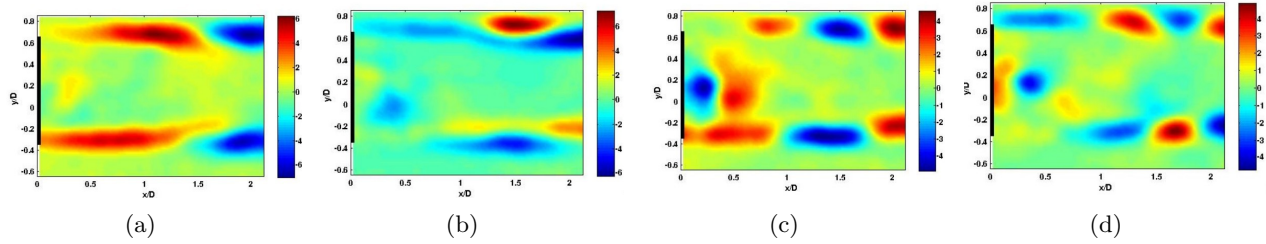

FIGURE 8 – Eigenvectors. (a) Mod4. (b) Mod5. (c) Mod8. (d) Mod9.

5 Conclusion

This paper presents a convenient approach for the modeling of wind turbines by porous disc. The PIV method is carried out to measure the velocity field in the wake zone. Two approaches were used, an approach steady and unsteady approach. The study of a stationary viewpoint neglects a certain number of phenomena characterizing the wake. Indeed, the average field shows a loss of energy of the flow immediately downstream of the disc. Nevertheless, the unsteady view offering a new perspective on the the form and to the dynamics of the wake. The unsteady velocity fields show a kind of flapping, resulting of motion wake. The POD analysis reveals the formation of alternating vortices. These structures are the main source of noise and aerodynamic loads. As perspective to this work is the development of a method that combines the temporal correlation and FFT analysis to estimate the frequency of vortex shedding in the flow from PIV experimental data.

Références

- [1] Mechali. M , Barthelmie. R, Frandsen, S. Frandsen, and Rethore. P.E 2006 Wake effects at horns rev and their influence in wind energy production. *Proceedings, 27 Feb - 2 March, Athens, Greece.*
- [2] Espana.G, Aubrun.S, Loyer. S, Devinant.P 2011 Spatial study of the wake meandering using modelled wind turbines in a wind tunnel. *Wind Energy 14, 7 923-937 [hal-00654726 - version 1].*
- [3] VanLuvanee.D.R 2006 Investigation of observed and modelled wake effects at Horns Rev using WindPro. *Technical University of Denmark, MEK Department, Fluid Mechanics Section. MEK-FM-EP.*
- [4] Aubrun.S, Devinant.P, Espana.G 2007 Physical modelling of the far wake from wind turbines. Application to wind turbine interactions. *Proc. of EWEC 2007, 7-10 May 2007, Milan, Italy.*
- [5] Trujillo, Kühn.M 2009 Adaptation of a Lagrangian dispersion model for wind turbine wake meandering simulation. *Proc. of EWEC ,16-19 Mars, Marseille, France.*
- [6] Ho, C. M., and Huang, L. S. 1982 Subharmonics and vortex merging in mixing layers. *Journal of Fluid Mechanics 119, 443-473.*
- [7] Cordier.L, Bergmann.M 2002 Proper orthogonal decomposition : an overview, in : Lecture Series 2002-04 on Post-Processing of Experimental and Numerical Data. *Von Kármán Institute of Fluid Dynamics*