



HAL
open science

Asymptotic Eigenvalue Distribution of Block Toeplitz Matrices and Application to Blind SIMO Channel Identification

Jean-Pierre Delmas, Houcem Gazzah, Phillip A Regalia

► **To cite this version:**

Jean-Pierre Delmas, Houcem Gazzah, Phillip A Regalia. Asymptotic Eigenvalue Distribution of Block Toeplitz Matrices and Application to Blind SIMO Channel Identification. IEEE Transactions on Information Theory, 2001. ⟨hal-03435709⟩

HAL Id: hal-03435709

<https://hal.science/hal-03435709v1>

Submitted on 18 Nov 2021

HAL is a multi-disciplinary open access archive for the deposit and dissemination of scientific research documents, whether they are published or not. The documents may come from teaching and research institutions in France or abroad, or from public or private research centers.

L'archive ouverte pluridisciplinaire **HAL**, est destinée au dépôt et à la diffusion de documents scientifiques de niveau recherche, publiés ou non, émanant des établissements d'enseignement et de recherche français ou étrangers, des laboratoires publics ou privés.



HAL Authorization

Asymptotic Eigenvalue Distribution of Block Toeplitz Matrices and Application to Blind SIMO Channel Identification

Houcem Gazzah, Phillip A. Regalia and Jean-Pierre Delmas

Abstract—Szegő's theorem states that the asymptotic behavior of the eigenvalues of a Hermitian Toeplitz matrix is linked to the Fourier transform of its entries. This result was later extended to block Toeplitz matrices, i.e., covariance matrices of multi-variate stationary processes. The present work gives a new proof of Szegő's theorem applied to block Toeplitz matrices. We focus on a particular class of Toeplitz matrices, those corresponding to covariance matrices of Single Input Multiple Output channels. They satisfy some factorization properties that lead to a simpler form of Szegő's theorem and allow one to deduce results on the asymptotic behavior of the lowest nonzero eigenvalue for which an upper bound is developed and expressed in terms of the subchannels frequency responses. This bound is interpreted in the context of blind channel identification using second order algorithms, and more particularly the case of bandlimited channels.

Keywords—Asymptotic eigenvalue distribution, bandlimited channels, blind identification, block Toeplitz matrices, multivariate processes, second order statistics algorithms.

I. INTRODUCTION

IN a celebrated result appearing in [1], Szegő states that the eigenvalues of a sequence of Hermitian Toeplitz matrices are asymptotically distributed like the samples of the Fourier transform of its entries. The lowest/highest eigenvalue are decreasing/increasing and converge to the minimum/maximum of this Fourier transform. The application of this result to covariance matrices of scalar stationary¹ processes is straightforward. Several extensions have since been made (see [2]). The most important extends Szegő's theorem to block Toeplitz matrices with non-Toeplitz blocks where the number of blocks tends to infinity [3], [4]. However, the proof made therein relies on sophisticated mathematics. In this paper, we suggest a simpler proof than that in [3], [4] of the extension of the Szegő theorem to block Toeplitz structured matrices. We use the asymptotic equivalence of matrix sequences and more particularly the result established by Gray in [5] on asymptotic equivalence of Toeplitz matrix sequences and circulant matrix sequences. We focus then on a special class of block Toeplitz matrices, frequently encountered in signal processing, to give a simpler form of the Szegő theorem and deduce results about the lowest nonzero eigenvalue, which expresses the conditioning with respect to inversion

Authors are with Département Signal et Image, Institut National des Télécommunications (INT), 9 rue Charles Fourier, 91011 Evry Cedex, France. Phone: (33) 1 60 76 45 44. Fax: (33) 1 60 76 44 33. E-mail: gazzah@sim.int-evry.fr, Phillip.Regalia@int-evry.fr, Jean-Pierre.Delmas@int-evry.fr .

¹Stationary processes denote throughout the paper second-order stationary processes.

of such matrices.

We target in particular second-order statistics based blind identification algorithms of single input multiple output channels (SIMO) where channel output covariance matrices are manipulated in such a way that the performance of the algorithms depends heavily on how well-conditioned the matrix is [6], [7]. Therefore, the interest in eigenvalues (and more particularly the lowest nonzero eigenvalue) of block Toeplitz matrices is highly justified and constitutes the subject of this paper.

This paper is organized as follows. In Section II, results on asymptotic equivalence of Toeplitz matrix sequences as well as Szegő's theorem are reviewed for convenience of the reader and in order to fix notations. In Section III, we propose a new proof of Szegő's theorem extended to block Toeplitz matrices with non-Toeplitz blocks where the number of blocks tends to infinity. We address then a specific class of block Toeplitz matrices, that of SIMO channel covariance matrices. In Section IV, implications for blind channel identification are discussed and the case of bandlimited channels is particularly addressed.

II. NOTATIONS AND PREVIOUS RESULTS

Let $\{t_k\}_{k=\dots,-1,0,1,\dots}$ be an absolutely summable infinite complex sequence (i.e., $\sum_k |t_k| < \infty$) so that the associated 2π -periodic Fourier transform $t(w) \triangleq \sum_k t_k e^{-ikw}$ is well defined. We define the infinite matrix sequence $\{\mathbf{T}_n(t)\}_{n \geq 1}$ where $\mathbf{T}_n(t)$ is the $n \times n$ Toeplitz matrix given by

$$\mathbf{T}_n(t) \triangleq \begin{bmatrix} t_0 & t_{-1} & \cdots & t_{-(n-1)} \\ t_1 & \ddots & \ddots & t_{-(n-2)} \\ \vdots & \ddots & & \vdots \\ t_{n-1} & t_{n-2} & \cdots & t_0 \end{bmatrix}.$$

Consider a sequence of $n \times n$ matrices \mathbf{A}_n . To study the asymptotic equivalence of sequences of such matrices, two norms have been introduced [5]. The strong norm $\|\mathbf{A}_n\|$ and the weak norm $|\mathbf{A}_n|$ are defined, respectively, as the spectral norm $\|\mathbf{A}_n\|^2 \triangleq \max_{\|\mathbf{x}\|=1} \mathbf{x}^H \mathbf{A}_n^H \mathbf{A}_n \mathbf{x}$ and as the normalized Frobenius norm $|\mathbf{A}_n|^2 \triangleq \frac{1}{n} \sum_{i=1}^n \sum_{j=1}^n |a_{i,j}|^2$. $\sigma_k(\mathbf{A})$ (resp., $\lambda_k(\mathbf{A})$) refers to the k -th largest singular value (resp. eigenvalue) of the matrix (resp. the square matrix) \mathbf{A} . $\mathbf{K}_{r,s}$ represents the vec-permutation matrix [8] such that $\text{Vec}(\mathbf{A}) = \mathbf{K}_{r,s} \text{Vec}(\mathbf{A}^T)$ for all $r \times s$ matrices \mathbf{A} . It satisfies $\mathbf{K}_{r,s} = \mathbf{K}_{s,r}^{-1} = \mathbf{K}_{s,r}^T$.

The following definitions and results, necessary for Section III, are recalled:

Definition 1: Asymptotic equivalence [5]

Two matrix sequences $\{\mathbf{A}_n\}$ and $\{\mathbf{B}_n\}$, $n = 1, 2, \dots$ are said to be asymptotically equivalent and noted $\{\mathbf{A}_n\} \sim \{\mathbf{B}_n\}$ if

$$\exists M < \infty \text{ such that } \forall n, \|\mathbf{A}_n\| \leq M \text{ and } \|\mathbf{B}_n\| \leq M \quad (1)$$

$$\lim_{n \rightarrow \infty} \|\mathbf{A}_n - \mathbf{B}_n\| = 0 \quad (2)$$

Lemma 1: [5]

If $\{\mathbf{A}_n\} \sim \{\mathbf{B}_n\}$ and if $\lim_{n \rightarrow \infty} \frac{1}{n} \sum_{k=1}^n \lambda_k^s(\mathbf{A}_n)$ exists and is finite for any positive integer s , then $\lim_{n \rightarrow \infty} \frac{1}{n} \sum_{k=1}^n \lambda_k^s(\mathbf{A}_n) = \lim_{n \rightarrow \infty} \frac{1}{n} \sum_{k=1}^n \lambda_k^s(\mathbf{B}_n)$.

Lemma 2: [5]

For all absolutely summable sequences $\{t_k\}_{k=\dots, -1, 0, 1, \dots}$, there exists a sequence of circulant matrices $\{\mathbf{C}_n(t)\}$ asymptotically equivalent to $\{\mathbf{T}_n(t)\}$ and given by $\mathbf{C}_n(t) = \mathbf{U}_n^H \mathbf{D}_n(t) \mathbf{U}_n$ where $\mathbf{D}_n(t)$ is a diagonal matrix with its k -th entry given by $(\mathbf{D}_n(t))_{k,k} = t \left(\frac{2\pi(k-1)}{n} \right)$ and \mathbf{U}_n is the unitary DFT matrix $(\mathbf{U}_n)_{k,l} = \frac{1}{\sqrt{n}} e^{-i2\pi \frac{(k-1)(l-1)}{n}}$.

We will make use of the fact that the eigenvectors of $\mathbf{C}_n(t)$ are independent of the sequence $\{t_k\}$ and that its eigenvalues are equally spaced samples of the Fourier transform $t(w)$. We finally recall the Szegő result for a Toeplitz matrix that we will extend in Section III to the block Toeplitz matrices:

Theorem 1: Szegő's theorem [1]

For all absolutely summable sequences $\{t_k\}_{k=\dots, -1, 0, 1, \dots}$, if $\mathbf{T}_n(t)$ is Hermitian, then for all functions F continuous on $[\min_w t(w), \max_w t(w)]$

$$\lim_{n \rightarrow \infty} \frac{1}{n} \sum_{k=1}^n F(\lambda_k(\mathbf{T}_n(t))) = \frac{1}{2\pi} \int_{-\pi}^{\pi} F(t(w)) dw.$$

Theorem 2: [1], [9]

For all absolutely summable sequences $\{t_k\}_{k=\dots, -1, 0, 1, \dots}$, if $\mathbf{T}_n(t)$ is Hermitian, then, for any l , the lowest (resp. largest) l eigenvalues of $\mathbf{T}_n(t)$ are decreasing (resp. increasing) with n and converge to $\min_w t(w)$ (resp. $\max_w t(w)$).

III. BLOCK TOEPLITZ MATRICES

A. Definitions

To extend the preceding results to block Toeplitz matrices, we define the block Toeplitz matrix

$$\mathcal{T}_n'(\{t^{u,v}\}) = \begin{bmatrix} \mathbf{T}_0 & \mathbf{T}_{-1} & \cdots & \mathbf{T}_{-(n-1)} \\ \mathbf{T}_1 & \ddots & \ddots & \mathbf{T}_{-(n-2)} \\ \vdots & \ddots & \ddots & \vdots \\ \mathbf{T}_{n-1} & \mathbf{T}_{n-2} & \cdots & \mathbf{T}_0 \end{bmatrix} \quad (3)$$

where $(\mathbf{T}_k)_{k=-(n-1), \dots, n-1}$ are $c \times c$ matrices (not necessarily Toeplitz) of entries $t_k^{u,v} \triangleq (\mathbf{T}_k)_{u,v}$, $u, v = 1, \dots, c$. We consider the associated matrix

$$\mathcal{T}_n(\{t^{u,v}\}) \triangleq \begin{bmatrix} \mathbf{T}_n(t^{1,1}) & \mathbf{T}_n(t^{1,2}) & \cdots & \mathbf{T}_n(t^{1,c}) \\ \mathbf{T}_n(t^{2,1}) & \mathbf{T}_n(t^{2,2}) & \cdots & \mathbf{T}_n(t^{2,c}) \\ \vdots & \vdots & \ddots & \vdots \\ \mathbf{T}_n(t^{c,1}) & \mathbf{T}_n(t^{c,2}) & \cdots & \mathbf{T}_n(t^{c,c}) \end{bmatrix} \quad (4)$$

where $\mathbf{T}_n(t^{u,v})$, $u, v = 1, \dots, c$ are the $n \times n$ the Toeplitz

$$\text{matrices } \begin{bmatrix} t_0^{u,v} & t_{-1}^{u,v} & \cdots & t_{-(n-1)}^{u,v} \\ t_1^{u,v} & \ddots & \ddots & t_{-(n-2)}^{u,v} \\ \vdots & \ddots & \ddots & \vdots \\ t_{n-1}^{u,v} & t_{n-2}^{u,v} & \cdots & t_0^{u,v} \end{bmatrix}. \quad \text{We suppose}$$

$\{t_k^{u,v}\}$, $u, v = 1, \dots, c$ to be a finite set of absolutely summable infinite sequences². So, the Fourier transform $t^{u,v}(w) \triangleq \sum_k t_k^{u,v} e^{-ikw}$ can be associated with each sequence. Using the vec-permutation matrix $\mathbf{K}_{r,s}$ [8], we have $\mathcal{T}_n'(\{t^{u,v}\}) = \mathbf{K}_{n,c} \mathcal{T}_n(\{t^{u,v}\}) \mathbf{K}_{c,n} = \mathbf{K}_{n,c} \mathcal{T}_n(\{t^{u,v}\}) \mathbf{K}_{n,c}^{-1}$, so that the matrices $\mathcal{T}_n'(\{t^{u,v}\})$ and $\mathcal{T}_n(\{t^{u,v}\})$ are similar and hence, equivalent from an eigenvalue point of view. However, the formulation in (4) is preferred as it allows one to handle Toeplitz blocks for which results recalled in Section II can be used. Notice that $\mathcal{T}_n(\{t^{u,v}\})$ is Hermitian if and only if $\mathbf{T}_n(t^{u,v}) = \mathbf{T}_n^H(t^{u,v})$, $u, v = 1, \dots, c$ or equivalently $t^{v,u}(w) = (t^{u,v}(w))^*$, $u, v = 1, \dots, c$.

B. Asymptotic Distribution of Eigenvalues

Lemma 2 extends straightforwardly to the block Toeplitz matrices in the following:

Lemma 3: For all absolutely summable sequences $\{t_k^{u,v}\}_{k=\dots, -1, 0, 1, \dots}$, there exists a sequence of matrices $\{\mathcal{C}_n(\{t^{u,v}\})\}$ asymptotically equivalent to $\{\mathcal{T}_n(\{t^{u,v}\})\}$ and given by $\mathcal{C}_n(\{t^{u,v}\}) = \mathcal{U}_n^H \mathcal{D}_n(\{t^{u,v}\}) \mathcal{U}_n$ where \mathcal{U}_n is an $nc \times nc$ unitary matrix independent of $\mathcal{T}_n(\{t^{u,v}\})$ and where $\mathcal{D}_n(\{t^{u,v}\})$ is the following matrix

$$\mathcal{D}_n(\{t^{u,v}\}) \triangleq \begin{bmatrix} \mathbf{D}_n(t^{1,1}) & \mathbf{D}_n(t^{1,2}) & \cdots & \mathbf{D}_n(t^{1,c}) \\ \mathbf{D}_n(t^{2,1}) & \mathbf{D}_n(t^{2,2}) & \cdots & \mathbf{D}_n(t^{2,c}) \\ \vdots & \vdots & \ddots & \vdots \\ \mathbf{D}_n(t^{c,1}) & \mathbf{D}_n(t^{c,2}) & \cdots & \mathbf{D}_n(t^{c,c}) \end{bmatrix} \quad (5)$$

where $\mathbf{D}_n(t^{u,v})$ is a diagonal matrix defined as in lemma 2. Notice that $\mathcal{C}_n(\{t^{u,v}\})$ is no longer a circulant matrix, nor is $\mathcal{D}_n(\{t^{u,v}\})$ diagonal.

We next prove a result on the asymptotic eigenvalue moments of block Toeplitz matrices.

Lemma 4:

For all integers $s \geq 1$,

$$\lim_{n \rightarrow \infty} \frac{1}{n} \sum_{k=1}^{cn} \lambda_k^s(\mathcal{T}_n(\{t^{u,v}\}))$$

$$= \frac{1}{2\pi} \int_{-\pi}^{\pi} \sum_{1 \leq k_1, \dots, k_s \leq c} t^{k_1, k_2}(w) t^{k_2, k_3}(w) \cdots t^{k_s, k_1}(w) dw \quad (6)$$

Proof: Because $\mathcal{T}_n(\{t^{u,v}\})$ and $\mathcal{C}_n(\{t^{u,v}\})$ are asymptotically equivalent, thanks to lemma 1, we have

$$\lim_{n \rightarrow \infty} \frac{1}{cn} \sum_{k=1}^{cn} \lambda_k^s(\mathcal{T}_n(\{t^{u,v}\})) = \lim_{n \rightarrow \infty} \frac{1}{cn} \sum_{k=1}^{cn} \lambda_k^s(\mathcal{C}_n(\{t^{u,v}\})).$$

Because $\lambda_k^s(\mathcal{C}_n(\{t^{u,v}\}))$ are all the eigenvalues of $\mathcal{C}_n^s(\{t^{u,v}\})$,

²The Szegő theorem [1], as well as the extensions in [4], [3], [10], were proved under weaker hypotheses on the entries of the Toeplitz matrices. The associated sequences are there supposed to be only square summable. In this case, the Fourier transform is defined differently and the Szegő theorem and its extension are more complicated to prove.

the preceding summation equals the trace of $\mathcal{C}_n^s(\{t^{u,v}\})$, i.e., that of $\mathcal{D}_n^s(\{t^{u,v}\})$. This can be easily proven to be equal to $\sum_{1 \leq k_1, \dots, k_s \leq c} \sum_{k=0}^{n-1} t^{k_1, k_2} \left(\frac{2\pi k}{n}\right) t^{k_2, k_3} \left(\frac{2\pi k}{n}\right) \dots t^{k_s, k_1} \left(\frac{2\pi k}{n}\right)$, and so

$$\begin{aligned} & \lim_{n \rightarrow \infty} \frac{1}{n} \sum_{k=1}^{cn} \lambda_k^s(\mathcal{T}_n(\{t^{u,v}\})) \\ &= \lim_{n \rightarrow \infty} \frac{1}{n} \sum_{1 \leq k_1, \dots, k_s \leq c} \sum_{k=0}^{n-1} t^{k_1, k_2} \left(\frac{2\pi k}{n}\right) \\ & \quad t^{k_2, k_3} \left(\frac{2\pi k}{n}\right) \dots t^{k_s, k_1} \left(\frac{2\pi k}{n}\right) \\ &= \sum_{1 \leq k_1, \dots, k_s \leq c} \lim_{n \rightarrow \infty} \frac{1}{n} \sum_{k=0}^{n-1} t^{k_1, k_2} \left(\frac{2\pi k}{n}\right) \\ & \quad t^{k_2, k_3} \left(\frac{2\pi k}{n}\right) \dots t^{k_s, k_1} \left(\frac{2\pi k}{n}\right). \end{aligned}$$

Thanks to the definition of the Riemann integral where the continuity of the 2π -periodic Fourier transform guarantees the existence, the proof is complete. \blacksquare

If we let $\mathbf{T}(w) \hat{=} \begin{bmatrix} t^{1,1}(w) & \dots & t^{1,c}(w) \\ \vdots & & \vdots \\ t^{c,1}(w) & \dots & t^{c,c}(w) \end{bmatrix}$ (Hermitian

for all w if $\mathcal{T}_n(\{t^{u,v}\})$ is Hermitian), the summation in the right-hand side of (6) is nothing but the trace of $(\mathbf{T}(w))^s$ whose eigenvalues are those of $\mathbf{T}(w)$ to the power of s . Consequently, (6) is equivalent to

$$\begin{aligned} & \lim_{n \rightarrow \infty} \frac{1}{n} \sum_{k=1}^{cn} \lambda_k^s(\mathcal{T}_n(\{t^{u,v}\})) \\ &= \frac{1}{2\pi} \int_{-\pi}^{\pi} \sum_{u=1}^c \lambda_u^s(\mathbf{T}(w)) dw. \end{aligned}$$

Hence, for any polynomial P , we have

$$\begin{aligned} & \lim_{n \rightarrow \infty} \frac{1}{n} \sum_{k=1}^{cn} P(\lambda_k(\mathcal{T}_n(\{t^{u,v}\}))) \\ &= \frac{1}{2\pi} \int_{-\pi}^{\pi} \sum_{u=1}^c P[\lambda_u(\mathbf{T}(w))] dw. \end{aligned}$$

Invoking the Stone-Weierstrass approximation theorem (recalled in [5]), when $\mathbf{T}(w)$ is Hermitian for all w , this relation extends to all functions F continuous on $[\min_w \lambda_c(\mathbf{T}(w)), \max_w \lambda_1(\mathbf{T}(w))]$. Thus, the following result extends Szegő's theorem to block Toeplitz matrices:

Theorem 3: Assume that $\mathcal{T}_n(\{t^{u,v}\})$ is Hermitian; then for all continuous functions F :

$$\begin{aligned} & \lim_{n \rightarrow \infty} \frac{1}{n} \sum_{k=1}^{cn} F(\lambda_k(\mathcal{T}_n(\{t^{u,v}\}))) \\ &= \frac{1}{2\pi} \int_{-\pi}^{\pi} \sum_{u=1}^c F[\lambda_u(\mathbf{T}(w))] dw \end{aligned}$$

Added to the fact that, for all n , the eigenvalues of $\mathcal{T}_n(\{t^{u,v}\})$ lie in $[\min_w \lambda_c(\mathbf{T}(w)), \max_w \lambda_1(\mathbf{T}(w))]$ [4, Theorem 3.1], theorem 3 implies that (see [4], [11]), for any integer l , the lowest (resp., largest) l eigenvalues are convergent in n and

$$\lim_{n \rightarrow \infty} \lambda_{cn-l+1}(\mathcal{T}_n(\{t^{u,v}\})) = \min_w \lambda_c(\mathbf{T}(w)) \quad (7)$$

$$\lim_{n \rightarrow \infty} \lambda_l(\mathcal{T}_n(\{t^{u,v}\})) = \max_w \lambda_1(\mathbf{T}(w)) \quad (8)$$

C. A Class of Block Toeplitz Matrices

We investigate the following special case of block Toeplitz matrices.

Hypothesis H 1: $\mathbf{T}(w)$ has rank 1, for all w .

This is equivalent to have for all w

$$\mathbf{T}(w) = \begin{bmatrix} t^1(w), \dots, t^c(w) \\ t^{1'}(w), \dots, t^{c'}(w) \end{bmatrix}^T |\text{Tr}(\mathbf{T}(w))|$$

where $[t^1(w), \dots, t^c(w)]^T$ and $[t^{1'}(w), \dots, t^{c'}(w)]^T$ are unit-norm left and right singular vectors respectively, associated with the unique non-zero singular value of $\mathbf{T}(w)$. As this singular value is of multiplicity one, it is, as well as the associated singular vectors, a continuous function of $\mathbf{T}(w)$ [12, Th. 1.2.8, p.14]³ which, in turn, is a continuous function of w by construction. Hence, by redefining $t^u(w)$ and $t^{u'}(w)$ to be respectively $\sqrt{|\text{Tr}(\mathbf{T}(w))|} t^u(w)$ and $\sqrt{|\text{Tr}(\mathbf{T}(w))|} t^{u'}(w)$, **H1** is equivalent to the following: there exist continuous functions $t^u(w)$ and $t^{u'}(w)$, with $[t^1(w), \dots, t^c(w)]^T \neq \mathbf{0}$ and $[t^{1'}(w), \dots, t^{c'}(w)]^T \neq \mathbf{0}$ for all w , such that $t^{u,v}(w) = t^u(w)t^{v'}(w)$, for all $u, v = 1, \dots, c$.

As $t^u(w)$ and $t^{u'}(w)$ are continuous, the infinite sequences $\{t_k^u\}_{k=\dots, -1, 0, 1, \dots}$ and $\{t_k^{u'}\}_{k=\dots, -1, 0, 1, \dots}$, obtained as the inverse Fourier transforms of $t^u(w)$ and $t^{u'}(w)$ respectively, $u = 1, \dots, c$, are square summable and not identically zero. **H1** is equivalent to having $t_i^{u,v} = t_i^u * t_i^{v'} = \sum_k t_k^u t_{i-k}^{v'}$, $i = \dots, -1, 0, 1, \dots$, i.e., $t_i^{u,v} = [\dots, t_{-1}^u, t_0^u, t_1^u, \dots] [\dots, t_{i+1}^{v'}, t_i^{v'}, t_{i-1}^{v'}, \dots]^T$. Consequently, the hypothesis **H1** is equivalent to

$$\mathcal{T}_n(\{t^{u,v}\}) = \begin{bmatrix} \mathbf{T}_{(n)}(t^1) \\ \vdots \\ \mathbf{T}_{(n)}(t^c) \end{bmatrix} \begin{bmatrix} \mathbf{T}_{(n)}(t^{1'}) \\ \vdots \\ \mathbf{T}_{(n)}(t^{c'}) \end{bmatrix}^T, \quad (9)$$

where $\mathbf{T}_{(n)}(t^u)$ (resp., $\mathbf{T}_{(n)}(t^{u'})$), $u = 1, \dots, c$, denotes the n rows Toeplitz matrix of first row $[\dots, t_{-1}^u, t_0^u, t_1^u, \dots]$ (resp., $[\dots, t_{-1}^{u'}, t_0^{u'}, t_1^{u'}, \dots]$). Furthermore, if $\mathcal{T}_n(\{t^{u,v}\})$ is Hermitian and positive semi-definite, **H1** is fulfilled iff $t_k^{u'} = (t_{-k}^u)^*$, $u = 1, \dots, c$ or equivalently $\mathbf{T}_{(n)}(t^{u'}) = \mathbf{T}_{(n)}^*(t^u)$, i.e.,

$$\mathcal{T}_n(\{t^{u,v}\}) = \begin{bmatrix} \mathbf{T}_{(n)}(t^1) \\ \vdots \\ \mathbf{T}_{(n)}(t^c) \end{bmatrix} \begin{bmatrix} \mathbf{T}_{(n)}(t^1) \\ \vdots \\ \mathbf{T}_{(n)}(t^c) \end{bmatrix}^H. \quad (10)$$

This preceding condition is frequently encountered in signal processing applications because (10) represents the covariance matrix of a c -variate stationary process obtained by filtering a white scalar stationary process. However, we

³The uniqueness of the left singular vector is guaranteed by limiting the domain of the associated Givens parameterization. So, the application of [12, Th. 1.2.8, p.14] implies the continuity of the individual components of $[t^1(w), \dots, t^c(w)]^T$. The same holds for $[t^{1'}(w), \dots, t^{c'}(w)]^T$.

note that this factorization and thus **H1** is not satisfied for covariance matrices of more general c -variate stationary processes. In the same way, (9) represents the cross-covariance matrix of two c -variate stationary processes obtained by filtering a white complex valued scalar stationary process. With the hypothesis **H1**, the following theorem is straightforwardly proved.

Theorem 4: Assume that $\mathcal{T}_n(\{t^{u,v}\})$ is Hermitian and fulfills **H1**, then for all continuous functions F :

$$\begin{aligned} & \lim_{n \rightarrow \infty} \frac{1}{n} \sum_{k=1}^{cn} F(\lambda_k(\mathcal{T}_n(\{t^{u,v}\}))) \\ &= (c-1)F(0) + \frac{1}{2\pi} \int_{-\pi}^{\pi} F(\sum_{u=1}^c t^{u,u}(w)) dw \end{aligned}$$

IV. APPLICATION TO SIMO CHANNEL IDENTIFICATION

A. Results for the SIMO Channel Filtering Matrix

An m -order SIMO channel, as depicted in Fig. 1, is a set of c filters $\mathbf{h}^i \triangleq [h_0^i, \dots, h_m^i]^T$, $i = 1, \dots, c$, driven by a common scalar input $s(k)$, related to the c -dimensional vector output $\mathbf{x}(k)$ by $\mathbf{x}(k) \triangleq [x^1(k), \dots, x^c(k)]^T = \mathbf{G}(\mathbf{h})\mathbf{s}_{m+1}(k)$ with $\mathbf{s}_{m+1}(k) \triangleq [s(k), \dots, s(k-m)]^T$ and $\mathbf{G}(\mathbf{h}) \triangleq [\mathbf{h}(0) \dots \mathbf{h}(m)]$ where $\mathbf{h}(k) \triangleq [h_k^1 \dots h_k^c]^T$. This setting corresponds to a multi-sensor reception or a poly-phase representation of an over-sampled signal, or a possibly hybrid situation. The SIMO channel order m is defined as the maximum order among those of the different filters $\mathbf{h}^1 \dots \mathbf{h}^c$. n successive output observations are stacked, time by time, into $\mathbf{x}'_n(k) \triangleq [\mathbf{x}^T(k) \dots \mathbf{x}^T(k-(n-1))]^T$ and the covariance matrix is defined as

$\mathbf{R}'_n \triangleq \mathbb{E}[\mathbf{x}'_n(k)\mathbf{x}'_n^H(k)]$. If input $s(k)$ is zero mean and white with variance σ_s^2 then $\mathbf{R}'_n = \sigma_s^2 \mathbf{G}_n(\mathbf{h})\mathbf{G}_n^H(\mathbf{h})$, where

$$\mathbf{G}_n(\mathbf{h}) \triangleq \begin{bmatrix} \mathbf{G}(\mathbf{h}) \mathbf{0} \dots \mathbf{0} \\ \mathbf{0} \mathbf{G}(\mathbf{h}) \dots \mathbf{0} \\ \vdots \\ \mathbf{0} \dots \mathbf{0} \mathbf{G}(\mathbf{h}) \end{bmatrix} \text{ is the } cn \times (n+m) \text{ filtering}$$

matrix and $\mathbf{0}$ is the c -dimensional null vector. Alternatively, the data set can be arranged space/phase by space/phase in the vector $\mathbf{x}_n(k) \triangleq \mathbf{K}_{c,n}\mathbf{x}'_n(k)$. It is straightforwardly proved that $\mathbf{x}_n(k) = \mathbf{H}_n(\mathbf{h})\mathbf{s}_{m+1}(k)$ where

$$\mathbf{H}_n(\mathbf{h}) \triangleq \begin{bmatrix} \mathbf{H}_n(\mathbf{h}^1) \\ \vdots \\ \mathbf{H}_n(\mathbf{h}^c) \end{bmatrix} \text{ and } \mathbf{H}_n(\mathbf{h}^u) \triangleq \begin{bmatrix} \mathbf{h}^{u^T} \mathbf{0} \dots \mathbf{0} \\ \mathbf{0} \mathbf{h}^{u^T} \dots \mathbf{0} \\ \vdots \\ \mathbf{0} \dots \mathbf{0} \mathbf{h}^{u^T} \end{bmatrix} \text{ is}$$

the $n \times (n+m)$ filtering matrix associated with the u -th filter, $u = 1, \dots, c$. $\mathbf{R}_n \triangleq \mathbb{E}[\mathbf{x}_n(k)\mathbf{x}_n^H(k)] = \mathbf{K}_{c,n}\mathbf{R}'_n\mathbf{K}_{c,n} = \sigma_s^2 \mathbf{H}_n(\mathbf{h})\mathbf{H}_n^H(\mathbf{h})$ is hence a block Toeplitz structured matrix that fulfills **H1** and can be written, with respect to notation of Section III, as $\mathbf{R}_n = \sigma_s^2 \mathcal{T}_n(\{h^u h^{v^*}\})$. The application of theorem 4 to \mathbf{R}_n implies that for all continuous functions F , we have

$$\lim_{n \rightarrow \infty} \frac{1}{n} \sum_{k=1}^{cn} F(\lambda_k(\mathbf{R}_n)) = (c-1)F(0)$$

$$+ \frac{1}{2\pi} \int_{-\pi}^{\pi} F\left(\sigma_s^2 \sum_{u=1}^c |h^u(w)|^2\right) dw \quad (11)$$

If $n+m \leq cn$, we let $\sigma_k^{(n)}$, $k = 1, \dots, n+m$, be the k -th largest singular value of $\mathbf{G}_n(\mathbf{h})$ (and of $\mathbf{H}_n(\mathbf{h})$), so that $\lambda_k(\mathbf{R}_n) = (\sigma_k^{(n)})^2$ for $k = 1, \dots, n+m$ and $\lambda_k(\mathbf{R}_n) = 0$ for $k > n+m$. Then (11) gives

$$\begin{aligned} & (c-1)F(0) + \lim_{n \rightarrow \infty} \frac{1}{n} \sum_{k=1}^{n+m} F(\sigma_k^{(n)}) \\ &= (c-1)F(0) + \frac{1}{2\pi} \int_{-\pi}^{\pi} F(\sigma_s^2 \sum_{u=1}^c |h^u(w)|^2) dw. \end{aligned}$$

So, the following theorem is proved.

Theorem 5: For all continuous functions F

$$\begin{aligned} & \lim_{n \rightarrow \infty} \frac{1}{n} \sum_{k=1}^{n+m} F(\sigma_k^{(n)}) \\ &= \frac{1}{2\pi} \int_{-\pi}^{\pi} F\left(\sigma_s \sqrt{\sum_{u=1}^c |h^u(w)|^2}\right) dw \quad (12) \end{aligned}$$

It is interesting to study the asymptotic behavior of the smallest singular value $\sigma_{n+m}^{(n)}$. However, it can not be written as $\lambda_l(\mathbf{R}_n)$ or $\lambda_{nc-l+1}(\mathbf{R}_n)$, for some fixed l and hence we can apply neither (7) nor (8). Only the following is proved:

Theorem 6: If $\min_k \sigma_k^{(n)}$ converges in n , then

$$\lim_{n \rightarrow \infty} \left(\min_k \sigma_k^{(n)}\right) \leq \sigma_s \min_w \left(\sqrt{\sum_{u=1}^c |h^u(w)|^2}\right) \quad (13)$$

Proof: The proof is inspired by that of [4, Corollary 3.9]. We consider the real function $t(w) \triangleq \sigma_s \sqrt{\sum_{u=1}^c |h^u(w)|^2}$ and $m_t \triangleq \min_w t(w)$. We assume $\min_k \sigma_k^{(n)}$ to be convergent to the limit \mathcal{L} when $n \rightarrow \infty$. Suppose that $\mathcal{L} > m_t$. There exist a and b such that $m_t < a < b < \mathcal{L}$. We define the function $F(x) = 1$ if $x \leq a$, $F(x) = 0$ if $x \geq b$. For $x \in [a, b]$, $F(x)$ is chosen so that F is continuous and positive.

There exists an integer N such that for all $n > N$ and all k , $\sigma_k^{(n)} \geq \min_k \sigma_k^{(n)} > b$ and hence, $F(\sigma_k^{(n)}) = 0$. Consequently, the left-hand side of (12) equals 0. The right-hand side, however, equals

$$\begin{aligned} & \frac{1}{2\pi} \int_{-\pi}^{\pi} F(t(w)) dw \\ &= \frac{1}{2\pi} \int_{w \in [-\pi, +\pi] \text{ and } t(w) \leq b} F(t(w)) dw \\ &> \frac{1}{2\pi} \int_{w \in [-\pi, +\pi] \text{ and } t(w) \leq a} F(t(w)) dw \\ &= \frac{1}{2\pi} \int_{w \in [-\pi, +\pi] \text{ and } t(w) \leq a} dw > 0 \end{aligned}$$

Consequently, we must have $\mathcal{L} \leq m_t$. ■

B. Implications for Blind SIMO Channel Identification

The covariance matrix \mathbf{R}_n contains channel phase information and is used to deduce the channel coefficients $\mathbf{h}(k)$, the so called identification problem, for which a variety of second order algorithms (among them the Subspace (SS) [13], the Linear Prediction (LP) [14] and the Outer Product Decomposition (OPD) [15] algorithms) has been developed. They all implicitly or explicitly need inversion of the channel output covariance matrix and hence their performance depends largely on how well-conditioned the matrix is [6], [7]. Hence, its smallest nonzero eigenvalue is critical to the performance of the blind identification algorithm.

We point out that in this context (blind SIMO channel identification), the herein proved result (theorem 3) can be considered more appropriate than that of [16], [17], [18], [19]. The asymptotic results proved therein are established for block Toeplitz matrices with Toeplitz blocks (BTTB) where both the size and number of blocks tend to infinity; while, in this paper, only the size of the blocks n tends to infinity. This is more relevant for stationary processes where n refers to the observation time and c refers to the size of the antenna array and/or the amount of oversampling which naturally are not intended to take large values. However, for other applications such as image processing, covariance matrices of the involved two-dimensional stationary processes are BTTB. The number and size of blocks refer to the spatial samples of the process, possibly large. In this context, results in [16], [17], [18], [19] appear better adapted.

Channel blind identifiability from its second order statistics (i.e. \mathbf{R}_n) requires the SIMO channel to be zero-coprime (i.e. the Z-transforms of the sequences $\{h_k^u, k = 1, \dots, m\}$ do not have any zero in common) and $n \geq m$. Under such conditions, $\mathbf{G}_n(\mathbf{h})$ has full column rank [20] and the left-hand side of (13) expresses the square root of the asymptotic lowest nonzero eigenvalue of \mathbf{R}_n . When observed over finite time intervals and in the presence of noise, the above is insufficient and the channel needs to exhibit enough *diversity* to allow for accurate response estimation. Channel diversity has often been described as the closeness in the Z plane of the zeros of the subchannels transfer functions [21]. This definition is rather subjective and counter-examples can be found where a channel has closer zeros while its covariance matrix is better conditioned. We, therefore, suggest the left-hand side of (13) as an algorithm-independent *measure* of the channel diversity. Indeed, it approximates well the square root of the lowest nonzero eigenvalue of \mathbf{R}_n for practical values of n .

The upper bound in (13) is better suited to assess channel blind (un)identifiability under practical observation conditions. In fact, in cases where the right-hand side in (13) is small, the channel output covariance matrix is poorly conditioned and blind algorithms are expected to fail to identify the channel if its output is observed over a limited time duration. This bound has also the advantage of giving a spectral interpretation of channel diversity.

This bound has a further interpretation in the practi-

cal case when the channel response includes small heading and/or trailing terms (Fig. 2). The whole m -order channel response \mathbf{h} can be written as the sum of an m' -order effective response $\mathbf{h}_{m'}$, $m' < m$, and a perturbation vector due to the small trailing terms [22]. If we let $h_{m'}^u(w)$ be the Fourier transform associated with the subchannel $u = 1, \dots, c$ of $\mathbf{h}_{m'}$, then $\sum_{u=1}^c |h^u(w)|^2 \simeq \sum_{u=1}^c |h_{m'}^u(w)|^2$ i.e., the bound in (13) is approximately the same when evaluated for \mathbf{h} or $\mathbf{h}_{m'}$. When this bound is weak, it implies poor diversity of the whole response as well as the effective response. In such case, the channel will not be identifiable whatever the assumed channel order. When assumed to be $> m'$, it leads to a badly conditioned covariance matrix because of the small trailing terms. When $< m'$, the identification procedure will fail because some significant terms were ignored. When equal to m' , blind identification is still not possible because of the bound (and hence channel diversity) being weak. Hence, while generally not tight as verified through computations, the upper bound in (13), when low, indicates *absolute non identifiability* of the channel i.e., nor the channel or a part of it can be identified from a finite observation set. Examples are given in the practical case of fractionally received bandlimited channels.

C. Fractionally Spaced Bandlimited Channels

We now focus on fractionally spaced bandlimited channels. If subchannels $h^k(w)$, $k = 1, \dots, c$ are issued from the oversampling of a waveform $h(t)$, then $h^k(w) = \sum_l h(w - 2l\pi)e^{-j(w-2l\pi)\frac{k-1}{c}}$ where $h(w) \triangleq \int h(t)e^{-jw t} dt$. When $h(t)$ is bandlimited (to $[-\frac{1}{T}, \frac{1}{T}]$), then

$h^k(w) = h(w)e^{-jw\frac{k-1}{c}} + h(w - 2\pi)e^{-j(w-2\pi)\frac{k-1}{c}}$ for $w \in [0, 2\pi]$ and it can be proved that (13) simplifies to

$$\lim_{n \rightarrow \infty} \left(\min_k \sigma_k^{(n)} \right) \leq \sigma_s \sqrt{c} \min_w \left(\sqrt{|h(w)|^2 + |h(w - 2\pi)|^2} \right)$$

More commonly, $h(w)$ is a bandlimited shaping filter response (a raised cosine waveform most often) propagating through a frequency selective multipath channel. Because of severe selectivity, some frequency components can be significantly attenuated leading to the upper bound above to be weak. This justifies the poor performance of blind algorithms in identifying communication channels using fractional receivers, and concurs with remarks in [23]⁴.

A series of simulations was conducted with a raised cosine waveform⁵ with rolloff 0.3, propagating through randomly selected multipath channels with a 4 symbol period delay spread⁶. Channels for which the upper bound of (13) was weak (≤ 0.1), such as in Fig. 3, were systematically *absolutely non identifiable*⁷ in the sense given in Section

⁴The therein made analysis, however, is algorithm dependent (subspace algorithm) and uses sophisticated mathematics (spheroidal wave sequences).

⁵The waveform response was truncated over 40 symbol periods.

⁶The direct path is not delayed and not attenuated while the number, delays and attenuations of the weaker and delayed paths are randomly chosen. The channel response was normalized so that $\|\mathbf{h}\| = 1$

⁷Identification was tried using the subspace algorithm. The channel was observed over 300 symbol periods with an SNR of 20dB and was T/2 sampled. The channel was declared non identified when the mean

IV-B. On the contrary, however, when the upper bound of (13) was not weak, no conclusion can be made. An order with which reliable identification can be performed may exist (Fig. 4) or not (Fig. 5).

V. CONCLUSION

We have given a new and simpler proof, inspired by that in [5], of Szegő's theorem extension to block Toeplitz matrices [2]. Block Toeplitz matrices are encountered in signal processing as covariance matrices that always verify some factorization properties. We exploited these properties to get a simpler form of Szegő's theorem extension and derive results about the asymptotic behavior of their lowest nonzero eigenvalue. Application to single input multiple output (SIMO) channels can help justifying cases where the channel covariance matrix is poorly conditioned resulting in poor performance of the blind identification algorithms; as is shown to be practically the case of fractionally spaced bandlimited channels.

REFERENCES

- [1] Ulf Grenander and Gabor Szegő, *Toeplitz Forms and Their Applications*. Chelsea publishing company, N. Y., 1984.
- [2] Paolo Tilli, "Asymptotic Spectral Distribution of Toeplitz-Related Matrices," in *Fast Reliable Algorithms for Matrices with Structure*, T. Kailath and A. H. Sayed Ed. SIAM, 1999, pp. 153-187.
- [3] Paolo Tilli, "Singular values and eigenvalues of non-Hermitian block Toeplitz matrices," *Linear Algebra and its Applications*, 272, pp. 59-89, 1998.
- [4] Michele Miranda and Paolo Tilli, "Asymptotic Spectra of Hermitian Block Toeplitz Matrices and Preconditioning Results," *SIAM Journal on Matrix Analysis and Applications*, vol. 21, no. 3, pp. 867-881, 2000.
- [5] Robert Molten Gray, "On the Asymptotic Eigenvalue Distribution of Toeplitz Matrices," *IEEE Trans. Information Theory*, vol. 18, no. 6, pp. 725-730, Nov. 1972.
- [6] Alle-Jan van der Veen, "Resolution Limits of Blind Multi-user Multi-channel Identification Schemes - The Bandlimited Case," in Proc. IEEE ICASSP, 1996, vol. 5, pp. 2722-2727.
- [7] A. P. Liavas, P. A. Regalia and J.P. Delmas, "Robustness of least squares and subspace methods for blind channel identification/equalization with respect to effective channel undermodeling," *IEEE Trans. Signal Processing*, vol. 47, no. 6, pp. 1636-1645, Jun. 1999.
- [8] Harold V. Henderson and S. R. Searle, "The Vec-Permutation Matrix, the Vec Operator and Kronecker Products: A Review," *Linear and Multilinear Algebra*, vol. 9, pp. 271-288, 1981.
- [9] Robert Molten Gray. (2000 Mar.). Toeplitz and Circulant Matrices: A review. Information Theory Laboratory, Stanford University, CA. [Online]. Available: <http://www-isl.stanford.edu/gray/compression.html>
- [10] Evgenij E. Tyrtyshnikov, "A Unifying Approach to Some Old and New Theorems on Distribution and Clustering," *Linear Algebra and its Applications*, 232, pp. 1-43, 1996.
- [11] Michele Miranda and Paolo Tilli, "Block Toeplitz Matrices and Preconditioning," *Calcolo*, 33, pp. 79-86, 1996.
- [12] Åke Björck, *Numerical Methods for Least Squares Problems*. SIAM, 1996.
- [13] Eric Moulines, Pierre Duhamel, Jean Francois Cardoso and Sylvie Mayrargue, "Subspace Methods for the Blind Identification of Multichannel FIR Filters," *IEEE Trans. Signal Processing*, vol. 43, no. 2, pp. 516-525, Feb. 1995.
- [14] Karim Abed-Meraim, Eric Moulines and Philippe Loubaton, "Prediction Error Method for Second-Order Blind Identification," *IEEE Trans. Signal Processing*, vol. 45, no. 3, pp. 694-705, Mar. 1997.
- [15] Zhi Ding, "Matrix Outer Product Decomposition Method for Blind Multiple Channel Identification," *IEEE Trans. Signal Processing*, vol. 45, no. 12, pp. 3053-3061, Dec. 1997.
- [16] Paul A. Voois, "A Theorem on the Asymptotic Eigenvalue Distribution of Toeplitz-Block-Toeplitz Matrices," *IEEE Trans. Signal Processing*, vol. 44, no. 7, pp. 1837-1841, Jul. 1996.
- [17] N. K. Bose and K. J. Boo, "Asymptotic Eigenvalue Distribution of Block-Toeplitz Matrices," *IEEE Trans. Information Theory*, vol. 44, no. 2, pp. 858-861, Mar. 1998.
- [18] Stefano Serra, "On the Extreme Eigenvalues of Hermitian (Block) Toeplitz Matrices," *Linear Algebra and its Applications*, 270, pp.109-129, 1998.
- [19] Paolo Tilli, "On the Asymptotic Spectrum of Hermitian Block Toeplitz Matrices with Toeplitz Blocks," *Mathematics of Computation*, vol. 6, no. 219, 1997, pp. 1147-1159.
- [20] Lang Tong, Guanghan Xu and Thomas Kailath, "Blind Identification and Equalization Based on Second-Order Statistics: A Time Domain Approach," *IEEE Trans. Information Theory*, vol. 40, no. 2, pp. 340-349, Mar. 1994.
- [21] Inbar Fijalkow, Azzèdine Touzni and John R. Treichler, "Fractionally Spaced Equalization Using CMA: Robustness to Channel Noise and Lack of Disparity," *IEEE Trans. Signal Processing*, vol. 45, no. 1, pp. 56-66, Jan 1997.
- [22] A. P. Liavas, P. A. Regalia and J.P. Delmas, "Blind channel approximation: Effective channel order determination," *IEEE Trans. Signal Processing*, vol. 47, no. 12, pp. 3336-3344, Dec. 1999.
- [23] Ph. Ciblat and Ph. Loubaton, "Second Order Blind Equalization : The Bandlimited Case," in Proc. IEEE ICASSP, 1998.

square error exceeds 0.1.

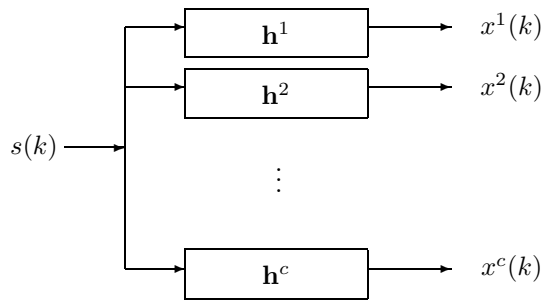

Fig. 1. Single input multiple output channel

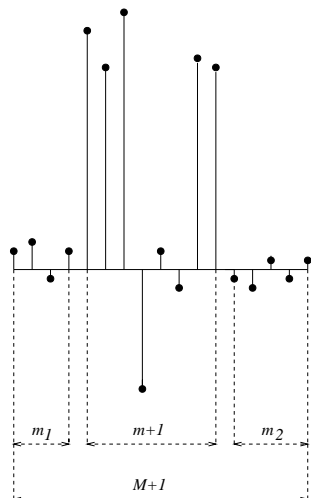
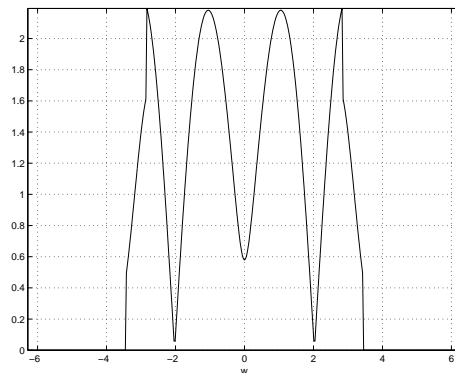
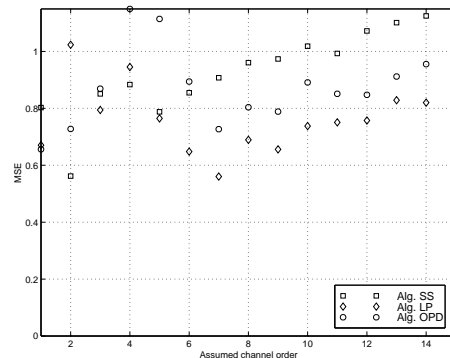

Fig. 2. Channel response with small heading and trailing terms



(a) Frequency response $h(w)$



(b) Blind identification error

Fig. 3. Respectively, path delays $0, 1.0341 T, 1.1826 T, 1.3605 T, 1.8780 T, 1.9039 T, 2.1689 T, 2.2460 T, 3.3337 T, 3.4301 T, 3.7009 T$ and $4 T$ and attenuations $1, 0.9868, -0.3123, -0.3661, -0.6635, 0.6918, -0.4045, 0.5188, -0.4929, -0.7333, -0.0459$ and $.6$. The upper bound in (13) equals 0.0851 .

Houcem GAZZAH was born in Sousse, Tunisia, in 1971. He received the B. E. degree from Ecole Supérieure des Communications, Tunis, Tunisia in 1995, the M. S. and the Ph. D. degrees from Ecole Nationale Supérieure des Télécommunications, Paris, France, in 1997 and 2000 respectively. He is currently a research associate at Institut National des Télécommunications, Evry, France. His research interests include statistical signal processing, blind identification and equalization and multivariate processes.

Phillip A. Regalia was born in Walnut Creek, CA. He received the the B.Sc. (Highest Honors), M.Sc., and Ph.D. degrees in electrical and computer engineering from the University of California at Santa Barbara in 1985, 1987, and 1988, respectively, and the Habilitation à Diriger des Recherches from the University of Paris at Orsay.

He is presently a Professor at the Institut National des Télécommunications in Evry, France, with research inter-

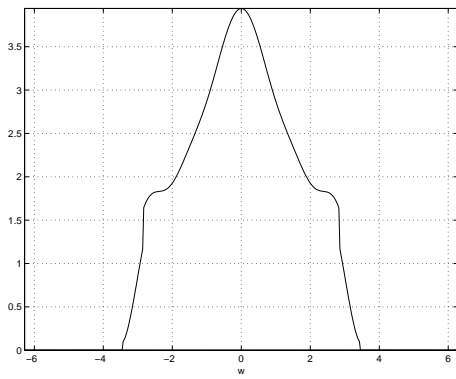

(a) Frequency response $h(w)$

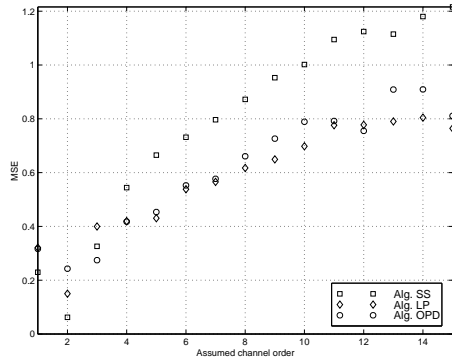

(b) Blind identification error

Fig. 4. Frequency response $h(w)$. Respectively, path delays 0, 0.0470 T , 0.5461 T , 1.0093 T , 1.0858 T , 2.9492 T , 3.5756 and 4 T and attenuations 1, 0.8381, 0.4418, 0.3689, 0.8672, 0.6775, -0.6518 and 0.4. The upper bound in (13) equals 1.0690.

ests focused in adaptive signal processing and algorithm design.

Dr. Regalia has served as an associate editor with the IEEE Transactions on Circuits and Systems II, the IEEE Transactions on Signal Processing, and the International Journal of Adaptive Control and Signal Processing.

Jean Pierre Delmas was born in France in 1950. He received the engineering degree from Ecole Centrale de Lyon in 1973 and the Certificat d'études supérieures from the Ecole Nationale Supérieure des Télécommunications in 1982. Since 1980 he has been with the Institut National des Télécommunications where he is currently Maitre de conférences. His teaching and research interests include Statistical Signal Processing.

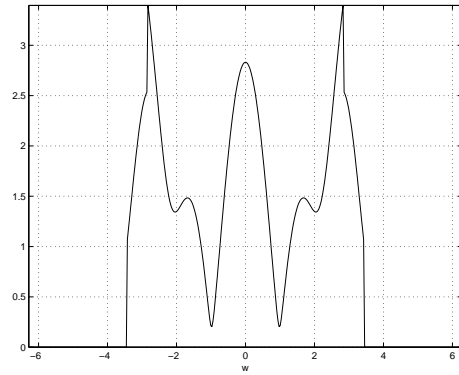

(a) Frequency response $h(w)$

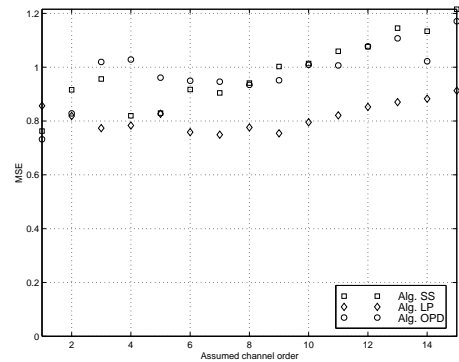

(b) Blind identification error

Fig. 5. Frequency response $h(w)$. Respectively, path delays 0, 0.0611 T , 0.7949 T , 0.7953 T , 1.0888 T , 1.6746 T , 1.7804, 1.8640, 2.4152, 2.9871, 3.7273 and 4 T and attenuations 1, 0.4952, 0.6583, -0.8267, -0.9669, 0.8591, 0.8911, -0.6676, 0.5272, -0.0201, 0.4824 and 0.4. The upper bound in (13) equals 0.3033.